

B1

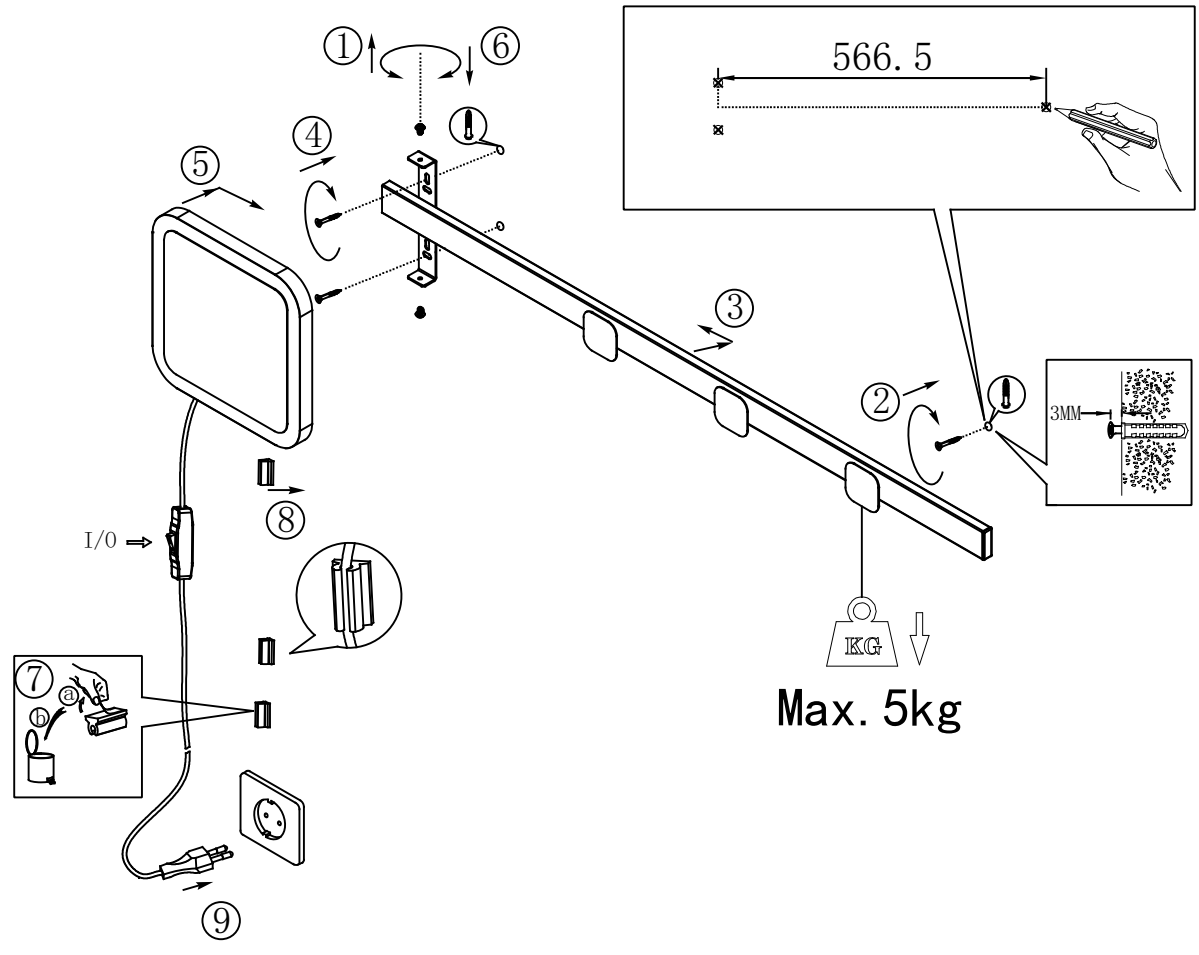

B2

