



SaniSupreme
Betaalbaar Design

Installatie instructie

SHOWER SYSTEM



INSTALLATION MANUAL



2308

BEFORE YOU BEGIN

We recommend consulting a professional if you are unfamiliar with installing plumbing fixtures. Signature Hardware accepts no liability for any damage to the plumbing, floor, walls, tub, or for personal injury during installation.

Observe all local plumbing and building codes.

Unpack and inspect the items for shipping damage. If any damage is found, contact our Customer Relations team.

GETTING STARTED

- Ensure that you have gathered all the required materials that are needed for the installation.
- For the following installation instructions, it is assumed that the wall has been opened and that the existing shower set has been removed.
- Before you begin, the main water supply to your home should be shut off.

TOOLS AND MATERIALS:



Plumber's
Tape



Tape Measure



Hex Wrench



Level



Adjustable
Wrench



Drill



Wood Blocking



Soldering Kit
(for copper pipes)



1/2" Ball Plug

SHOWER SET INSTALLATION

Step 1: Valve Installation

1. To prepare for installation, wood blocking should be installed between the two studs where the valve will mount. Use the guide printed on the valve's protective sleeves as a reference when installing the wood blocking.

Important: Take into consideration the thickness of the finished wall materials, such as tile, when calculating measurements. If the finished wall extends beyond the maximum guideline marked, the trim pieces will not install.



2. Secure the valve to the prepared wood blocking using the provided hardware. Ensure that the hot outlet is pointing to the left and the cold outlet is pointing to the right. Use a level to ensure that the valve is installed straight.

Tip: Leave the protective sleeves on the valve stems until your finished wall is complete, and you are ready to install the trim pieces.

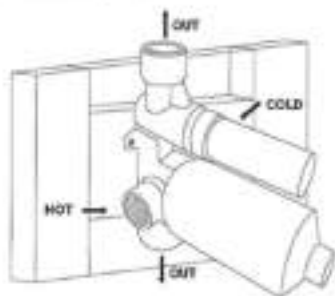

3. Route, assemble and connect in-wall piping to and from the shower valve. Make connections appropriately depending upon the type of pipe that is being used. For copper pipe, soldering will be required and should be completed by a licensed plumber. Apply plumber's tape to any threaded connections if applicable. Install any wood blocking that is necessary to support the piping and valve.

Notes:

- Female fittings will need to be installed where the hand shower's cradle and the shower arm will mount.
- The piping for the overhead shower should be connected to the bottom outlet of the rough-in valve. Piping for the hand held shower should connect to the top.

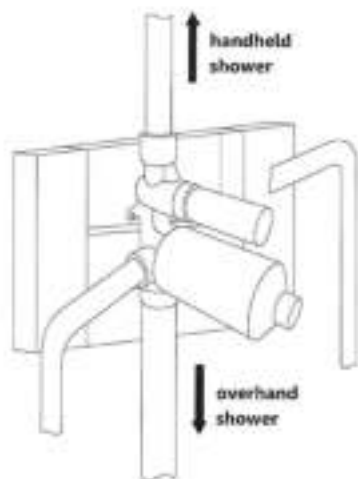

SHOWER SET INSTALLATION

4. Once all piping is routed and connections have been made, use a 1/2" test plate to perform a water pressure test. Turn on the main water supply to your home and water test the installed plumbing. Ensure that there are no leaks, then shut the water off. Remove the test plug.

Note: Water pressure testing should be performed by a licensed plumber if you are not familiar with this procedure.



IMPORTANT: COMPLETE THE CONSTRUCTION OF YOUR WALL, INCLUDING ANY FINISHED WALL MATERIALS SUCH AS TILE, BEFORE PROCEEDING WITH THE REMAINDER OF THE INSTALLATION.



Step 2: Trim Installation

1. Once the finished wall is complete, remove the protective sleeves from the valve. If the test plug has not yet been removed, remove that as well.

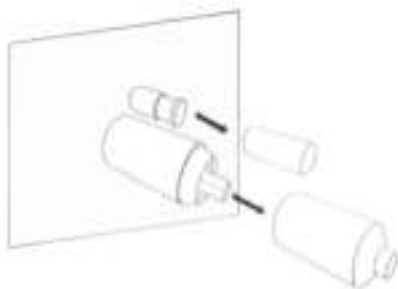

2. Slide the decorative back plate onto the valve.

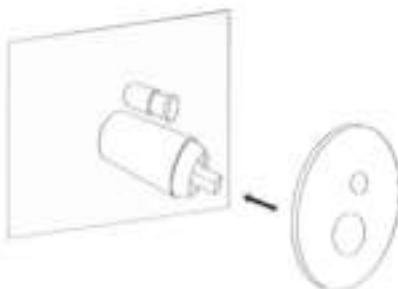

SHOWER SET INSTALLATION

3. Remove the decorative screw cover from the valve handle. Slide the hand le into the valve stem and secure it by tightening the set screw with the provided hex wrench. Reinstall the screw cover to conceal the screw.

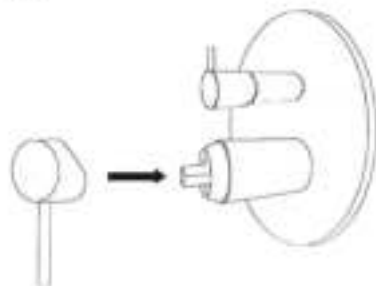

4. Install the hand shower cradle by threading it into its prepared female fitting. Apply thread sealant or plumber's tape to the threads before tightening. Hand tighten firmly.

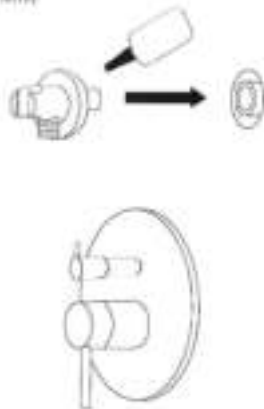

5. Attach the hand shower to the cradle using the hand shower hose. Insert one of the provided rubber O-rings into each end of the hose, and apply thread sealant or plumber's tape to the threads before tightening. Hand tighten the connections firmly.



6. Slide the decorative back plate onto the shower arm, and install the shower arm by threading it into its prepared female fitting. Apply thread sealant or plumber's tape to the threads before tightening. Hand tighten firmly.



SHOWER SET INSTALLATION

7. Install the shower head using the provided swivel joint. Apply thread sealant or plumber's tape to the threads before tightening. Once secure, tighten the set screw located on the swivel joint using the provided hex wrench.

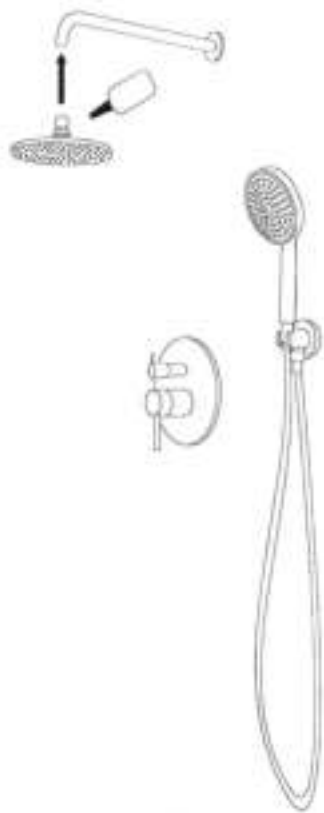

8. Turn the main water supply back on, and test the completed shower system. Ensure that there are no leaks and that all functions are working properly.

