

Lara²

0 M – <48 M /

Max 22 kg



MAXI-COSI[®]

We carry the future



EN
IMPORTANT
READ CAREFULLY AND KEEP FOR FUTURE REFERENCE.

FR
IMPORTANT
À LIRE ATTENTIVEMENT ET À CONSERVER POUR
RÉFÉRENCE ULTÉRIEURE.

DE
WICHTIG
BITTE SORGFALTIG LESEN UND FÜR SPÄTERES NACHLESEN
UNBEDINGT AUFBEWAHREN.

NL
BELANGRIJK
LEES ZORGVULDIG EN BEWAAR ALS REFERENTIE VOOR
EEN LATER GEBRUIK.

IT
IMPORTANTE
LEGGERE CON ATTENZIONE E CONSERVARE PER
CONSULTAZIONE FUTURA.



SV
VIKTIGT
LÄS NOGGRANT OCH SPARA FÖR FRAMTIDA BRUK.

DA
VIGTIGT
LÆSES OMHYGGELIGT OG GEMMES TIL FREMTIDIG BRUG.

FI
TÄRKEÄÄ
LUE HUOLELLISESTI JA SÄILYTÄ TULEVAA KÄYTTÖÄ
VARTEN.

PL
WAŻNE
NALEŻY UWAŻNIE ZAPOZNAĆ SIĘ Z INSTRUKCJĄ OBSŁUGI
I ZACHOWAĆ JĄ NA PRZYSZŁOŚĆ.

NO
VIKTIG
LES NØYE OG TA VARE PÅ FOR SENERE REFERANSE.



RU

ВАЖНО

**ВНИМАТЕЛЬНО ПРОЧИТАЙТЕ И СОХРАНИТЕ
ЭТО РУКОВОДСТВО ДЛЯ ПОСЛЕДУЮЩЕГО
ИСПОЛЬЗОВАНИЯ.**

TR

ÖNEMLİ

**DİKKATLE OKUYUN VE GELECEKTE REFERANS OLMASI İÇİN
SAKLAYIN.**

HR

VAŽNO

PAŽLJIVO PROČITAJTE I SAČUVAJTE ZA SLUČAJ POTREBE.

SK

DÔLEŽITÉ

**POZORNE SI PREČÍTAJTE A USCHOVAJTE PRE BUDÚCU
POTREBU.**

BG

ВАЖНО

**ПРОЧЕТЕТЕ ВНИМАТЕЛНО И ЗАПАЗЕТЕ ЗА БЪДЕЩИ
СПРАВКИ.**



UK

ВАЖЛИВА ІНФОРМАЦІЯ

УВАЖНО ПРОЧИТАЙТЕ І ЗБЕРЕЖІТЬ ЦІ ІНСТРУКЦІЇ
ДЛЯ ЗВЕРНЕННЯ У МАЙБУТНЬОМУ.

HU

FONTOS

ŐRIZZE MEG AZ ALÁBBI ÚTMUTATÓT JÖVŐBELI
HIVATKOZÁS CÉLJÁBÓL.

SL

POMEMBNO

POZORNO PREBERITE IN SHRANITE ZA POZNEJŠO
UPORABO.

ET

OLULINE

LUGEGE HOOLIKALT JA HOIDKE ALLES.

CZ

DŮLEŽITÉ

POZORNĚ PŘEČTĚTE A USCHOVEJTE PRO BUDOUCÍ
POTŘEBU.



EL
ΣΗΜΑΝΤΙΚΟ
ΔΙΑΒΑΣΤΕ ΠΡΟΣΕΚΤΙΚΑ ΚΑΙ ΦΥΛΑΞΤΕ ΤΟ ΓΙΑ
ΜΕΛΛΟΝΤΙΚΗ ΑΝΑΦΟΡΑ.

RO
IMPORTANT
CITIȚI CU ATENȚIE ȘI PĂSTRAȚI PENTRU CONSULTĂRI
ULTERIOARE.

HE

חשוב
קראו בעיון רב ושמרו לעיון בעתיד.

AR

هام
اقرأ بتمعن واحفظه لمراجعتك مستقبلا.

EN Non-contractual photos FR Photos non contractuelles DE Fotos nicht bindend NL Niet-contractuele foto's
IT Foto non contrattuali SV Bilderna kan avvika från den faktiska produkten DA Ikke-kontraktlige billeder FI Kuvat
eivät ole sitovia PL Użyte zdjęcia służą tylko do prezentacji jako przykład NO Bilder kan avvike fra det faktiske
produkt RU Фотография может отличаться от товара TR Fotoğraflar bağlayıcı değildir HR Neobvezujuće
fotografije SK Skutočný výrobok sa môže od vyobrazeného líšiť BG Извъндоговорни снимки UK Фотографії,
які не тягнуть договірних зобов'язань HU Tájékoztató jellegű fotók SL Nepogodbene fotografije
ET Lepinguvälised pildid CZ Nesmluvní fotografie EL Οι εικόνες που χρησιμοποιούνται στον παρόντα
οδηγό ενδέχεται να διαφέρουν από το πραγματικό προϊόν RO În funcție de model HE ממונות לא חוזיות
AR الصور غير التعاقدية

EN

INSTRUCTIONS FOR USE

FR

MODE D'EMPLOI

DE

GEBRAUCHSANWEISUNG

NL

GEBRUIKSAANWIJZING

IT

ISTRUZIONI D'USO

SV

ANVÄNDARINSTRUKTIONER

DA

BRUGSANVISNING

FI

KÄYTTÖOHJEET

PL

INSTRUKCJA OBSŁUGI

NO

BRUKSANVISNING

RU

ИНСТРУКЦИЯ ПО ПРИМЕНЕНИЮ

TR

KULLANIM TALIMATLARI

HR

UPUTSTVO ZA UPORABU

SK

INŠTRUKCIE NA POUŽITIE

BG

ИНСТРУКЦИИ ЗА УПОТРЕБА

UK

ІНСТРУКЦІЯ ПО ЗАСТОСУВАННЮ

HU

HASZNÁLATI UTASÍTÁSOK

SL

NAVODILA ZA UPORABO

ET

KASUTUSJUHEND

CZ

INSTRUKCE K POUŽITÍ

EL

ΟΔΗΓΙΕΣ ΧΡΗΣΕΩΣ

RO

INSTRUCȚIUNI DE UTILIZARE

AR

ل ا م ع ت س ا ل ا ت ا م ي ل ع ت

HE

הוראות שימוש

Index



10



31



11



36



17



38



20



42



23



49





EN	Assembling	HR	Sastavljanje
FR	Montage	SK	Montáž
DE	Montage	BG	Монтиране
NL	Montage	UK	Монтаж
IT	Montaggio	HU	Szerelés
SV	Montering	SL	Montaža
DA	Montering	ET	Komplekteerimine
FI	Asennus	CZ	Montáž
PL	Montaż	EL	Συναρμολόγηση
NO	Montering	RO	Asamblar
RU	Сборка	HE	הרכבה
TR	Montaj	AR	التجميع

www.maxi-cosi.com



1.

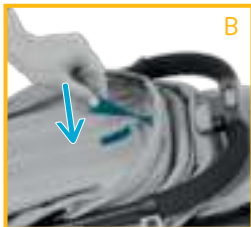
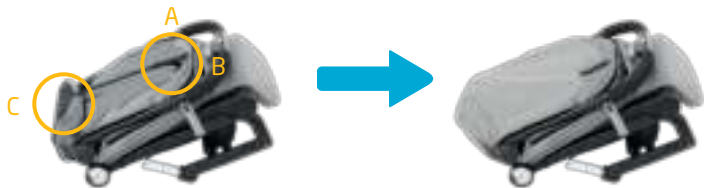



2.

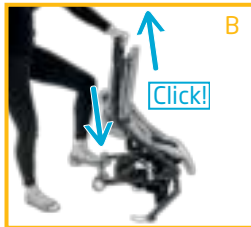
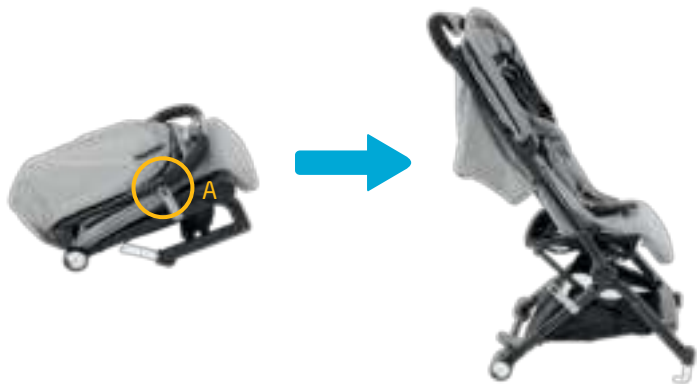



3.

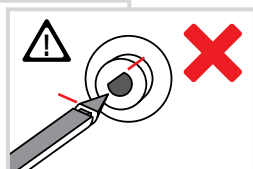
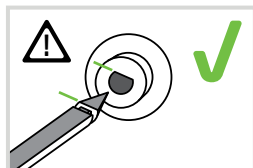
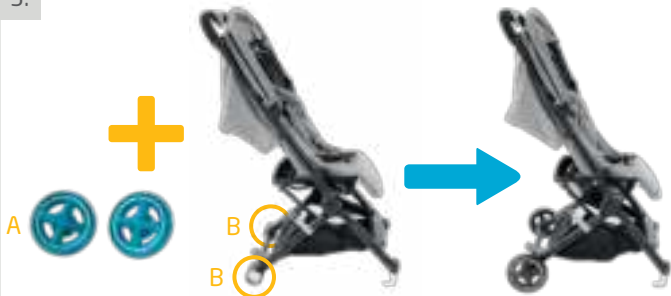



4.

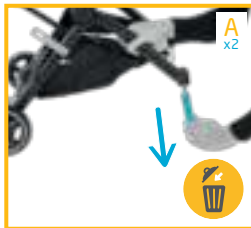
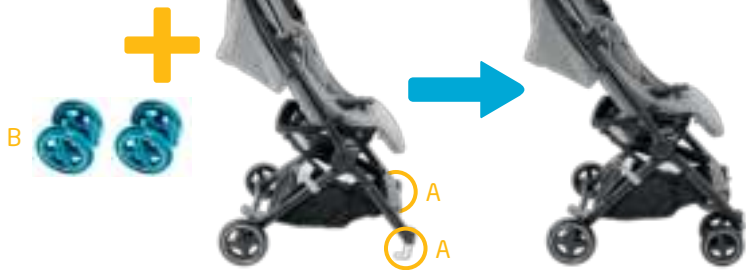



5.

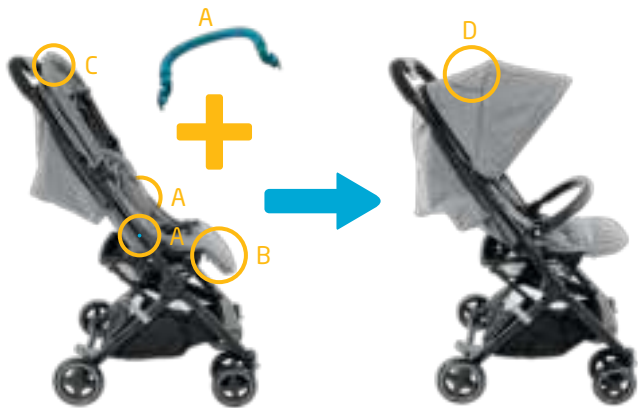

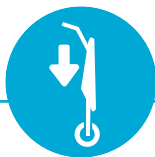

EN	Folding	HR	Sklapanje
FR	Pliage	SK	Skladanie
DE	Zusammenfalten	BG	Сгъване
NL	Invouwen	UK	Складання
IT	Chiusura	HU	Összecsukás
SV	Ihopfälld	SL	Zlaganje
DA	Sammenfoldning	ET	Kokkupanemine
FI	Kokoon taittaminen	CZ	Skládání
PL	Składanie	EL	Κλείσιμο
NO	Sammenlegging	RO	Pliere
RU	Складывание	HE	קיפול
TR	Katlanma	AR	الطيّ

www.maxi-cosi.com



1.

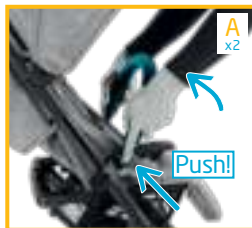



2.

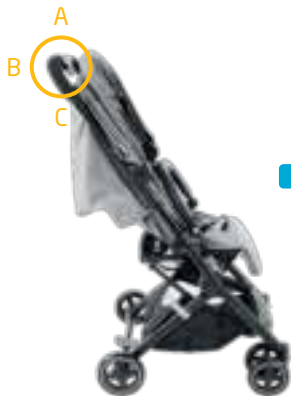



EN	Unfolding	HR	Rasklapanje
FR	Dépliage	SK	Rozkladanie
DE	Aufklappen	BG	Разгъване
NL	Uitvouwen	UK	Розкладання
IT	Apertura	HU	Szétnyitás
SV	Fälla upp	SL	Razpiranje
DA	Udfoldning	ET	Avamine
FI	Kasaaminen	CZ	Rozkládání
PL	Rozkładanie	EL	Άνοιγμα
NO	Oppsetting	RO	Depliere
RU	Раскладывание	HE	פתיחה
TR	Açılma	AR	البيسط

www.maxi-cosi.com



1.

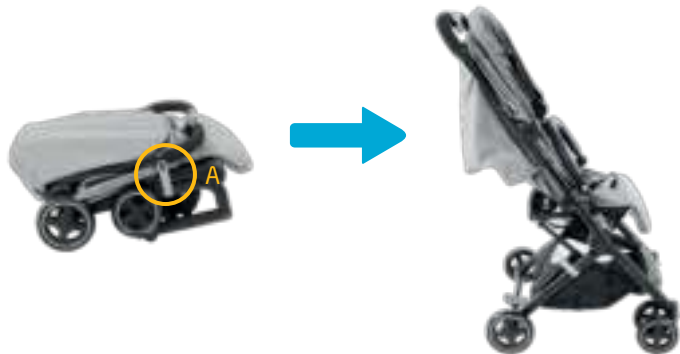



2.





EN	Use	HR	Uporaba
FR	Usage	SK	Použitie
DE	Verwendung	BG	Употреба
NL	Gebruik	UK	Використання
IT	Utilizzo	HU	Használat
SV	Användning	SL	Uporaba
DA	Brug	ET	Kasutamine
FI	Käyttö	CZ	Použití
PL	Użytkowanie	EL	Χρήση
NO	Bruk	RO	Folosire
RU	Использование	HE	שימוש
TR	Kullanım	AR	الاستخدام

www.maxi-cosi.com



1.

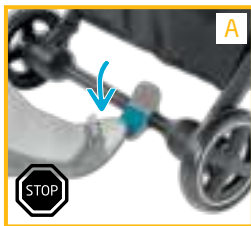



2.

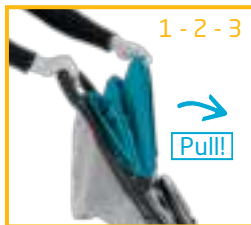



3.

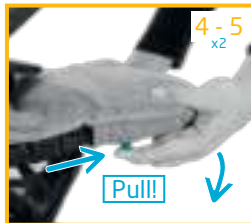
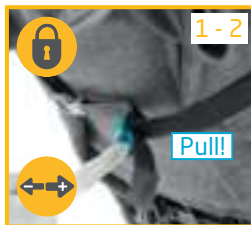



4.

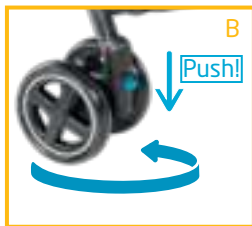
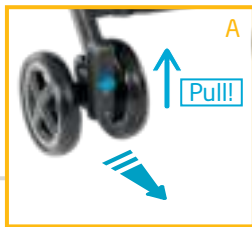



5.







6.

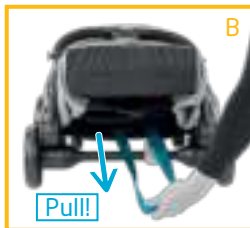



EN	Child installation	HR	Stavljanje djeteta
FR	Installation de l'enfant	SK	Inštalácia pre deti
DE	Anschnallen des Kindes	BG	Монтиран продукт за деца
NL	Plaatsen van het kind	UK	Розміщення дитини
IT	Accomodare il bambino	HU	Gyermekek behelyezése
SV	Placera barnet	SL	Namestitev otroka
DA	Barneinstallation	ET	Lapse paigutamine
FI	Lapsen asettaminen	CZ	Umístění dítěte
PL	Umieszczanie i zabezpieczanie dziecka	EL	Τοποθέτηση του παιδιού
NO	Plassering av barnet	RO	Introducerea copilului
RU	Размещение ребенка	HE	הושבת הילד
TR	Çocuğun yerleştirilmesi	AR	تنشيت الطفل

www.maxi-cosi.com



1.

0 M / Max 22 kg

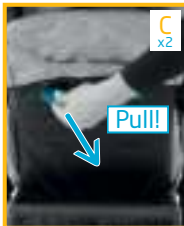
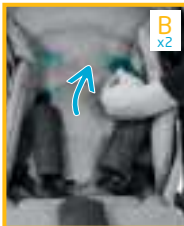





2.

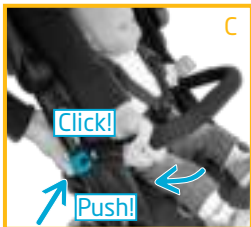
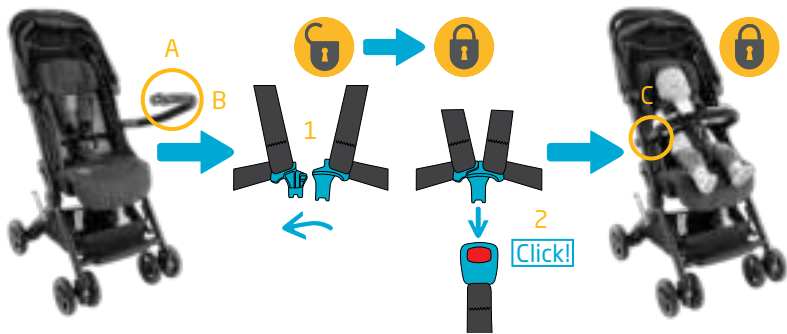



3.

R

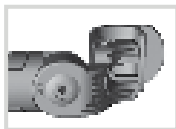

L

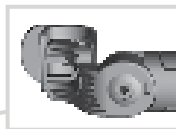



EN	Box content	HR	Sadržaj kutije
FR	Inclus dans le carton	SK	Obsah krabice
DE	Kartoninhalt	BG	Съдържание на кутията
NL	Inhoud	UK	Вміст упаковки
IT	Contenuto della confezione	HU	Doboz tartalma
SV	Förpackningens innehåll	SL	Vsebina kartona
DA	Æskens indhold	ET	Karbi sisu
FI	Pakkauksen sisältö	CZ	Obsah balení
PL	Zawartość opakowania	EL	Περιεχόμενα κουτιού
NO	Eskens innhold	RO	Conținutul cutie
RU	Содержимое упаковк	HE	תכולת האריזה
TR	Kutu içeriği	AR	محتوى العلبه

www.maxi-cosi.com

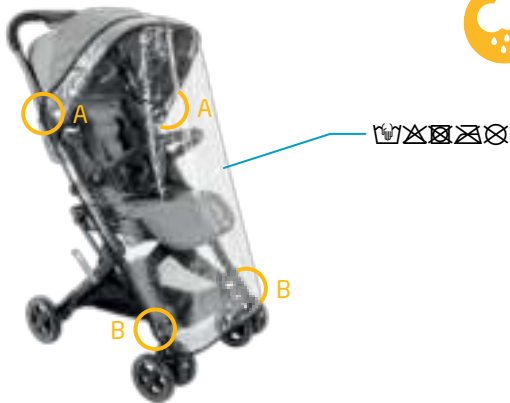



EN	Accessories sold separately	HR	Dodaci se prodaju zasebno
FR	Accessoires vendus séparément	SK	Príslušenstvo sa predáva zvlášť
DE	Separat erhältliches Zubehör	BG	Акcesoарите се продават отделно
NL	Accessoires worden apart verkocht	UK	Акcesуари продаються окремо
IT	Accessori venduti separatamente	HU	Külön forgalmazott kellékek
SV	Tillbehör säljs separat	SL	Dodatki naprodaj posebej
DA	Tilbehør der sælges separat	ET	Lisatarvikuid müüakse eraldi
FI	Erikseen myytävät lisävarusteet	CZ	Doplňky prodávané samostatně
PL	Akcesoria sprzedawane oddziel	EL	Εξαρτήματα που πωλούνται χωρι
NO	Tilleggsutstyr som selges separa	RO	Accesorii vândute separat
RU	Аксессуары продаются отдельно	HE	אביזרים הנמכרים בנפרד
TR	Aksesuarlar ayrı satılır	AR	الملحقات المباعة بشكل منفصل

www.maxi-cosi.com





0 - 6 M

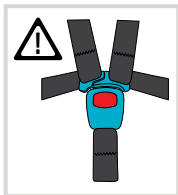

+6 M

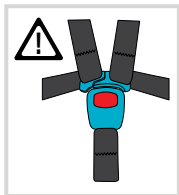



+6 M

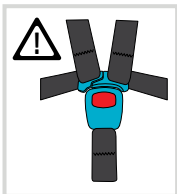



EN	Stroller + car seat	SK	Kočik + detská autosedačka
FR	Poussette + siège auto	BG	Количка + Детска седалка за кола
DE	Kinderwagen + Babyschale	UK	Коляска + автокрісло
NL	Wandelwagen + autozitje voor baby's	HU	Babakocsi + gyermek biztonsági autósülés
IT	Passerino + seggiolino auto	SL	Otroški voziček + otroški avtosedež
SV	Barnvagn + babyskydd	ET	Lapsevanker + lapse autoiste
DA	Klapvogn + babysæde	CZ	Kočárek + dětská autosedačka
FI	Rattaat + vauvan turv	EL	Καρότσι + κάθισμα αυτοκινήτου
PL	Wózek + fotelik samochodowy	RO	Cărucior + scaun automobil pentru co
NO	Vogn + bilsete for babyer	HE	סיילון + מושב
RU	Коляска + автокрес	AR	عربة الأطفال + كرسي أوتوماتيكي للرضع
TR	Puset + oto güvenli koltuğu		
HR	Kolica + auto sjedalica za bebu		



Pebble	Rock
Pebble Plus	CabrioFix
Pebble Pro	Citi

www.maxi-cosi.com



- EN For up-to-date unique compatibilities please check online – Do not use other products
- FR Pour les compatibilités uniques et à jour, veuillez vérifier en ligne – N'utilisez pas d'autres produits
- DE Konsultieren Sie unsere Website nach aktualisierten kompatiblen Artikeln – Verwenden Sie keine anderen Produkte
- NL Kijk online voor unieke up-to-date compatibiliteit – Gebruik geen andere producten
- IT Per le compatibilità esclusive aggiornate vi preghiamo di verificare online – Non utilizzare altri prodotti
- SV För aktuella, unika kompatibiliteter, se efter online – Använd inte andra produkter
- DA Tjek online for aktuelle, unikke kompatibiliteter – Anvend ikke andre produkter
- FI Katso ajantasaiset yksilölliset yhteensopivuudet verkosta – Älä käytä muita tuotteita
- PL Aby uzyskać aktualną, niepowtarzalną zgodność, należy sprawdzić w Internecie – Nie używać innych produktów
- NO For oppdaterte unike kompatibiliteter, sjekk på nettstedet – Ikke bruk andre produkter
- RU Актуальную информацию об уникальной совместимости см. онлайн – Не используйте другие продукты
- TR Güncel özel uyumluluklar için lütfen İnternet üzerinden kontrol edin – Başka ürünler kullanmayın

- HR Najnovije jedinstvene značajke kompatibilnosti potražite na mreži – Ne upotrebljavajte druge proizvode
- SK Aktuálne informácie o jedinečných kompatibilných možnostiach nájdete na webe – nepoužívajte iné produkty
- BG Проверете онлайн за актуални уникални опции за съвместимост – не използвайте други продукти
- UK Актуальну інформацію про унікальну сумісність див. онлайн – Не використовуйте інші продукти
- HU A naprakész egyedi kompatibilitási jellemzők ügyében tekintse meg az online erőforrásokat – Ne használjon egyéb termékeket
- SL Posodobljene edinstvene podatke o združljivosti preverite na spletu – ne uporabljajte drugih izdelkov
- ET Ajakohaste unikaalsete ühilduvuste kohta kontrollige online – ärge kasutage muid tooteid
- CZ Aktualizovaný seznam jedinečných kompatibilních produktů vyhledejte prosím online – Jiné výrobky nepoužívejte
- EL Για ενημερωμένα μοναδικά συμβατά προϊόντα παρακαλούμε ελέγξτε στο διαδίκτυο - Μην χρησιμοποιείτε άλλα προϊόντα
- RO Pentru compatibilități unice actualizate, verificați online – Nu utilizați alte produse
- HE לקבלת מידע מיוחד על יכולות תאימות ייחודיות, חפשו באינטרנט - אל תשתמשו במוצרים אחרים
- AR لتحديث التوافق الفريد ، يرجى التحقق عبر الإنترنت - لا تستخدم منتجات أخرى.

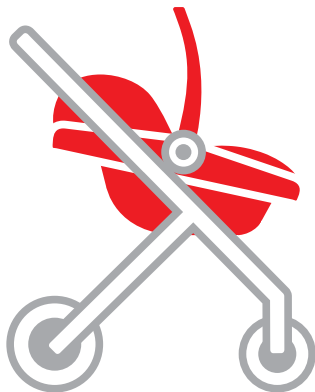



1.

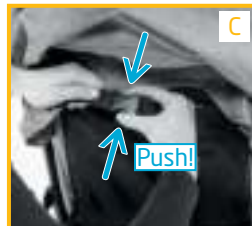





5.

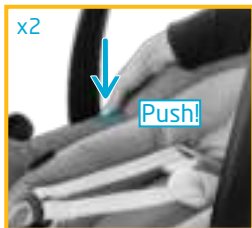

6.







EN	Washing	HR	Pranje
FR	Lavage	SK	Pranie
DE	Reinigung	BG	Почистване
NL	Reinigen	UK	Прання
IT	Lavaggio	HU	Mosás
SV	Tvättråd	SL	Pranje
DA	Vask	ET	Pesemine
FI	Pesu	CZ	Praní
PL	Czyszczenie	EL	Πλύσιμο
NO	Rengjøring	RO	Spălare
RU	Чистка	HE	הכשרה
TR	Yıkama	AR	غسل

www.maxi-cosi.com





Lara²

0 M - <48 M / Max 22 kg

DOREL FRANCE S.A.S.

Z.I. - 9 bd du Poitou
BP 905
49309 Cholet Cedex
FRANCE

DOREL BENELUX

P.O. Box 6071
5700 ET Helmond
NEDERLAND

DOREL UK Ltd.

2nd Floor, Building 4
Imperial Place
Maxwell Road
Borehamwood, Herts
WD6 1JN
UNITED KINGDOM

DOREL GERMANY GMBH

Augustinusstraße 9 c
D-50226 Frechen-Königsdorf
DEUTSCHLAND

DOREL ITALIA S.P.A.

Via Verdi, 14
24060 Telgate (BG)
ITALIA

DOREL HISPANIA S.A.U.

Edificio Barcelona Moda Centre
Ronda Maiols, 1
Planta 4ª,
Locales 401 - 403 - 405
08192 Sant Quirze del Vallès
ESPAÑA

DOREL PORTUGAL

Rua Pedro Dias, 25
4480-614 Rio Mau (VDC)
PORTUGAL

DOREL JUVENILE

SWITZERLAND S.A.
Chemin de la Colice 4
1023 Crissier
SWITZERLAND / SUISSE

DOREL POLSKA Sp. z o.o.

Innowacyjna 8
41-208 Sosnowiec
POLAND