

FOR CAR USE ONLY/NUR FÜR AUTOMOBIL GEBRAUCH/POUR APPLICATION AUTOMOBILE UNIQUEMENT/PARA USO EN AUTOMÓVILES/SOLO PER L'UTILIZZO IN AUTOMOBILE/ENDAST FÖR BILBRUK/ALLEEN VOOR GEBRUIK IN DE AUTO/ ТОЛЬКО ДЛЯ ИСПОЛЬЗОВАНИЯ В АВТОМОБИЛЯХ/DO UŻYCIA TYLKO W SAMOCHODZIE

# ALPINE®

## CD/USB RECEIVER

### CDE-182R/CDE-181R

### CDE-181RR/CDE-181RM

### CDE-180R/CDE-180RR/CDE-180RM

## DIGITAL MEDIA RECEIVER

### UTE-81R

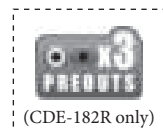

- OWNER'S MANUAL  
Please read before using this equipment.
- BEDIENUNGSANLEITUNG  
Lesen Sie diese Bedienungsanleitung bitte vor Gebrauch des Gerätes.
- MODE D'EMPLOI  
Veuillez lire avant d'utiliser cet appareil.
- MANUAL DE OPERACIÓN  
Léalo antes de utilizar este equipo.
- ISTRUZIONI PER L'USO  
Si prega di leggere prima di utilizzare il attrezzatura.
- ANVÄNDARHANDLEDNING  
Innan du använder utrustningen bör du läsa igenom denna användarhandledning.
- GEBRUIKERSHANDLEIDING  
Lees deze aanwijzingen aandachtig alvorens dit toestel te gebruiken.
- РУКОВОДСТВО ПО ЭКСПЛУАТАЦИИ  
Прочтите настоящее руководство перед началом использования оборудования.
- INSTRUKCJA OBSŁUGI  
Prosimy zapoznać się z tą instrukcją przed przystąpieniem do użytkowania urządzenia.

**ALPINE ELECTRONICS MARKETING, INC.**  
1-7, Yukigaya-Otsukamachi, Ota-ku,  
Tokyo 145-0067, JAPAN  
Phone: 03-5499-4531

**ALPINE ELECTRONICS OF AMERICA, INC.**  
19145 Gramercy Place, Torrance,  
California 90501, U.S.A.  
Phone 1-800-ALPINE-1 (1-800-257-4631)

**ALPINE ELECTRONICS OF AUSTRALIA PTY. LTD.**  
161-165 Princes Highway, Hallam  
Victoria 3803, Australia  
Phone 03-8787-1200

**ALPINE ELECTRONICS GmbH**  
Wilhelm-Wagenfeld-Str. 1-3, 80807 München, Germany  
Phone 089-32 42 640

**ALPINE ELECTRONICS OF U.K. LTD.**  
Alpine House  
Fletchamstead Highway, Coventry CV4 9TW, U.K.  
Phone 0870-33 33 763

**ALPINE ELECTRONICS FRANCE S.A.R.L.**  
(RCS PONTOISE B 338 101 280)  
98, Rue de la Belle Etoile, Z.I. Paris Nord II,  
B.P. 50016, 95945 Roissy Charles de Gaulle  
Cedex, France  
Phone 01-48638989

**ALPINE ITALIA S.p.A.**  
Viale C. Colombo 8, 20090 Trezzano  
Sul Naviglio (MI), Italy  
Phone 02-484781

**ALPINE ELECTRONICS DE ESPAÑA, S.A.**  
Portal de Gamarra 36, Pabellón, 32  
01013 Vitoria (Alava)-APDO 133, Spain  
Phone 945-283588

EN

DE

FR

ES

IT

SE

NL

RU

PL



## Operating Instructions

### WARNING

WARNING .....	5
CAUTION .....	5
PRECAUTIONS .....	5

### Getting Started

Accessory List .....	8
Turning Power On and Off .....	8
Demonstration Function .....	8
Source Selection .....	8
Detaching and Attaching the Front Panel .....	8
Detaching .....	8
Attaching .....	8
Adjusting Volume .....	9

### Radio

Listening to Radio .....	9
Presetting Stations Manually .....	9
Presetting Stations Automatically .....	10
Tuning to Preset Stations .....	10
Frequency Search Function .....	10

### RDS

Turning AF (Alternative Frequencies) ON/OFF .....	10
Receiving RDS Regional (Local) Stations .....	11
PI SEEK Setting .....	11
Receiving Traffic Information .....	11
Receiving Traffic Information While Playing	
USB Audio or Radio .....	11
Displaying Radio Text .....	11

### CD/MP3/WMA/AAC (CDE-182R/ CDE-181 Series/CDE-180 Series only)

Playback .....	12
Repeat and Random Play .....	12
Searching for CD Text (concerning Audio CD) .....	12
Folder/File Name Search (concerning MP3/WMA/AAC) .....	13
Folder Name Search mode .....	13
File Name Search mode .....	13
Search Position Memory .....	13
About MP3/WMA/AAC .....	13
Terminology .....	14

### Sound Setting

Adjusting Subwoofer Level/Bass Level/ Mid Level/Treble Level/Balance (Between Left and Right)/Fader (Between Front and Rear)/ Loudness/Defeat .....	15
Audio Setup .....	15
Equalizer Presets .....	16
Setting BASS ENGINE SQ ON/OFF .....	16
Turning Loudness On/Off .....	16
Adjusting the Parametric Equalizer Curve (3BAND EQ) .....	16
Setting the Control .....	16
Setting the Source Volume Level .....	16
Turning Subwoofer ON/OFF .....	16
Adjusting the Low Pass Filter .....	17
Setting the Subwoofer Phase .....	17
Setting the Subwoofer System .....	17
External Device .....	17
Connecting to an External Amplifier (POWER IC) .....	17

### BASS ENGINE SQ Function

Setting BASS ENGINE SQ ON/OFF .....	18
Adjusting BASS ENGINE SQ Level .....	18

### Other Functions

Displaying the Text .....	19
About "Text" .....	19
Using the Front AUX Input Terminal .....	19
Option Menu Setting .....	20

### SETUP

Setting .....	20
General Setting .....	21
Setting the Menu Language .....	21
Setting the AUX SETUP mode .....	21
Setting the AUX NAME mode .....	21
Playing MP3/WMA/AAC Data (PLAY MODE) (CDE-182R/CDE-181 Series/CDE-180 Series only) .....	21
Setting the Demonstration mode .....	21
Display Setting .....	21
Dimmer Control .....	21
Scroll Setting (TEXTSCROLL) .....	21
iPod/iPhone Setting .....	22
iPod/iPhone Search Mode Setting .....	22

### USB Memory (optional)

Playing MP3/WMA/AAC Files from USB Memory (optional) .....	22
About MP3/WMA/AAC File of USB Memory ...	22

## **iPod/iPhone (optional) (CDE-182R/CDE-181 Series only)**

Connecting an iPod/iPhone .....	23
Setting the iPod Control .....	23
Playback .....	23
Searching for a desired Song .....	24
Alphabet search function .....	24
Direct Search Function.....	25
Select Playlist/Artist/Album/Genre/ Composer .....	25
Random Play Shuffle (M.I.X.) .....	25
Repeat Play .....	25

## **Information**

In Case of Difficulty.....	26
Basic .....	26
Radio.....	26
CD (CDE-182R/CDE-181 Series/ CDE-180 Series only).....	26
MP3/WMA/AAC .....	26
Audio .....	26
iPod (CDE-182R/CDE-181 Series only).....	26
Indication for CD Player (CDE-182R/ CDE-181 Series/CDE-180 Series only).....	27
Indication for USB Memory .....	27
Indication for iPod Mode (CDE-182R/CDE-181 Series only).....	27
Specifications .....	29

---

## **Installation and Connections**

<b>WARNING</b> .....	<b>30</b>
<b>CAUTION</b> .....	<b>30</b>
<b>PRECAUTIONS</b> .....	<b>30</b>
Installation.....	31
Removal.....	31
Connections.....	33

### **Notes**

- The description related with Disc on this Owner's Manual is only applicable to CDE-182R/CDE-181 Series/CDE-180 Series.
- The illustrations on this Owner's Manual use CDE-182R as an example.

# Operating Instructions

## WARNING

### WARNING

This symbol means important instructions. Failure to heed them can result in serious injury or death.

#### **DO NOT OPERATE ANY FUNCTION THAT TAKES YOUR ATTENTION AWAY FROM SAFELY DRIVING YOUR VEHICLE.**

Any function that requires your prolonged attention should only be performed after coming to a complete stop. Always stop the vehicle in a safe location before performing these functions. Failure to do so may result in an accident.

#### **KEEP THE VOLUME AT A LEVEL WHERE YOU CAN STILL HEAR OUTSIDE NOISES WHILE DRIVING.**

Excessive volume levels that obscure sounds such as emergency vehicle sirens or road warning signals (train crossings, etc.) can be dangerous and may result in an accident. LISTENING AT LOUD VOLUME LEVELS IN A CAR MAY ALSO CAUSE HEARING DAMAGE.

#### **DO NOT DISASSEMBLE OR ALTER.**

Doing so may result in an accident, fire or electric shock.

#### **USE ONLY IN CARS WITH A 12 VOLT NEGATIVE GROUND.**

(Check with your dealer if you are not sure.) Failure to do so may result in fire, etc.

#### **KEEP SMALL OBJECTS SUCH AS BATTERIES OUT OF THE REACH OF CHILDREN.**

Swallowing them may result in serious injury. If swallowed, consult a physician immediately.

#### **USE THE CORRECT AMPERE RATING WHEN REPLACING FUSES.**

Failure to do so may result in fire or electric shock.

#### **DO NOT BLOCK VENTS OR RADIATOR PANELS.**

Doing so may cause heat to build up inside and may result in fire.

#### **USE THIS PRODUCT FOR MOBILE 12V APPLICATIONS.**

Use for other than its designed application may result in fire, electric shock or other injury.

#### **DO NOT PLACE HANDS, FINGERS OR FOREIGN OBJECTS IN INSERTION SLOTS OR GAPS.**

Doing so may result in personal injury or damage to the product.

### CAUTION

This symbol means important instructions. Failure to heed them can result in injury or material property damage.

#### **HALT USE IMMEDIATELY IF A PROBLEM APPEARS.**

Failure to do so may cause personal injury or damage to the product. Return it to your authorized Alpine dealer or the nearest Alpine Service Centre for repairing.

### PRECAUTIONS

#### **Product Cleaning**

Use a soft dry cloth for periodic cleaning of the product. For more severe stains, please dampen the cloth with water only. Anything else has the chance of dissolving the paint or damaging the plastic.

#### **Temperature**

Be sure the temperature inside the vehicle is between +60°C (+140°F) and -10°C (+14°F) before turning your unit on.

#### **Moisture Condensation**

You may notice the CD playback sound wavering due to condensation. If this happens, remove the disc from the player and wait about an hour for the moisture to evaporate.

#### **Damaged Disc**

Do not attempt to play cracked, warped, or damaged discs. Playing a bad disc could severely damage the playback mechanism.

#### **Maintenance**

If you have problems, do not attempt to repair the unit yourself. Return it to your Alpine dealer or the nearest Alpine Service Station for servicing.

#### **Never Attempt the Following**

Do not grip or pull out the disc while it is being pulled back into the player by the automatic reloading mechanism.

Do not attempt to insert a disc into the unit when the unit power is off.

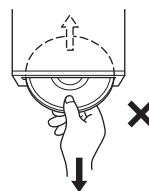

#### **Inserting Discs**

Your player accepts only one disc at a time for playback. Do not attempt to load more than one disc.

Make sure the label side is facing up when you insert the disc. "ERROR" will be displayed on your player if you insert a disc incorrectly.

Playing a disc while driving on a very bumpy road may result in skips, but this will not scratch the disc or damage the player.

---

## New Discs

To prevent the CD from jamming, "ERROR" is displayed if discs with irregular surfaces are inserted or if discs are inserted incorrectly. When a new disc is ejected immediately after initial loading, use your finger to feel around the inside of the centre hole and outside edge of the disc. If you feel any small bumps or irregularities, this could inhibit proper loading of the disc. To remove the bumps, rub the inside edge of the hole and outside edge of the disc with a ballpoint pen or other such instrument, and then insert the disc again.

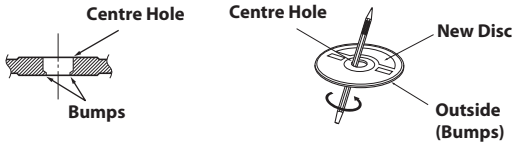

---

## Irregular Shaped Discs

Be sure to use round discs only for this unit and never use any special shaped discs. Use of special shape discs may cause damage to the mechanism.



---

## Installation Location

Make sure this unit will not be installed in a location subjected to:

- Direct sun and heat
- High humidity and water
- Excessive dust
- Excessive vibrations

---

## Correct Handling

Do not drop the disc while handling. Hold the disc so you will not leave fingerprints on the surface. Do not affix tape, paper, or gummed labels to the disc. Do not write on the disc.

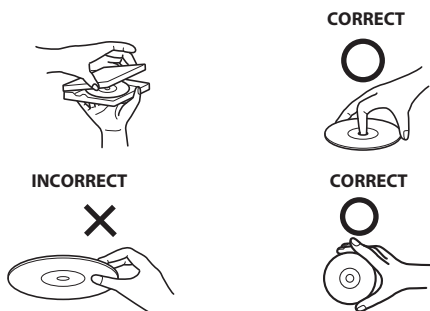

---

## Disc Cleaning

Fingerprints, dust, or soil on the surface of the disc could cause the CD player to skip. For routine cleaning, wipe the playing surface with a clean, soft cloth from the centre of the disc to the outer edge. If the surface is heavily soiled, dampen a clean, soft cloth in a solution of mild neutral detergent before cleaning the disc.



---

## Disc Accessories

There are various accessories available on the market for protecting the disc surface and improving sound quality. However, most of them will influence the thickness and/or diameter of the disc. Using such accessories can cause the disc to be out of standard specifications and may create operational problems. We recommend not using these accessories on discs played in Alpine CD players.

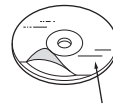

Transparent Sheet

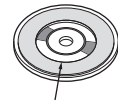

Disc Stabilizer

---

## On handling Compact Discs (CD/CD-R/CD-RW)

- Do not touch the surface.
- Do not expose the disc to direct sunlight.
- Do not affix stickers or labels.
- Clean the disc when it is dusty.
- Make sure that there are no bumps around the disc.
- Do not use commercially available disc accessories.

**Do not leave the disc in the car or the unit for a long time. Never expose the disc to direct sunlight.** Heat and humidity may damage the CD and you may not be able to play it again.

### To customers using CD-R/CD-RW

- If a CD-R/CD-RW cannot be played back, make sure the last recording session was closed (finalised).
- Finalise the CD-R/CD-RW if necessary, and attempt playback again.

---

## About media that can be played

Use only compact discs with the label side showing the CD logo marks below.



If you use unspecified compact discs, correct performance cannot be guaranteed.

You can play CD-Rs (CD-Recordables)/CD-RWs (CD-ReWritables) which have been recorded only on audio devices. You can also play CD-Rs/CD-RWs containing MP3/WMA/AAC formatted audio files.

- Some of the following CDs may not play on this unit:  
Flawed CDs, CDs with fingerprints, CDs exposed to extreme temperatures or sunlight (e.g., left in the car or this unit), CDs recorded under unstable conditions, CDs on which a recording failed or a re-recording was attempted, copy-protected CDs which do not conform to the audio CD industry standard.

- Use discs with compressed audio files written in a format compatible with this unit. For details, refer to “About MP3/WMA/AAC” on page 13.
- ROM data other than audio files contained in a disc will not produce sound when played back.

---

### Protecting the USB Port

- Only USB Flash Memory devices and iPod/iPhone can be connected to the USB port on this unit. Correct performance using other USB products cannot be guaranteed. A USB hub is not supported.
- Depending on the shape or size of a USB memory device, it may not be connected to the USB terminal of this unit—a USB extension (sold separately) is recommended for this connection.  
Also, avoid connecting USB memory and Front Aux at the same time.
- If a USB device is inserted in the unit, it projects out and may be a danger while driving.  
Use a commercially available USB extension cable, and connect it in a safe way.
- Depending on the connected USB Memory device, the unit may not function or some functions may not be performed.
- The audio file format that can be played back on the unit is MP3/WMA/AAC.
- Artist/song name, etc., can be displayed, however some characters may not be correctly displayed.

---

### On Handling USB Memory

#### CAUTION

**Alpine accepts no responsibility for lost data, etc., even if data, etc., is lost while using this product.**

- To prevent malfunction or damage, note the following points.  
Read the USB Memory Owner's Manual thoroughly.  
Do not touch the terminals by hand or metal.  
Do not subject USB Memory to excessive shock.  
Do not bend, drop, disassemble, modify or soak in the water.
- Fix the USB Memory in a location where driver operation will not be hindered.
- USB Memory may not function correctly at high or low temperature.
- Use only certified USB Memory. Please pay attention that even certified USB Memory, may not function correctly depending on its type or state.
- USB Memory function is not guaranteed. Use USB Memory according to the terms of agreement.
- Depending on the settings of the USB Memory type, memory state or encoding software, the unit may not play back or display properly.
- A file that is copy-protected (copyright protection) cannot be played back.
- USB Memory may take time to start playback. If there is a particular file other than audio in the USB Memory, it may take considerable time before the file is played back or searched.
- The unit can play back “mp3”, “wma” or “m4a” file extensions.
- Do not add the above extensions to a file other than audio data. This non-audio data will not be recognised. The resulting playback may contain noise that can damage speakers and/or amplifiers.
- It is recommended to back up important data on a personal computer.
- Do not remove the USB device while playback is in progress. Change SOURCE to something other than USB, and then remove the USB device to prevent possible damage to its memory.

# Getting Started

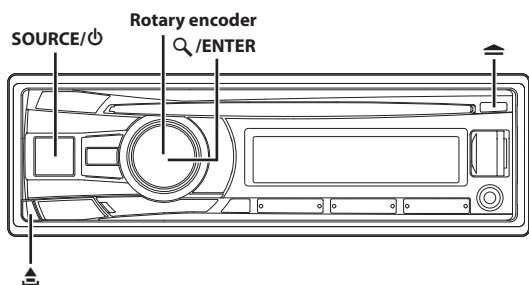

## Accessory List

- Head Unit .....1
- Power Cable .....1
- Mounting Sleeve .....1
- Carrying Case  
(CDE-182R/CDE-181 Series/CDE-180 Series only) .....1
- Bracket Key .....2
- Rubber Cap .....1
- Hex Bolt .....1
- Screw (M5 × 8) .....4
- Owner's Manual ..... 1 set

## Turning Power On and Off

Press **SOURCE/⏻** to turn on the unit.

### Note

- The unit can be turned on by pressing any other button except **▲** and **⏻** (Release).

Press and hold **SOURCE/⏻** for at least 2 seconds to turn off the unit.

### Note

- The first time power is turned on, the volume will start from level 12.

## Demonstration Function

This unit has a demonstration feature for display. When Demo mode is set to ON (initial setting), the unit starts the demonstration if there is no operation for 30 seconds.

When installing this unit in a car for the first time, the DEMO OFF screen will be displayed for 30 seconds after turning on the unit.

Press **Q/ENTER** within 30 seconds to turn off the Demonstration mode\*.

Otherwise, the Demo mode remains ON and the unit starts the demonstration if there is no operation for 30 seconds.

- \* The operation is the same as setting DEMO MODE to OFF in the Setup menu. However, if the unit is disconnected from the vehicle's battery, DEMO MODE will be switched to ON automatically when the unit is used next time. If you want to completely close the Demo mode, set DEMO MODE to QUIT OFF. For details, please refer to "Setting the Demonstration mode" on page 21.

## Source Selection

Press **SOURCE/⏻** to change the source.

TUNER → DISC\*1 → USB AUDIO/iPod\*2 → AUXILIARY\*3 → TUNER

\*1 Only for CDE-182R/CDE-181 Series/CDE-180 Series.

\*2 Only for CDE-182R/CDE-181 Series and when the iPod/iPhone is connected.

\*3 Only when AUX SETUP is set to ON. Refer to "Setting the AUX SETUP mode" on page 21.

## Detaching and Attaching the Front Panel

### Detaching

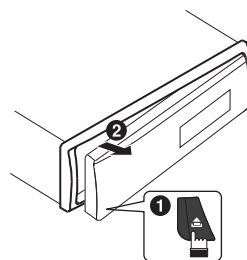

### Notes

- The front panel may become hot in normal usage (especially the connector terminals on the back of the front panel). This is not a malfunction.
- To protect the front panel, place it in the supplied carrying case (CDE-182R/CDE-181 Series/CDE-180 Series only).
- When detaching the front panel, do not apply excessive force as it may result in malfunction.

### Attaching

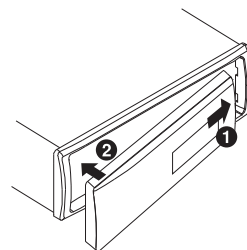

### Notes

- Before attaching the front panel, make sure that there is no dirt or dust on the connector terminals and no foreign object between the front panel and the main unit.
- Attach the front panel carefully, holding the sides of the front panel to avoid pushing buttons by mistake.



## Adjusting Volume

Turn the **Rotary encoder** until the desired sound is obtained.

### Controllable with Remote Control (CDE-182R/CDE-181 Series/CDE-180 Series only)

This unit can be controlled with an optional Alpine remote control. For details, consult your Alpine dealer. Point the optional remote control transmitter at the remote-control sensor.

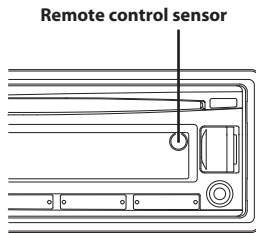

### Connectable to Remote Control Interface Box (CDE-182R/CDE-181 Series/CDE-180 Series only)

With an optional Alpine Steering Wheel Remote Control Interface Box (not included), this unit is controllable from the vehicle's steering wheel controls. For details, contact your Alpine dealer.

## Radio

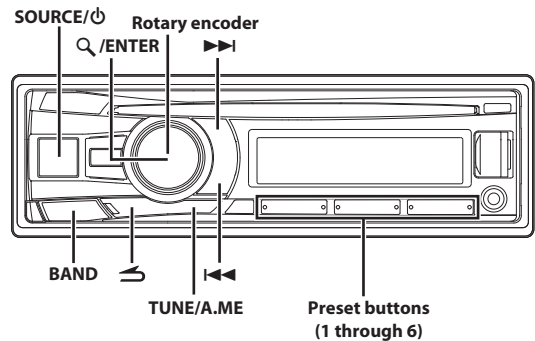

## Listening to Radio

- 1 Press **SOURCE/⏻** to select TUNER mode.
- 2 Press **BAND** repeatedly until the desired radio band is displayed.  
F1 (FM1) → F2 (FM2) → F3 (FM3) → MW → LW → F1 (FM1)
- 3 Press **TUNE/A.ME** to select the tuning mode.  
SEEK DX (Distance mode) → SEEK LOCAL (Local mode) → MANUAL (Manual mode) → SEEK DX  
**Distance mode (Initial setting):**  
Both strong and weak stations will be automatically tuned in (Automatic Seek Tuning). The "DX" indicator lights up.  
**Local mode:**  
Only strong stations will be automatically tuned in (Automatic Seek Tuning).  
**Manual mode:**  
The frequency is manually tuned in steps (Manual tuning).
- 4 Press **◀◀** or **▶▶** to tune in the desired station.  
In Manual mode, holding down **◀◀** or **▶▶** will change the frequency continuously.

## Presetting Stations Manually

- 1 Select the radio band and tune in a desired radio station you wish to store in the preset memory.
- 2 Press and hold for at least 2 seconds, any one of the **preset buttons (1 through 6)** into which you wish to store the station.  
The selected station is stored.  
The display shows the band, preset number and station frequency memorized.

### Notes

- A total of 30 stations can be stored in the preset memory (6 stations for each band; FM1, FM2, FM3, MW and LW).
- If you store a station in a preset memory which already has a station, the current station will be cleared and replaced with the new station.

## Presetting Stations Automatically

- 1 Press **BAND** repeatedly until the desired radio band is displayed.
- 2 Press and hold **TUNE/A.ME** for at least 2 seconds.  
The frequency on the display continues to change while the automatic memory is in progress. The tuner will automatically seek and store 6 strong stations in the selected band. They will be stored into preset buttons 1 to 6 in order of signal strength. When the automatic memory has been completed, the tuner goes to the station stored in preset location No.1.

### Note

- If no stations are stored, the tuner will return to the original station you were listening to before the auto memory procedure began.

## Tuning to Preset Stations

- 1 Press **BAND** repeatedly until the desired band is displayed.
- 2 Press any one of the station preset buttons (1 through 6) that has your desired radio station in memory.  
The display shows the band, preset number and frequency of the station selected.

## Frequency Search Function

You can search for a radio station by its frequency.

- 1 Press **Q/ENTER** in Radio mode to activate Frequency search mode.  
The "Q" indicator lights up.
- 2 Turn the **Rotary encoder** to select the desired frequency.
- 3 Press **Q/ENTER** to receive the selected frequency.

### Note

- Press **↵** in the search mode to cancel. Or, the search mode will be cancelled if no operation is performed for 10 seconds.

## RDS

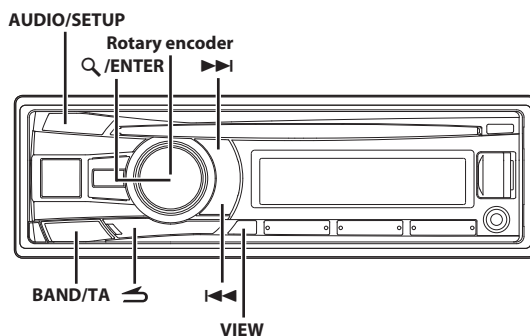

## Turning AF (Alternative Frequencies) ON/OFF

The RDS (Radio Data System) is a radio information system using the 57 kHz subcarrier of regular FM broadcast. The RDS allows you to receive a variety of information such as traffic information, station names, and to automatically re-tune to a stronger transmitter that is broadcasting the same programme.

- 1 Press and hold **AUDIO/SETUP** for at least 2 seconds to activate the **SETUP** selection mode.
- 2 Turn the **Rotary encoder** to select the "TUNER" setup mode, and then press **Q/ENTER**.
- 3 Turn the **Rotary encoder** to select the "AF", and then press **Q/ENTER**.
- 4 Turn the **Rotary encoder** to select the AF (Alternative Frequency) ON or OFF mode.
- 5 Press and hold **AUDIO/SETUP** for at least 2 seconds to return to normal mode.

### Notes

- When the AF ON mode is selected, the unit automatically tunes to a strong signal station in the AF list.
- Use the AF OFF mode when automatic re-tuning is not required.
- Press **↵** to return to the previous mode.
- Pressing and holding **↵** for at least 2 seconds will return to normal mode.
- If no operation is performed for 60 seconds, the unit will return to normal mode automatically.

The RDS digital data includes the following:

PI	Programme Identification
PS	Programme Service Name
AF	List of Alternative Frequencies
TP	Traffic Programme
TA	Traffic Announcement
PTY	Programme Type
EON	Enhanced Other Networks

---

## Receiving RDS Regional (Local) Stations

---

- 1 Press and hold **AUDIO/SETUP** for at least 2 seconds to activate the **SETUP** selection mode.
- 2 Turn the **Rotary encoder** to select the “**TUNER**” setup mode, and then press **Q/ENTER**.
- 3 Turn the **Rotary encoder** to select the “**REGIONAL**”, and then press **Q/ENTER**.
- 4 Turn the **Rotary encoder** to select “**REG ON**” or “**REG OFF**”.  
In the **OFF** mode, the unit automatically keeps receiving the related local RDS station.
- 5 Press and hold **AUDIO/SETUP** for at least 2 seconds to return to normal mode.

### Notes

- Press **↵** to return to the previous mode.
- Pressing and holding **↵** for at least 2 seconds will return to normal mode.
- If no operation is performed for 60 seconds, the unit will return to normal mode automatically.

---

## PI SEEK Setting

---

- 1 Press and hold **AUDIO/SETUP** for at least 2 seconds to activate the **SETUP** mode.
- 2 Turn the **Rotary encoder** to select the “**TUNER**” setup mode, and then press **Q/ENTER**.
- 3 Turn the **Rotary encoder** to select “**PI SEEK**”, and then press **Q/ENTER**.
- 4 Turn the **Rotary encoder** to select “**PISEEK ON**” or “**PISEEK OFF**”.
- 5 Press and hold **AUDIO/SETUP** for at least 2 seconds to return to normal mode.

### Notes

- Press **↵** to return to the previous mode.
- Pressing and holding **↵** for at least 2 seconds will return to normal mode.
- If no operation is performed for 60 seconds, the unit will return to normal mode automatically.

---

## Receiving Traffic Information

---

- 1 Press and hold **BAND/TA** for at least 2 seconds so that the “**TA**” indicator lights up.
- 2 Press **◀▶** or **▶▶** to select your desired traffic information station.

When a traffic information station is tuned in, the “**TP**” indicator lights up.

Traffic information is heard only when it is being broadcast. If traffic information is not being broadcast, the unit is set in the standby mode. When a traffic information broadcast begins, the unit automatically receives it and the display shows “**TRF-INFO**” for 2 seconds.

When the traffic information broadcast is over, the unit will automatically set in the standby mode.

### Notes

- If you do not want to listen to the traffic information being received, lightly press **BAND/TA** to skip that traffic information message. The **TA** mode will remain in the **ON** position to receive the next traffic information message.
- If the volume level is changed while receiving traffic information, the changed volume level will be memorized. When traffic information is received next time, the volume level will be automatically adjusted to the level memorized.
- In the **TA** mode, the **SEEK** tuning selects only the **TP** stations.

---

## Receiving Traffic Information While Playing USB Audio or Radio

---

- 1 Press and hold **BAND/TA** for at least 2 seconds so that the “**TA**” indicator lights up.
- 2 Press **◀▶** or **▶▶** to select a traffic information flag if necessary.

When a traffic information broadcast starts, the unit automatically mutes the audio source (such as regular FM broadcast, **USB AUDIO**, etc.).

When the traffic information broadcast finishes, the unit automatically returns to the original source play before the traffic information broadcast began.

*When traffic information stations cannot be received:*

### In the tuner mode:

When the **TP** signal can no longer be received for over 1 minute, the “**TA**” indicator blinks.

### In other audio source mode:

When the **TP** signal can no longer be received, the traffic information station of another frequency will be selected automatically.

### Note

- The receiver is equipped with the **EON** (Enhanced Other Networks) function in order to keep track of additional alternate frequencies to the **AF** list. If the station being received does not broadcast the traffic information, the receiver automatically tunes in the related station that broadcasts the traffic information when it occurs.

- 3 Press and hold **BAND/TA** for at least 2 seconds to deactivate the **Traffic Information** mode.

The “**TA**” indicator goes out.

---

## Displaying Radio Text

---

Text messages from a radio station can be displayed.

Press **VIEW** while receiving **FM** in the radio mode to select the **Radio Text** display.

The display will change every time the button is pressed. For details, refer to “**Displaying the Text**” on page 19.

# CD/MP3/WMA/AAC (CDE-182R/CDE-181 Series/ CDE-180 Series only)

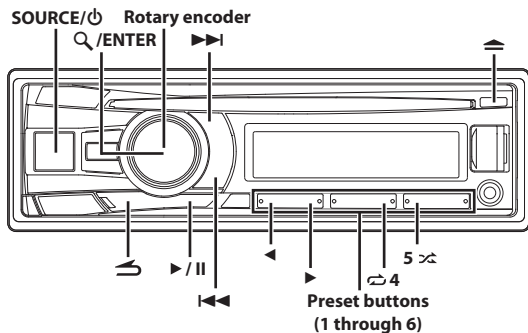

## Playback

- 1 Insert a disc with the label side facing up.  
The disc will be pulled into the unit automatically.

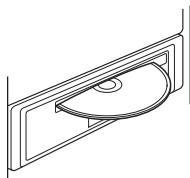

### Note

- When a disc is already inserted, press **SOURCE/ϕ** to switch to the DISC mode.

- 2 While playing back MP3/WMA/AAC, press ◀ or ▶ to select the desired folder.  
Pressing and holding ◀ or ▶ will change folders continuously.
- 3 Press ◀◀ or ▶▶ to select the desired track (file).  
Pressing and holding ◀◀ or ▶▶ will fast backward/fast forward track continuously.
- 4 To pause playback, press ▶/||.  
Pressing ▶/|| again will resume playback.
- 5 To eject the disc, press ▲.

### Notes

- Do not remove a CD during its eject cycle. Do not load more than one disc at a time. A malfunction may result from doing either.
- The "Q" indicator lights up when a disc is inserted.
- Three-inch (8 cm) CDs cannot be used.
- Any file protected by DRM (Digital Rights Management) copy protection, cannot be played back on this unit.
- The track display for MP3/WMA/AAC data playback is the file numbers recorded on the disc.
- The playback time may not be correctly displayed when a VBR (Variable Bit Rate) recorded file is played back.

- During CD/MP3/WMA/AAC playback, press ↵, and then you can quickly return to the hierarchy level selected last time in the search mode.

## Repeat and Random Play

- 1 During playback, Press ↺ 4 or 5 ↻ repeatedly until the setting appears.
  - RPT ONE ↺:**  
Track/file is played back repeatedly.
  - RPT FOLDER ↺📁\*:**  
Files in a folder are played back repeatedly.
  - MIX FOLDER 📁↻\*:**  
Files in a folder are played back randomly.
  - MIX ALL ALL ↻:**  
All files in the disc or USB Memory are played back randomly.
  - \* When MP3/WMA/AAC files are played back.
- 2 To cancel repeat or M.I.X. play, select (off) with the above procedure.

## Searching for CD Text (concerning Audio CD)

On discs utilizing CD Text, songs can be searched and played by using their recorded titles. For discs without CD Text, searches are made using the track numbers associated with each song.

- 1 Press Q/ENTER during play.  
This will set the search mode, and the "Q" indicator lights up.
- 2 Turn the Rotary encoder to select the desired track, and then press Q/ENTER.  
This will play the selected track.

### Notes

- Press ↵ in the search mode to cancel. Or, the search mode is cancelled if no operation is performed for 10 seconds.
- When CD Text Search is made during M.I.X. play, the M.I.X. play mode will be cancelled.
- Press any of the **preset buttons (1 through 6)** during a search to skip over a calculated percentage of tracks. For details, refer to "Direct Search Function" on page 25.

---

## Folder/File Name Search (concerning MP3/WMA/AAC)

---

Folder and file names may be searched and displayed during playback.

### Folder Name Search mode

- 1 During MP3/WMA/AAC playback, press **Q** / **ENTER** to activate the search mode.  
The “Q” indicator lights up.
- 2 Turn the **Rotary encoder** to select Folder Name Search mode, and then press **Q** / **ENTER**.
- 3 Turn the **Rotary encoder** to select the desired folder.
- 4 Press and hold **Q** / **ENTER** for at least 2 seconds to play back the first file in the selected folder.

#### Notes

- Press any of the **preset buttons (1 through 6)** during a Folder Name search to skip over a calculated percentage of folders. For details, refer to “Direct Search Function” on page 25.
- Press and hold **↵** for at least 2 seconds in the search mode to cancel. Or, the search mode is cancelled if no operation is performed for 10 seconds.
- To search for files in the Folder Name Search mode, press **Q** / **ENTER**. Files in the folder may be searched.
- Press **↵** to exit Folder Name Search mode in step 3 in order to select File Name Search mode.
- The root folder is displayed as “ROOT”.
- When Folder Name Search is made during M.I.X. play, the M.I.X. play mode will be cancelled.

### File Name Search mode

- 1 During MP3/WMA/AAC playback, press **Q** / **ENTER** to activate the search mode.  
The “Q” indicator lights up.
- 2 Turn the **Rotary encoder** to select File Name Search mode, and then press **Q** / **ENTER**.
- 3 Select the desired file by turning the **Rotary encoder**.
- 4 Press **Q** / **ENTER** to play back the selected file.

#### Notes

- Press any of the **preset buttons (1 through 6)** during a File Name search to skip over a calculated percentage of files. For details, refer to “Direct Search Function” on page 25.
- Press and hold **↵** for at least 2 seconds in the search mode to cancel. Or, the search mode is cancelled if no operation is performed for 10 seconds.
- Press **↵** in the search mode to return to the previous mode.
- When File Name Search is made during M.I.X. play, the M.I.X. play mode will be cancelled.

---

## Search Position Memory

---

During playback, you can quickly return to the last-selected hierarchy level in the search mode.

Press **↵**.

The hierarchy you selected last in the search mode is displayed.

---

## About MP3/WMA/AAC

---

### CAUTION

**Except for private use, duplicating audio data (including MP3/WMA/AAC data) or distributing, transferring, or copying it, whether for free or for a fee, without permission of the copyright holder is strictly prohibited by the Copyright Act and by international treaty.**

#### What is MP3?

MP3, whose official name is “MPEG Audio Layer 3,” is a compression standard prescribed by the ISO, the International Standardisation Organisation and MPEG which is a joint activity institution of the IEC. MP3 files contain compressed audio data. MP3 encoding is capable of compressing audio data at extremely high ratios, reducing the size of music files to as much as one-tenth their original size. This is achieved while still maintaining near CD quality. The MP3 format realises such high compression ratios by eliminating the sounds that are either inaudible to the human ear or masked by other sounds.

#### What is WMA?

WMA, or “Windows Media™ Audio,” is compressed audio data. WMA is similar to MP3 audio data.

#### What is AAC?

AAC is the abbreviation for “Advanced Audio Coding,” and is a basic format of audio compression used by MPEG2 or MPEG4.

#### Method for creating MP3/WMA/AAC files

Audio data is compressed using software with MP3/WMA/AAC codecs. For details on creating MP3/WMA/AAC files, refer to the user’s manual for that software.

MP3/WMA/AAC files that are playable on this device have the file extensions “mp3” / “wma” / “m4a”. Files with no extension cannot be played back (WMA ver. 7.1, 8 and 9 are supported). Protected files are not supported, neither are raw AAC files (using the “.aac” extension). There are many different versions of the AAC format. Confirm that the software being used conforms to the acceptable formats listed above. It’s possible that the format may be unplayable even though the extension is valid.

Playback of AAC files encoded by iTunes is supported.

#### Supported playback sampling rates and bit rates

##### MP3

Sampling rates: 48 kHz, 44.1 kHz, 32 kHz, 24 kHz, 22.05 kHz, 16 kHz, 12 kHz, 11.025 kHz, 8 kHz

Bit rates: 8 - 320 kbps

##### WMA

Sampling rates: 48 kHz, 44.1 kHz, 32 kHz

Bit rates: 32 - 192 kbps

##### AAC

Sampling rates: 48 kHz, 44.1 kHz, 32 kHz, 24 kHz, 22.05 kHz, 16 kHz, 12 kHz, 11.025 kHz, 8 kHz

Bit rates: 16 - 320 kbps

This device may not play back correctly depending on sampling rates.

### ID3 tags/WMA tags

This device supports ID3 tag v1 and v2, and WMA tag. If tag data is in an MP3/WMA/AAC file, this device can display the title (track title), artist name, and album name ID3 tag/WMA tag data. This device can only display single-byte alphanumeric characters (up to 30 for ID3 tags and up to 15 for WMA tags) and the underscore. For non-supported characters, "NO SUPPORT" is displayed. If information contains characters other than ID3 tag information, the audio file may not be played back. The tag information may not be correctly displayed, depending on the contents.

### Playing back MP3/WMA/AAC

MP3/WMA/AAC files are prepared, then written to a CD-R, CD-RW using CD-R writing software or stored to a USB Memory. A disc can hold up to 509 files/folders (including Root Folders), and the maximum number of folders is 255. Playback may not be performed if a disc exceeds the limitations described above. Do not make a file's playback time more than 1 hour.

### Media supported

The media that this device can play back are CD-ROMs, CD-Rs, and CD-RWs.

### Corresponding File Systems

This device supports discs formatted with ISO9660 Level 1 or Level 2. Under the ISO9660 standard, there are some restrictions to remember. The maximum nested folder depth is 8 (including the root directory). The number of characters for a folder/file name is limited. Valid characters for folder/file names are letters A-Z (all caps), numbers 0-9, and '\_' (underscore). This device also can play back discs in Joliet, Romeo, etc., and other standards that conform to ISO9660. However, sometimes the file names, folder names, etc., are not displayed correctly.

### Formats supported

This device supports CD-ROM XA, Mixed Mode CD, Enhanced CD (CD-Extra) and Multi-Session. This device cannot correctly play back discs recorded with Track At Once or packet writing.

### Order of files

Files are played back in the order that the writing software writes them to the disc. Therefore, the playback order may not be what is expected. Verify the writing order in the software's documentation. The playback order of the folders and files is as follows.

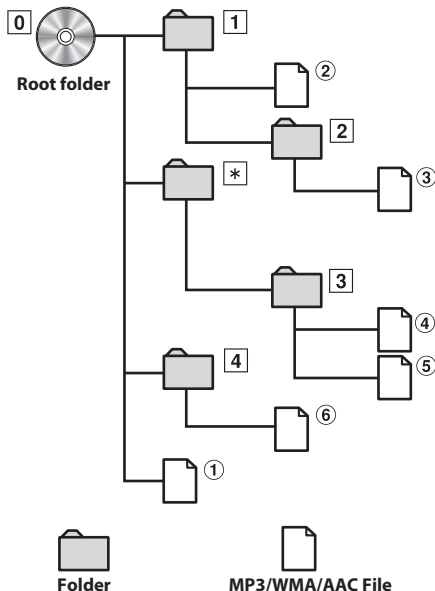

\* The folder No./ folder Name will not be displayed if no readable file is contained in the folder.

## Terminology

### Bit rate

This is the "sound" compression rate specified for encoding. The higher the bit rate, the higher the sound quality, but also the larger the files.

### Sampling rate

This value shows how many times per second the data is sampled (recorded). For example, music CDs use a sampling rate of 44.1 kHz, so the sound is sampled (recorded) 44,100 times per second. The higher the sampling rate, the higher the sound quality, but also the larger the volume of data.

### Encoding

Converting music CDs, WAVE (AIFF) files, and other sound files into the specified audio compression format.

### Tag

Song information such as track titles, artist names, album names, etc., written into MP3/WMA/AAC files.

### Root folder

The root folder (or root directory) is found at the top of the file system. The root folder contains all folders and files. It is created automatically for all burned discs.

# Sound Setting

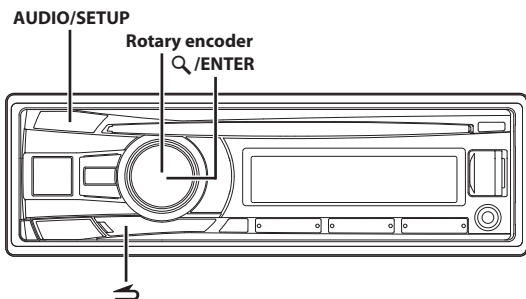

## Adjusting Subwoofer Level/Bass Level/Mid Level/Treble Level/Balance (Between Left and Right)/Fader (Between Front and Rear)/Loudness/Defeat

- 1 Press **AUDIO/SETUP** repeatedly to choose the desired mode.

Each press changes the mode as follows:

SUBWOOFER<sup>\*1/\*3</sup> → BASS LEVEL<sup>\*2/\*3</sup> → MID LEVEL<sup>\*2/\*3</sup> →  
TRE LEVEL<sup>\*2/\*3</sup> → BALANCE → FADER → LOUDNESS<sup>\*2/\*3</sup> →  
DEFEAT → VOLUME → SUBWOOFER

- \*1 Only for CDE-182R/CDE-181 Series/CDE-180 Series. When the SUBWOOFER mode is set to OFF, its level cannot be adjusted.
- \*2 Adjustable only when DEFEAT is OFF.
- \*3 Not displayed when BASS ENGINE SQ mode is on. (Page 16)

Subwoofer	+0 ~ +15
Bass level	-7 ~ +7
Mid level	-7 ~ +7
Treble level	-7 ~ +7
Balance	L15 ~ R15
Fader	R15 ~ F15
Loudness	ON/OFF
Defeat	ON/OFF
Volume	0 ~ 35

### Note

- If no operation is performed for 5 seconds, the unit automatically returns to normal mode.

- 2 Turn the **Rotary encoder** until the desired sound is obtained in each mode.

By setting DEFEAT ON, previously adjusted settings of BASS, MID, TRE LEVEL and LOUDNESS will return to the factory defaults.

## Audio Setup

You can flexibly customize the unit to suit your own preference and usage. From the AUDIO SETUP menu, Audio Setting can be modified.

**Use steps 1 to 5 to select one of the setting modes to modify. See the applicable section below for details about the selected setting item.**

- 1 Press and hold **AUDIO/SETUP** for at least 2 seconds to activate the **SETUP** mode.
- 2 Turn the **Rotary encoder** to select **AUDIO**, and then press **Q/ENTER**.

### Note

- When BASS ENGINE SQ setting is set to OFF (MANUAL SET) (page 16), you can also activate the Audio Setup mode directly by pressing **BASS**.

- 3 Turn the **Rotary encoder** to select the desired sound setting menu, and then press **Q/ENTER**.

EQ PRESETS<sup>c\*1/\*3/\*4</sup> ↔ BASS ENGIN<sup>\*2</sup> ↔ LOUDNESS<sup>\*1/\*3</sup> ↔  
3BAND EQ<sup>\*1/\*3/\*4/\*5</sup> ↔ SOURCE VOL ↔ SUBWOOFER<sup>\*7</sup> ↔  
SUBW LPF<sup>\*1/\*3/\*6/\*7</sup> ↔ SUBW PHASE<sup>\*6/\*7/\*8</sup> ↔ SUBW SYS<sup>\*3/\*6/\*7</sup> ↔  
POWER IC<sup>\*7</sup>  
(e.g. Select SUBWOOFER)

- \*1 Adjustment cannot be performed when DEFEAT is set to ON.
- \*2 Not displayed when the Audio Setup mode is activated by pressing **BASS** in MANUAL SET mode (page 18).
- \*3 These items are set uniformly in BASS ENGINE SQ mode by adjusting BASS ENGINE SQ Level (page 18) and cannot be adjusted separately. If you want to change these settings separately, a message is displayed asking you to confirm that you want to exit the BASS ENGINE SQ mode. Select "YES" to make the setting.
- \*4 Any changes made to either EQ PRESETS or 3BAND EQ are reflected in the other's settings.
- \*5 In step 3, three sound adjustment items (Bass, Mid and Treble) can be selected in 3BAND EQ mode. Turn the **Rotary encoder** to select the desired item, and then press **Q/ENTER** to continue to step 4.
- \*6 These functions are inoperable when SUBWOOFER is set to OFF.
- \*7 Only for CDE-182R/CDE-181 Series/CDE-180 Series.
- \*8 This function is inoperable when SUBW LPF is set to OFF (page 17).

- 4 Turn the **Rotary encoder** to change the setting, and then press **Q/ENTER**.

(e.g. Select SUBW ON or SUBW OFF)

- 5 Press and hold **AUDIO/SETUP** for at least 2 seconds to return to normal mode.

### Notes

- Pressing **↵** returns to the previous Sound menu mode.
- Pressing and holding **↵** for at least 2 seconds will return to normal mode.
- If no operation is performed for 60 seconds, Sound menu mode is cancelled.

## Equalizer Presets

10 typical equalizer settings are preset at the factory for a variety of musical source material. USER settings are created in the 3BAND EQ mode.

### Setting item: EQ PRESETS

#### Setting contents:

USER / FLAT (Initial setting) / POPS / ROCK / NEWS / JAZZ / ELEC DANCE / HIP HOP / EASY LIS / COUNTRY / CLASSICAL

## Setting BASS ENGINE SQ ON/OFF

This unit has a BASS ENGINE SQ feature for Sound adjustment.

### Setting item: BASS ENGIN

#### Setting contents:

OFF (Initial setting) / ON

#### OFF (MANUAL SET mode):

Adjust each audio effect setting separately.

#### ON (BASS ENGINE SQ mode):

Adjust the Bass relative audio effect settings uniformly by adjusting the BASS ENGINE SQ Level (page 18).

#### Notes

- You can also set BASS ENGINE SQ ON/OFF directly by pressing and holding **BASS**. Refer to "Setting BASS ENGINE SQ ON/OFF" on page 18.
- " indicator lights up when BASS ENGINE SQ mode is ON.
- With BASS ENGINE SQ ON, adjusting the BASS ENGINE SQ Level uniformly effects various sound parameters for optimum Bass effect. Refer to "Adjusting BASS ENGINE SQ Level" on page 18.

## Turning Loudness On/Off

Loudness introduces a special low-and high-frequency emphasis at low listening levels. This compensates for the ear's decreased sensitivity to bass and treble sound.

### Setting item: LOUDNESS

#### Setting contents:

LOUD OFF (Initial setting) / LOUD ON

## Adjusting the Parametric Equalizer Curve (3BAND EQ)

You can modify the Equalizer settings to create a response curve more appealing to your personal taste. The setting of Bass, Mid and Treble can be adjusted in this mode.

### Setting item: 3BAND EQ

### Further setting items: BASS / MID / TREBLE

## Setting the Control

- After selecting BASS/MID/TREBLE from the 3BAND EQ adjustment mode, turn the **Rotary encoder** to select the desired setting item, and then press **Q** / **ENTER**.  
WIDTH (Q) ↔ CENTER FRQ ↔ LEVEL
- Turn the **Rotary encoder** to select the desired setting value, and then press **Q** / **ENTER**.
- Press **↶** to return to the previous step.

### Setting the Bandwidth (WIDTH (Q))

<b>BASS</b>	WIDE 0.50 ↔ MEDIUM 1.00 ↔ MEDIUM 1.50 ↔ NARROW 2.00
<b>MID</b>	WIDE 0.75 ↔ MEDIUM 1.00 ↔ MEDIUM 1.25 ↔ NARROW 1.50
<b>TREBLE</b>	WIDE 0.75 ↔ NARROW 1.25

Changes the boosted bandwidth to wide or narrow. A wider setting will boost a wide range of frequencies above and below the centre frequency. A narrower setting will boost only frequencies near the centre frequency.

### Setting the Centre Frequency (CENTER FRQ)

<b>BASS</b>	60 (Hz) ↔ 80 (Hz) ↔ 100 (Hz) ↔ 120 (Hz)
<b>MID</b>	500 (Hz) ↔ 1.0K (Hz) ↔ 1.5K (Hz) ↔ 2.5K (Hz)
<b>TREBLE</b>	7.5K (Hz) ↔ 10.0K (Hz) ↔ 12.5K (Hz) ↔ 15.0K (Hz)

Emphasises the displayed frequency ranges.

### Setting the Level

<b>BASS</b>	-7 ~ +7
<b>MID</b>	-7 ~ +7
<b>TREBLE</b>	-7 ~ +7

You can emphasise or weaken the level.

#### Note

- The adjustment can also be made by pressing **AUDIO**. Refer to "Adjusting Subwoofer Level/Bass Level/Mid Level/Treble Level/Balance (Between Left and Right)/Fader (Between Front and Rear)/Loudness/Defeat" on page 15.

## Setting the Source Volume Level

The output level of each source is individually adjustable. For example, if the TUNER level sounds lower than CD, its output can be adjusted without affecting the other sources.

### Setting item: SOURCE VOL

### Further setting items: TUNER / DISC\*<sup>1</sup> / USB / iPod\*<sup>2</sup> / AUX

#### Setting contents:

-14 dB ~ +14 dB

\*<sup>1</sup> CDE-182R/CDE-181 Series/CDE-180 Series.

\*<sup>2</sup> CDE-182R/CDE-181 Series only.

## Turning Subwoofer ON/OFF

When the subwoofer is on, you can adjust the subwoofer output level (refer to "Adjusting Subwoofer Level/Bass Level/Mid Level/Treble Level/Balance (Between Left and Right)/Fader (Between Front and Rear)/Loudness/Defeat" on page 15).

### Setting item: SUBWOOFER

#### Setting contents:

OFF / ON (Initial setting)

#### OFF:

No subwoofer signal is output from the Subwoofer RCA Connectors (refer to "Connections" on page 33).

#### ON:

The subwoofer signal is output from the Subwoofer RCA Connectors (refer to "Connections" on page 33).



## Adjusting the Low Pass Filter

The Low Pass Filter on this unit can be adjusted to suit your personal taste.

**Setting item:** SUBW LPF

**Setting contents:**

OFF (Initial setting) / 60 (Hz) / 80 (Hz) / 120 (Hz) / 160 (Hz)  
All frequencies lower than the selected cutoff are output.

## Setting the Subwoofer Phase

The subwoofer output phase is toggled between SUBWOOFER NORMAL (0°) or SUBWOOFER REVERSE (180°). To adjust the level, turn the **Rotary encoder**.

**Setting item:** SUBW PHASE

**Setting contents:**

NORMAL (Initial setting) / REVERSE

## Setting the Subwoofer System

When the subwoofer is on, you can select either SYS 1 or SYS 2 for the desired subwoofer effect.

**Setting item:** SUBW SYS

**Setting contents:**

SUBW SYS 1 / SUBW SYS 2 (Initial setting)

**SUBW SYS 1:**

Subwoofer level changes according to the main volume setting.

**SUBW SYS 2:**

Subwoofer level change is different from the main volume setting. For example, even at low volume settings, the subwoofer is still audible.

## External Device

### Connecting to an External Amplifier (POWER IC)

When an external amplifier is connected, sound quality can be improved by stopping the power supply of the built-in amplifier.

**Setting item:** POWER IC

**Setting contents:**

OFF / ON (Initial setting)

**OFF:**

Use this mode when the line output of this unit is used to drive an external amplifier. In this setting, the head unit's internal amplifier is turned OFF and cannot drive speakers.

**ON:**

The speakers are driven by the built-in amplifier.

**OFF:**

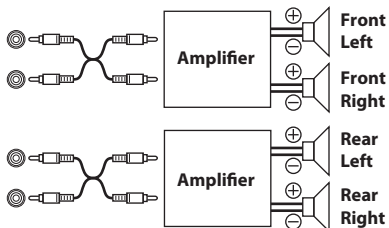

**ON:**

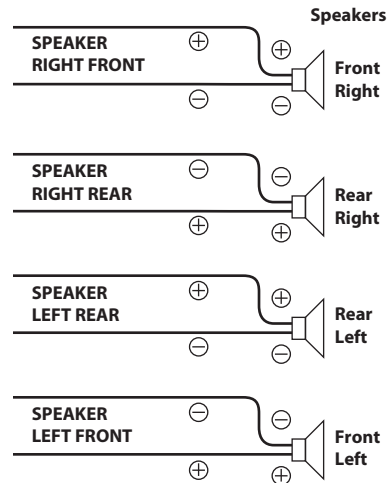

**Note**

- No sound is produced by the system when the power output is set to OFF.

# BASS ENGINE SQ Function

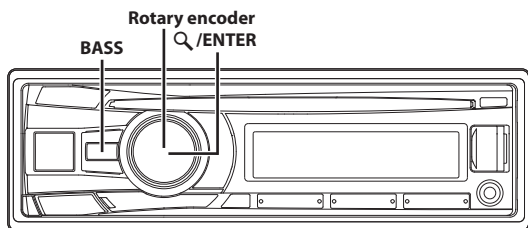

With the BASS ENGINE SQ function on this unit, several parameters affecting Bass performance are adjusted simultaneously. The BASS ENGINE SQ Level adjustment varies these parameters uniformly for optimum Bass effect at different levels.

## Setting BASS ENGINE SQ ON/OFF

Press and hold **BASS** for at least 2 seconds to switch the sound mode.

BASS ENGINE ↔ MANUAL SET (Initial setting)

### **BASS ENGINE SQ On (BASS ENGINE):**

Adjust the relevant Bass parameters uniformly by adjusting the BASS ENGINE SQ Level (page 18).

### **BASS ENGINE SQ Off (MANUAL SET):**

Adjust each audio effect setting separately.

### **Notes**

- This operation can also be performed by selected BASS ENGINE in Audio Setup mode. (Page 16)
- "BASS ENGINE SQ" indicator lights up when BASS ENGINE SQ mode is ON.

## Adjusting BASS ENGINE SQ Level

With BASS ENGINE SQ ON, adjusting the BASS ENGINE SQ Level uniformly effects various sound parameters for optimum Bass effect.

- 1 Press **Bass** to display the BASS ENGINE SQ Level adjustment screen.
- 2 Turn the **Rotary encoder** to select the desired level (0 ~ +6) (initial setting: +3), and then press **Q/ENTER**.

### **Notes**

- Adjustable only when DEFEAT is OFF.
- The Bass parameters affected contain EQ PRESETS, LOUDNESS, 3BAND EQ, SUBW LPF, SUBW SYS and SUBWOOFER Level. These items are set uniformly in BASS ENGINE SQ mode and cannot be adjusted separately.
- The value of BASS ENGINE SQ Level 0 is the same as the setting of DEFEAT ON and Subwoofer Level 0. From Level 1 to Level 6, the effect of BASS ENGINE SQ increases level by level.
- "BASS ENGINE SQ" indicator displays the current BASS ENGINE SQ Level.
- If no operation is performed for 5 seconds, the unit automatically returns to normal mode.

### **About Setup when the external power amplifier is connected. (CDE-182R/CDE-181 series/CDE-180 series only)**

In order to optimize the BASS ENGINE SQ, we recommend the following power amplifier setup.

After setting up, you can adjust the BASS ENGINE SQ Level according to the music.

- 1 Set gain of the power amplifier to "MIN".
- 2 Set the Crossover Mode Sector switch to "OFF".
- 3 Set the BASS ENGINE of this unit to "ON", and the BASS ENGINE SQ Level to "3".
- 4 Play a song of the genre you frequently listen to, and adjust gain of the power amplifier.

# Other Functions

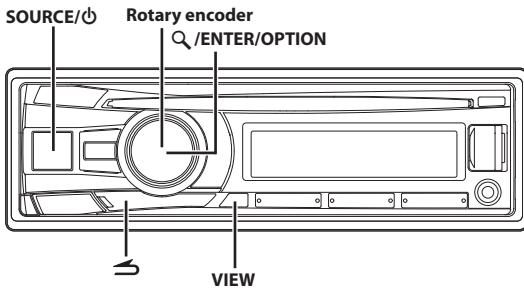

## Displaying the Text

Text information, such as the disc name and the track name, will be displayed if playing a CD text compatible disc. It is also possible to display the folder name, the file name and the tag, etc., while playing MP3/WMA/AAC files.

### Press **VIEW**.

The display will change every time the button is pressed.

### Note

- When the **TEXTSCROLL** is set to **SCR MANUAL** (refer to "Scroll Setting (**TEXTSCROLL**)" on page 21), press and hold **VIEW** for at least 2 seconds, the current text will be scrolled one time (except Radio mode).

### The display in Radio mode:

#### If there is PS (Programme Service Name)

PS (Programme Service Name)<sup>\*1</sup> → RADIO TEXT<sup>\*2</sup> → PTY (Programme Type)<sup>\*3</sup> → PS (Programme Service Name)

#### If there is no PS (Programme Service Name)

FREQUENCY → RADIO TEXT<sup>\*2</sup> → PTY (Programme Type)<sup>\*3</sup> → FREQUENCY

### The display in CD mode

#### (CDE-182R/CDE-181 Series/CDE-180 Series only):

TRACK NO./ELAPSED TIME → TEXT (DISC NAME)<sup>\*4</sup> → TEXT (TRACK NAME)<sup>\*4</sup> → TRACK NO./ELAPSED TIME

### The display in MP3/WMA/AAC mode:

FILE NO./ELAPSED TIME → FOLDER NO./FILE NO. → FOLDER NAME<sup>\*5</sup> → FILE NAME<sup>\*5</sup> → ARTIST NAME<sup>\*6</sup> → ALBUM NAME<sup>\*6</sup> → SONG NAME<sup>\*6</sup> → FILE NO./ELAPSED TIME

### The display in iPod mode (CDE-182R/CDE-181 Series only):

TRACK NO./ELAPSED TIME → ARTIST NAME<sup>\*6</sup> → ALBUM NAME<sup>\*6</sup> → SONG TITLE<sup>\*6</sup> → TRACK NO./ELAPSED TIME

<sup>\*1</sup> Press and hold **VIEW** for at least 2 seconds if PS is displayed in the radio mode, frequency will be displayed for 2 seconds.

<sup>\*2</sup> If there is no receivable text message or the unit cannot receive a text message properly, "NO TEXT" is displayed.

<sup>\*3</sup> If there is no receivable PTY broadcast, "NO PTY" is displayed.

<sup>\*4</sup> Displayed during playback of a disc with CD text. If there is no text (Disc Name or Track Name), "DISC TEXT"/"TRACK TEXT" is displayed.

<sup>\*5</sup> If there is no text (Folder Name or File Name), "FOLDER"/"FILE" is displayed.

<sup>\*6</sup> If an MP3/WMA/AAC file contains ID3 tag/WMA tag information, the ID3 tag/WMA tag information is displayed (e.g., song name, artist name, and album name). All other tag data is ignored. If there is no tag information, "ARTIST"/"ALBUM"/"SONG" is displayed.

## About "Text"

Text compatible CDs contain text information such as the disc name and track name. Such text information is referred to as "text".

### Notes

- Some characters may not be displayed correctly with this device, depending on the character type.
- "NO SUPPORT" is displayed if text information is not supported by the unit.
- The text or tag information may not be correctly displayed, depending on the contents.

## Using the Front AUX Input Terminal

Connect a portable music player, etc. by simply connecting it to the input on the front panel. An optional adapter cable is required (standard RCA to 3.5mm mini-phono plug or 3.5mm mini phono plug).

Press **SOURCE/⏻**, and select the **AUXILIARY** mode to listen to the portable device.

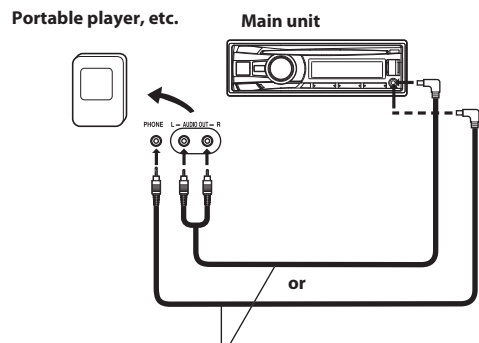

Optional adapter cable (RCA pin plugs [red, white] 3.5mm miniplugs) or (3.5mm miniplugs).

### Notes

- This function is available only when **AUX SETUP** is set to **ON**. For details, refer to "Setting the **AUX SETUP** mode" on page 21.
- If a USB Memory device is directly connected to the Front USB terminal, the size or shape may interfere with driving operations. Avoid making connections to the AUX Input and USB Input terminals at the same time.

## Option Menu Setting

You can quickly adjust the setting items relevant to the current SOURCE by using Option Menu.

- 1 Press and hold **Q / ENTER / OPTION** for at least 2 seconds to activate the Option menu of the current source.

### Note

- The option menu varies depending on the source.

- 2 Turn the **Rotary encoder** to select the desired setting item, and then press **Q / ENTER**.

- 3 Turn the **Rotary encoder** to change the setting, and then press **Q / ENTER**.

After the setting, the display will return to the current source automatically.

The following setting items are displayed when MENU LANG is set to ENGLISH. For details, refer to "Setting the Menu Language" on page 21.

### Setting item:

#### TUNER mode:

TUNER SET<sup>\*1</sup> ↔ SOURCE VOL<sup>\*2</sup> ↔ DIMMER<sup>\*3</sup>

#### DISC mode (CDE-182R/CDE-181 Series/CDE-180 Series only):

CD SET<sup>\*4</sup> ↔ SOURCE VOL<sup>\*2</sup> ↔ DIMMER<sup>\*3</sup>

#### USB mode:

SOURCE VOL<sup>\*2</sup> ↔ DIMMER<sup>\*3</sup>

#### iPod mode (CDE-182R/CDE-181 Series only):

APP DIRECT<sup>\*5</sup> ↔ iPod SET<sup>\*6</sup> ↔ SOURCE VOL<sup>\*2</sup> ↔ DIMMER<sup>\*3</sup>

#### AUX mode:

AUX SET<sup>\*7</sup> ↔ SOURCE VOL<sup>\*2</sup> ↔ DIMMER<sup>\*3</sup>

<sup>\*1</sup> The setting items are the same as TUNER setting in SETUP mode. For details, refer to "SETUP" on page 20.

<sup>\*2</sup> You can individually emphasise or weaken the volume level of the current source to create your own tonal preference. The setting values in Option mode and in SETUP mode are linkage. Refer to "Setting the Source Volume Level" on page 16.

<sup>\*3</sup> Refer to "Dimmer Control" on page 21.

<sup>\*4</sup> PLAY MODE can be selected in this mode. For details, refer to "Playing MP3/WMA/AAC Data (PLAY MODE) (CDE-182R/CDE-181 Series/CDE-180 Series only)" on page 21.

<sup>\*5</sup> Refer to "Setting the iPod Control" on page 23.

<sup>\*6</sup> The setting items are the same as iPod setting in SETUP mode. For details, refer to "iPod/iPhone Setting" on page 22.

<sup>\*7</sup> AUX NAME can be selected in this mode. For details, refer to "Setting the AUX NAME mode" on page 21.

### Notes

- Press **↩** to return to the previous mode.
- Pressing and holding **↩** for at least 2 seconds will return to normal mode.
- If no operation is performed for 60 seconds, the unit will return to normal mode automatically.

## SETUP

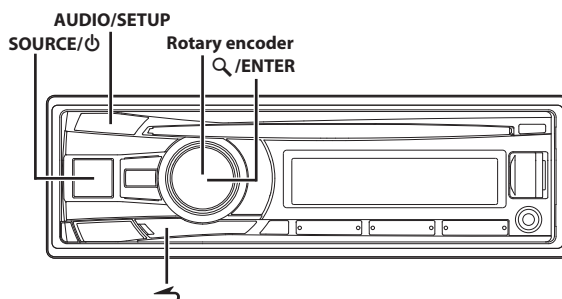

## Setting

You can flexibly customize the unit to suit your own preferences and usage. From the SETUP menu, GENERAL Setting, DISPLAY Setting, etc., can be modified.

**Use steps 1 to 5 to select one of the SETUP modes to modify. See the applicable section below for details about the selected SETUP item.**

- 1 Press and hold **AUDIO/SETUP** for at least 2 seconds to activate the SETUP mode.

- 2 Turn the **Rotary encoder** to select the desired item, and then press **Q / ENTER**.

(e.g. Select GENERAL)

AUDIO<sup>\*1</sup> ↔ GENERAL ↔ DISPLAY ↔ TUNER ↔ iPod<sup>\*2</sup>

#### GENERAL:

MENU LANG ↔ AUX SETUP<sup>\*3</sup> ↔ AUX NAME<sup>\*4</sup> ↔ PLAY MODE<sup>\*5</sup> ↔ DEMO MODE

#### DISPLAY:

DIMMER ↔ TEXTSCROLL

#### TUNER:

AF<sup>\*6</sup> ↔ REGIONAL<sup>\*7</sup> ↔ PI SEEK<sup>\*8</sup>

#### iPod:

iPod LIST

<sup>\*1</sup> Refer to "Audio Setup" on page 15.

<sup>\*2</sup> CDE-182R/CDE-181 Series only.

<sup>\*3</sup> Not displayed when the current source is AUXILIARY.

<sup>\*4</sup> Displayed only when AUX SETUP is set to ON.

<sup>\*5</sup> CDE-182R/CDE-181 Series/CDE-180 Series only.

<sup>\*6</sup> Refer to "Turning AF (Alternative Frequencies) ON/OFF" on page 10.

<sup>\*7</sup> Refer to "Receiving RDS Regional (Local) Stations" on page 11.

<sup>\*8</sup> Refer to "PI SEEK Setting" on page 11.

- 3 Turn the **Rotary encoder** to select a setting item, and then press **Q / ENTER**.

(e.g. Select AUX SETUP)

- 4 Turn the **Rotary encoder** to change the setting, and then press **Q / ENTER**.

(e.g. Select AUX ON or AUX OFF)

- 5 Press and hold **AUDIO/SETUP** for at least 2 seconds to return to normal mode.

## Notes

- Press **↶** to return to the previous mode.
- Pressing and holding **↶** for at least 2 seconds will return to normal mode.
- If no operation is performed for 60 seconds, the unit will return to normal mode automatically.

## General Setting

GENERAL is selected on the setup main menu in step 2.

## Setting the Menu Language

Set the language to be displayed on the unit.

### Setting item: MENU LANG

#### Setting contents:

ENGLISH (Initial setting) / RUSSIAN / GERMAN / FRENCH / SPANISH / ITALIAN / DUTCH

## Note

- The Owner's Manual only describes the setup menu display when ENGLISH is set.

## Setting the AUX SETUP mode

You can input the audio of an external device, (such as a Portable audio player) to the AUX connector of this unit.

### Setting item: AUX SETUP

#### Setting contents:

AUX OFF / AUX ON (Initial setting)

#### AUX OFF:

When set to OFF, AUX source cannot be selected.

#### AUX ON:

Set to ON when a portable device is connected. If **SOURCE/⊕** is pressed and AUX is selected, the sound of the portable device is input to the unit.

## Setting the AUX NAME mode

You can change the AUX NAME display in the SETUP mode.

### Setting item: AUX NAME

#### Setting contents:

AUXILIARY (Initial setting) / TV / DVD / PORTABLE / GAME

## Note

- PORTABLE is abbreviated as PMD in the display.

## Playing MP3/WMA/AAC Data (PLAY MODE) (CDE-182R/CDE-181 Series/CDE-180 Series only)

This unit can play back CDs containing both CD and MP3/WMA/AAC data (created in Enhanced CD (CD Extra) format). However, in some situations, playback of an enhanced CD may be difficult. In this case, you can choose to play back the CD data session only. When a disc contains both CD and MP3/WMA/AAC data, playback starts from the CD data portion of the disc.

### Setting item: PLAY MODE

#### Setting contents:

CD-DA / CDDA/MP3 (Initial setting)

#### CD-DA:

Only the CD data in Session 1 can be played back.

#### CDDA/MP3:

CD data, MP3/WMA/AAC files in mixed mode, and multi-session discs can be played back.

## Note

- Perform this setting before inserting a disc. If a disc has already been inserted, remove it first.

## Setting the Demonstration mode

This unit has a demonstration feature for display.

### Setting item: DEMO MODE

#### Setting contents:

ON (Initial setting) / OFF / QUITE OFF

#### ON:

The unit starts the demonstration if there is no operation for 30 seconds.

#### OFF:

Quit the demonstration mode. Note that if this unit is disconnected from the vehicle's battery, the next time you use this unit the DEMO mode will be ON.

#### QUITE OFF:

Quit the demonstration mode completely.

## Display Setting

DISPLAY is selected on the setup main menu in step 2.

## Dimmer Control

Set the Dimmer control to AUTO to decrease the illumination brightness of the unit with the head lights of the vehicle ON. This mode decreases the unit's backlighting at a certain extent at night.

### Setting item: DIMMER

#### Setting contents:

DIM MANUAL / DIM AUTO (Initial setting)

## Scroll Setting (TEXTSCROLL)

This CD player can scroll the disc and track names recorded on CD-TEXT discs, as well as the text information of MP3/WMA/AAC files, folder names, and tags.

### Setting item: TEXTSCROLL

#### Setting contents:

SCR MANUAL (Initial setting) / SCR AUTO

#### SCR MANUAL:

The above information is scrolled only when a disc is loaded, a channel or track is changed, etc.

#### SCR AUTO:

CD text information, folder and file names, and the tag information are scrolled continuously.

## Note

- In parts of the display, scrolling may not occur, or scroll content may differ.

## iPod/iPhone Setting

“iPod” is selected on the setup main menu in step 2.

## iPod/iPhone Search Mode Setting

The unit allows you to search the iPod/iPhone using nine different search modes.

■ **Setting item:** iPod LIST

■ **Further setting items:** PLAYLISTS / ARTISTS / ALBUMS / AUDIOBOOKS / PODCASTS / GENRES / COMPOSERS / SONGS / GENIUS MIX

**Setting contents:**  
OFF / ON

### Notes

- The search mode for Playlists/Artists/Albums/Podcasts/Genres/ Songs/ Genius Mix is initially set to On. The search mode for Audiobooks/ Composers is initially set to Off.
- For search mode details, refer to “Searching for a desired Song” on page 24.

## USB Memory (optional)

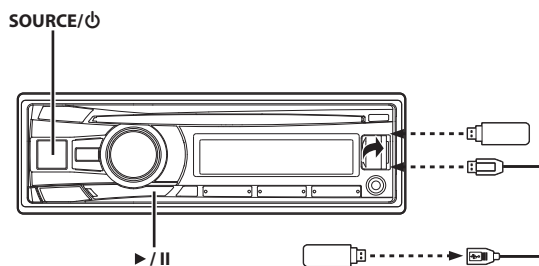

## Playing MP3/WMA/AAC Files from USB Memory (optional)

If you connect a USB memory device containing MP3/WMA/AAC, the files can be searched and played back.

- 1 Press **SOURCE/⏻** to switch to the USB AUDIO mode.
- 2 To pause playback, press **▶/||**.  
Pressing **▶/||** again will resume the playback.

### Notes

- This unit plays back files in USB Memory with the same controls and modes used for playback of CDs containing MP3/WMA/AAC. For details, refer to “CD/MP3/WMA/AAC (CDE-182R/CDE-181 Series/CDE-180 Series only)” on page 12.
- Before disconnecting USB Memory, be sure to change to another source or set to pause.
- The playback time may not be correctly displayed when a VBR (Variable Bit Rate) recorded file is played back.

## About MP3/WMA/AAC File of USB Memory

### Playing back MP3/WMA/AAC

MP3/WMA/AAC files are prepared, then stored to a USB Memory Device. This unit can recognise at most 100 folders and 100 files per folder stored in USB Memory. Playback may not be performed if a USB Memory Device exceeds the limitations described above. Do not make a file's playback time more than 1 hour.

### Media supported

This device can play back files stored on USB Memory devices designed for USB connection.

### Corresponding File Systems

This device supports FAT 12/16/32 for USB Memory devices.

# iPod/iPhone (optional) (CDE-182R/CDE-181 Series only)

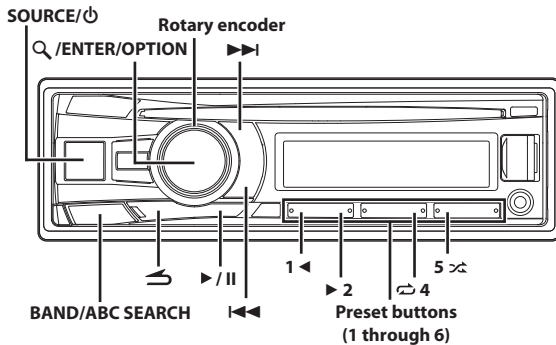

## Connecting an iPod/iPhone

An iPod/iPhone can be connected to this unit by using the Interface cable for iPod (included with iPod). When an iPod/iPhone is connected to this unit, you can choose to control the iPod/iPhone using its own controls or by the head unit controls. For details, refer to “Setting the iPod Control” on page 23.

These instructions refer to controlling the iPod/iPhone from this Head Unit (HU) only. Make sure iPod Control is set to HU MODE (HEAD UNIT). Refer to “Setting the iPod Control” on page 23. Refer to the iPod/iPhone manual for operations using the iPod/iPhone.

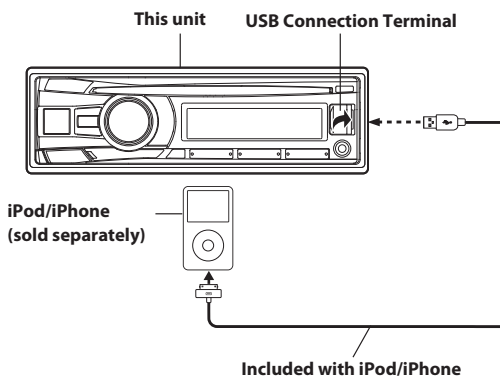

### Notes

- An iPhone connected to this unit operates as an iPod.
- Internet and telephone functions of iPod touch or iPhone, etc., can also be used when connecting to the unit. However, using these functions will stop or pause the playing songs. At this time do not operate the unit to avoid a malfunction.

### About iPod/iPhone models usable with this unit

- Confirmed devices regarding Made for iPod. Correct function of earlier versions cannot be guaranteed.
  - iPod nano (7th generation): Ver.1.0.2
  - iPod touch (5th generation): Ver.6.1.3
  - iPod touch (4th generation): Ver.6.1.3

- iPod nano (6th generation): Ver.1.2
- iPod touch (3rd generation): Ver.5.1.1
- iPod nano (5th generation): Ver.1.0.2
- iPod classic (160 GB) (Late 2009): Ver.2.0.4
- iPod touch (2nd generation): Ver.4.2.1
- iPod nano (4th generation): Ver.1.0.4
- iPod classic (120 GB): Ver.2.0.1
- iPod touch (1st generation): Ver.3.1.3
- iPod nano (3rd generation): Ver.1.1.3
- iPod classic (80 GB, 160 GB): Ver.1.1.2

- Confirmed devices regarding Made for iPhone. Correct function of earlier versions cannot be guaranteed.
  - iPhone 5: Ver.6.1.3
  - iPhone 4S: Ver.6.1.3
  - iPhone 4: Ver.6.1.3
  - iPhone 3GS: Ver.6.1.3
  - iPhone 3G: Ver.4.2.1
  - iPhone: Ver.3.1.3
- For clarity in identifying your model of iPod, please see Apple’s own document “Identifying iPod models” at <http://support.apple.com/kb/HT1353>
- This unit does not support video playback from iPod/iPhone, even using a video-compatible cable.

## Setting the iPod Control

When an iPod/iPhone is connected, operate it from its own controls or from the head unit.

- 1 Press and hold Q/ENTER/OPTION for at least 2 seconds in the iPod mode.**  
The Option menu for iPod mode is activated.
- 2 Turn the Rotary encoder to select “APP DIRECT”, and then press Q/ENTER.**

The iPod control mode will switch between iPod MODE and HU MODE.

### HU MODE (HEAD UNIT):

Operate the iPod/iPhone via this unit.

This mode allows you to use M.I.X. play, repeat and music search in an iPod/iPhone from the head unit.

### Note

- In HU MODE, if you operate from an iPod/iPhone, the head unit’s display and operations may not correspond with those of the iPod/iPhone.

### iPod MODE:

Operate the iPod/iPhone using its own controls. When iPod is selected, some functions will not be operable via the head unit.

### Notes

- During HU MODE, you can switch to iPod MODE directly by pressing **BAND**.
- Once the control mode is changed, the iPod/iPhone is paused. Press **▶/||** to continue.
- Depending upon the iPod used, iPod control may not be selectable. Or, if iPod is selected, operation must still be from the head unit.

## Playback

- 1 Press SOURCE/⏻ to switch to the iPod mode.**
- 2 Press ◀◀ or ▶▶ to select the desired song.**  
Pressing and holding ◀◀ or ▶▶ will fast backward/fast forward the current track.

- 3 To pause playback, press ►/II.**  
Pressing ►/II again will resume playback.

**Notes**

- A song playing on the iPod/iPhone while it is connected to this unit will continue to play from where it was paused after disconnection.
- If you listen to an episode from a selected Podcast or Audiobook, the episode can be changed by pressing 1 ◀ or ▶ 2.
- An episode may have several chapters. The chapter can be changed by pressing I◀◀ or ▶▶I.
- During iPod/iPhone playback, press ⏪, and then you can quickly return to the hierarchy level selected last time in the search mode.

## Searching for a desired Song

An iPod/iPhone can contain thousands of songs. Use one of the search modes listed below, that you deem most effective in finding a desired song.

Each music category has its own individual hierarchy. Use the Playlist/Artist/Album/Song/Podcast/Genre/Composer/Audiobook/Genius Mix List search mode to narrow searches based on the table below.

Hierarchy 1	Hierarchy 2	Hierarchy 3	Hierarchy 4
Playlist	Song	—	—
Artist*	Album*	Song	—
Album*	Song	—	—
Song	—	—	—
Podcast	Episode	—	—
Genre*	Artist*	Album*	Song
Composer*	Album*	Song	—
Audiobook	—	—	—
Genius Mix List	—	—	—

**Note**

- You can select your preferred search mode. Refer to “iPod/iPhone Search Mode Setting” on page 22.

**For example:**

Searching by Artist name

The following example explains how an ARTIST search is performed. Another search mode can be used for the same operation, although the hierarchy differs.

- 1 Press Q /ENTER to activate the search selection mode.**  
The “Q” indicator lights up.

- 2 Turn the Rotary encoder to select the ARTIST search mode, and then press Q /ENTER.**  
SHUFFLEALL\*1 ↔ PLAYLIST ↔ ARTIST ↔ ALBUM ↔ SONG ↔  
PODCAST\*2 ↔ GENRE ↔ COMPOSER ↔ AUDIOBOOK ↔  
GENIUS MIX\*3/\*4 ↔ SHUFFLEALL

\*1 Refer to “Random Play Shuffle (M.I.X.)” on page 25.  
\*2 Depending on the iPod/iPhone, podcast search is not supported.  
\*3 Depending on the connected iPod/iPhone, Genius Mix function may not be supported.  
\*4 When an iPod/iPhone with Genius Mix List created by iTunes is connected to this unit, GENIUS MIX search mode can be used to search a Genius Mix List.

**Note**

- The display of search mode list varies depending on the setting of iPod LIST. For details, refer to “iPod/iPhone Search Mode Setting” on page 22.

- 3 Turn the Rotary encoder to select the desired Artist, and then press Q /ENTER.**

- 4 Turn the Rotary encoder to select the desired Album, and then press Q /ENTER.**

- 5 Turn the Rotary encoder to select the desired Song, and then press Q /ENTER.**

**Notes**

- After pressing and holding Q /ENTER for at least 2 seconds while in each hierarchy (except Song, Audiobook and Genius Mix List), all songs of the selected hierarchy are played back.
- Playback [ALL] is only applicable for those categories marked with “\*”, (refer to the table on the left) press and hold Q /ENTER for at least 2 seconds to play back all songs in the iPod/iPhone or selected search mode.
- While in the search mode, if you press and hold ⏪ for 2 seconds, or no operation is performed for 10 seconds, the search mode is cancelled.
- In the search mode, pressing ⏪ will return to the previous mode.
- When search is made during M.I.X. play, the M.I.X. play mode will be cancelled.
- “NO SONG” will be displayed if there are no songs in the selected playlist in the PLAYLIST search mode.
- “NO PODCAST” will be displayed if there is no podcast data in the iPod/iPhone in the PODCAST search mode.
- “NO AUDIOBOOK” will be displayed if there is no audiobook data in the iPod/iPhone in AUDIOBOOK search mode.
- “NO GENIUS” will be displayed if there is no genius mix list data in the GENIUS MIX search mode.
- If “iPod name” stored in the iPod/iPhone is selected in the desired Playlist search mode, and Q /ENTER is pressed, you can search for all songs in the iPod/iPhone. Also, if you press and hold Q /ENTER for at least 2 seconds, all songs in the iPod/iPhone are played back.
- Press any of the **preset buttons (1 through 6)** during a search to skip over a calculated percentage of songs. For details, refer to “Direct Search Function” on page 25.
- During search mode, a search can be made quickly by Alphabet search function to find the desired artist or song, etc. For details, refer to “Alphabet search function” on page 24.

## Alphabet search function

The unit’s alphabet search function can be used to search for an album, song, etc., more efficiently. In PLAYLIST/ARTIST/ALBUM/SONG/PODCAST/GENRE/COMPOSER/AUDIOBOOK search mode, select the first letter of your desired title (album, song, etc.), the titles beginning with this letter are listed. By using this function, you can quickly target any song.

- 1 After selecting a search mode, press BAND/ABC SEARCH.**  
The letter selection list is displayed.
- 2 Turn the Rotary encoder to select a desired letter (e.g. M), and then press Q /ENTER.**  
The titles beginning with “M” are listed.
- 3 Turn the Rotary encoder to select the desired title.**

**Notes**

- While in Alphabet search mode, pressing ⏪ will return to the previous mode.
- If the PLAYLIST search mode is used to search for a song, the Alphabet search function is inactive in the song search hierarchy.
- This function is unavailable when Genius Mix List is selected.



## Direct Search Function

The unit's direct search function can be used to search for an album, song, etc., more efficiently. In PLAYLIST/ARTIST/ALBUM/SONG/PODCAST/GENRE/COMPOSER/AUDIOBOOK mode, you can quickly target any song.

**In the search mode, press any one of the preset buttons (1 through 6) to quickly skip over a designated percent of your song content.**

### Song search example:

If there are 100 songs in your iPod/iPhone, they are divided into 6 groups using percentages (shown below). These groups are assigned to the preset buttons (1 through 6).

### Example 1:

Suppose the song you are searching for is located at around the middle (50%) of your library: press button 4 to jump to the 50th song and turn the **Rotary encoder** to find the desired song.

### Example 2:

Suppose the song you are searching for is located near the end (83%) of your library: press button 6 to jump to the 83rd song and turn the **Rotary encoder** to find the desired song.

	All 100 songs (100%)					
	0%	17%	33%	50%	67%	83%
Preset buttons	1	2	3	4	5	6
Songs	1st song	17th song	33rd song	50th song	67th song	83rd song

### Notes

- This function is also applicable to CD/MP3/WMA/AAC search.
- This function is inactive during Alphabet Search mode.

## Select Playlist/Artist/Album/Genre/Composer

Playlist/Artist/Album/Genre/Composer can be easily changed. For example, if you listen to a song from a selected album, the album can be changed.

**Press 1 ◀ or ▶ 2 to select the desired Playlist/Artist/Album/Genre/Composer.**

### Notes

- If the song search mode was used to select a song, this function is inactive.
- If an album is selected during an artist search, other albums by that artist are searchable.
- This function is inactive during shuffle (🔀) playback.

## Random Play Shuffle (M.I.X.)

The Shuffle function of the iPod/iPhone is displayed as 🔀 on this unit.

### Shuffle Albums:

The songs on each album are played back in proper order. Upon completion of all the songs on the album, the next album is selected randomly. This continues until all albums have been played.

### Shuffle Songs:

Song shuffle randomly plays back songs within a selected category (playlist, album, etc.). The songs within the category are played just once until all songs have been played.

### 1 Press 5 🔀.

The songs are played back randomly.

🔀\*1 → 🔀\*2 → (off) → 🔀

\*1 Shuffle Albums.

\*2 Shuffle Songs.

### 2 To cancel M.I.X. play, select (off) with the above procedure.

#### Note

- If a song is selected in the album search mode before selecting M.I.X. play, the songs will not play back randomly even when Shuffle Albums is selected.

### Shuffle ALL:

Shuffle ALL plays all songs in the iPod/iPhone randomly. Any one song does not play back again until all songs have been played back.

### 1 Press 🔍/ENTER to activate the search selection mode.

### 2 Turn the Rotary encoder to select SHUFFLEALL, and then press 🔍/ENTER.

The "ALL 🔀" indicator lights up.

To cancel M.I.X. play, press 5 🔀 to select OFF.

#### Note

- If Shuffle ALL is selected, the selected songs being played back in the search mode are cancelled.

## Repeat Play

Only Repeat One is available for the iPod/iPhone.

### Repeat One:

A single song is repeatedly played back.

### 1 Press 🔁 4.

The song is played back repeatedly.

🔁\* → (off) → 🔁

\* Repeat One.

### 2 To cancel repeat play, select (off) with the above procedure.

#### Note

- During repeat playback, no other songs are selectable by pressing ⏮ or ⏭.

# Information

## In Case of Difficulty

If you encounter a problem, please turn the power off, then on again. If the unit is still not functioning normally, please review the items in the following checklist. This guide will help you isolate the problem if the unit is at fault. Otherwise, make sure the rest of your system is properly connected or consult your authorized Alpine dealer.

### Basic

#### No function or display.

- Vehicle's ignition is off.
  - If connected following instructions, the unit will not operate with the vehicle's ignition off.
- Improper power lead (Red) and battery lead (Yellow) connections.
  - Check power lead and battery lead connections.
- Blown fuse.
  - Check the fuse of the unit; replace with the proper value if necessary.

### Radio

#### Unable to receive stations.

- No antenna or open connection in cable.
  - Make sure the antenna is properly connected; replace the antenna or cable if necessary.

#### Unable to tune stations in the seek mode.

- You are in a weak signal area.
  - Make sure the tuner is in the DX mode.
- If the area you are in is a primary signal area, the antenna may not be grounded and connected properly.
  - Check your antenna connections; make sure the antenna is properly grounded at its mounting location.
- The antenna may not be the proper length.
  - Make sure the antenna is fully extended; if broken, replace the antenna with a new one.

#### Broadcast is noisy.

- The antenna is not the proper length.
  - Extend the antenna fully; replace it if it is broken.
- The antenna is poorly grounded.
  - Make sure the antenna is grounded properly at its mounting location.

### CD (CDE-182R/CDE-181 Series/CDE-180 Series only)

#### CD Player not functioning.

- Out of operating temperature range +50°C (+120°F) for CD.
  - Allow the vehicle's interior (or trunk) temperature to cool.

#### CD playback sound is wavering.

- Moisture condensation in the CD Module.
  - Allow enough time for the condensation to evaporate (about 1 hour).

#### CD insertion not possible.

- A CD is already in the CD player.
  - Eject the CD and remove it.
- The CD is being improperly inserted.
  - Make sure the CD is being inserted following instructions in the CD Player Operation section.

#### Unable to fast forward or backward the CD.

- The CD has been damaged.
  - Eject the CD and discard it; using a damaged CD in your unit can cause damage to the mechanism.

#### CD playback sound skips due to vibration.

- Improper mounting of the unit.
  - Securely re-mount the unit.
- The disc is very dirty.
  - Clean the disc.
- The disc has scratches.
  - Change the disc.
- The pick-up lens is dirty.
  - Do not use a commercially available lens cleaner disc. Consult your nearest Alpine dealer.

#### CD playback sound skips without vibration.

- The disc is dirty or scratched.
  - Clean the disc; damaged disc should be replaced.

#### Error displays (built-in CD player only).

- Mechanical error
  - Press . After the error indication disappears, insert the disc again. If the above-mentioned solution does not solve the problem, consult your nearest Alpine dealer.

#### CD-R/CD-RW playback not possible.

- Close session (finalisation) has not been performed.
  - Perform finalisation and attempt playback again.

### MP3/WMA/AAC

#### MP3/WMA/AAC is not played back.

- Writing error occurred. The MP3/WMA/AAC format is not compatible.
  - Make sure the MP3/WMA/AAC has been written in a supported format. Refer to "About MP3/WMA/AAC" on page 13, and then rewrite in the format supported by this device.

### Audio

#### The sound is not output from the speakers.

- Unit has no output signal of the internal amplifier.
  - POWER IC is switched to "ON"; refer to "Connecting to an External Amplifier (POWER IC)" on page 17 (CDE-182R/CDE-181 Series only).

### iPod (CDE-182R/CDE-181 Series only)

#### iPod does not play and no sound is output.

- The iPod has not been recognised.
  - Reset the iPod.

## Indication for CD Player (CDE-182R/CDE-181 Series/CDE-180 Series only)

### NO DISC

- No CD is inserted.
  - Insert a CD.
- Although a disc is inserted, “NO DISC” is displayed and the unit does not start to play or eject the disc.
  - Remove the disc by following these steps:  
Press the **▲** button again for at least 2 seconds.  
If the disc still does not eject, consult your Alpine dealer.

### ERROR

- Mechanism error.
  - 1 **Press the **▲** button and eject the CD.**  
If not ejecting, consult your Alpine dealer.
  - 2 **When the error indication remains after ejecting, press the **▲** button again.**  
If the error indication still does not turn off after pressing the **▲** button for a few times, consult your Alpine dealer.

### PROTECT

- A copy-protected WMA file was played back.
  - You can only play back non-copy-protected files.

### UNSUPPORTED

- A sampling rate/bit rate not supported by the unit is used.
  - Use a sampling rate/bit rate that is supported by the unit.

## Indication for USB Memory

### DEVICE ERR

- A USB device that is not supported by the unit is connected.
  - Connect a USB device that is supported by the unit.

### NO DEVICE

- A USB Memory Device is not connected.
  - Make sure the USB Memory device is correctly connected and the cable is not excessively bent.

### NO FILE

- No MP3/WMA/AAC (file) is stored in the USB Memory.
  - Connect the USB Memory device after storing songs (files).

### PROTECT

- A copy-protected WMA file was played back.
  - You can only play back non-copy-protected files.

### UNSUPPORTED

- A sampling rate/bit rate not supported by the unit is used.
  - Use a sampling rate/bit rate that is supported by the unit.

### NO SUPPORT

- Text information that is not recognisable by the unit has been input.
  - Use a USB Memory device with input text information that is supported by the unit.

### ERROR

- Communication error or others
  - Change to other source.
  - Turn the power off.
  - Turn the ignition key off, and then set to ON again.

### ERROR-01

- Communication error
  - Turn the ignition key off, and then set to ON again.
  - Check the display by reconnecting between the USB Memory and this unit.

### ERROR-04

- Power surge error  
Excessive voltage/current is supplied to the USB Memory.
  - Try another USB Memory, if available.

## Indication for iPod Mode (CDE-182R/CDE-181 Series only)

### NO DEVICE

- The iPod/iPhone is not connected.
  - Make sure the iPod/iPhone is correctly connected.  
Make sure the cable is not bent excessively.

### NO SONG

- There are no songs in the iPod/iPhone.
  - Download songs to the iPod/iPhone and connect to this unit.

### ERROR-01

- Communication error
  - Turn the ignition key off, and then set to ON again.
  - Check the display by reconnecting between the iPod/iPhone and this unit, using the iPod/iPhone cable.

## **ERROR-02**

- Caused by the iPod/iPhone Software Version not being compatible with this unit.
    - Update the iPod/iPhone Software Version to be compatible with this unit.
- 

## **ERROR-03**

- The iPod/iPhone is not verified.
    - Reset the iPod.
    - Try another iPod/iPhone, if available.
- 

## **ERROR-04**

- Power surge error  
Excessive voltage/current is supplied to the iPod/iPhone.
    - Try another iPod/iPhone, if available.
    - Turn the power off.
    - Turn the ignition key off, and then set to ON again.
-

## Specifications

### FM TUNER SECTION

Tuning Range	87.5 ~ 108.0 MHz
Mono Usable Sensitivity	0.7 $\mu$ V
Alternate Channel Selectivity	80 dB
Signal-to-Noise Ratio	65 dB
Stereo Separation	35 dB
Capture Ratio	2.0 dB

### MW TUNER SECTION

Tuning Range	531 ~ 1,602 kHz
Sensitivity (IEC Standard)	25.1 $\mu$ V/28 dB

### LW TUNER SECTION

Tuning Range	153 ~ 281 kHz
Sensitivity (IEC Standard)	31.6 $\mu$ V/30 dB

### CD PLAYER SECTION

#### (CDE-182R/CDE-181 Series/CDE-180 Series only)

Frequency Response	5 ~ 20,000 Hz ( $\pm$ 1 dB)
Wow & Flutter (% WRMS)	Below measurable limits
Total Harmonic Distortion	0.008% (at 1 kHz)
Dynamic Range	95 dB (at 1 kHz)
Signal-to-Noise Ratio	105 dB
Channel Separation	85 dB (at 1 kHz)

### USB SECTION

USB requirements	USB 1.1/2.0
Max. Power Consumption	1,000 mA
USB Class	Mass Storage
File System	FAT 12/16/32
MP3 Decoding	MPEG AUDIO Layer-3
WMA Decoding	Windows Media™ Audio
AAC Decoding	AAC-LC format "m4a" file

### PICKUP

Wave length	795 nm
Laser power	CLASS I

### GENERAL

Power Requirement	14.4 V DC (11 ~ 16 V allowable)
Maximum Power Output	50 W $\times$ 4
Maximum Pre-Output Voltage (CDE-182R/CDE-181 Series/ CDE-180 Series only)	2 V/10 k ohms
Bass	$\pm$ 14 dB at 100 Hz
Mid	$\pm$ 14 dB at 1 kHz
Treble	$\pm$ 14 dB at 10 kHz
CDE-182R/CDE-181 Series/CDE-180 Series:	
Weight	1.24 kg (2 lbs. 11 oz)
UTE-81R:	
Weight	0.9 kg (1lbs. 15 oz)

### CHASSIS SIZE

Width	178 mm (7")
Height	50 mm (2")
Depth	161.5 mm (6-3/8")

### NOSEPIECE SIZE

Width	170 mm (6-3/4")
Height	46 mm (1-13/16")
Depth	25 mm (1")

### Note

- Due to continuous product improvement, specifications and design are subject to change without notice.

### ⚠ CAUTION



(Bottom side of player)

- iPhone, iPod, iPod classic, iPod nano, and iPod touch are trademarks of Apple Inc., registered in the U.S. and other countries.
- "Made for iPod," and "Made for iPhone," mean that an electronic accessory has been designed to connect specifically to iPod, or iPhone, respectively, and has been certified by the developer to meet Apple performance standards. Apple is not responsible for the operation of this device or its compliance with safety and regulatory standards. Please note that the use of this accessory with iPod, or iPhone may affect wireless performance.
- Windows Media and the Windows logo are trademarks, or registered trademarks of Microsoft Corporation in the United States and/or other countries.
- MPEG Layer-3 audio coding technology licensed from Fraunhofer IIS and Thomson. Supply of this product only conveys a licence for private, non-commercial use and does not convey a licence nor imply any right to use this product in any commercial (i.e. revenue-generation) real time broadcasting (terrestrial, satellite, cable and/or any other media), broadcasting/streaming via internet, intranets and/or other networks or in other electronic content distribution systems, such as pay-audio or audio-on-demand applications. An independent licence for such use is required. For details, please visit <http://www.mp3licensing.com>

---

---

# Installation and Connections

Before installing or connecting the unit, please read the following and refer to "Operating Instructions" on page 5 for proper use.

## WARNING

---

### MAKE THE CORRECT CONNECTIONS.

Failure to make the proper connections may result in fire or product damage.

---

### USE ONLY IN CARS WITH A 12 VOLT NEGATIVE GROUND.

(Check with your dealer if you are not sure.) Failure to do so may result in fire, etc.

---

### BEFORE WIRING, DISCONNECT THE CABLE FROM THE NEGATIVE BATTERY TERMINAL.

Failure to do so may result in electric shock or injury due to electrical shorts.

---

### DO NOT SPLICE INTO ELECTRICAL CABLES.

Never cut away cable insulation to supply power to other equipment. Doing so will exceed the current carrying capacity of the wire and result in fire or electric shock.

---

### DO NOT DAMAGE PIPE OR WIRING WHEN DRILLING HOLES.

When drilling holes in the chassis for installation, take precautions so as not to contact, damage or obstruct pipes, fuel lines, tanks or electrical wiring. Failure to take such precautions may result in fire.

---

### DO NOT USE BOLTS OR NUTS IN THE BRAKE OR STEERING SYSTEMS TO MAKE GROUND CONNECTIONS.

Bolts or nuts used for the brake or steering systems (or any other safety-related system), or tanks should NEVER be used for installations or ground connections. Using such parts could disable control of the vehicle and cause fire etc.

---

### KEEP SMALL OBJECTS SUCH AS BATTERIES OUT OF THE REACH OF CHILDREN.

Swallowing them may result in serious injury. If swallowed, consult a physician immediately.

---

### DO NOT INSTALL IN LOCATIONS WHICH MIGHT HINDER VEHICLE OPERATION, SUCH AS THE STEERING WHEEL OR SHIFT LEVER.

Doing so may obstruct forward vision or hamper movement etc. and results in serious accident.

---

### DO NOT ALLOW CABLES TO BECOME ENTANGLED IN SURROUNDING OBJECTS.

Arrange wiring and cables in compliance with the manual to prevent obstructions when driving. Cables or wiring that obstruct or hang up on places such as the steering wheel, shift lever, brake pedals, etc. can be extremely hazardous.

---

## CAUTION

---

### HAVE THE WIRING AND INSTALLATION DONE BY EXPERTS.

The wiring and installation of this unit requires special technical skill and experience. To ensure safety, always contact the dealer where you purchased this product to have the work done.

---

### USE SPECIFIED ACCESSORY PARTS AND INSTALL THEM SECURELY.

Be sure to use only the specified accessory parts. Use of other than designated parts may damage this unit internally or may not securely install the unit in place. This may cause parts to become loose resulting in hazards or product failure.

---

### ARRANGE THE WIRING SO IT IS NOT CRIMPED OR PINCHED BY A SHARP METAL EDGE.

Route the cables and wiring away from moving parts (like the seat rails) or sharp or pointed edges. This will prevent crimping and damage to the wiring. If wiring passes through a hole in metal, use a rubber grommet to prevent the wire's insulation from being cut by the metal edge of the hole.

---

### DO NOT INSTALL IN LOCATIONS WITH HIGH MOISTURE OR DUST.

Avoid installing the unit in locations with high incidence of moisture or dust. Moisture or dust that penetrates into this unit may result in product failure.

---

## PRECAUTIONS

- Be sure to disconnect the cable from the (-) battery post before installing your CDE-182R/CDE-181 Series/CDE-180 Series/UTE-81R. This will reduce any chance of damage to the unit in case of a short-circuit.
- Be sure to connect the colour coded leads according to the diagram. Incorrect connections may cause the unit to malfunction or damage to the vehicle's electrical system.
- When making connections to the vehicle's electrical system, be aware of the factory installed components (e.g. on-board computer). Do not tap into these leads to provide power for this unit. When connecting the CDE-182R/CDE-181 Series/CDE-180 Series/UTE-81R to the fuse box, make sure the fuse for the intended circuit of the CDE-182R/CDE-181 Series/CDE-180 Series/UTE-81R has the appropriate amperage. Failure to do so may result in damage to the unit and/or the vehicle. When in doubt, consult your Alpine dealer.
- The CDE-182R/CDE-181 Series/CDE-180 Series/UTE-81R uses female RCA-type jacks for connection to other units (e.g. amplifier) having RCA connectors. You may need an adaptor to connect other units. If so, please contact your authorized Alpine dealer for assistance.
- Be sure to connect the speaker (-) leads to the speaker (-) terminal. Never connect left and right channel speaker cables to each other or to the vehicle body.

## IMPORTANT

Please record the serial number of your unit in the space provided below and keep it as a permanent record. The serial number or the engraved serial number is located on the bottom of the unit.

SERIAL NUMBER: [	]
INSTALLATION DATE: [	]
INSTALLATION TECHNICIAN: [	]
PLACE OF PURCHASE: [	]

## Installation

### To prevent external noise from entering the audio system.

- Locate the unit and route the leads at least 10 cm away from the car harness.
- Keep the battery power leads as far away from other leads as possible.
- Connect the ground lead securely to a bare metal spot (remove any paint, dirt or grease if necessary) of the car chassis.
- If you add an optional noise suppressor, connect it as far away from the unit as possible. Your Alpine dealer carries various noise suppressors, contact them for further information.
- Your Alpine dealer knows best about noise prevention measures so consult your dealer for further information.

## CAUTION

When you install this unit in your car, do not remove the detachable front panel.

If the detachable front panel is removed during installation, you might press too hard and warp the metal plate that holds it in place.

The main unit must be mounted within 35 degrees of the horizontal plane, back to front.

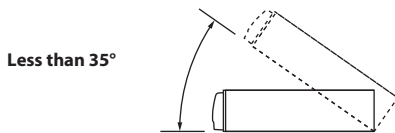

- 1 Remove the mounting sleeve from the main unit (refer to "Removal" on page 31). Slide the mounting sleeve into the dashboard and fix it with the metal shackles.

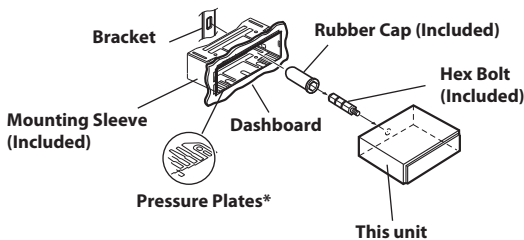

\* If the installed mounting sleeve is loose in the dashboard, the pressure plates may be bent slightly to remedy the problem.

- 2 When your vehicle has the Bracket, mount the long hex bolt onto the rear panel of the CDE-182R/CDE-181 Series/CDE-180 Series/UTE-81R and put the Rubber Cap on the hex bolt. If your vehicle does not have the Mounting Support, reinforce the head unit with the metal mounting strap (not supplied). Connect all the leads of the CDE-182R/CDE-181 Series/CDE-180 Series/UTE-81R according to details described in the CONNECTIONS section.

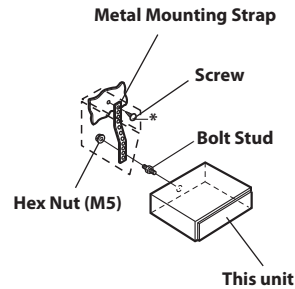

\* For the screw\*, provide a proper screw to the chassis installing location.

- 3 Slide the CDE-182R/CDE-181 Series/CDE-180 Series/UTE-81R into the dashboard until it clicks. This ensures that the unit is properly locked and will not accidentally come out from the dashboard. Install the detachable front panel.

## Removal

- 1 Remove the detachable front panel.
- 2 Insert the bracket keys into the unit, along the guides on either side. The unit can now be removed from the mounting sleeve.

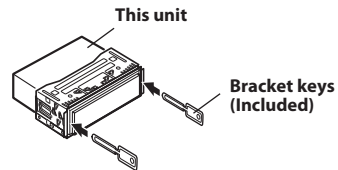

**3** Pull the unit out, keeping it unlocked as you do so.

JAPANESE CAR

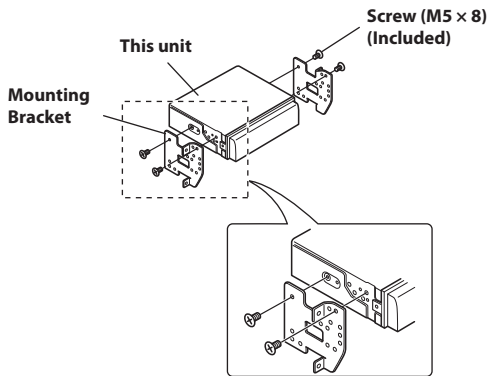
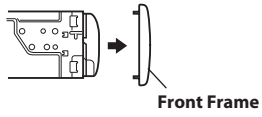



# Connections

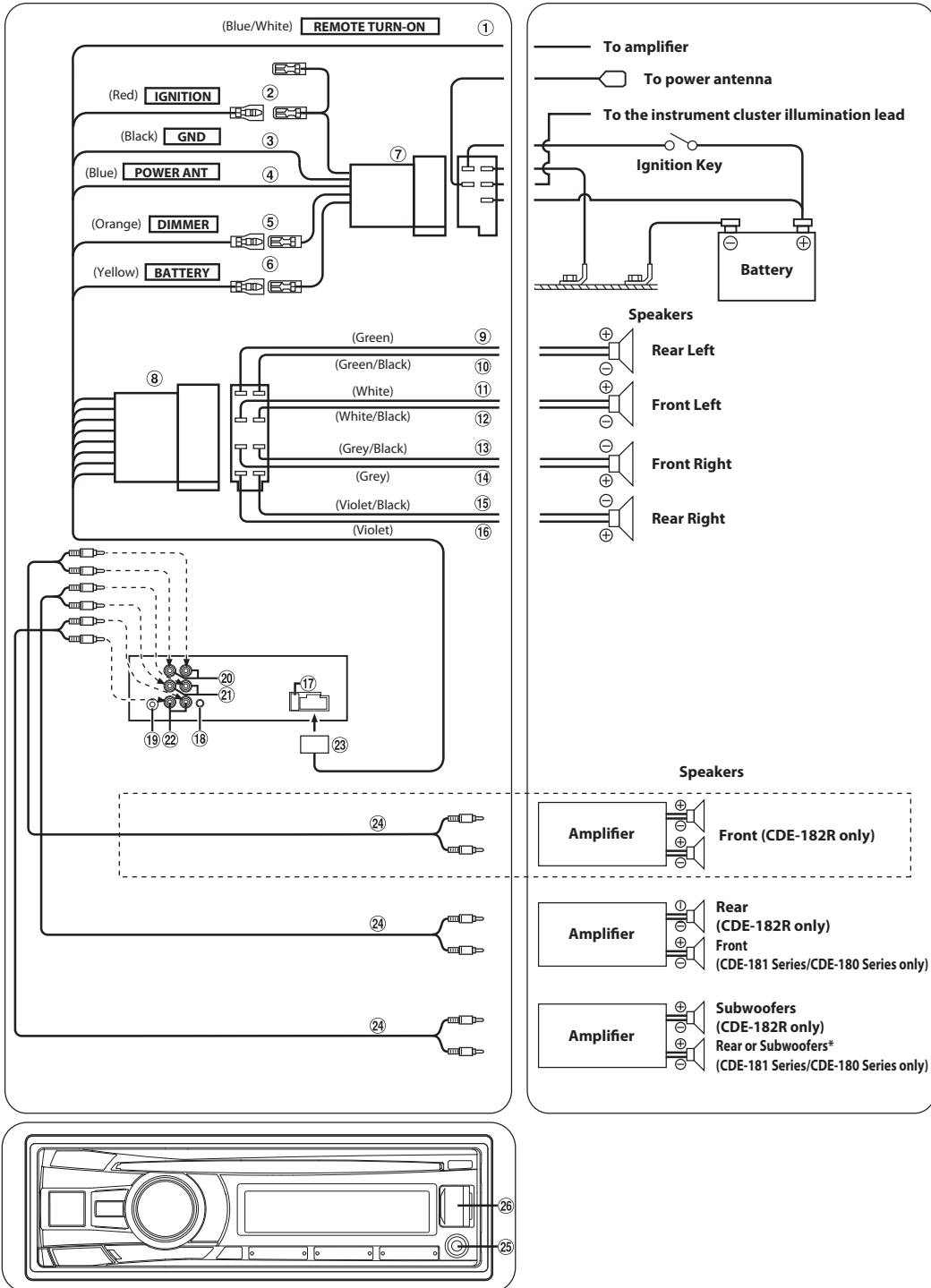

\* When Subwoofer is OFF: Output is for Rear speakers. When Subwoofer is ON: Output is for Subwoofer. For details on how to set the Subwoofer to ON/OFF, refer to "Turning Subwoofer ON/OFF" on page 16.

- ① **Remote Turn-On Lead (Blue/White)**  
Connect this lead to the remote turn-on lead of your amplifier or signal processor.
- ② **Switched Power Lead (Ignition) (Red)**  
Connect this lead to an open terminal on the vehicle's fuse box or another unused power source which provides (+) 12V only when the ignition is turned on or in the accessory position.
- ③ **Ground Lead (Black)**  
Connect this lead to a good chassis ground on the vehicle. Make sure the connection is made to bare metal and is securely fastened using the sheet metal screw provided.
- ④ **Power Antenna Lead (Blue)**  
Connect this lead to the +B terminal of your power antenna, if applicable.  
**Note**
  - *This lead should be used only for controlling the vehicle's power antenna. Do not use this lead to turn on an amplifier or a signal processor, etc.*
- ⑤ **Dimmer Lead (Orange)**  
This lead may be connected to the vehicle's instrument cluster illumination lead. This will enable the vehicle's dimmer control to dim the backlighting of the unit.
- ⑥ **Battery Lead (Yellow)**  
Connect this lead to the positive (+) post of the vehicle's battery.
- ⑦ **ISO Power Supply Connector**
- ⑧ **ISO Connector (Speaker Output)**
- ⑨ **Left Rear (+) Speaker Output Lead (Green)**
- ⑩ **Left Rear (-) Speaker Output Lead (Green/Black)**
- ⑪ **Left Front (+) Speaker Output Lead (White)**
- ⑫ **Left Front (-) Speaker Output Lead (White/Black)**
- ⑬ **Right Front (-) Speaker Output Lead (Grey/Black)**
- ⑭ **Right Front (+) Speaker Output Lead (Grey)**
- ⑮ **Right Rear (-) Speaker Output Lead (Violet/Black)**
- ⑯ **Right Rear (+) Speaker Output Lead (Violet)**
- ⑰ **Fuse Holder (10A)**
- ⑱ **Steering Remote Control Interface Connector (CDE-182R/ CDE-181 Series/CDE-180 Series only)**  
To steering remote control interface box.  
You can operate this unit from the vehicle's control unit when an Alpine Steering Remote Control Interface Box (optional) is connected. For details, contact your Alpine dealer.
- ⑲ **Antenna Receptacle**
- ⑳ **Front Output RCA Connectors (CDE-182R only)**  
RED is right and WHITE is left.
- ㉑ **Rear Output RCA Connectors (CDE-182R only)**  
RED is right and WHITE is left.
- ㉒ **Front Output RCA Connectors (CDE-181 Series/CDE-180 Series only)**  
RED is right and WHITE is left.
- ㉓ **Subwoofer Output RCA Connectors (CDE-182R only)**
- ㉔ **Rear/Subwoofer Output RCA Connectors (CDE-181 Series/ CDE-180 Series only)**  
RED is right and WHITE is left.
- ㉕ **Power Supply Connector**
- ㉖ **RCA Extension Cable (sold separately)**
- ㉗ **Front AUX Input Terminal**  
This terminal allows for input of audio from an external device (such as a portable player), using a commercially-available converter cable.
- ㉘ **USB Terminal**  
Connect this to a USB Memory or an iPod/iPhone (sold separately).