

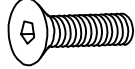



# ASSEMBLY INSTRUCTION

<b>A</b>  M6x13 x4	<b>B</b>  M6x40 x4	<b>C</b>  x1	<b>①</b>  x1	<b>②</b>  x1	<b>③</b>  x1
---	---	---	---	--	---

## STEP 1

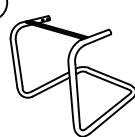

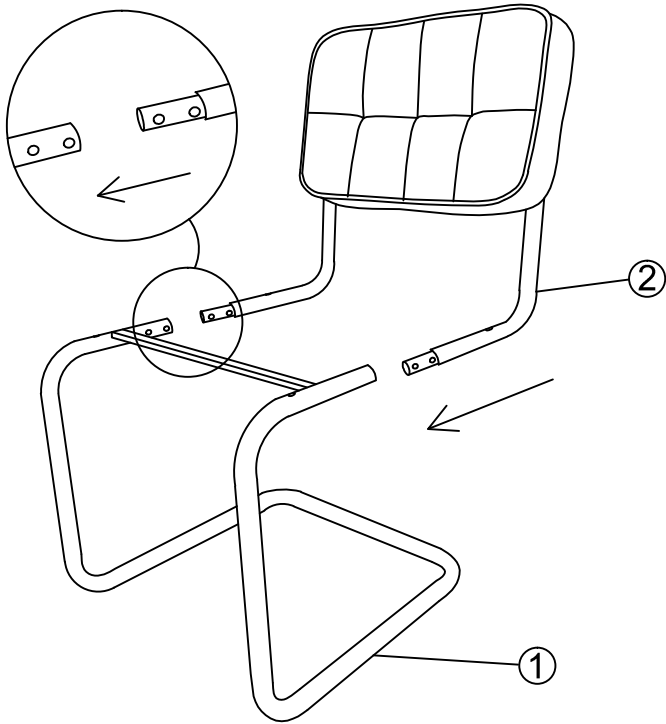
## STEP 2 Please tighten the 4 screws with 70%

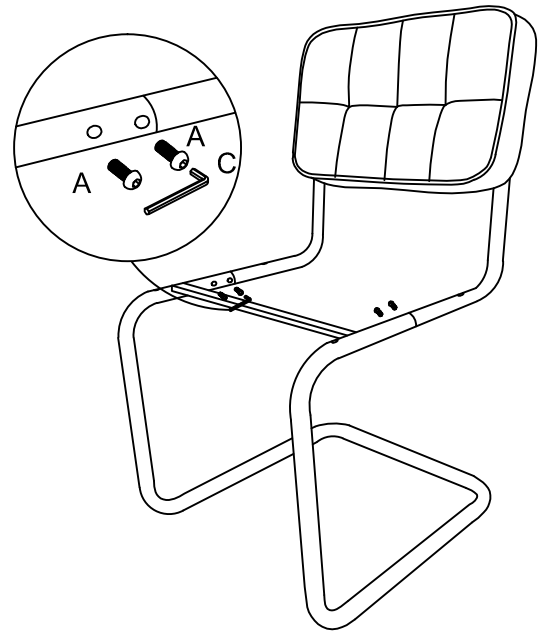
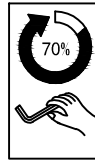



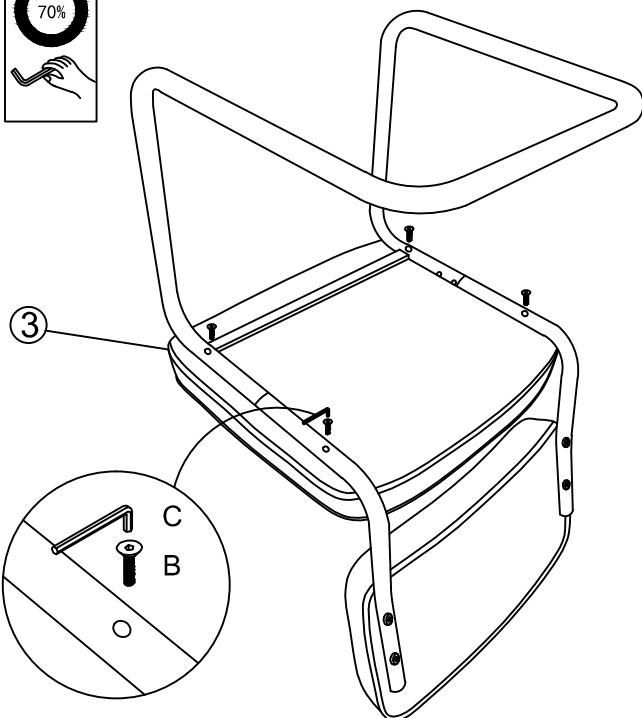
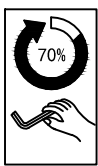

## STEP 3 Please tighten the 4 screws with 70%

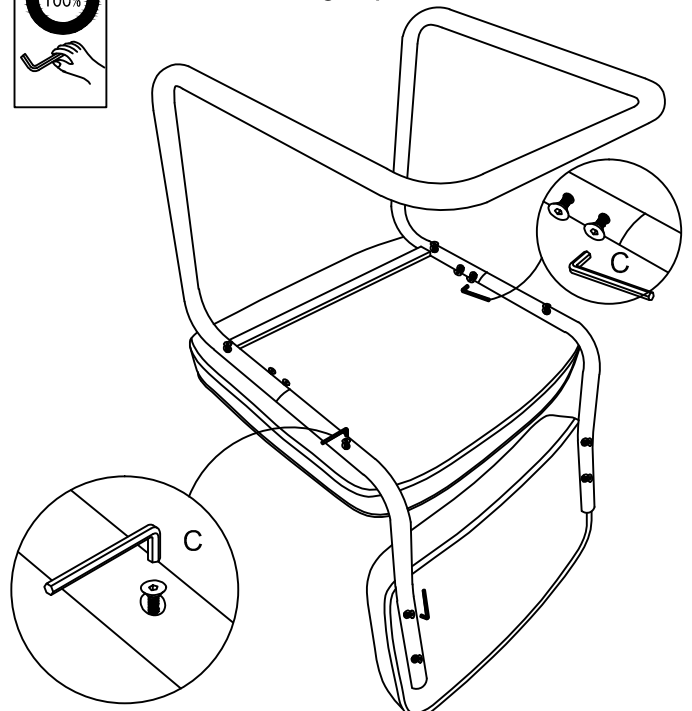

## STEP 4 Before you tighten all the screws down in 100%, please adjust the chair in stable and right position.

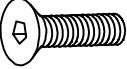

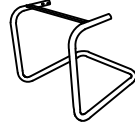
# ASSEMBLY INSTRUCTION

<b>A</b>  M6x13 x4	<b>B</b>  M6x40 x4	<b>C</b>  x1	<b>①</b>  x1	<b>②</b>  x1	<b>③</b>  x1
---	---	---	---	--	---

## STEP 5

