

BenQ



XL

MONITOR FOR  
e-SPORTS

XL Series  
Quick Start Guide

DN: Z-XL40K-EQ-V4

© 2020 BenQ Corporation. All rights reserved. Rights of modification reserved.

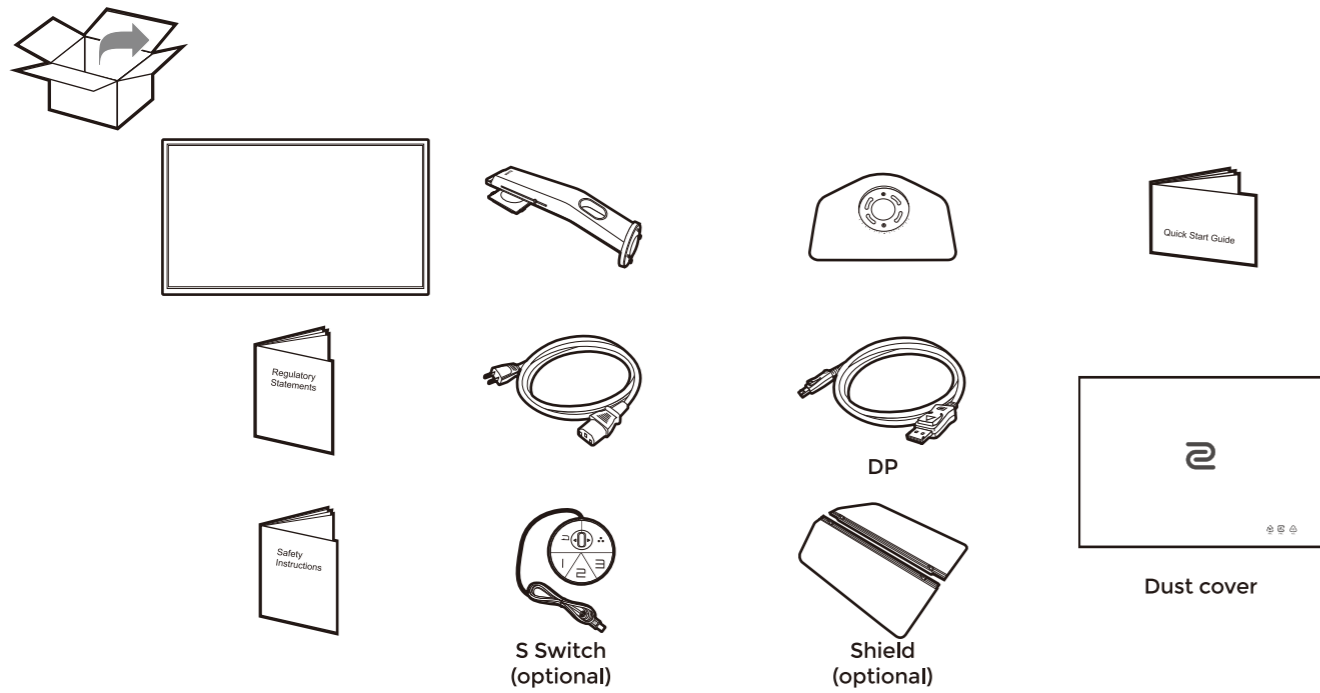
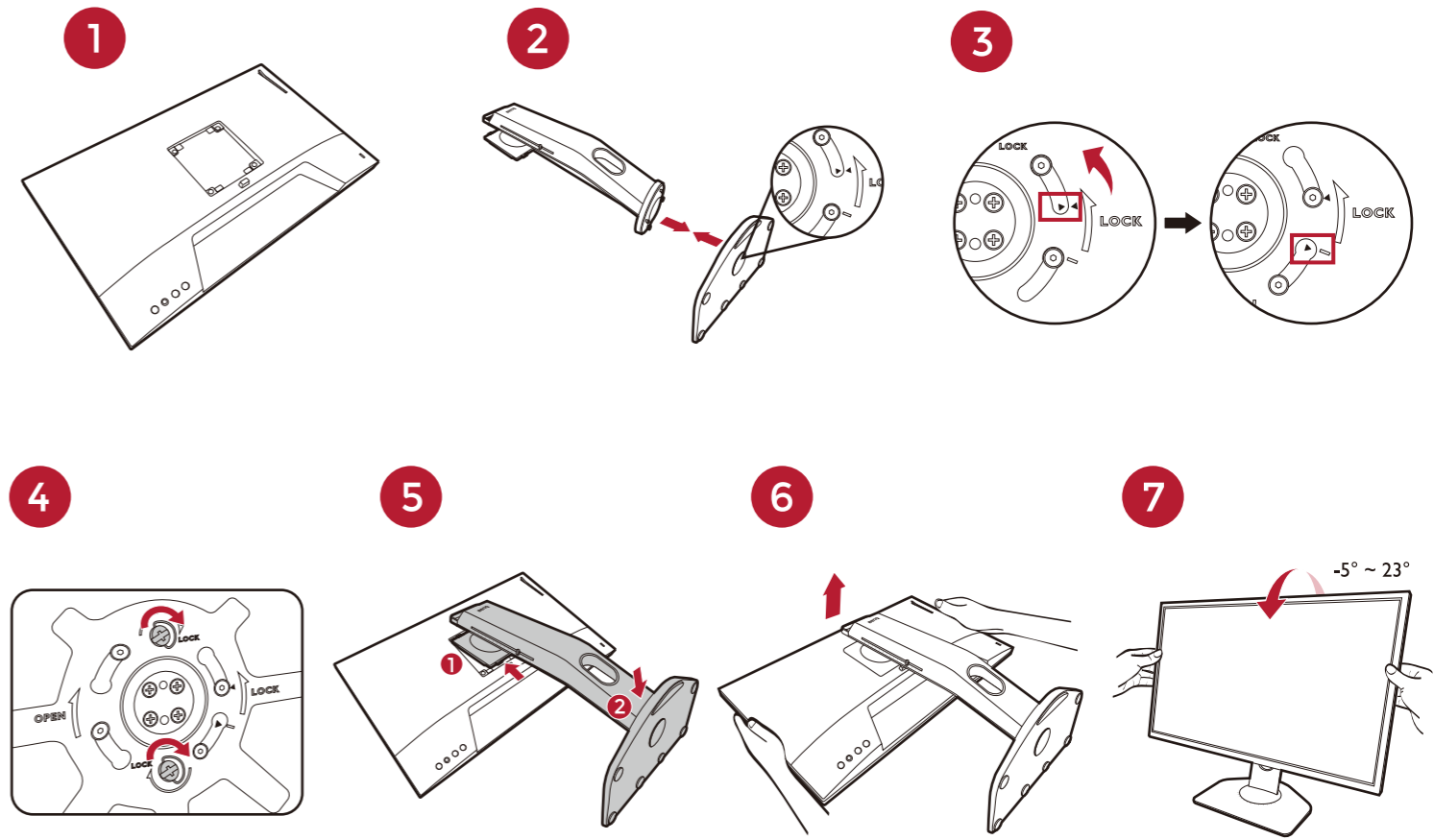

- 8 Video
- 9 Audio
- 10 S Switch (optional)

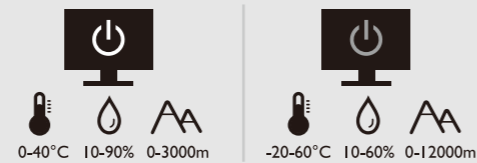
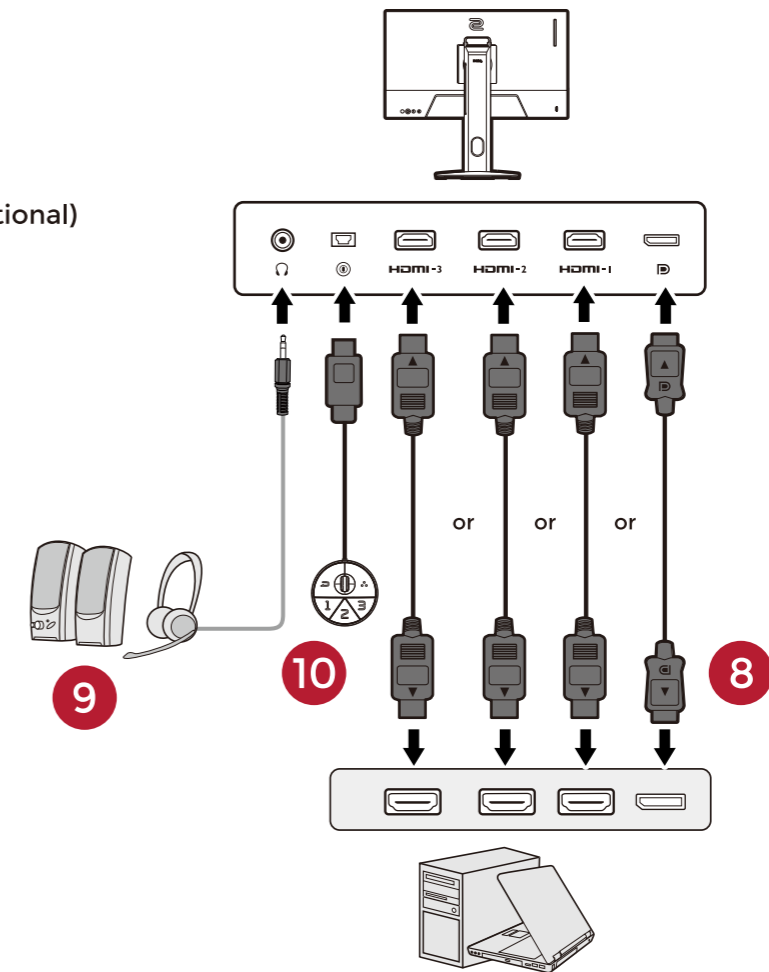

11

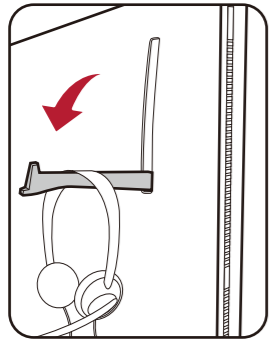

12

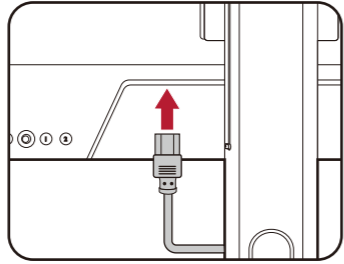

13

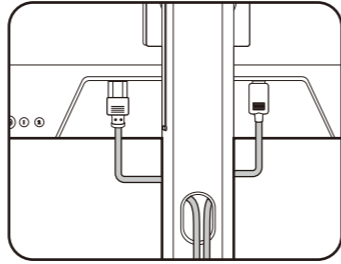

13

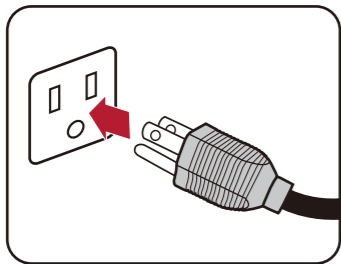

14

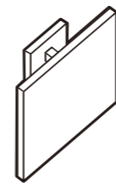
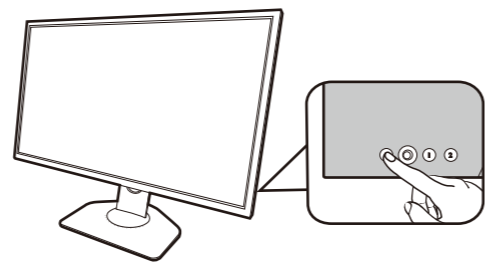

1

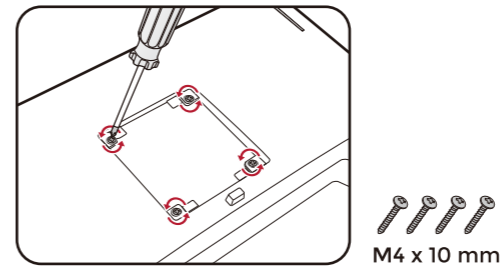

2

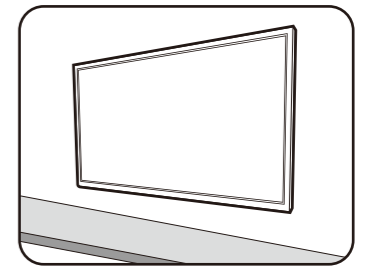

### Installing the Shield (optional step)

1

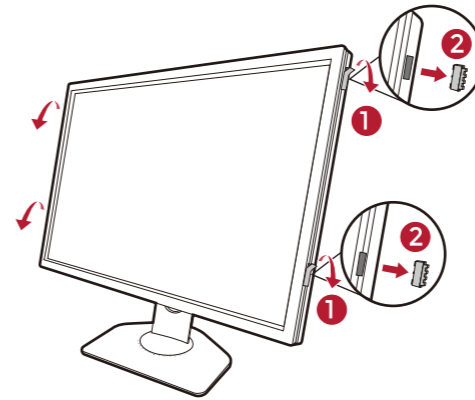

2

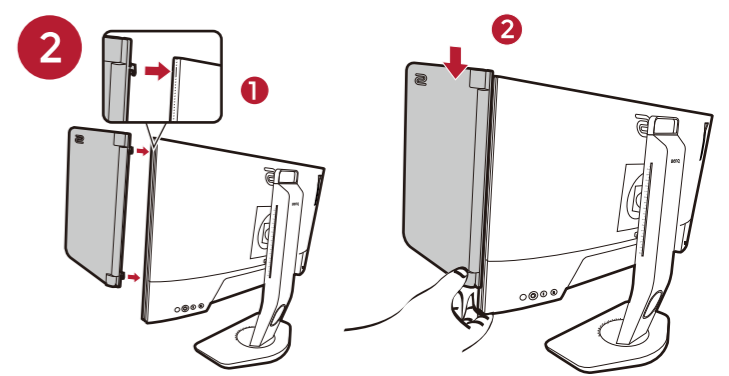

3

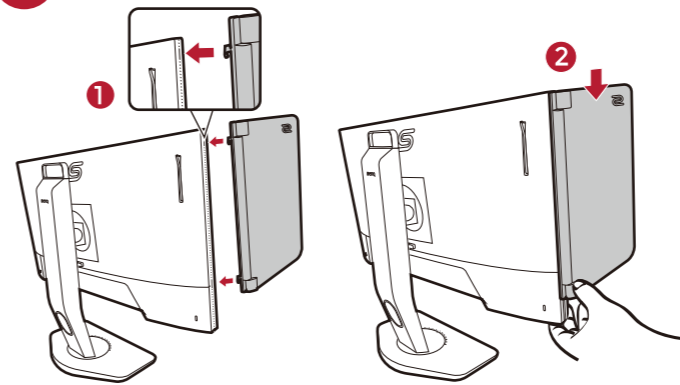

4

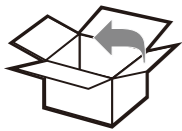
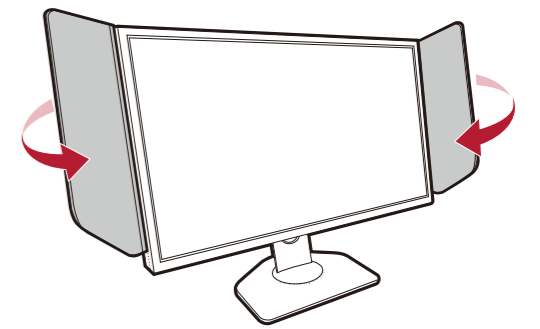

1

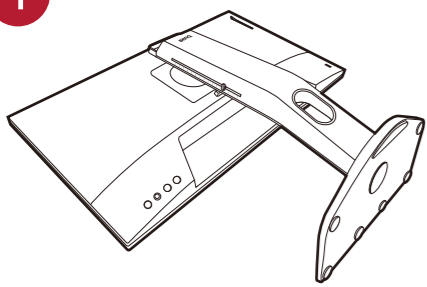

2

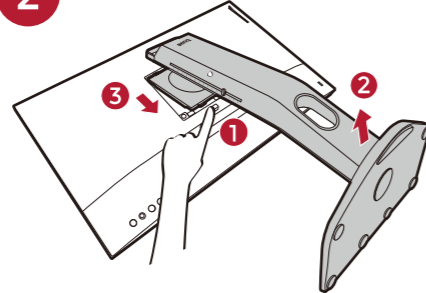

3

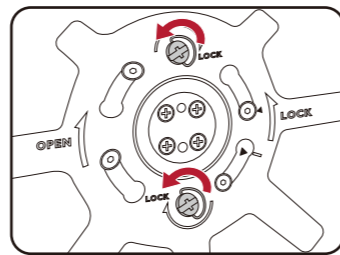

4

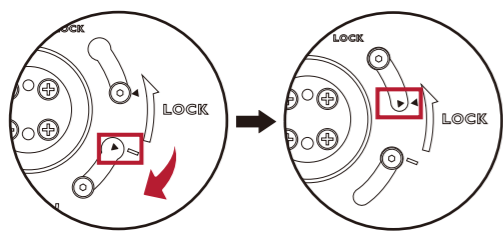

5

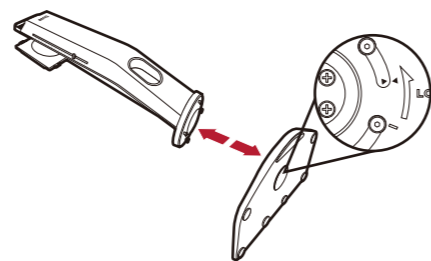

ZOWIE.BenQ.com > Support > Download & FAQ > Model name > Software

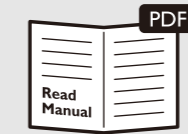

ZOWIE.BenQ.com > Support > Download & FAQ > Model name > User Manual



For product support and more information.