

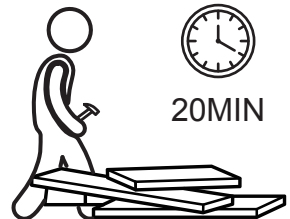

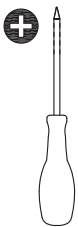

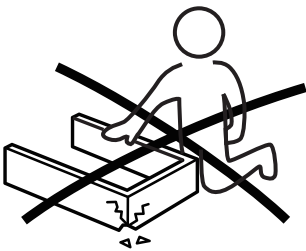

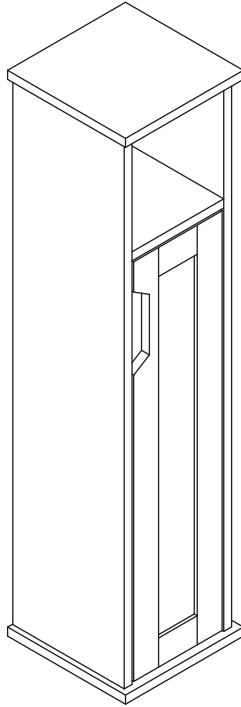

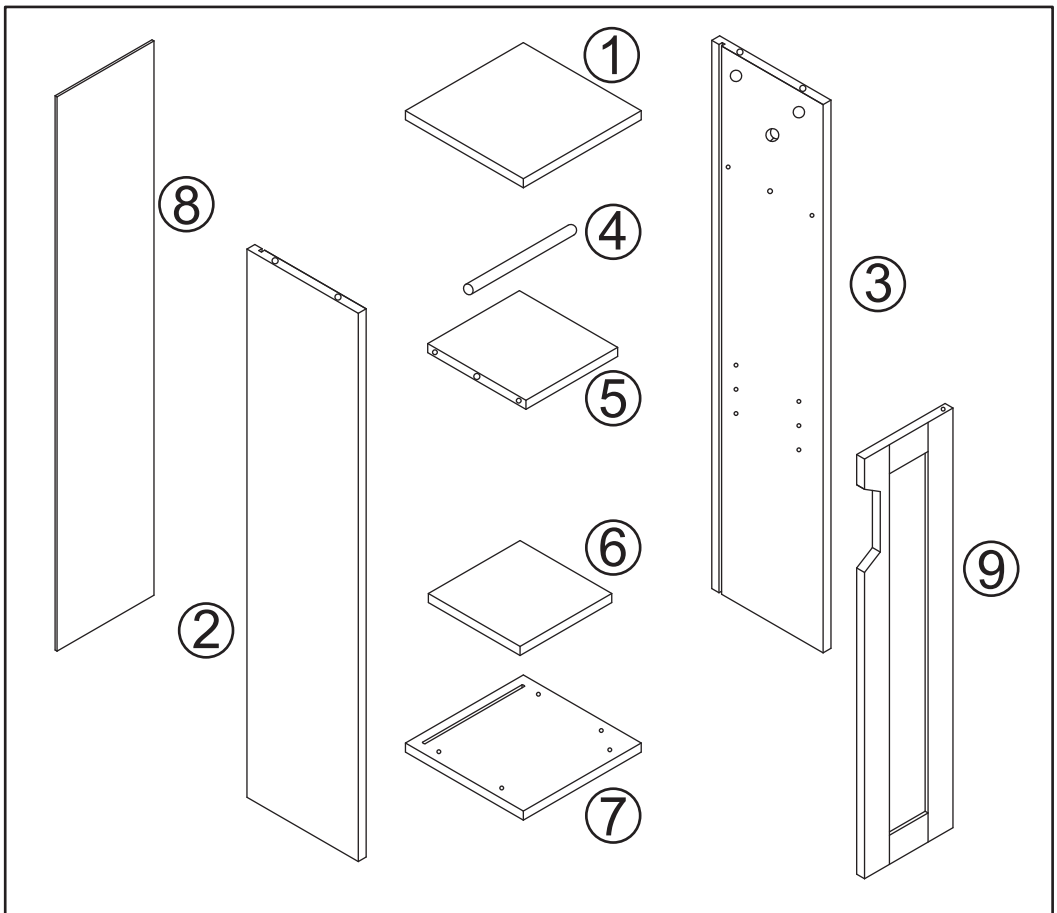
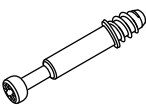

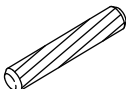
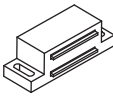

9912-195



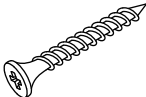

<p>Ax6</p>  <p>6x35mm</p>	<p>Bx6</p>  <p>15x10mm</p>	<p>Cx4</p>  <p>6x30mm</p>	<p>Dx1</p> 	<p>Ex6</p>  <p>3x14mm</p>
<p>Fx2</p> 	<p>Gx1</p>  <p>3x12mm</p>	<p>Hx1</p> 	<p>Ix4</p> 	<p>Jx4</p>  <p>4x35mm</p>
<p>Kx4</p> 	<p>Lx4</p> 	<p>Mx4</p> 		

1

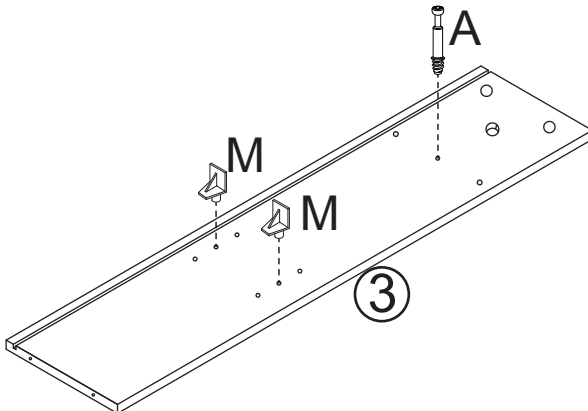
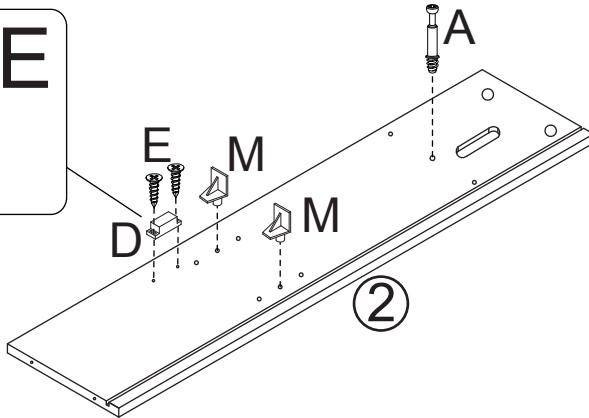
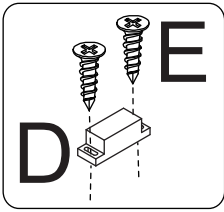
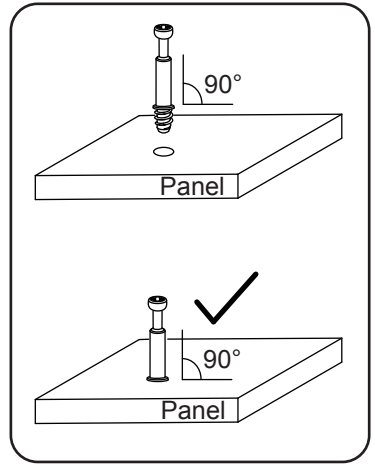
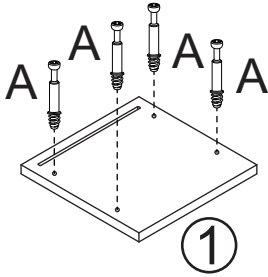

2

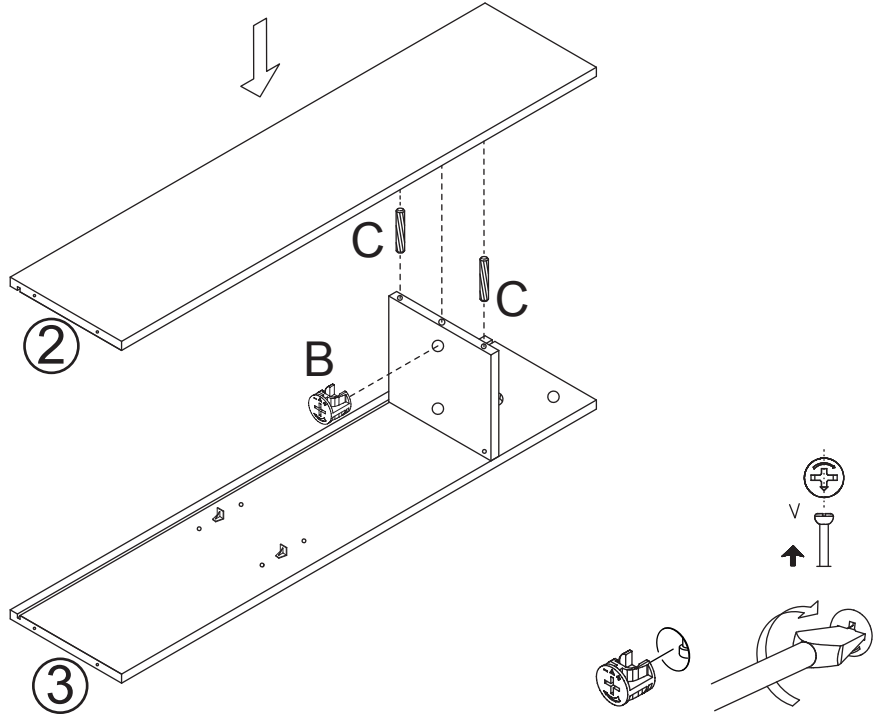
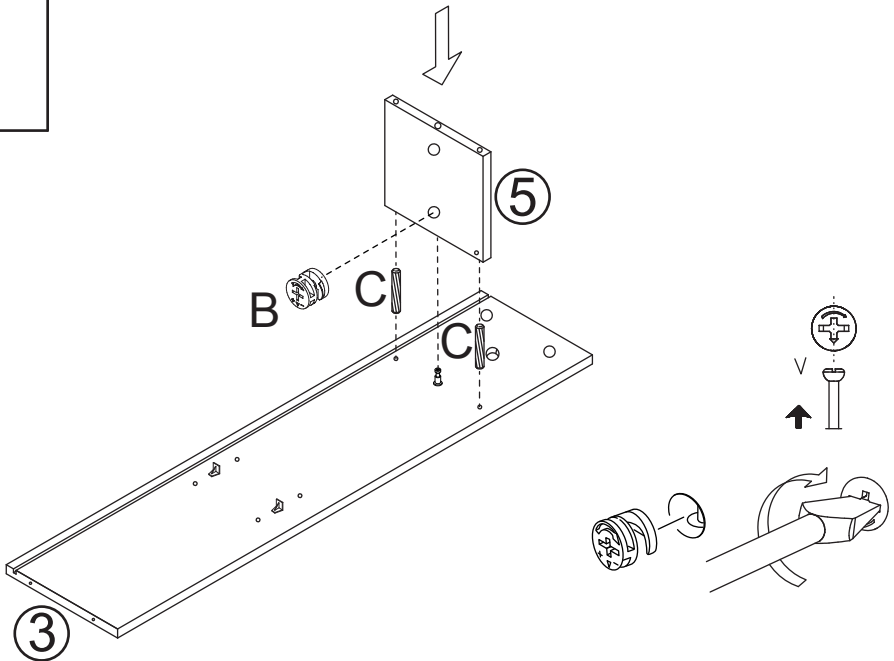

3

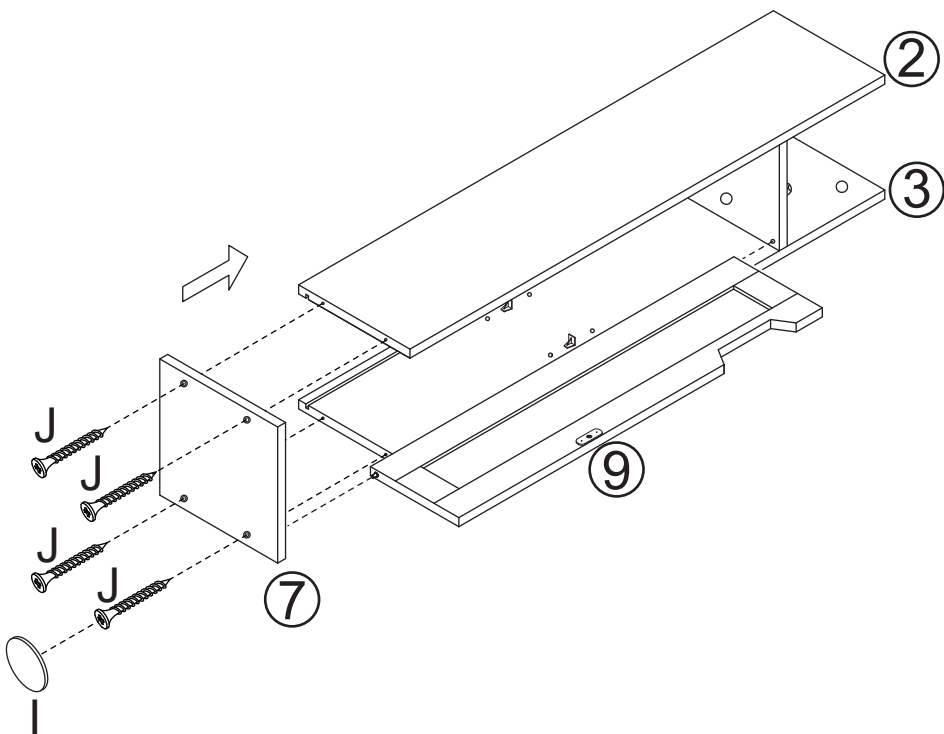
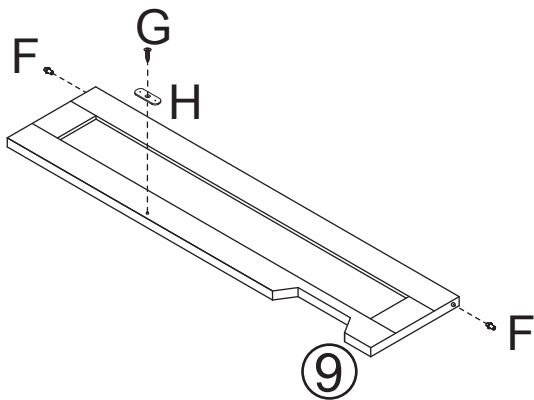

4

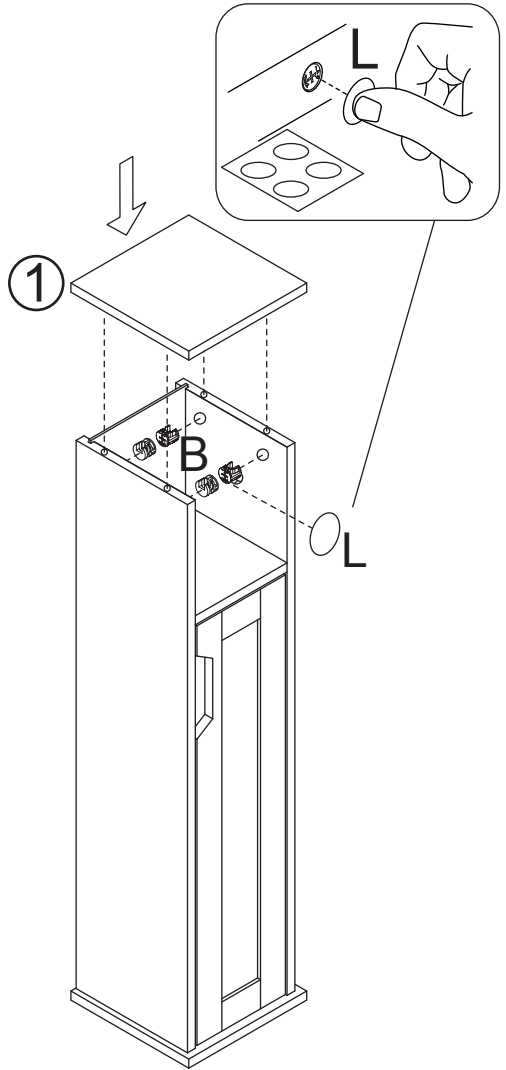
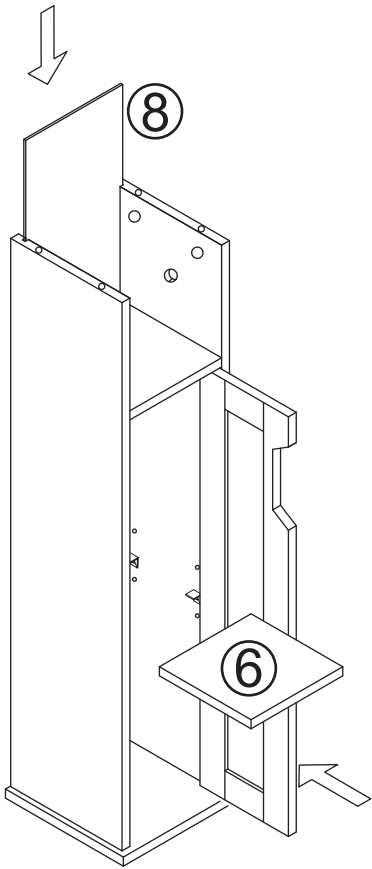

5

Avant de fixer "K",
s'assurer que la dimension "XX=YY".
Before fix "K",
please make sure size "XX=YY".

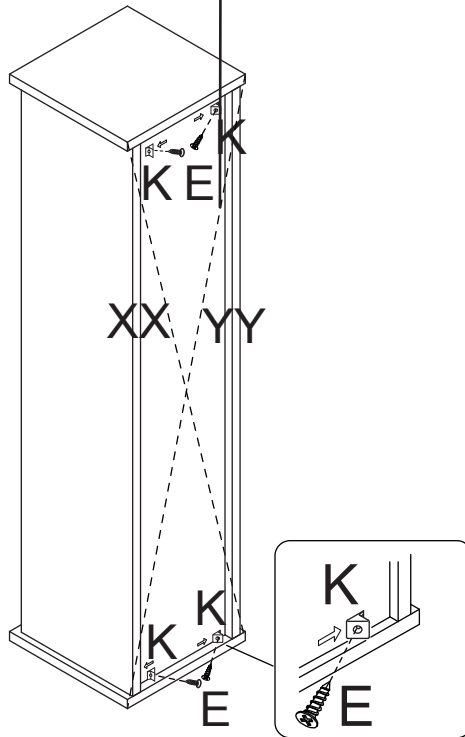

6

