

K'nex

IMAGINE™

POWER & PLAY
Motorized Building Set

SUPER BOX AVEC
MOTEUR

Jeu de construction
motorisé

50 BUILDS
MODÈLES*

MOTOR ⚡ **MOTEUR**^[1]

AA (LR6) AA (LR6)

Not Included/Pas Inclus^[2]

Ages

7-12

23012

⚠ WARNING:

CHOKING HAZARD – Toy contains a small ball and small parts. Not for children under 3 years.

⚠ ATTENTION :

RISQUE D'ÉTOUFFEMENT – Ce jouet contient une bille en plastique et des pièces de petite taille. Ne convient pas aux enfants de moins de 3 ans.

* Modelos
Modelle
Modelli
Modelo
Modellen

[1] Motore

[2] No se incluyen
Nicht enthalten
Non include
Não estão incluídas
Niet inbepenen



(EN) CONTENTS

HAMMER	4
WRENCH	5
MUSHROOMS.....	5
MONKEY & BANANA.....	6
SCORPION.....	7
TRI-WHEELER	8
CARTWHEELER.....	9
MUDFISH	10
FROG.....	12
FAN	14
TRACTOR	15
BI-PLANE	18
DRILL.....	20
BUS.....	22
JESTER.....	26
BASKETBALL GAME.....	30
BUILDING IDEAS.....	35

(FR) CONTENU

MARTEAU	4
CLÉ	5
CHAMPIGNONS	5
SINGE ET SA BANANE	6
SCORPION	7
TRICYCLE	8
CHARRIOT.....	9
POISSON	10
GRENOUILLE	12
VENTILATEUR.....	14
TRACTEUR.....	15
BIPLAN	18
FORET.....	20
AUTOBUS	22
FOU	26
JEU DE BASKET-BALL.....	30
IDÉES DE CONSTRUCTION	35

K'nex

Building Basics Bases de Construction

Start Building

Each K'NEX piece has its own shape and color. Try to position your model in the same direction as the instructions. Faded colors show you this section is already built.

Démarre ta Construction

Chaque K'NEX pièce a sa propre forme et sa propre couleur. Pour te faciliter la tâche, oriente le modèle dans le même sens que les instructions. Les pièces ayant une couleur estompée sont celles déjà assemblées.

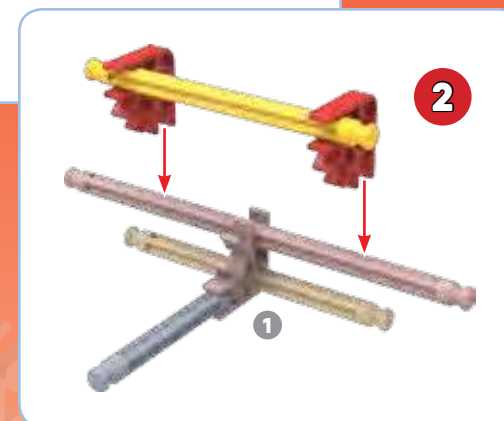
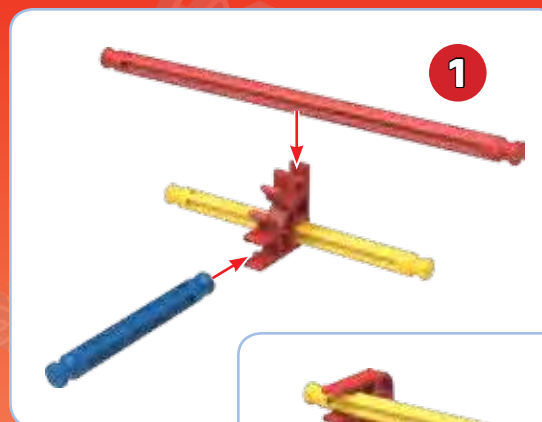

Connectors

Push these special connectors together tightly until you hear a "click".

Connecteurs

Pousse connecteurs spéciaux fort jusqu'à entendre un « clic ».

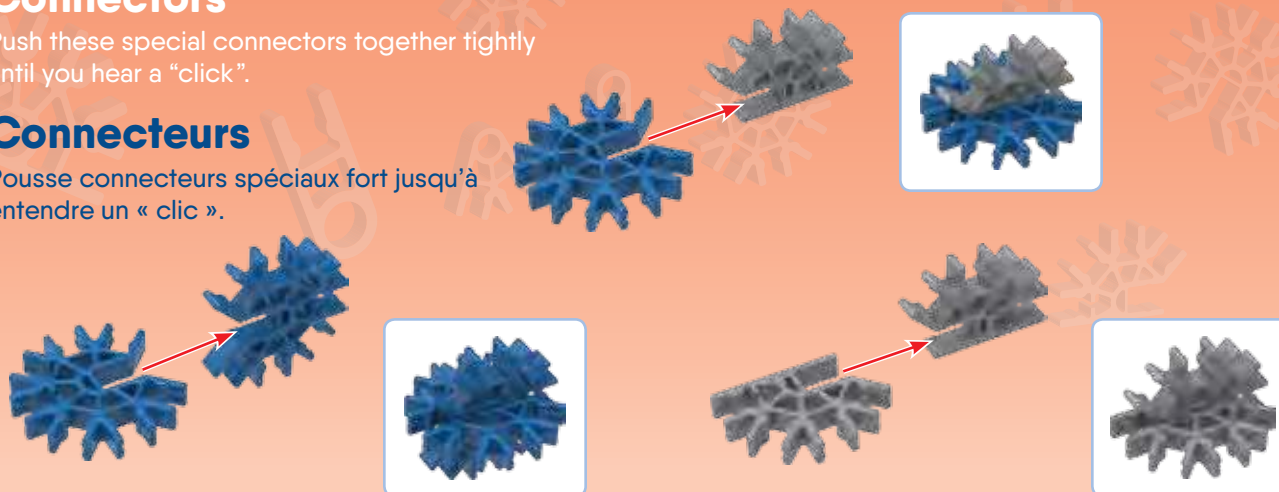

Spacers

Be sure to use the correct color and number of spacers shown.

Séparateurs

Assure-toi d'utiliser la bonne nombre de séparateurs.



Battery Information

How to Insert and Remove Batteries

Use a small Phillips head screwdriver to loosen the screw. Insert 2 fresh AA (LR6) batteries [not included] into the compartment with the correct polarity (+/-) as shown here.

Install batteries before building models.

CAUTION: To Avoid Battery Leakage

- Insert batteries with correct polarity (+/-) as shown.
- Do not mix different types of batteries.
- Do not mix alkaline, standard (carbon-zinc) or rechargeable (nickel-cadmium) batteries.
- Do not mix new and used batteries. Only batteries of the same or equivalent type recommended should be used.
- Remove exhausted batteries from the toy; do not short-circuit supply terminals.
- Remove all batteries if the toy will not be used for a long period of time.

Important Tips

- Alkaline batteries are recommended.
- Rechargeable batteries are not recommended.
- Remove rechargeable batteries before recharging; they must be charged only under adult supervision.
- Non-rechargeable batteries must not be recharged.
- Keep components free of dust; do not immerse or use in water.
- Do not dispose of batteries in a fire; they could leak or explode and cause injury.



The wheelie bin indicates this product cannot be disposed of with household waste due to presence of hazardous substances.

To protect human health and environment, check your local authority for recycling advice and facilities (2012/19/EU, Europe only).



Informations sur les Piles

Comment mettre et retirer des piles

Utiliser un petit tournevis pour desserrer la vis et pour enlever le couvercle des piles. Insérer 2 piles AA (LR6) [pas inclus] neuves dans le compartiment en respectant la polarité (+/-).

Installe les piles avant de réaliser tes constructions.

ATTENTION : Pour éviter la fuite des piles

- Insérez les piles en respectant la polarité (+/-) comme indiqué.
- Ne pas mélanger différents types de piles.
- Ne pas mélanger des piles alcalines avec des piles standard (carbone-zinc), ou des piles rechargeables (au nickel-cadmium).
- Ne pas mélanger des piles neuves avec des piles usées. Il convient d'utiliser uniquement des piles du type recommandé ou d'un type équivalent.
- Retirer toujours les piles faibles ou mortes du produit ; ne pas faire court-circuiter les terminaux.
- Retirez toutes les piles si le jouet ne sera pas utilisé pendant une longue période de temps.

Conseils Importants

- Les piles alcalines sont recommandées.
- Les piles rechargeables ne sont pas recommandées.
- Retirer les piles rechargeables du jouet avant de les recharger; elles doivent être chargées exclusivement en présence d'un adulte.
- Les piles qui ne sont pas rechargeables ne doivent pas être rechargées.
- Veiller à ce que les éléments restent à l'abri de la poussière ; ne pas les plonger ni les utiliser dans l'eau.
- Ne pas jeter les piles dans le feu ; elles risqueraient de fuir ou d'exploser et d'entraîner des blessures.

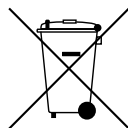

Le symbole "poubelle à roulettes" indique que ce produit ne peut pas être éliminé avec vos déchets ménagers en raison de la présence de substances dangereuses.

Afin de protéger votre santé et l'environnement, renseignez-vous auprès de vos autorités locales afin d'obtenir des conseils sur le recyclage et la localisation des installations adaptées (2012/19/EU, Europe uniquement).

Parts List

Be sure to compare the parts in your set with the parts list here. If anything is missing, call or write to us using the information on the back cover. We are here to help you!

Liste des Pièces

Assure-toi de comparer les pièces dans ta boîte à la liste de pièces fournie ici. S'il manque quelque chose, téléphone-nous ou écris-nous en te servant des informations figurant au verso de la notice. Nous sommes là pour t'aider !



WARNING: CHOKING HAZARD – Toy contains a small ball and small parts. Not for children under 3 years.

ATTENTION : RISQUE D'ÉTOUFFEMENT – Ce jouet contient une bille en plastique et des pièces de petite taille. Ne convient pas aux enfants de moins de 3 ans.

ADVERTENCIA: PELIGRO DE ASFIXIA – Juguete contiene una pequeña bola y piezas pequeñas. No recomendado para niños menores de 3 años.

ACHTUNG: ERSTICKUNGSGEFAHR – Spielzeug enthält einen kleinen Ball und Kleinteile. Nicht für Kinder unter 3 Jahren.

AVVISO: PERICOLO DI SOFFOCARE – Giocattolo ha una pallina piccola e pezzi piccoli. Non adatto per bambini sotto 3 anni.

AVISO: PERIGO DE SUFOCAÇÃO – Toy contém uma pequena bola e peças pequenas. Não indicado para crianças menores de 3 anos.

WAARSCHUWING: INSLIKKINGSGEVAAR – Dit speelgoed bevat een balletje en kleine onderdelen. Niet geschikt voor kinderen jonger dan 3 jaar.

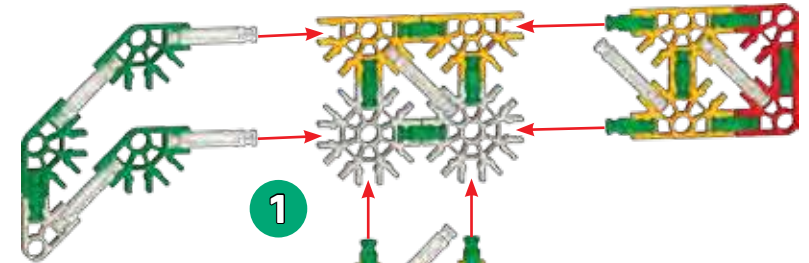

HAMMER MARTEAU



2



CAUTION: Keep hands, face, hair and clothing away from all moving parts.

ATTENTION : Garde les cheveux, les doigts, la figure et les vêtements à l'écart de toutes les pièces mobiles.

PRECAUCIÓN: Mantén el cabello, los dedos, la cara y la ropa alejada de las piezas móviles.

VORSICHT: Haare, Finger, Gesicht und Kleidungsstücke nicht mit beweglichen Teilen in Berührung kommen lassen.

ATTENZIONE: Tenere i capelli, le dita, il viso e i vestiti lontano da tutte le parti in movimento.

CUIDADO: Mantém o cabelo, os dedos, a cara e a roupa afastados de todas as peças móveis.

LET OP: Hou het haar, de vingers, het gezicht en kledij verwijderd van alle bewegende onderdelen.

WRENCH CLÉ

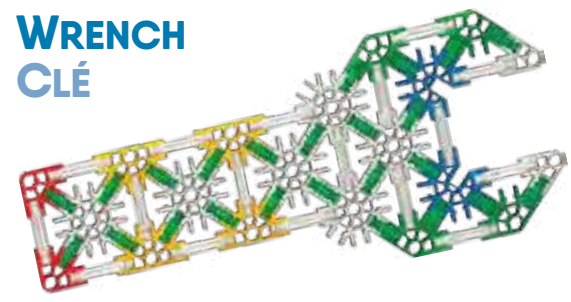

24		17		2	
2		2		2	
4		4		6	

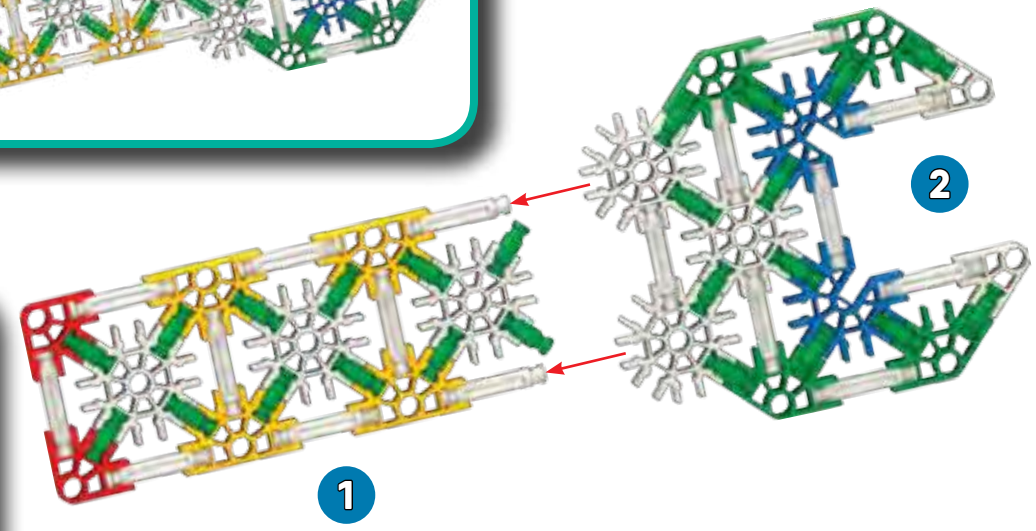

MUSHROOMS CHAMPIGNONS

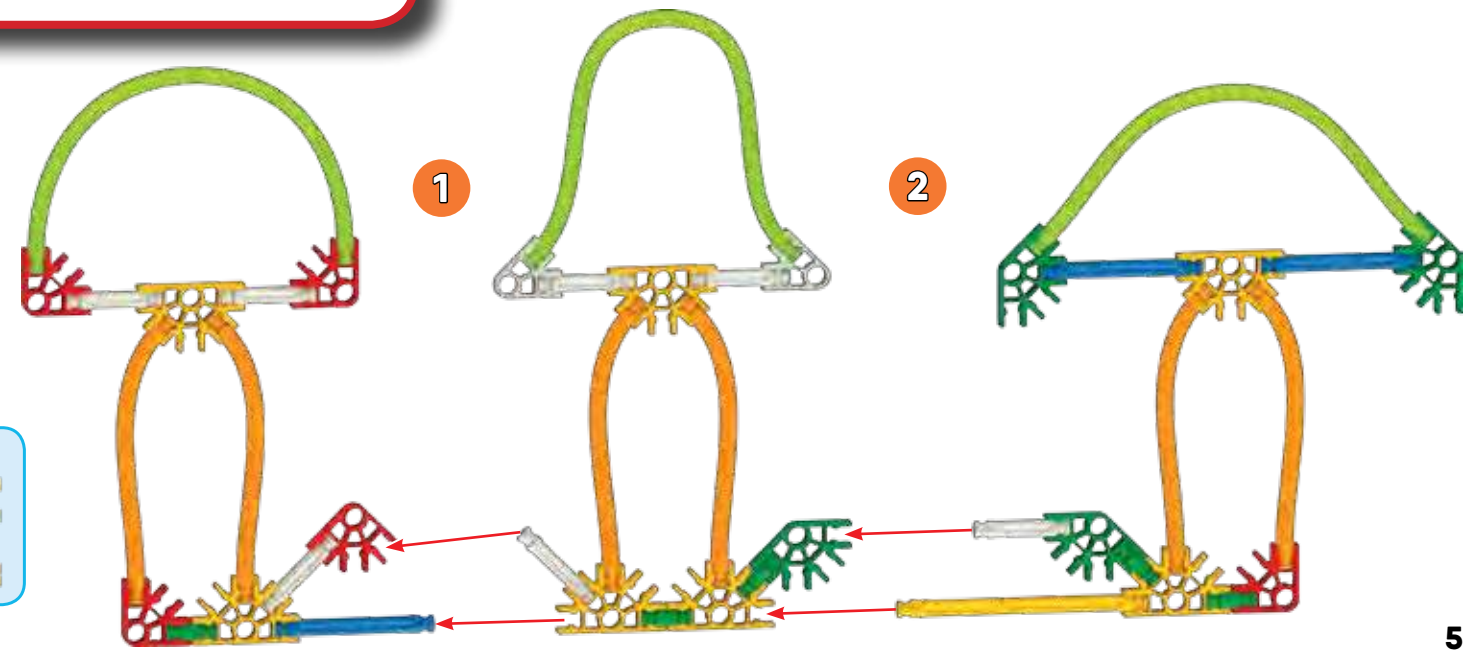
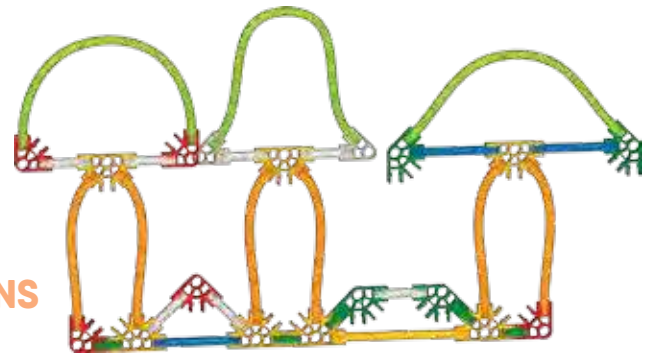

5		7		3	
6		1			
3					
2		5		4	
				7	

MONKEY & BANANA

SINGE ET SA BANANE



- | | | |
|----|----|---|
| 19 | 14 | 2 |
| 1 | | |
| 2 | 6 | 4 |
| 6 | 2 | 2 |

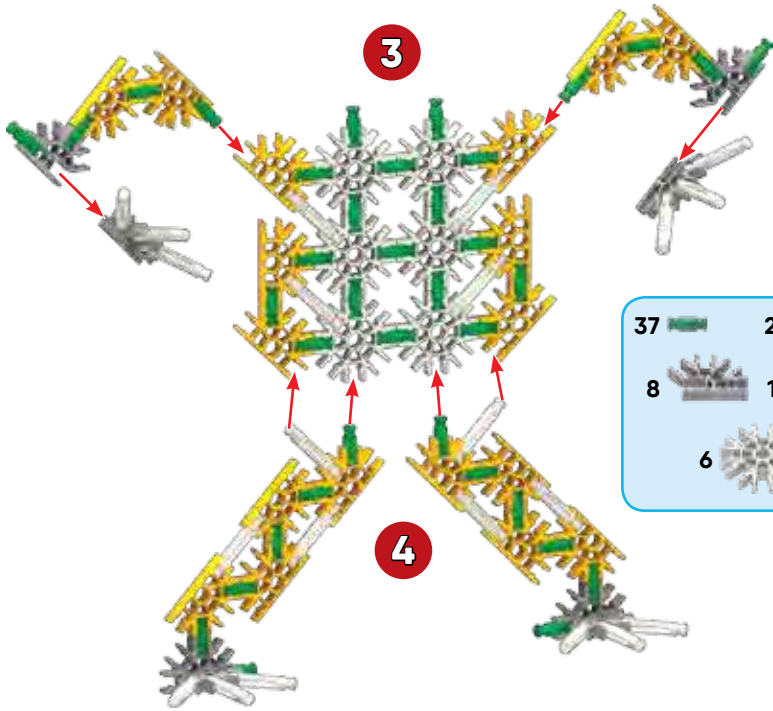
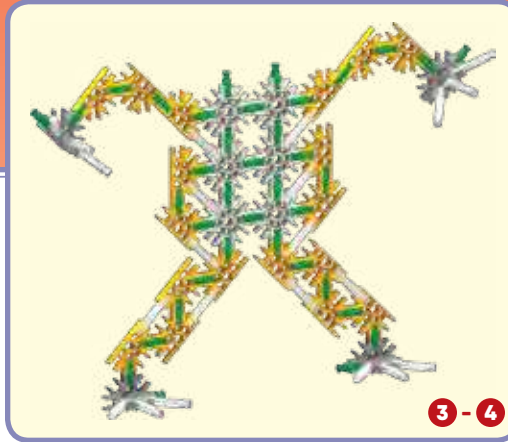
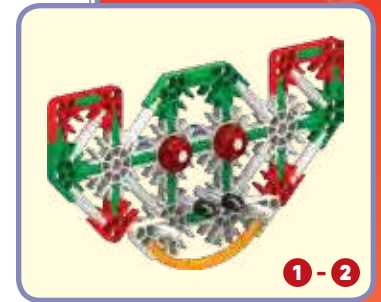
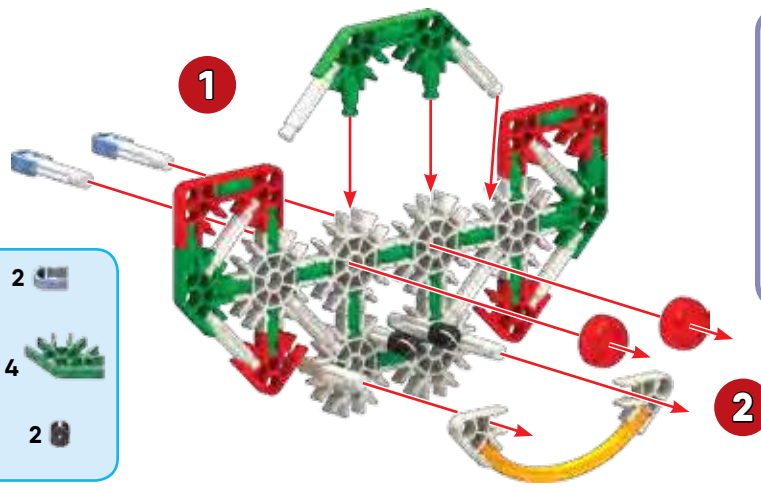

- | | |
|----|----|
| 37 | 22 |
| 8 | 18 |
| 6 | |

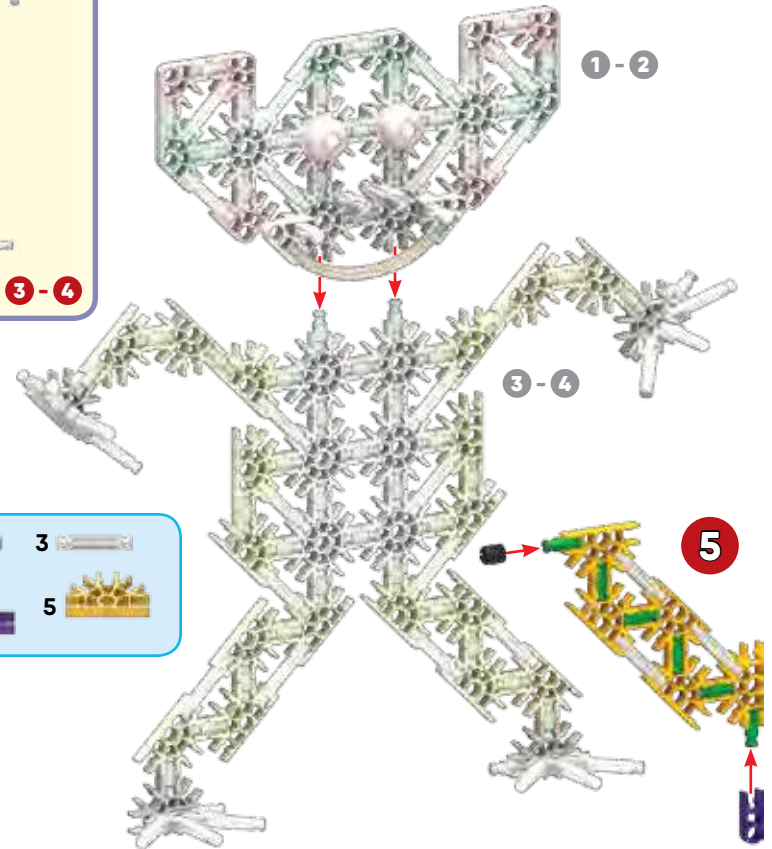

- | | |
|---|---|
| 6 | 3 |
| 1 | 5 |
| 1 | |

SCORPION SCORPION

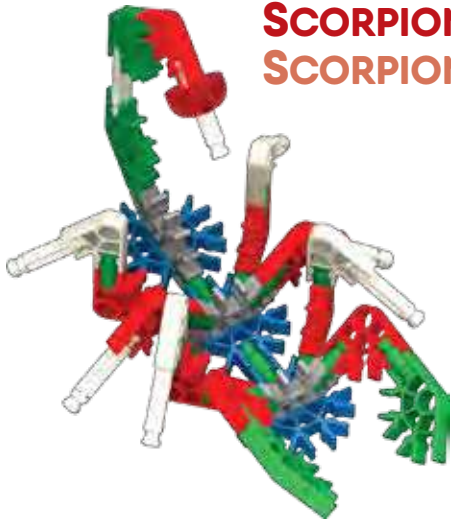

2

- | | | |
|----|---|---|
| 12 | 6 | 1 |
| 4 | 5 | 2 |
| 1 | 2 | |

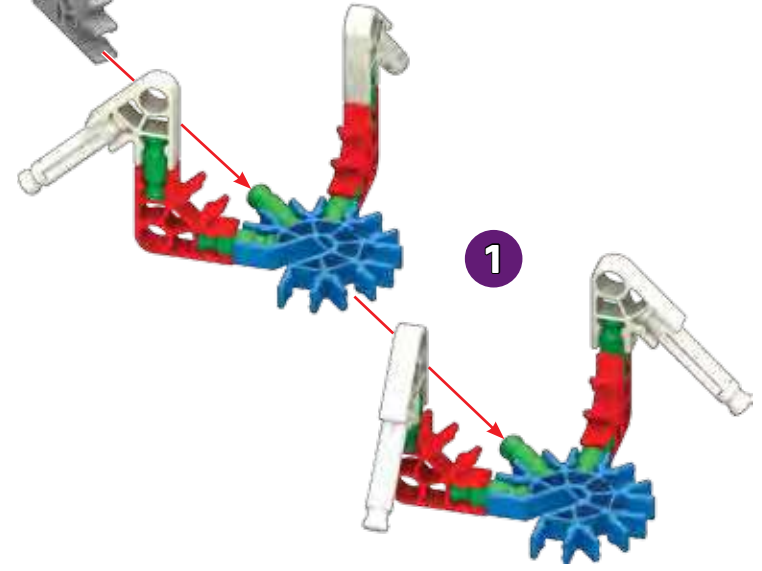

1

- | | |
|---|---|
| 6 | 2 |
| 4 | 2 |
| 2 | 1 |

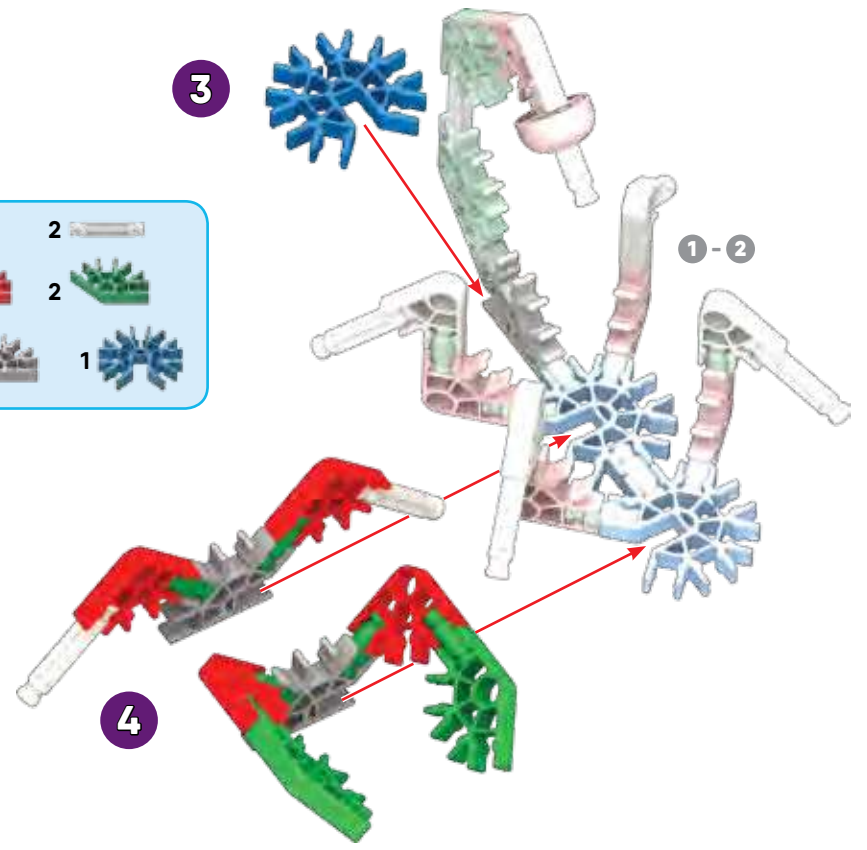

3

4

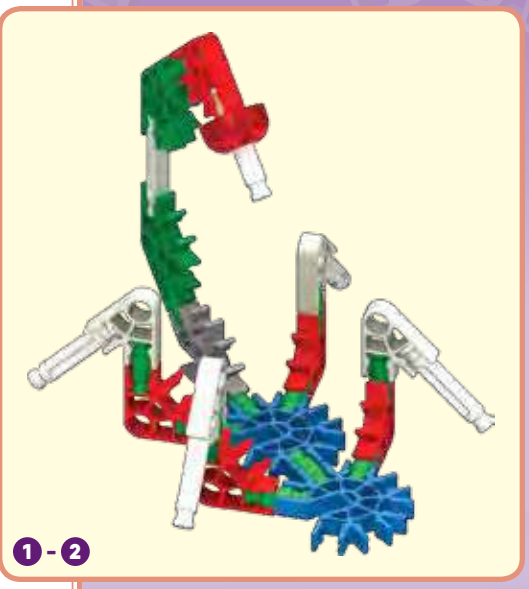

1-2

TRI-WHEELER TRICYCLE

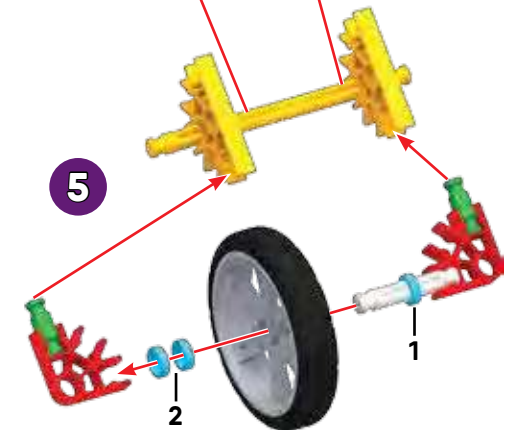
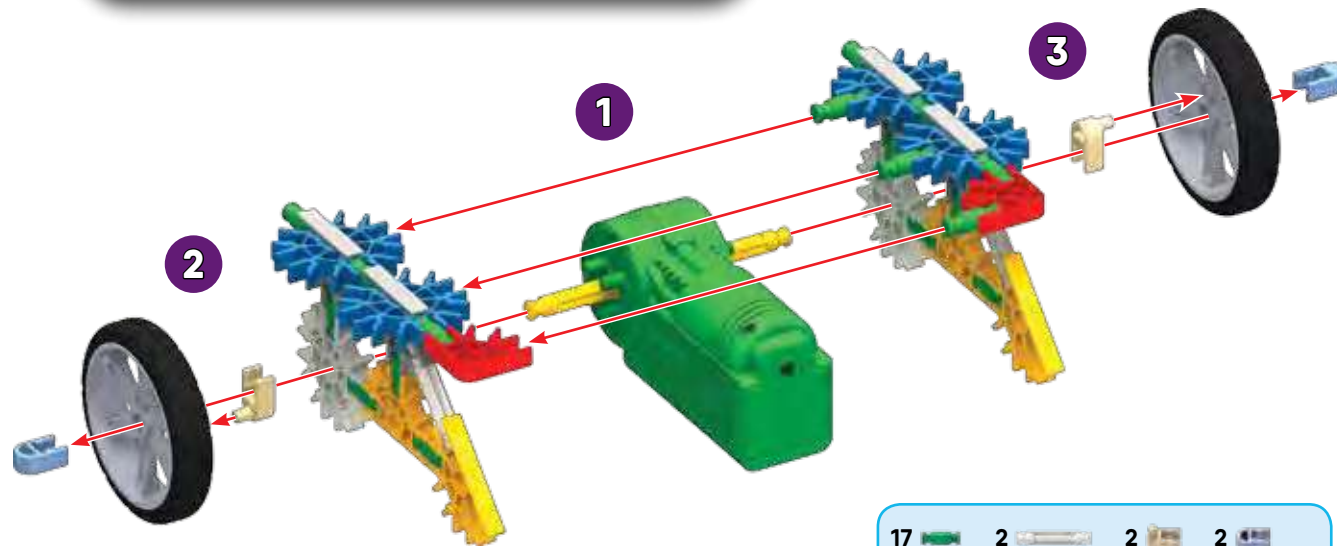
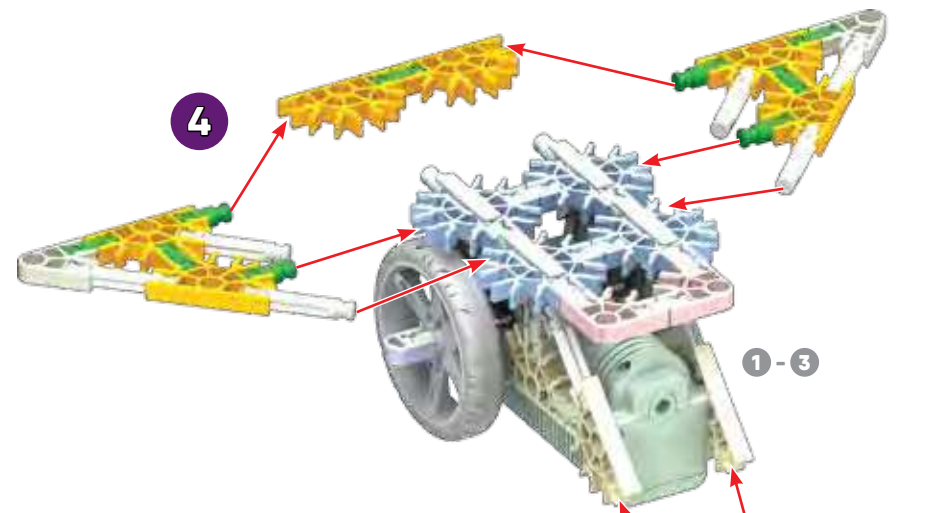

(EN) Did you install 2 AA (or LR6) batteries in the motor?
 (FR) Avez-vous installé 2 piles AA (ou LR6) ?
 (ES) ¿Instalaste 2 pilas AA (o LR6) en el motor?
 (DE) Hast du 2 AA (oder LR6) Batterien in den Motor eingelegt?
 (IT) Hai installato 2 batterie AA (o LR6) nel motore?
 (PT) Foram instaladas as pilhas 2 AA (ou LR6) no motor?
 (NL) Heb je 2 AA (of LR6)-batterijen in de motor geplaatst?

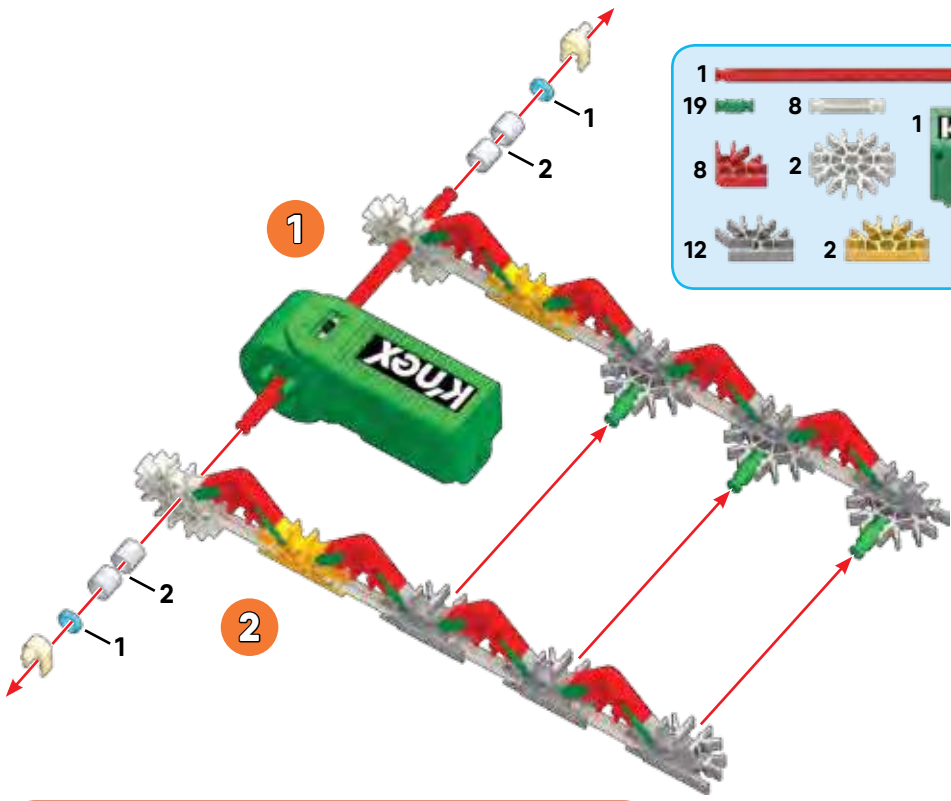

- | | | | | | | | |
|----|----|---|---|---|---|---|---|
| 1 | 19 | 8 | 8 | 2 | 1 | 2 | 4 |
| 12 | 2 | 2 | 2 | 2 | 1 | 2 | 2 |

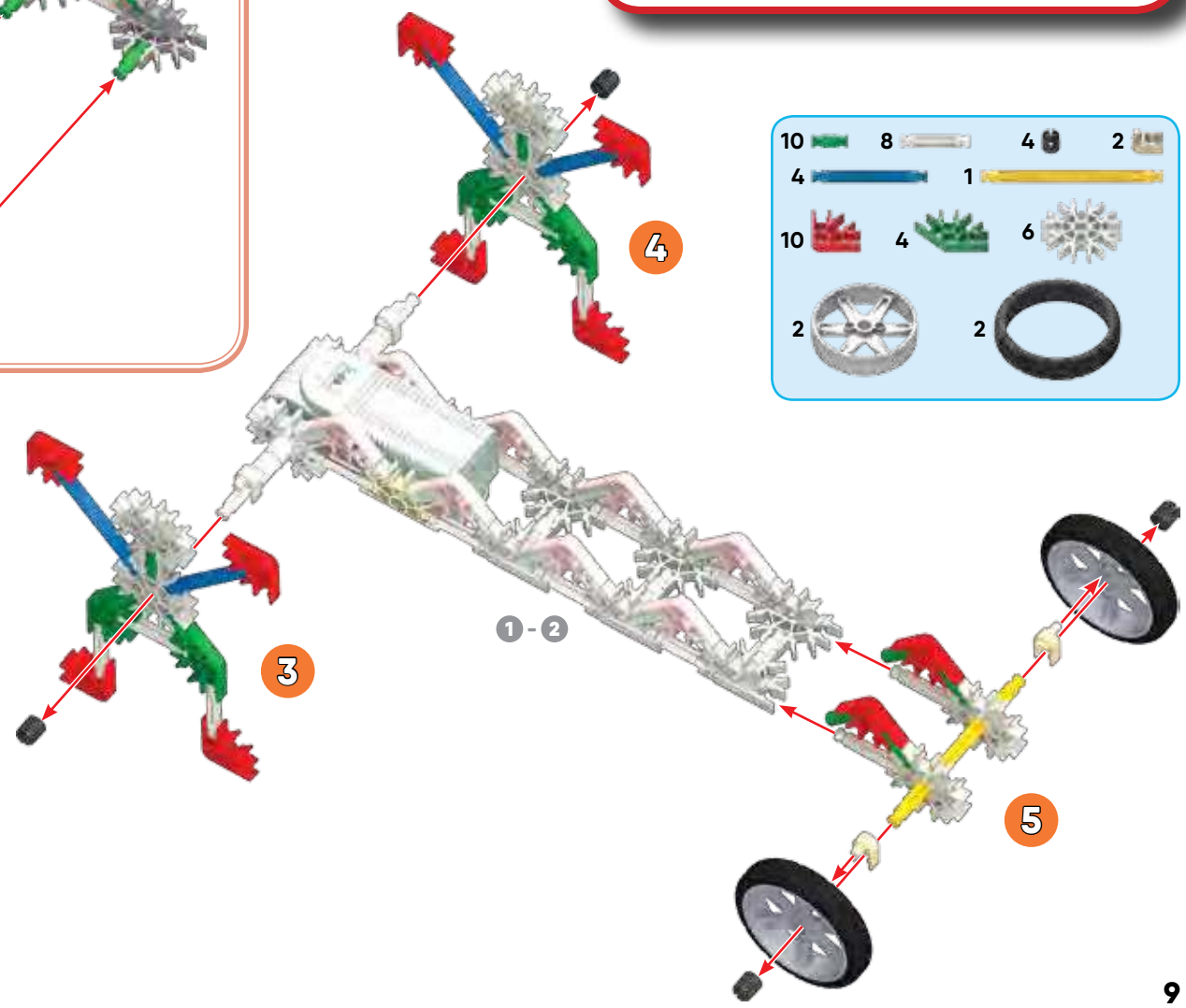
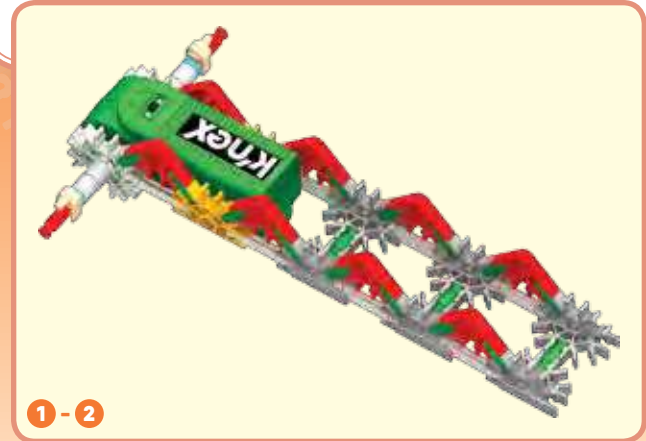

- | | | | |
|----|---|---|---|
| 10 | 8 | 4 | 2 |
| 4 | 1 | 1 | 1 |
| 10 | 4 | 6 | 6 |
| 2 | 2 | 2 | 2 |

(EN) Did you install 2 AA (or LR6) batteries in the motor?
 (FR) Avez-vous installé 2 piles AA (ou LR6) ?
 (ES) ¿Instalaste 2 pilas AA (o LR6) en el motor?
 (DE) Hast du 2 AA (oder LR6) Batterien in den Motor eingelegt?
 (IT) Hai installato 2 batterie AA (o LR6) nel motore?
 (PT) Foram instaladas as pilhas 2 AA (ou LR6) no motor?
 (NL) Heb je 2 AA (of LR6)-batterijen in de motor geplaatst?

MUDFISH POISSON

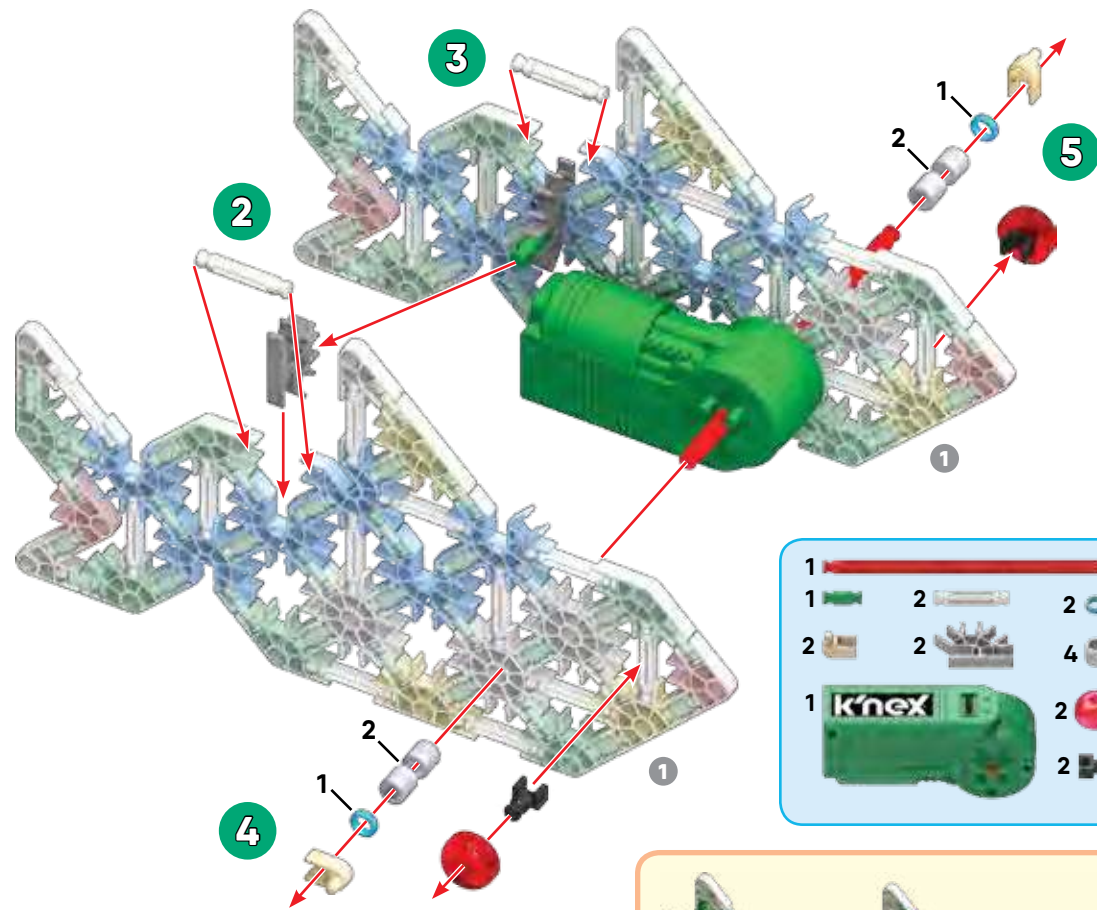
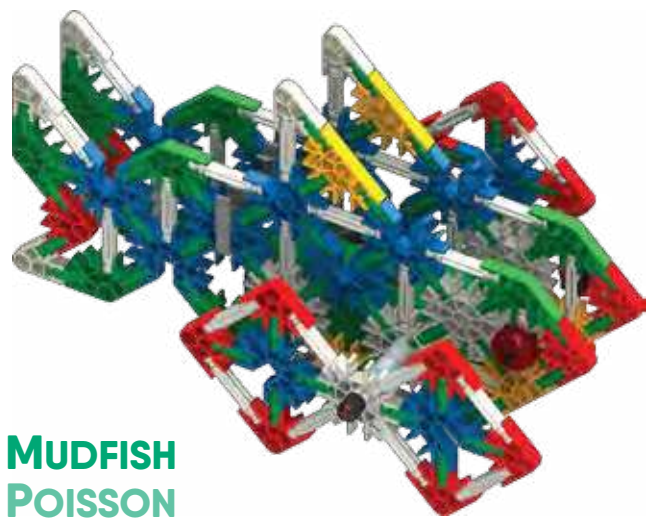

- | | | | | | |
|---|--|---|--|---|--|
| 1 | | 2 | | 2 | |
| 1 | | 2 | | 4 | |
| 2 | | 2 | | 2 | |
| 1 | | 2 | | 2 | |

x2

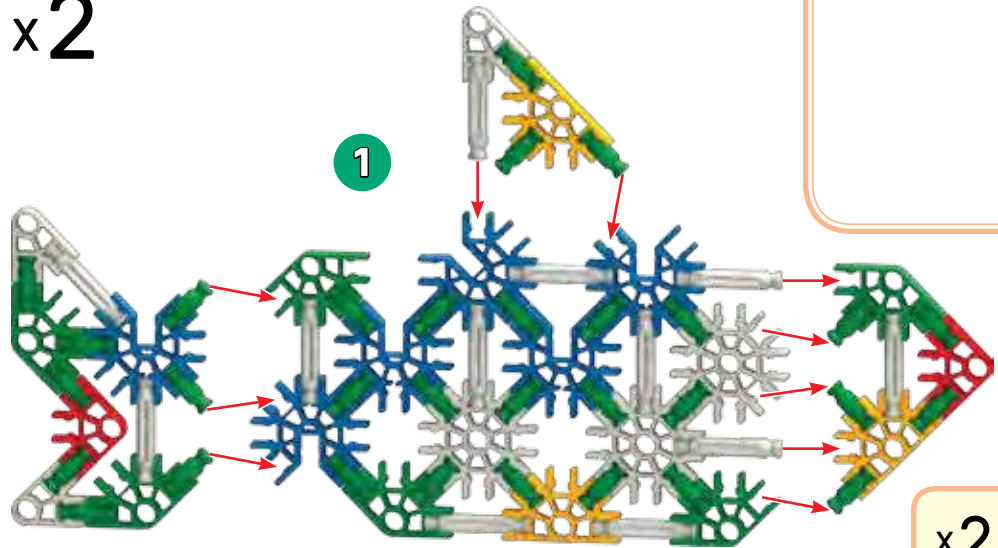

- | | | | | | |
|----|--|----|--|----|--|
| 62 | | 24 | | 6 | |
| 6 | | 4 | | 12 | |
| 12 | | 6 | | | |

x2

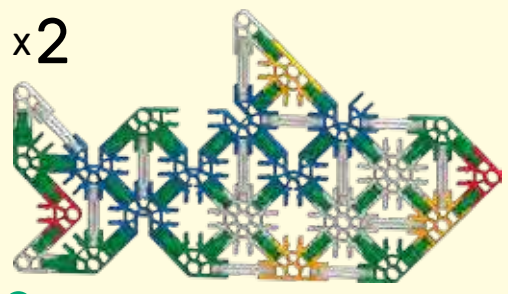

- (EN) Did you install 2 AA (or LR6) batteries in the motor?
- (FR) Avez-vous installé 2 piles AA (ou LR6) ?
- (ES) ¿Instalaste 2 pilas AA (o LR6) en el motor?
- (DE) Hast du 2 AA (oder LR6) Batterien in den Motor eingelegt?
- (IT) Hai installato 2 batterie AA (o LR6) nel motore?
- (PT) Foram instaladas as pilhas 2 AA (ou LR6) no motor?
- (NL) Heb je 2 AA (of LR6)-batterijen in de motor geplaatst?

x2

- 16 
- 16 
- 4 
- 2 
- 12 

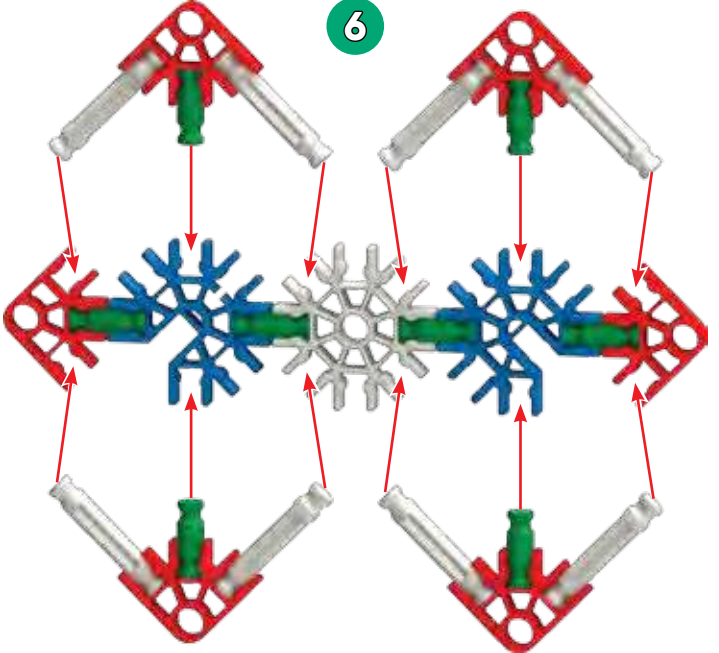

6

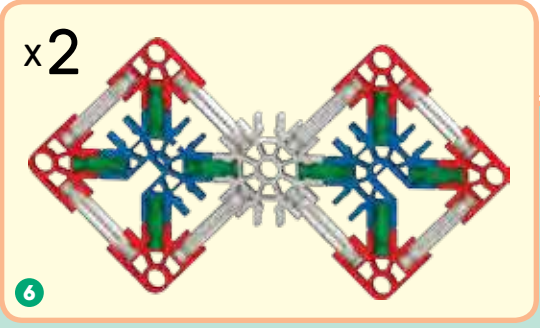

x2

6

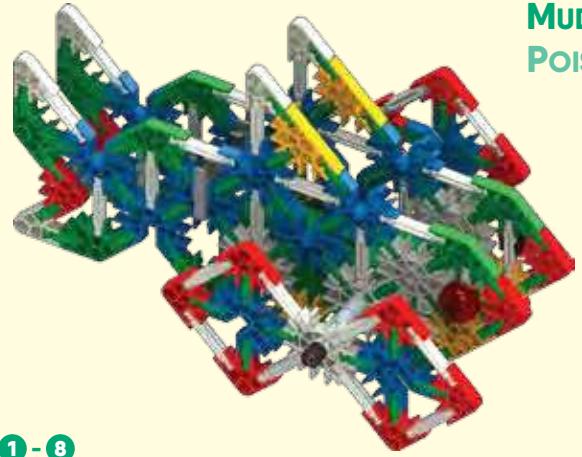

MUDFISH
POISSON

1-8

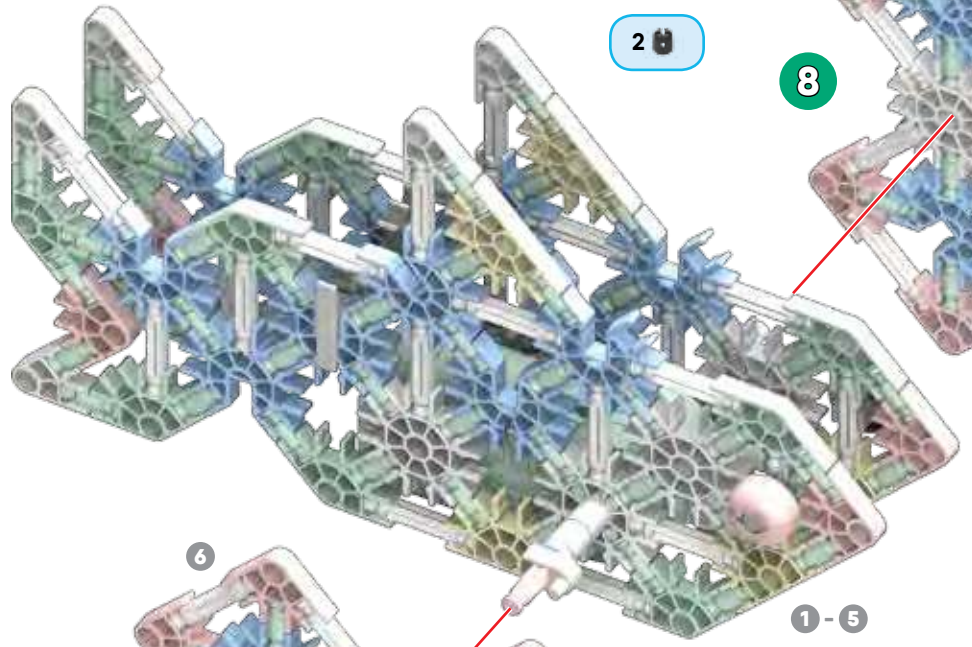

2

8

1-5

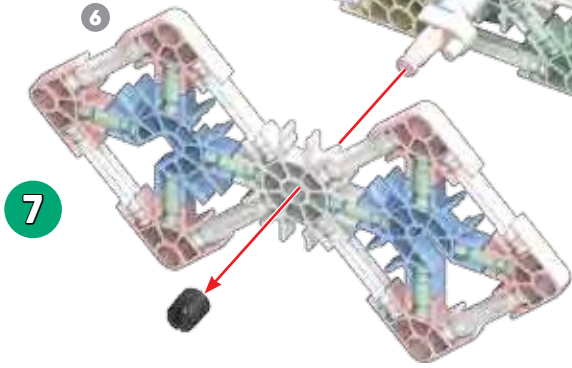

7

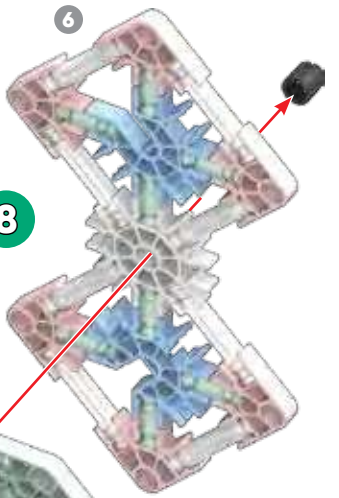

6

FROG GRENOUILLE

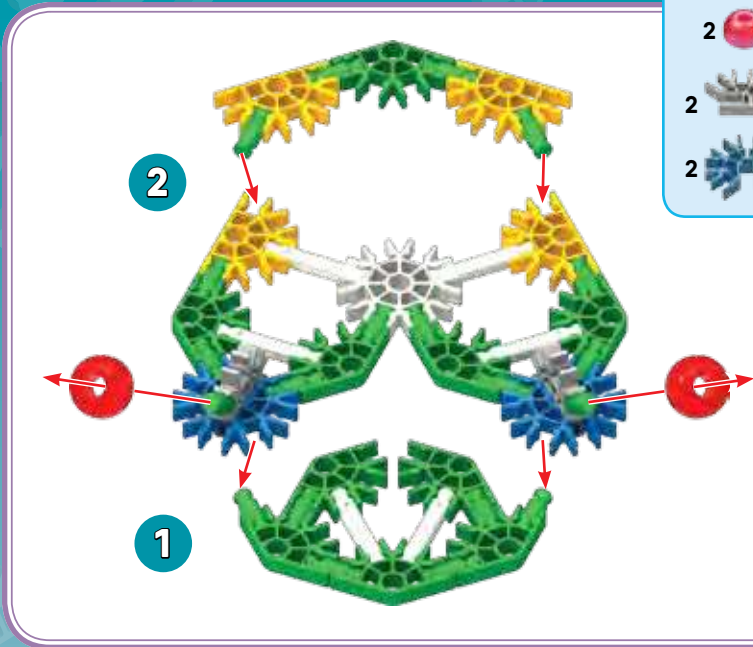
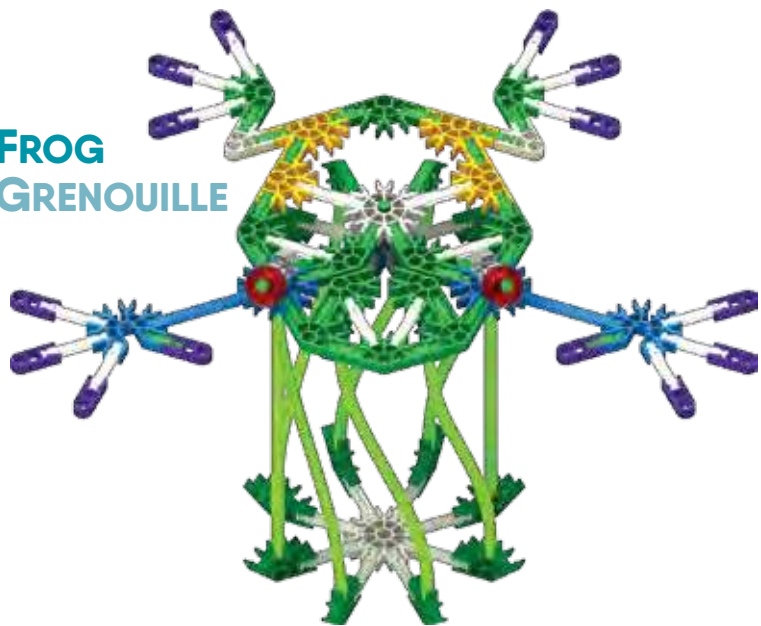

- | | | | |
|----|--|----|--|
| 20 | | 6 | |
| 2 | | 10 | |
| 2 | | 4 | |
| 2 | | 1 | |



- | | | | |
|----|--|----|--|
| 6 | | 12 | |
| 2 | | 2 | |
| 14 | | 2 | |
| 2 | | 2 | |

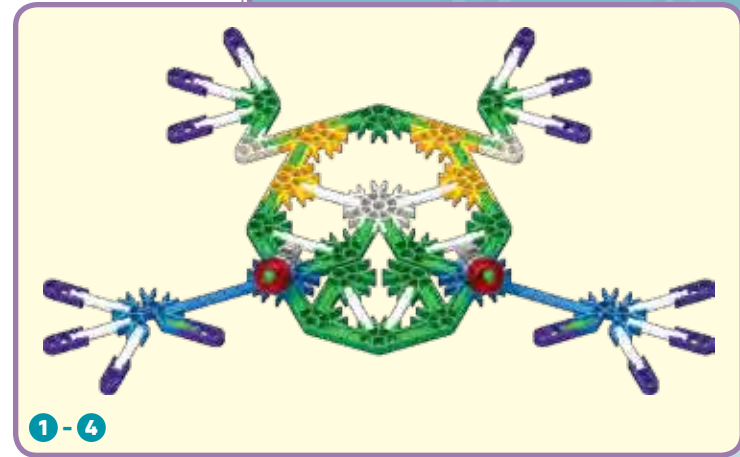
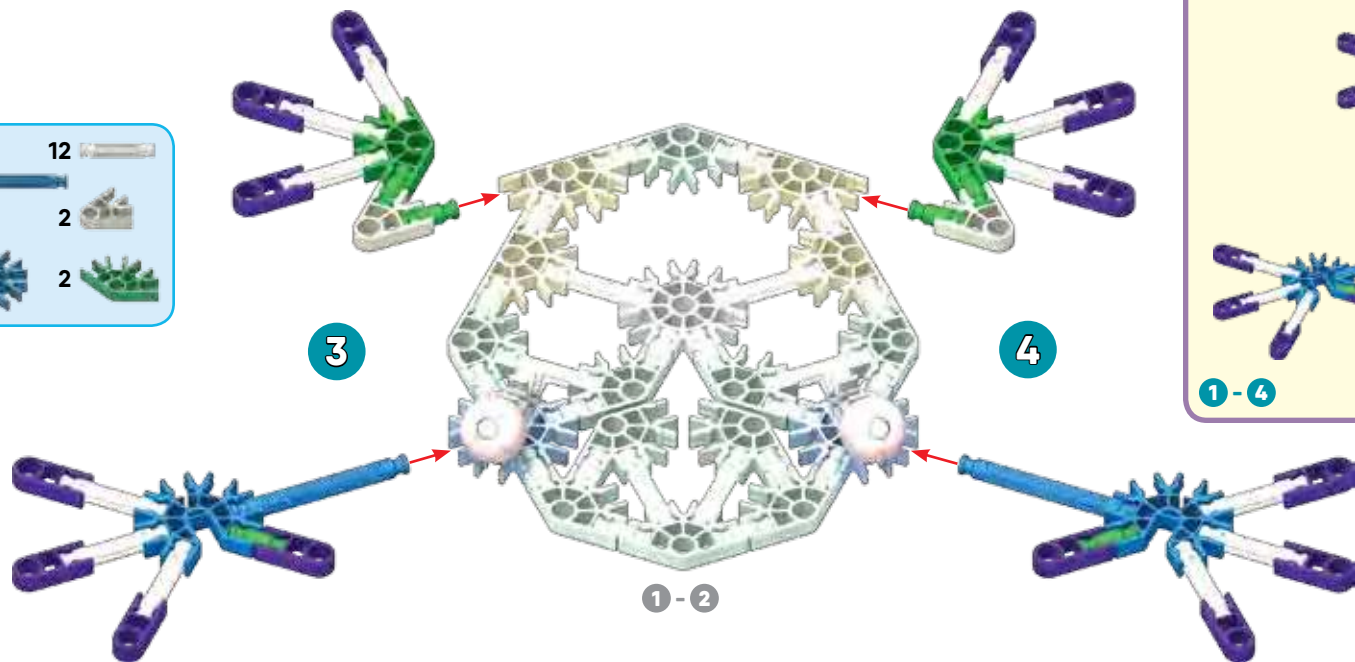

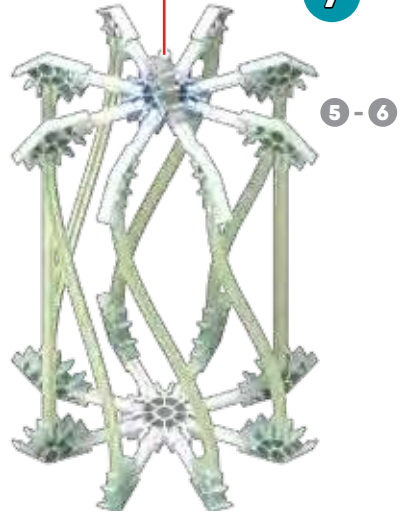
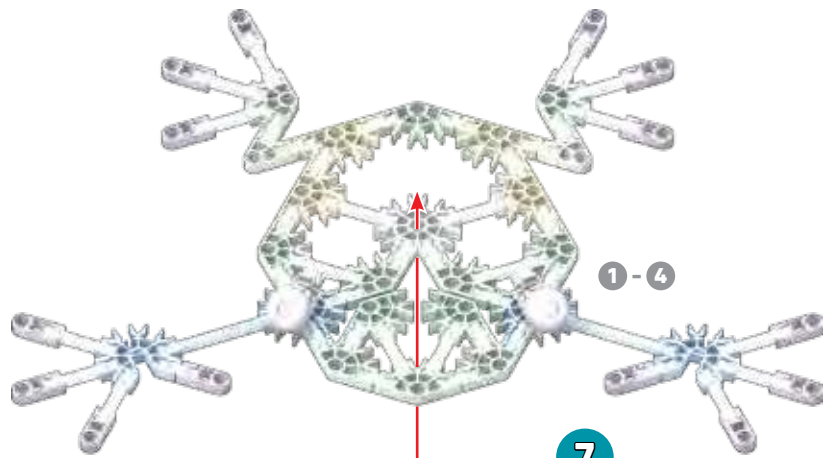
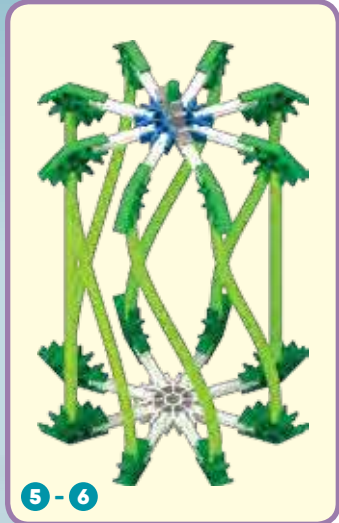
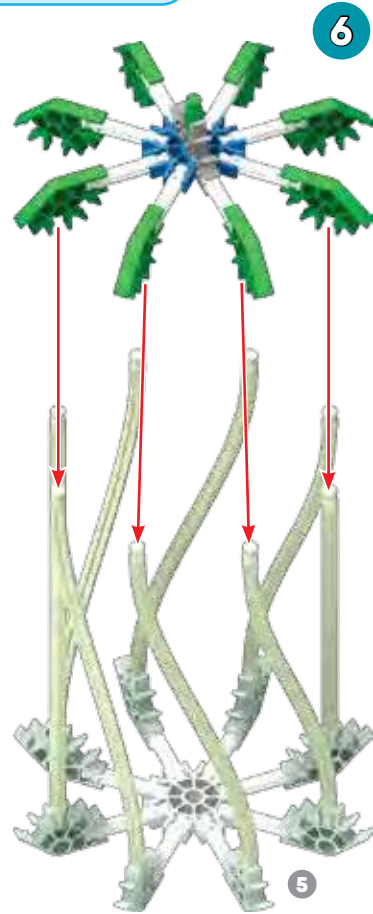
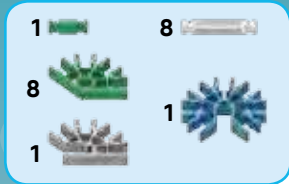
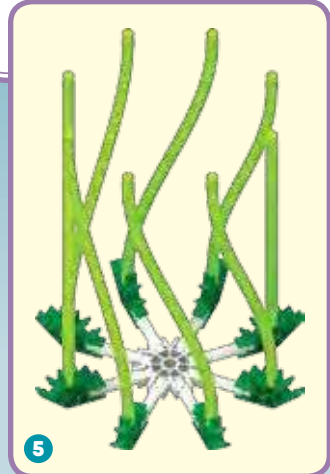
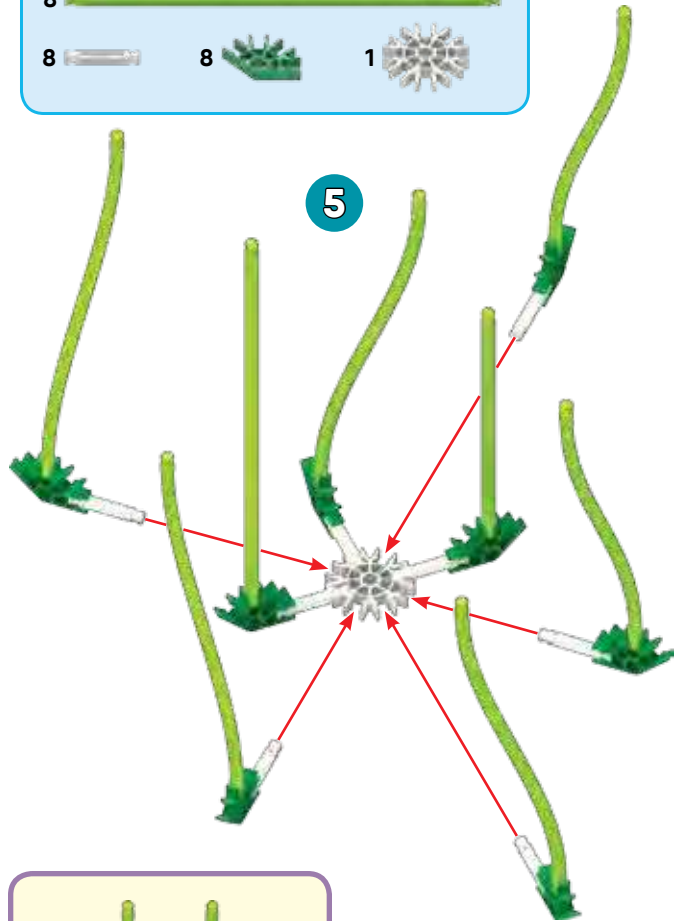
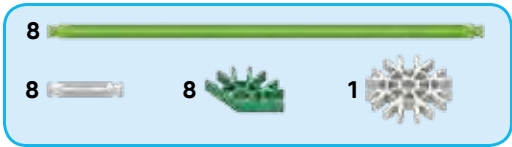

FAN VENTILATEUR



- | | |
|----|---|
| 1 | 2 |
| 10 | 3 |
| 1 | |
| 1 | 2 |
| 8 | 1 |
| 1 | |

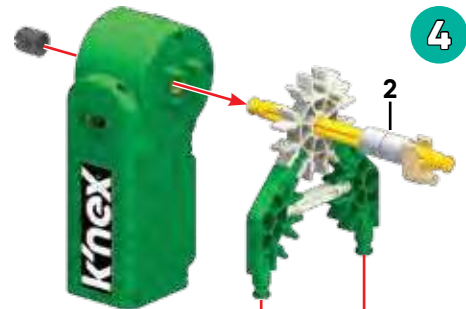

4

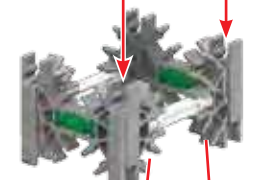

3

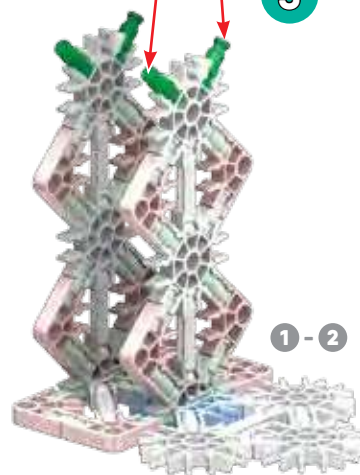

1-2

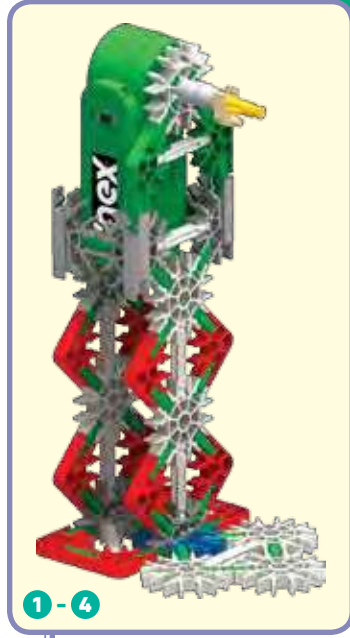

1-4

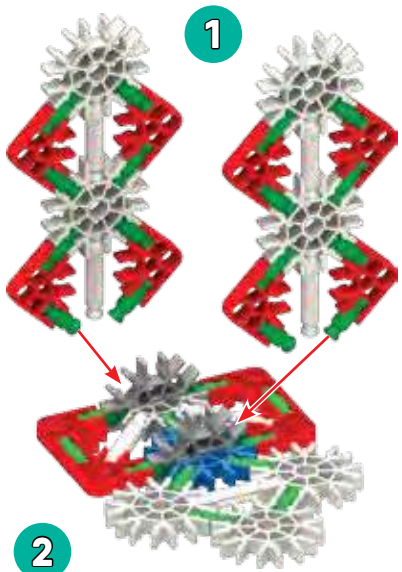

1

- | | |
|----|---|
| 27 | 7 |
| 12 | 7 |
| 3 | 1 |

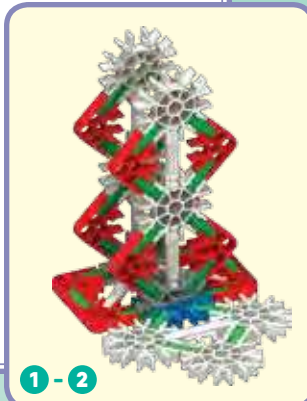

1-2

- (EN) Did you install 2 AA (or LR6) batteries in the motor?
- (FR) Avez-vous installé 2 piles AA (ou LR6) ?
- (ES) ¿Instalaste 2 pilas AA (o LR6) en el motor?
- (DE) Hast du 2 AA (oder LR6) Batterien in den Motor eingelegt?
- (IT) Hai installato 2 batterie AA (o LR6) nel motore?
- (PT) Foram instaladas as pilhas 2 AA (ou LR6) no motor?
- (NL) Heb je 2 AA (of LR6)-batterijen in de motor geplaatst?

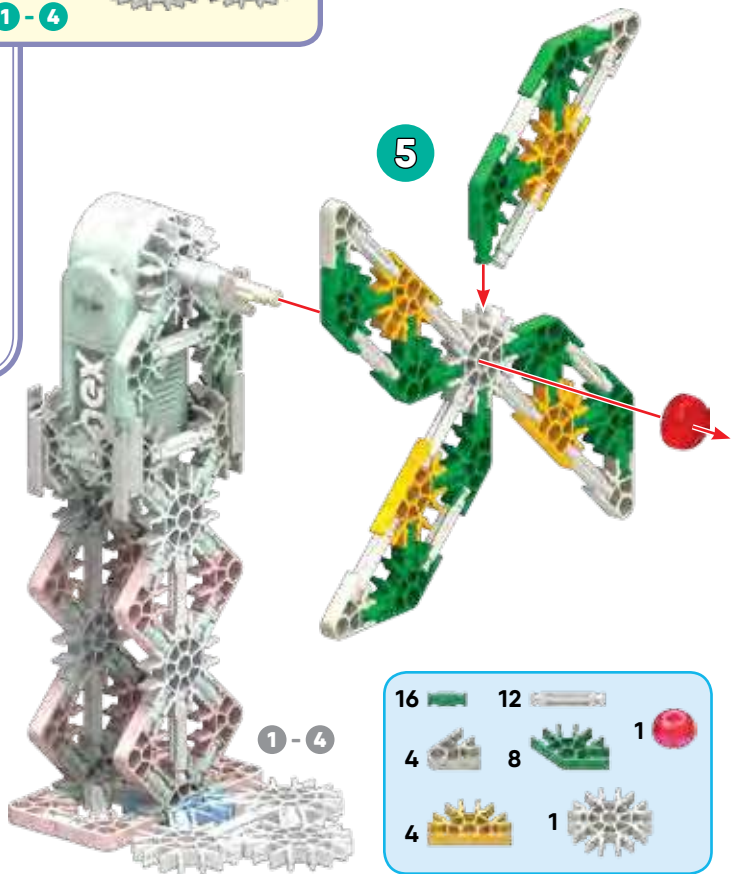

5

1-4

- | | | |
|----|----|---|
| 16 | 12 | 1 |
| 4 | 8 | |
| 4 | 1 | |

TRACTOR TRACTEUR

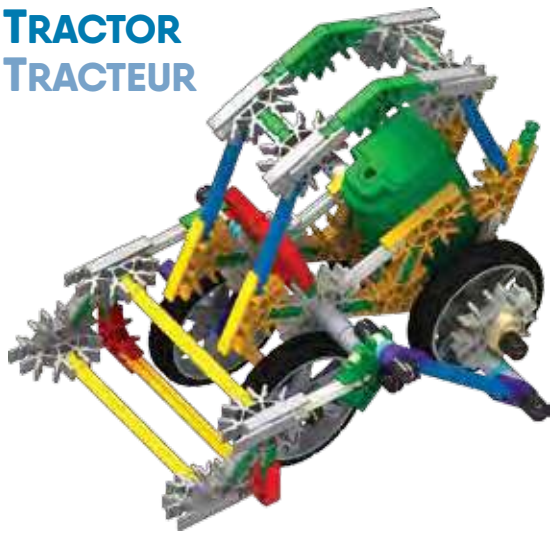

- (EN) Did you install 2 AA (or LR6) batteries in the motor?
- (FR) Avez-vous installé 2 piles AA (ou LR6) ?
- (ES) ¿Instalaste 2 pilas AA (o LR6) en el motor?
- (DE) Hast du 2 AA (oder LR6) Batterien in den Motor eingelegt?
- (IT) Hai installato 2 batterie AA (o LR6) nel motore?
- (PT) Foram instaladas as pilhas 2 AA (ou LR6) no motor?
- (NL) Heb je 2 AA (of LR6)-batterijen in de motor geplaatst?

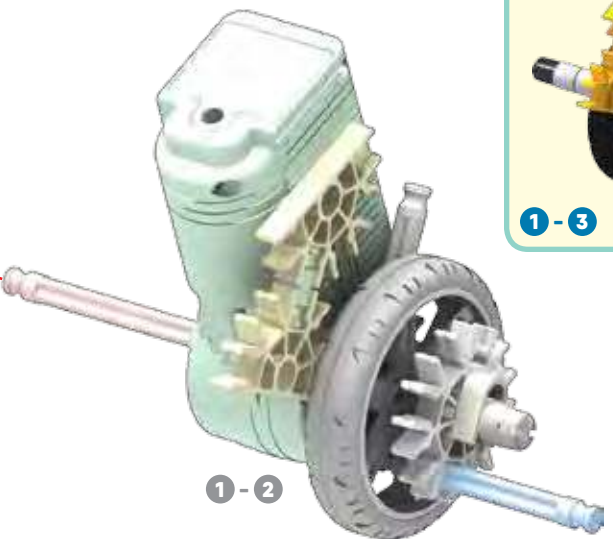
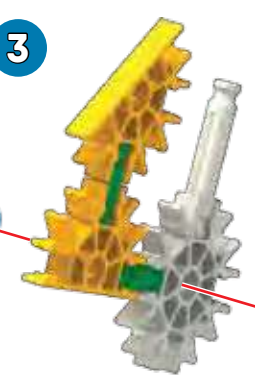
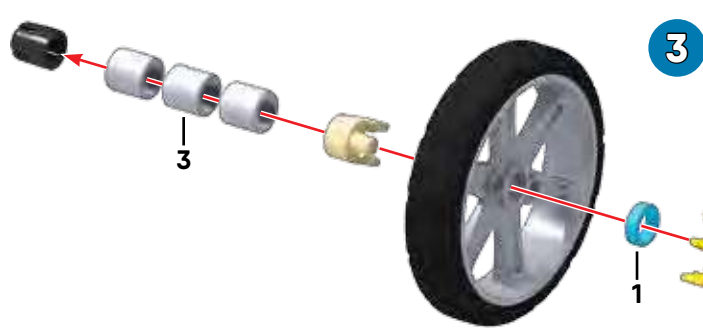
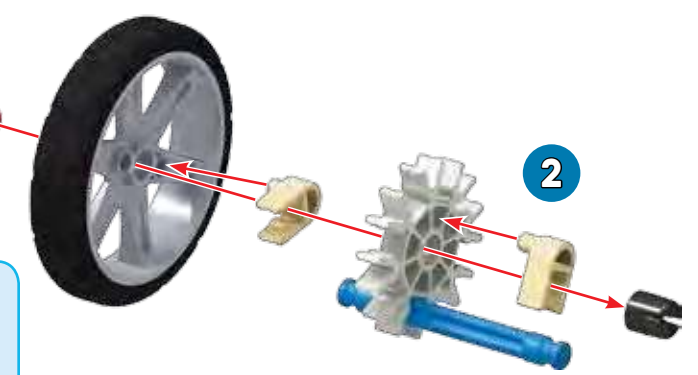
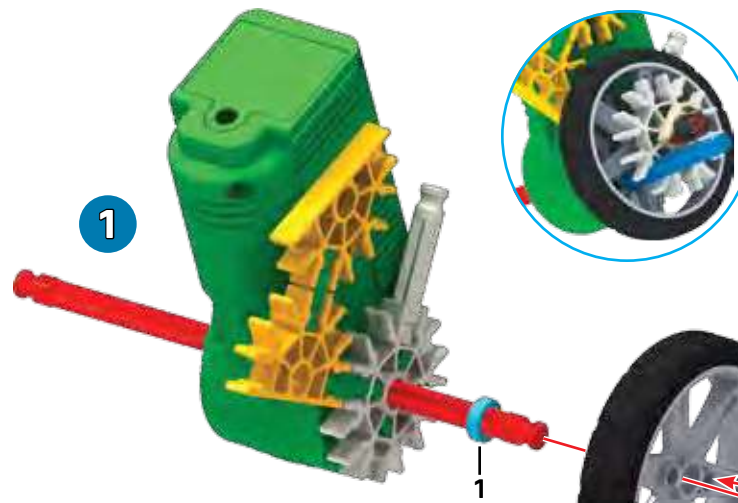

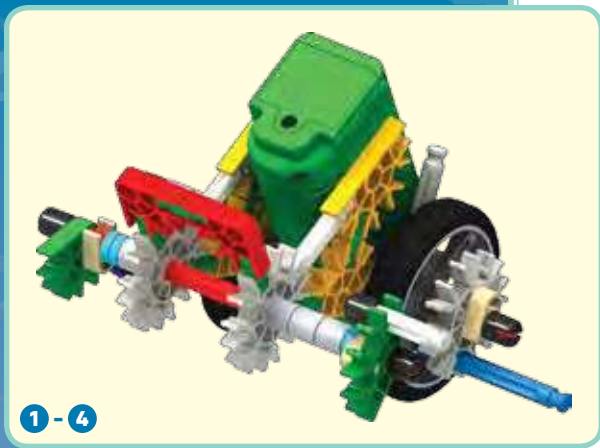

- | | | | | | | | |
|---|--|---|--|---|--|---|--|
| 1 | | 3 | | 3 | | 3 | |
| 6 | | 3 | | 3 | | 3 | |
| 2 | | 1 | | 4 | | 2 | |
| 2 | | 2 | | 2 | | 2 | |

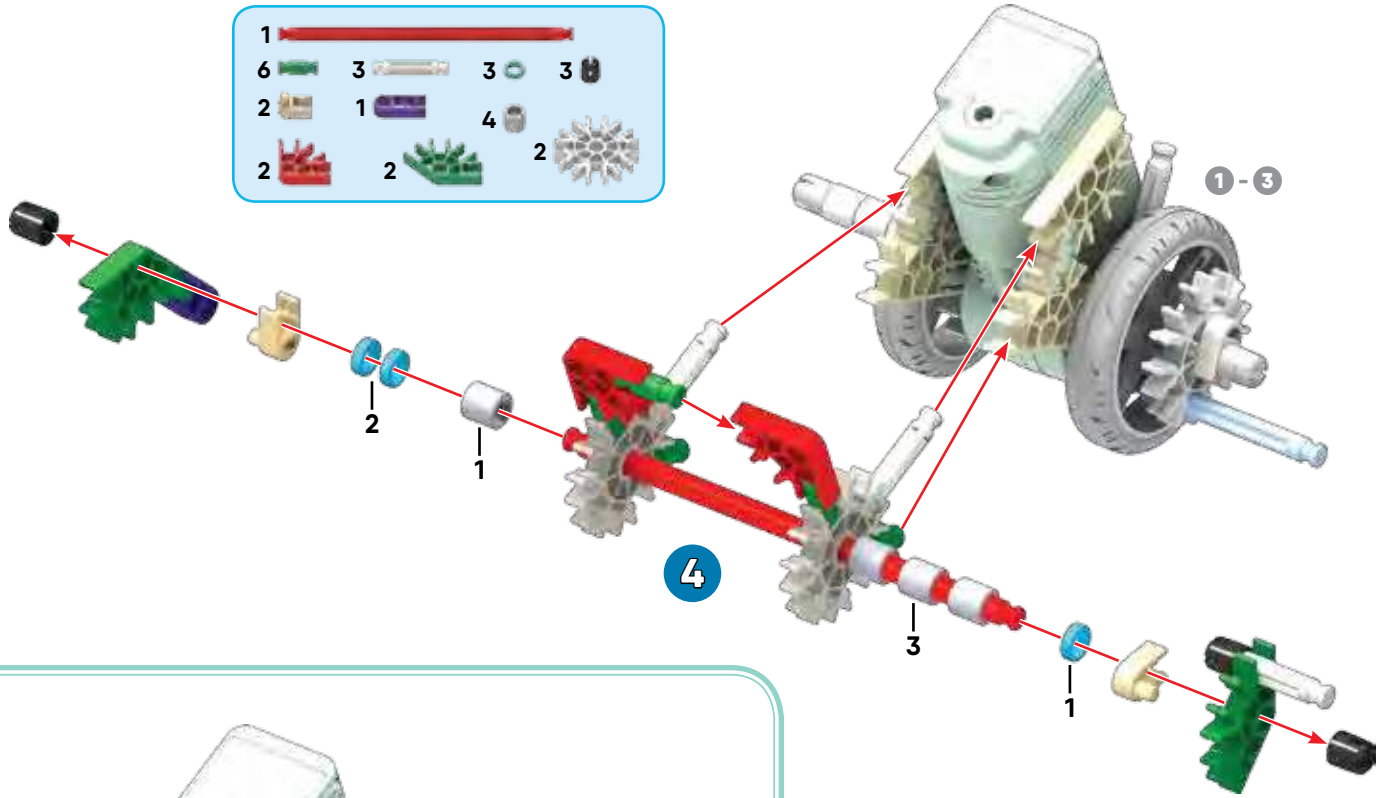

- | | | | | | |
|---|--|---|--|---|--|
| 2 | | 1 | | 2 | |
| 3 | | 2 | | 2 | |
| | | 1 | | 1 | |
| | | 1 | | 1 | |

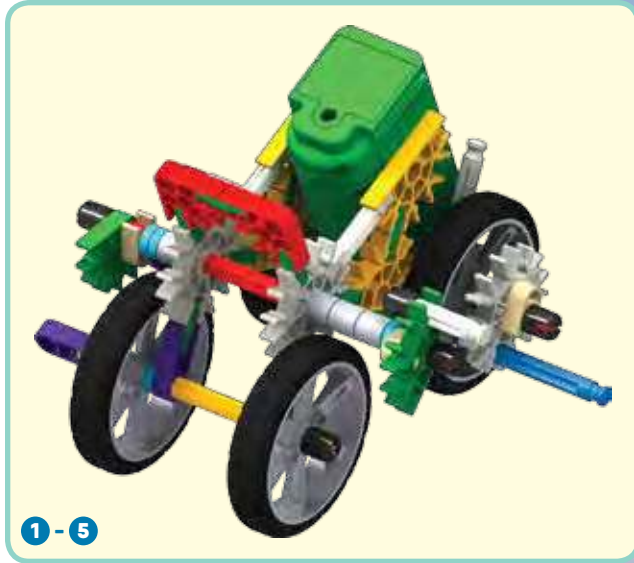
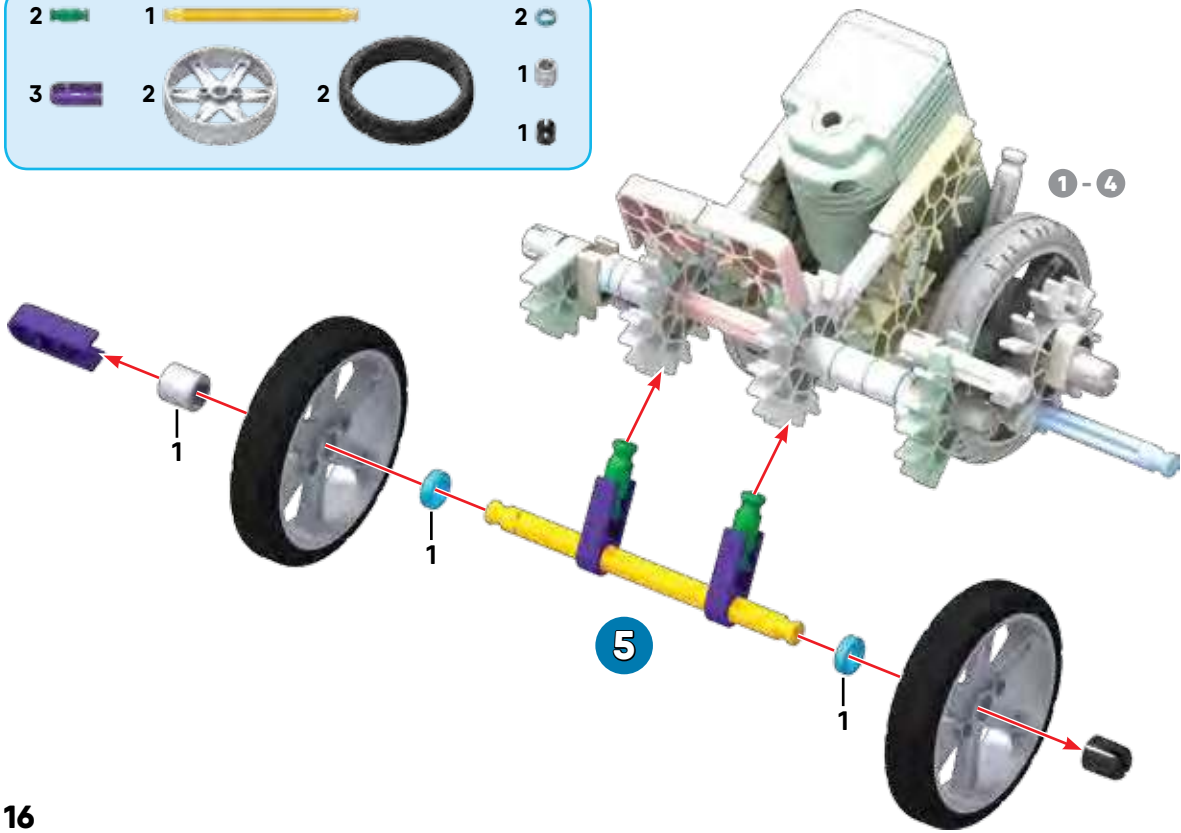

- 4 2 2 2
- 1 3
- 2 2 2 8

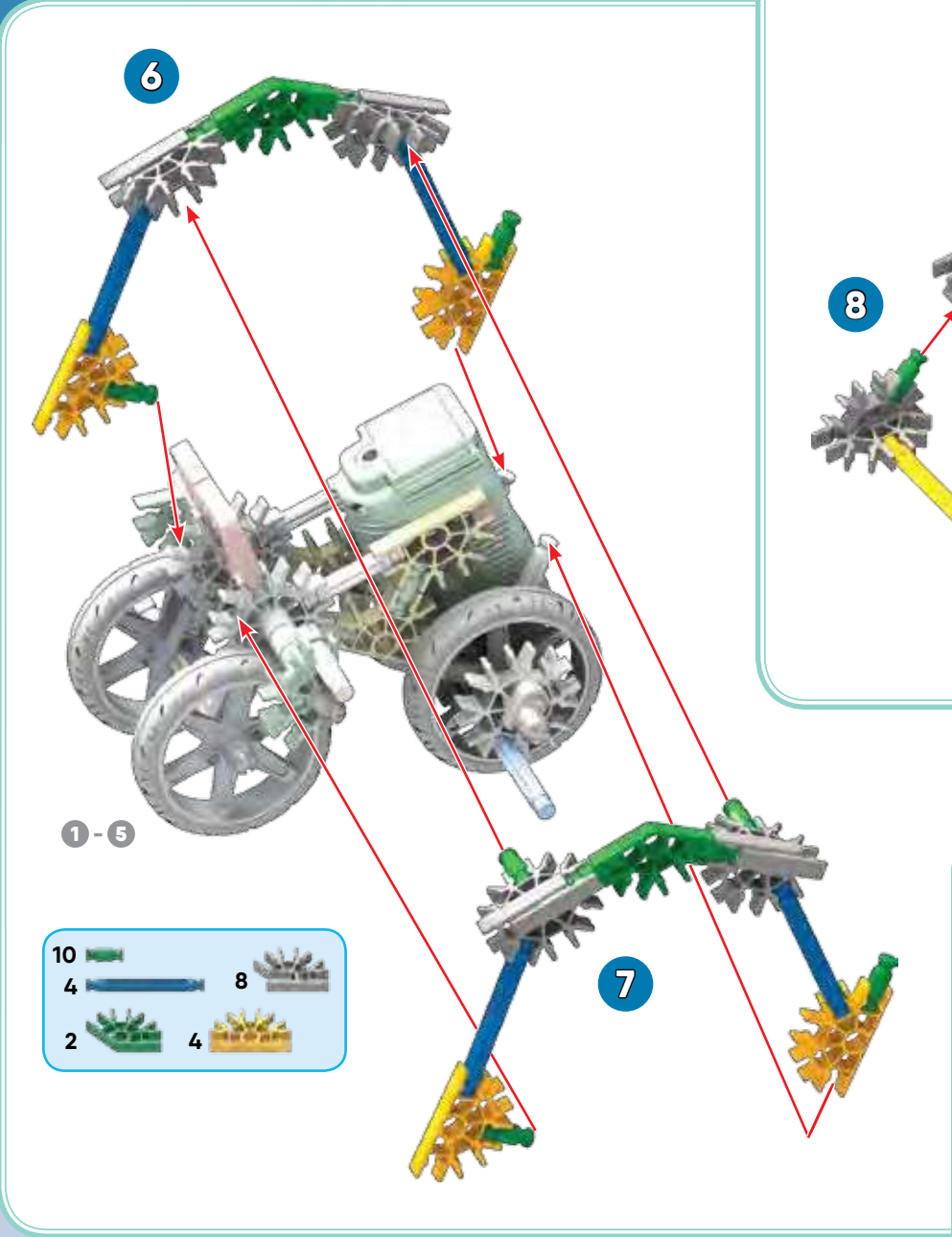

- 10 8
- 4 4
- 2 4

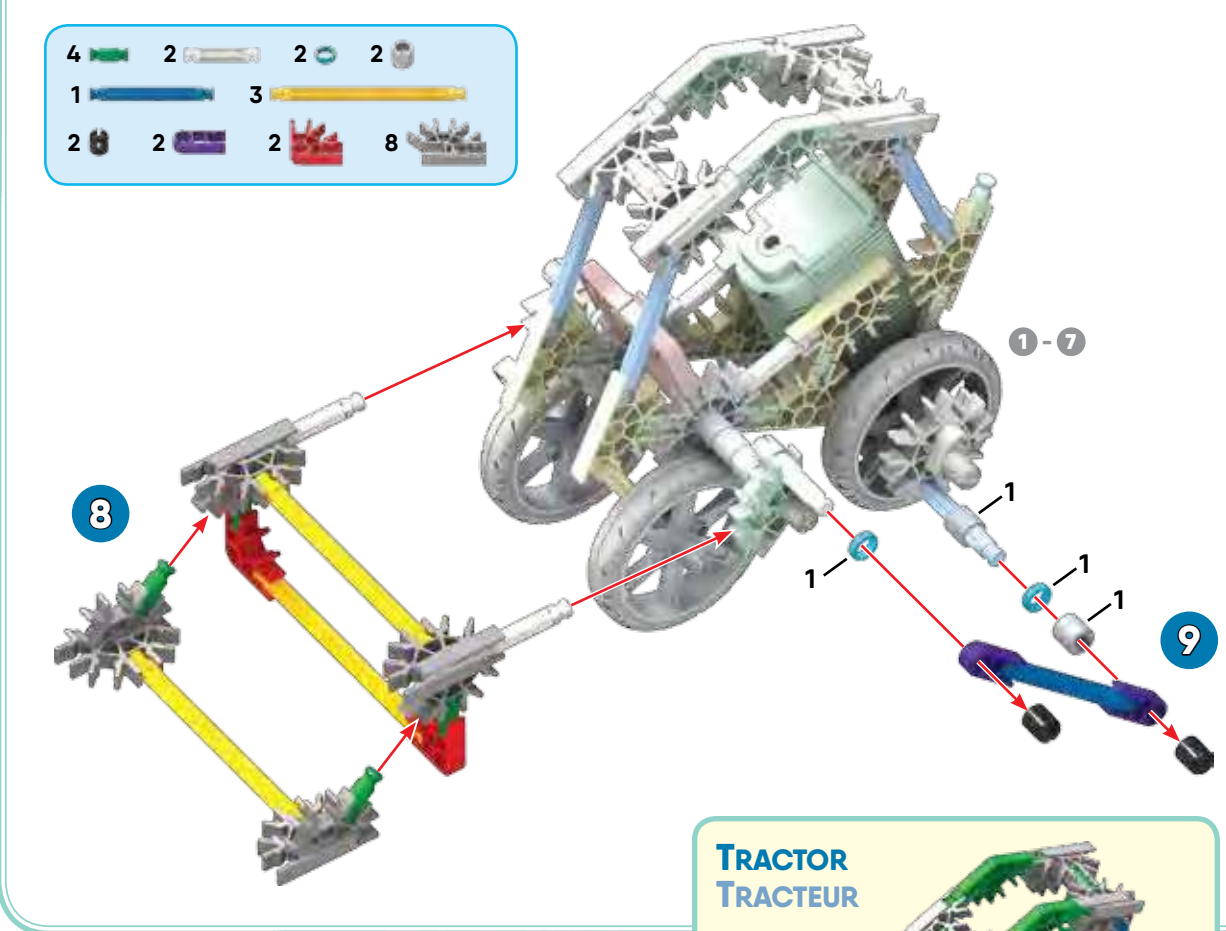

BI-PLANE BIPLAN

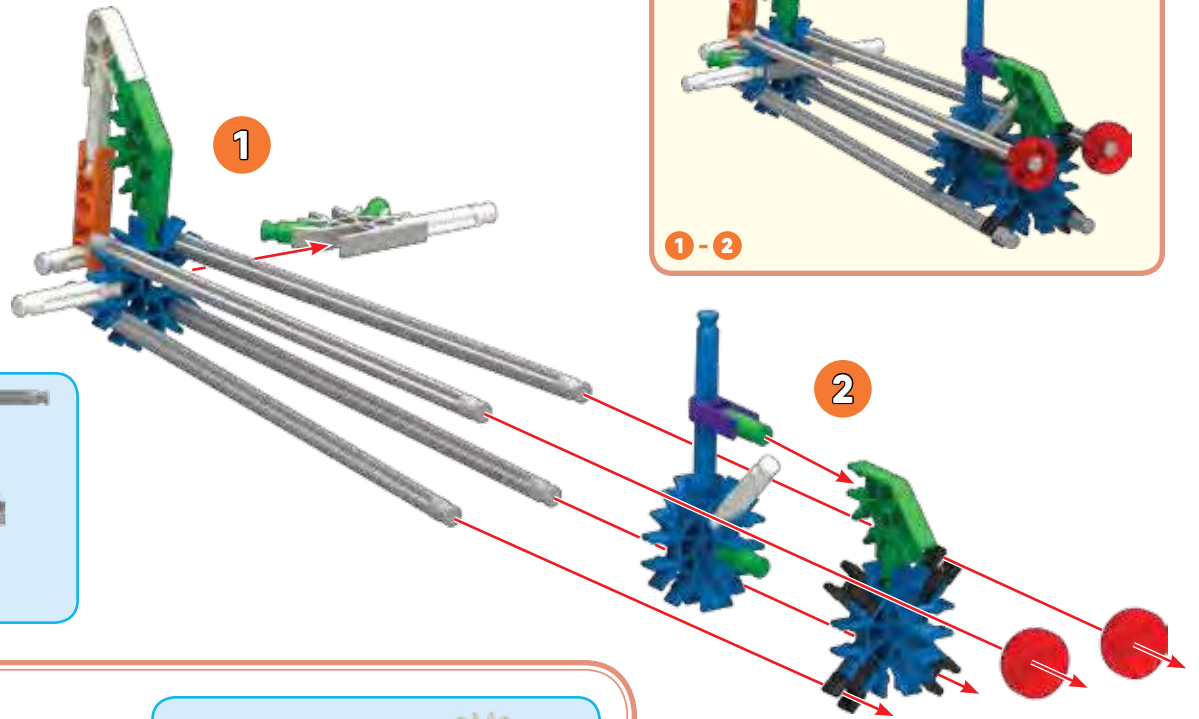

- | | | | | | | | |
|---|--|---|--|---|--|---|--|
| 4 | | 5 | | 4 | | 2 | |
| 1 | | 1 | | 1 | | 1 | |
| 5 | | 2 | | 1 | | | |

- | | | | | | |
|---|--|---|--|---|--|
| 4 | | 2 | | 5 | |
| 6 | | 2 | | | |
| 2 | | 2 | | 4 | |

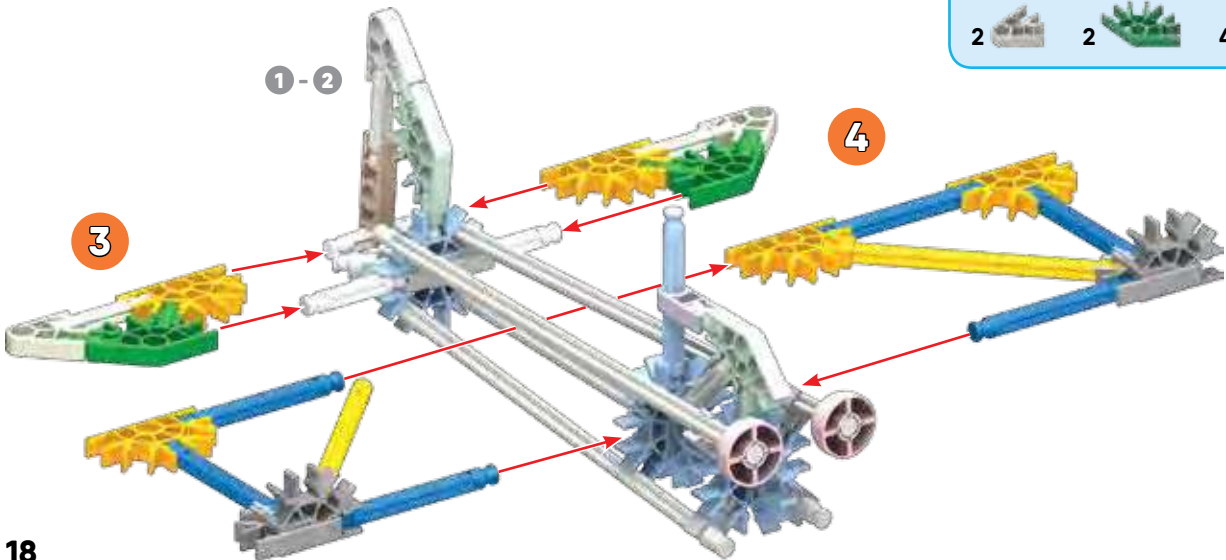

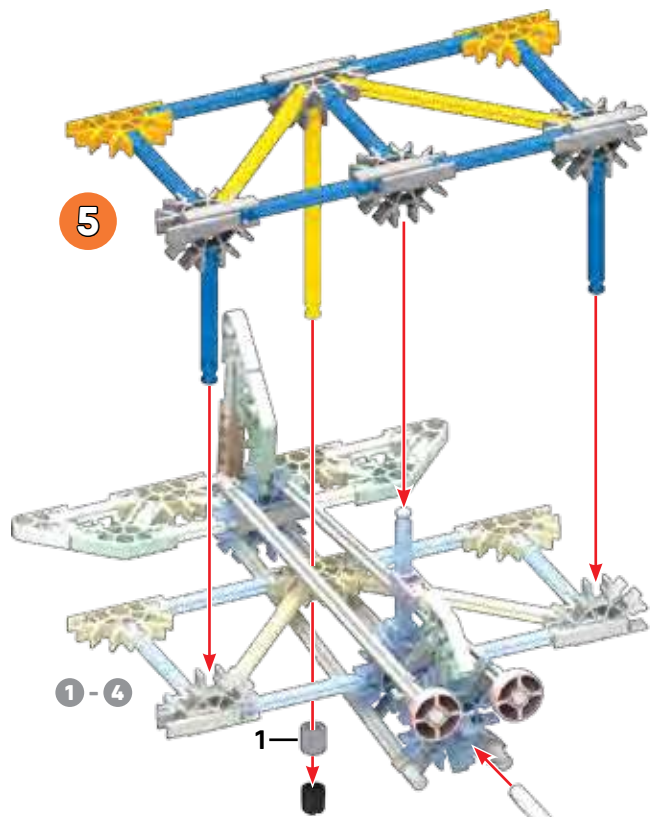

5

1-4

1



8

4

8

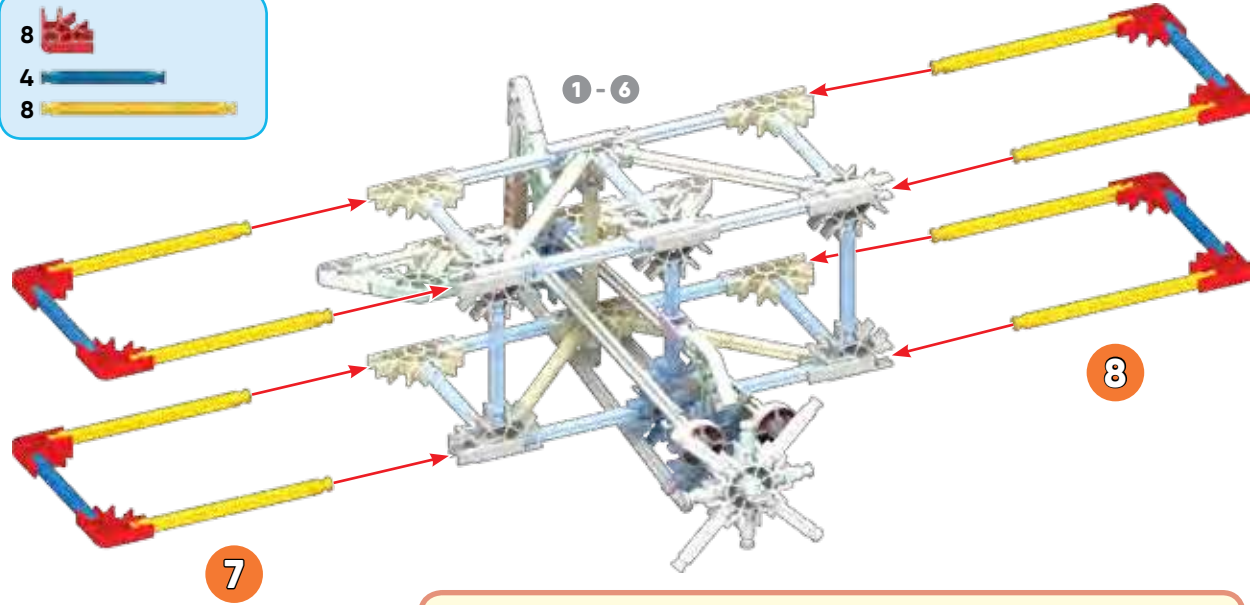

1-6

7

8



4

5

2

2

9

3

3

8

2

1

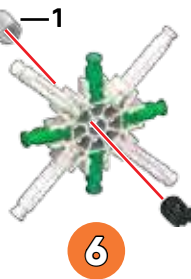

6

**BI-PLANE
BIPLAN**



1-8



1-6

DRILL

FORET

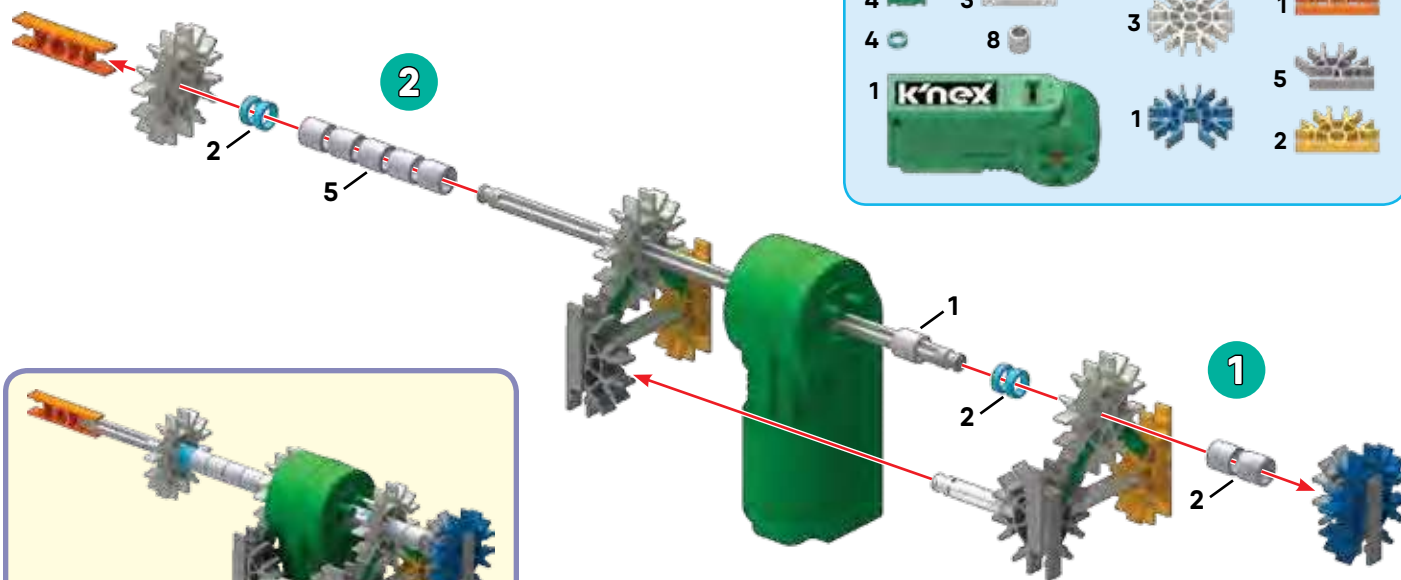

- | | | | |
|---|---|---|---|
| 1 | 3 | 3 | 1 |
| 4 | 8 | 1 | 5 |
| 4 | | 1 | 2 |
| 1 | | | |
- 1 K'nex Motor



- (EN) Did you install 2 AA (or LR6) batteries in the motor?
- (FR) Avez-vous installé 2 piles AA (ou LR6) ?
- (ES) ¿Instalaste 2 pilas AA (o LR6) en el motor?
- (DE) Hast du 2 AA (oder LR6) Batterien in den Motor eingelegt?
- (IT) Hai installato 2 batterie AA (o LR6) nel motore?
- (PT) Foram instaladas as pilhas 2 AA (ou LR6) no motor?
- (NL) Heb je 2 AA (of LR6)-batterijen in de motor geplaatst?

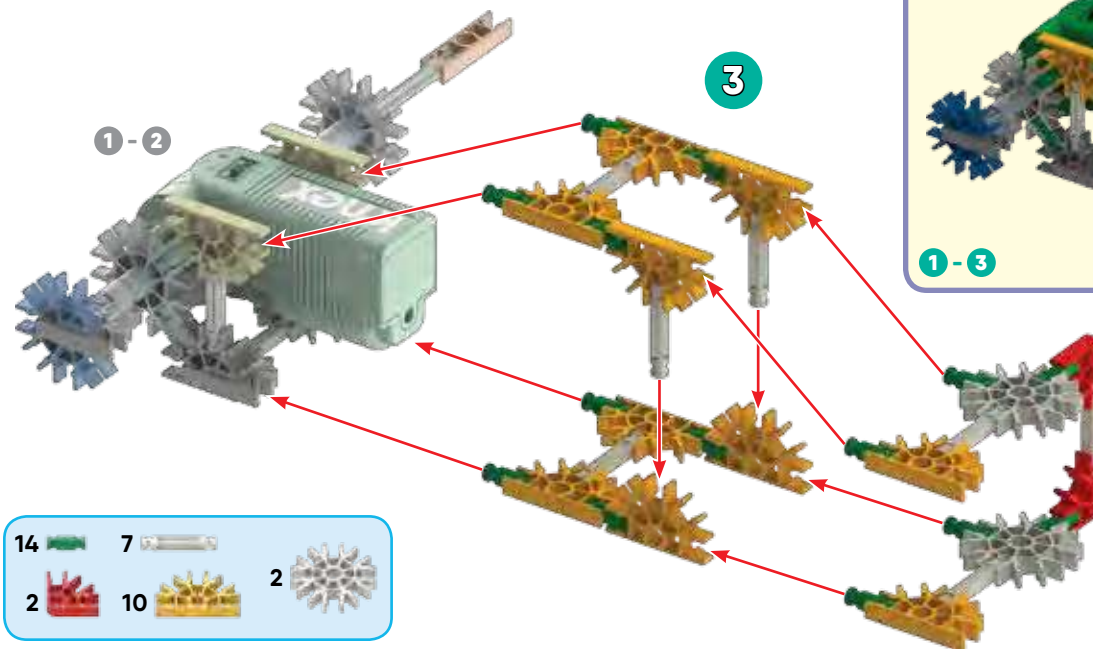

- | | | |
|----|----|---|
| 14 | 7 | 2 |
| 2 | 10 | 2 |

rotate model
pivoter
le modèle

- (ES) gire modelo
- (DE) drehe das Modell
- (IT) gira il modello
- (PT) gire modelo
- (NL) draai model

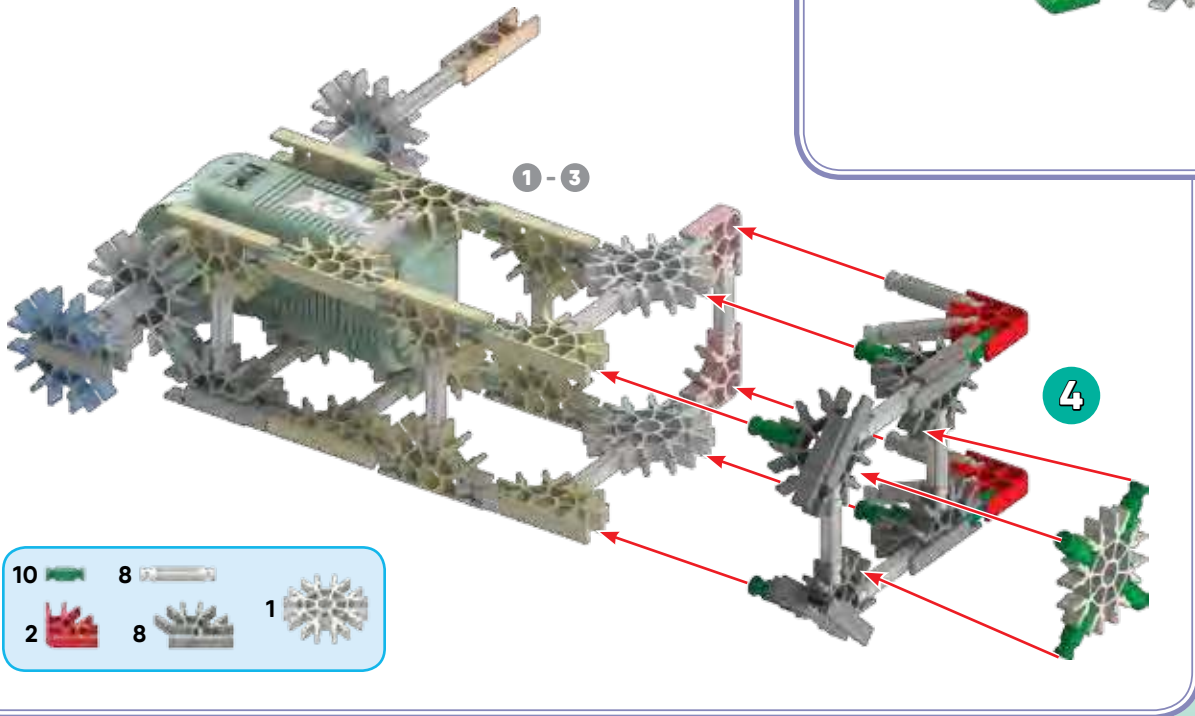
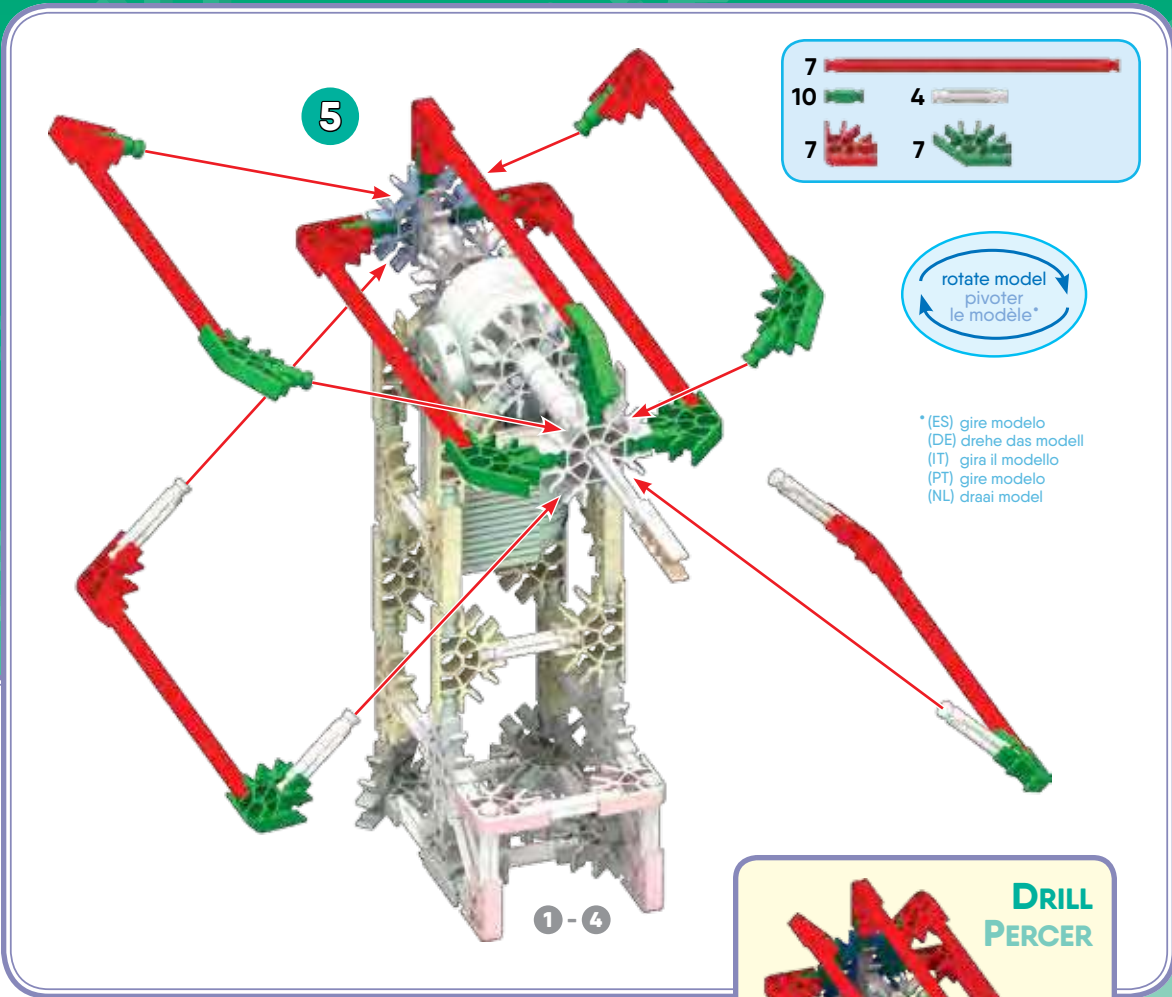

BUS AUTOBUS

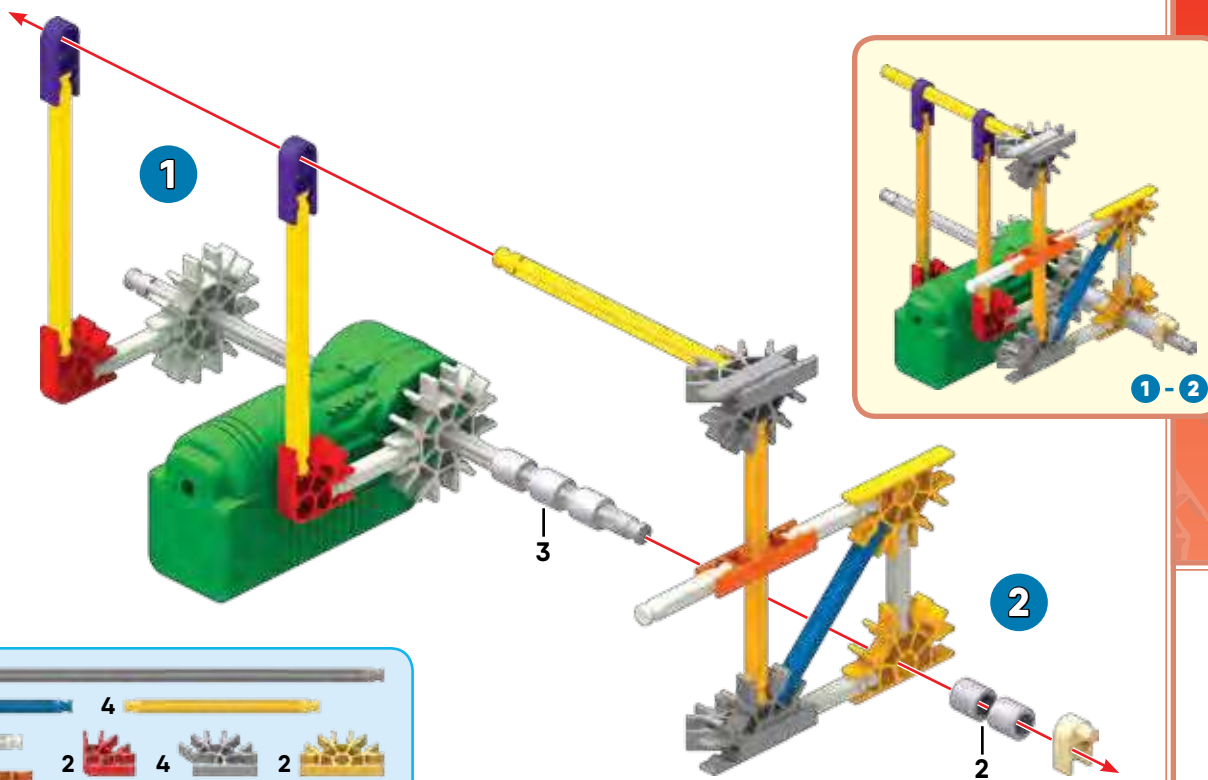

(EN) Did you install 2 AA (or LR6) batteries in the motor?

(FR) Avez-vous installé 2 piles AA (ou LR6) ?

(ES) ¿Instalaste 2 pilas AA (o LR6) en el motor?

(DE) Hast du 2 AA (oder LR6) Batterien in den Motor eingelegt?

(IT) Hai installato 2 batterie AA (o LR6) nel motore?

(PT) Foram instaladas as pilhas 2 AA (ou LR6) no motor?

(NL) Heb je 2 AA (of LR6)-batterijen in de motor geplaatst?

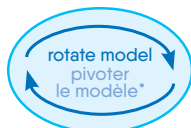

* (ES) gire modelo
(DE) drehe das Modell
(IT) gira il modello
(PT) gire modelo
(NL) draai model

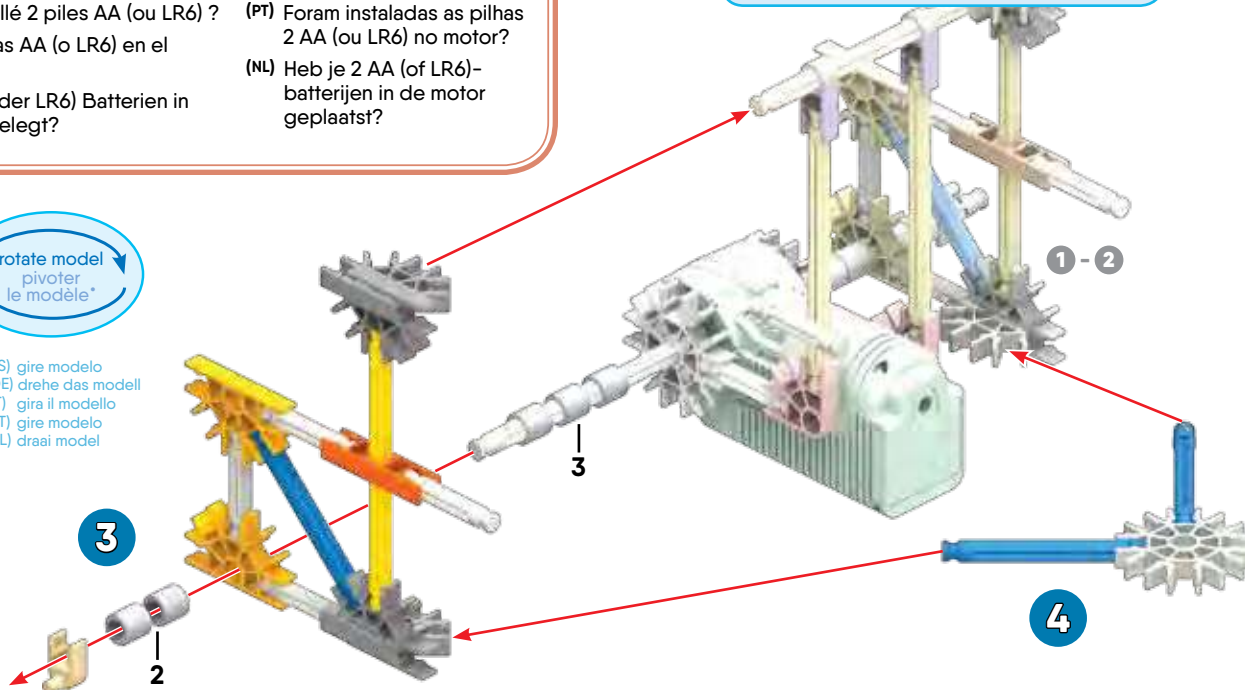

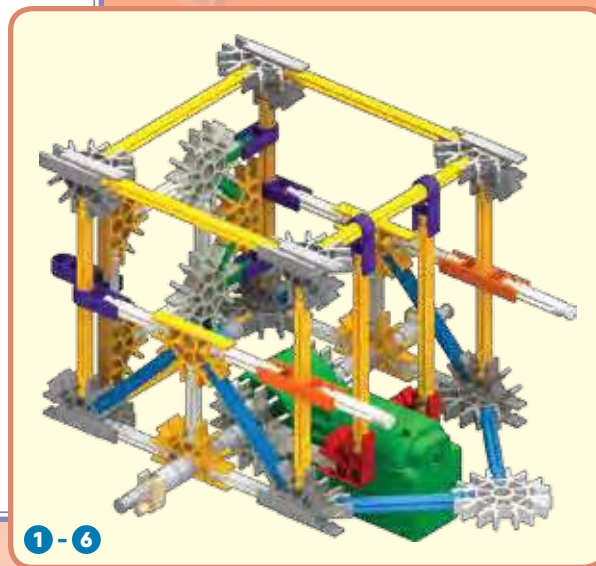
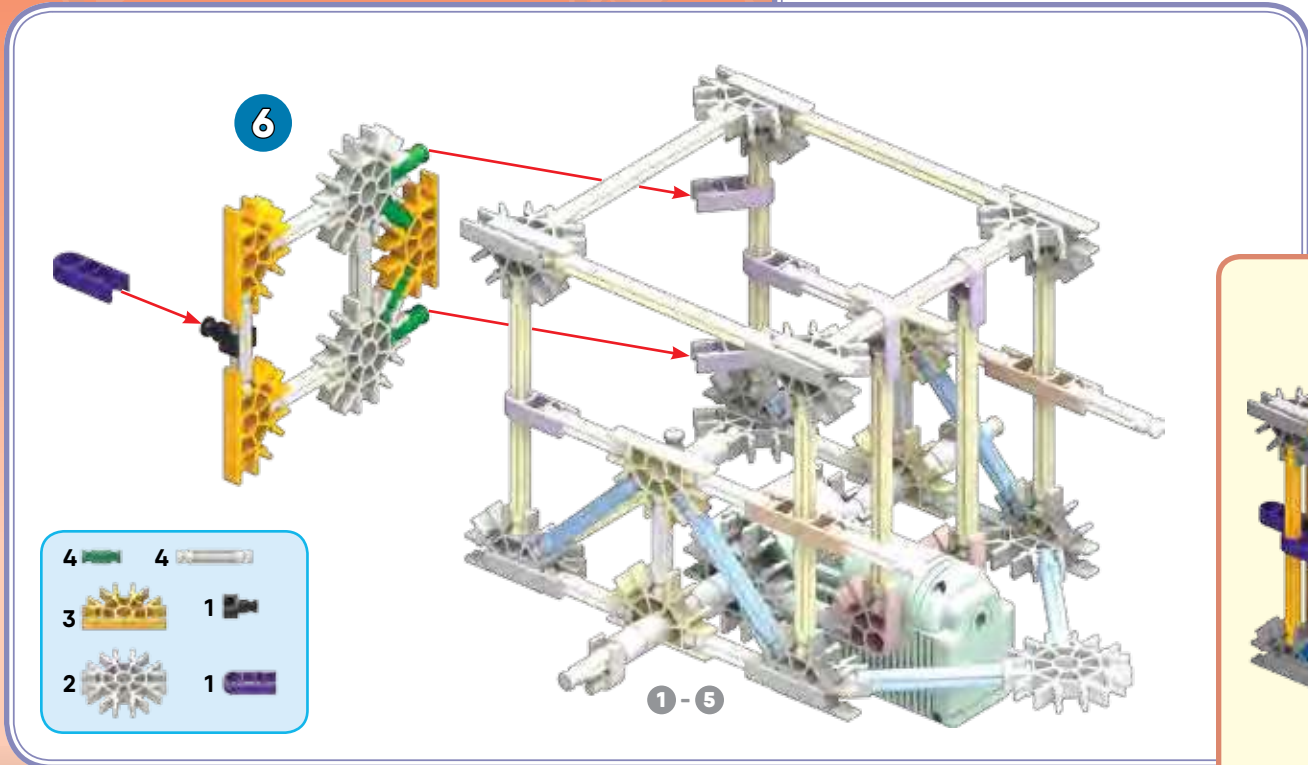
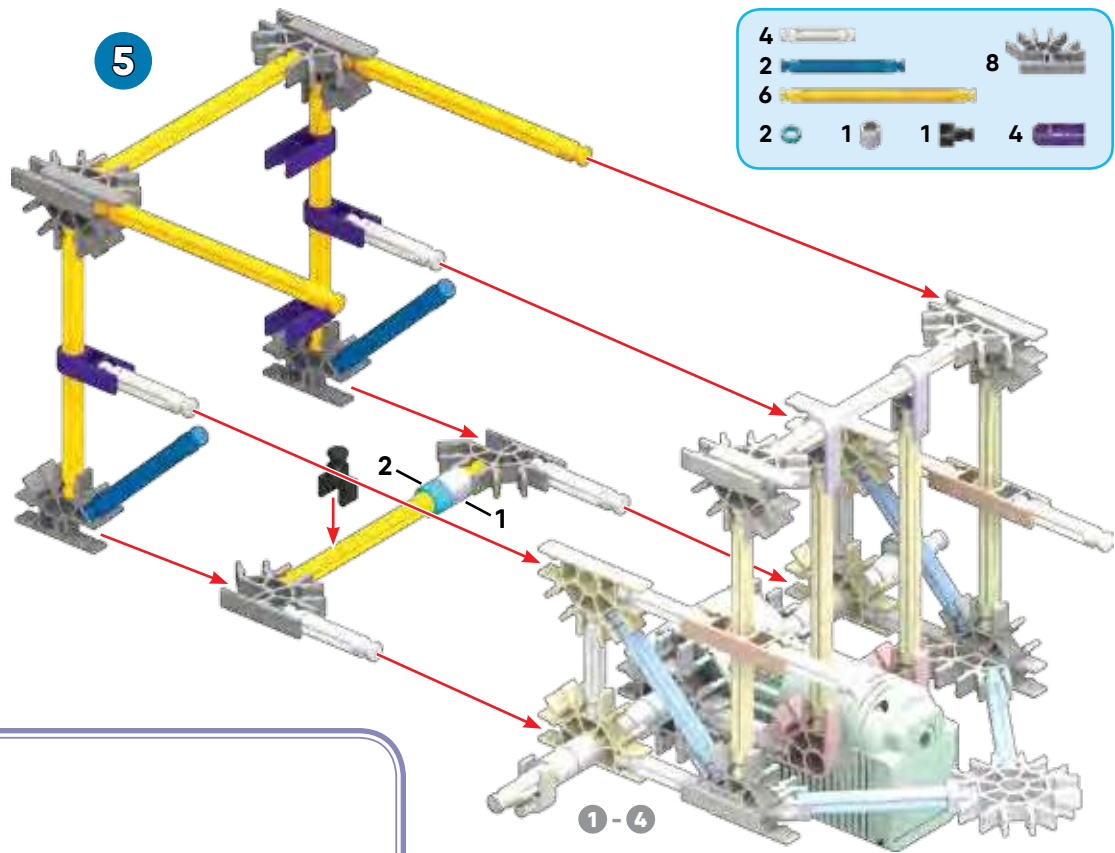
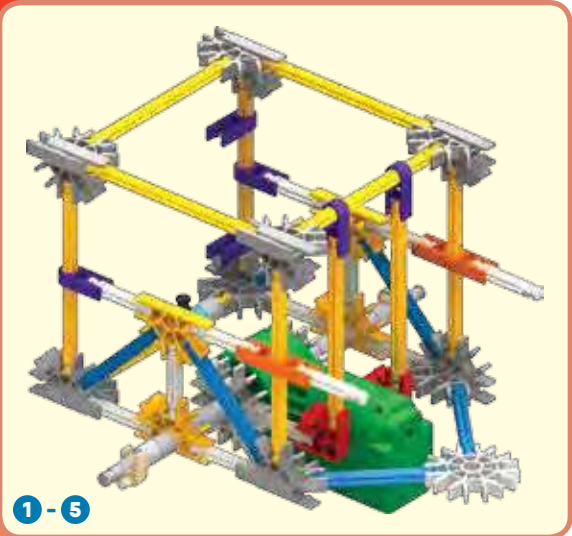

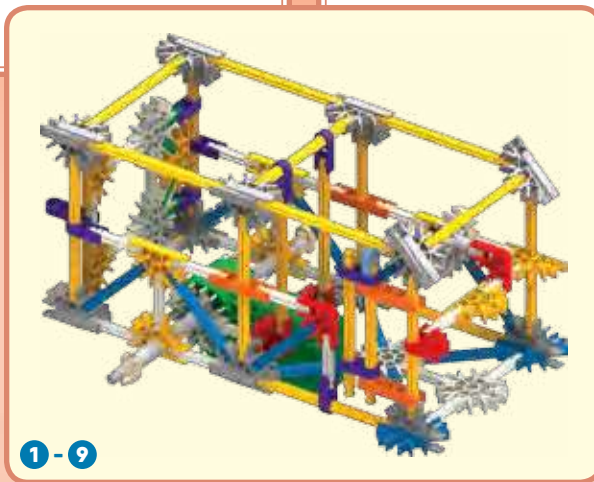
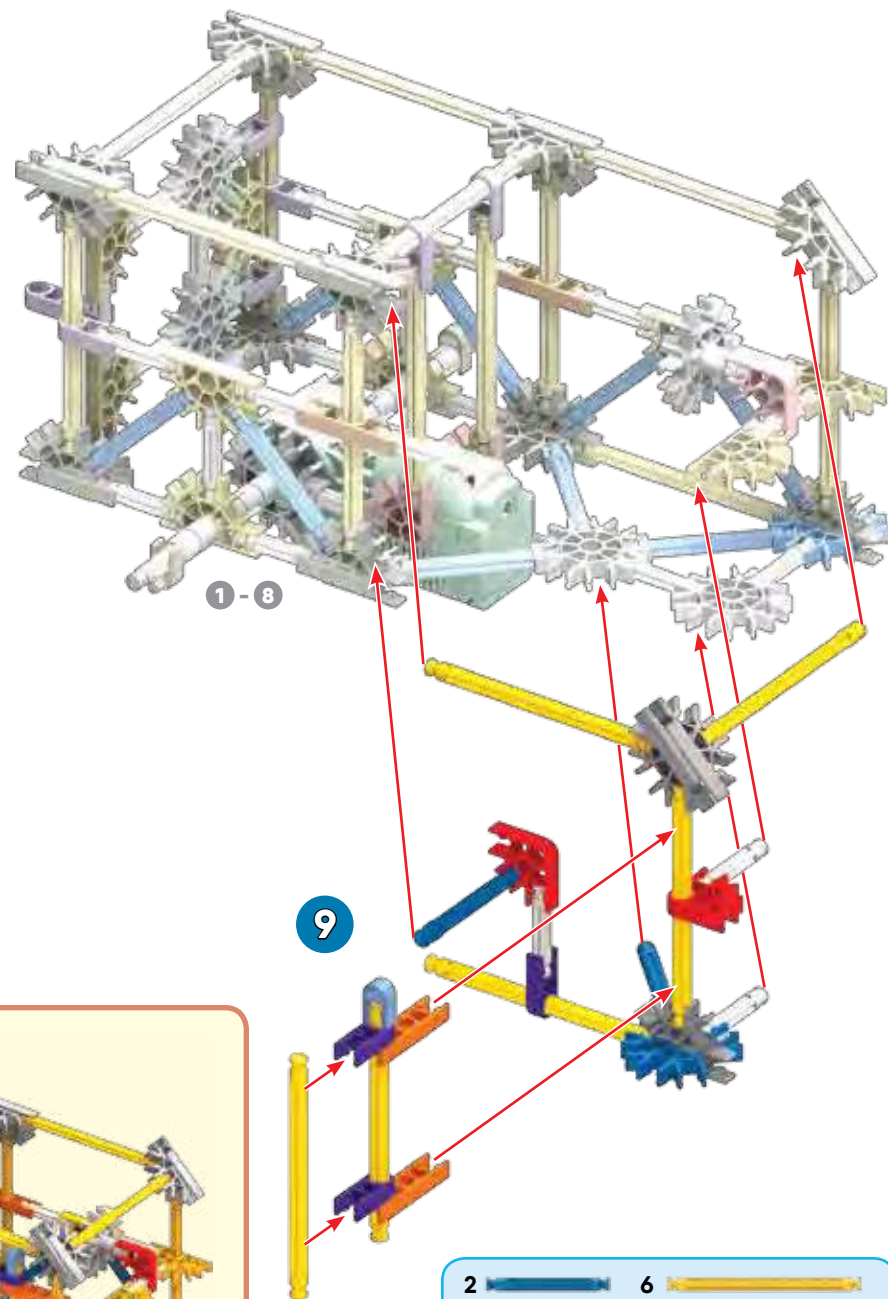
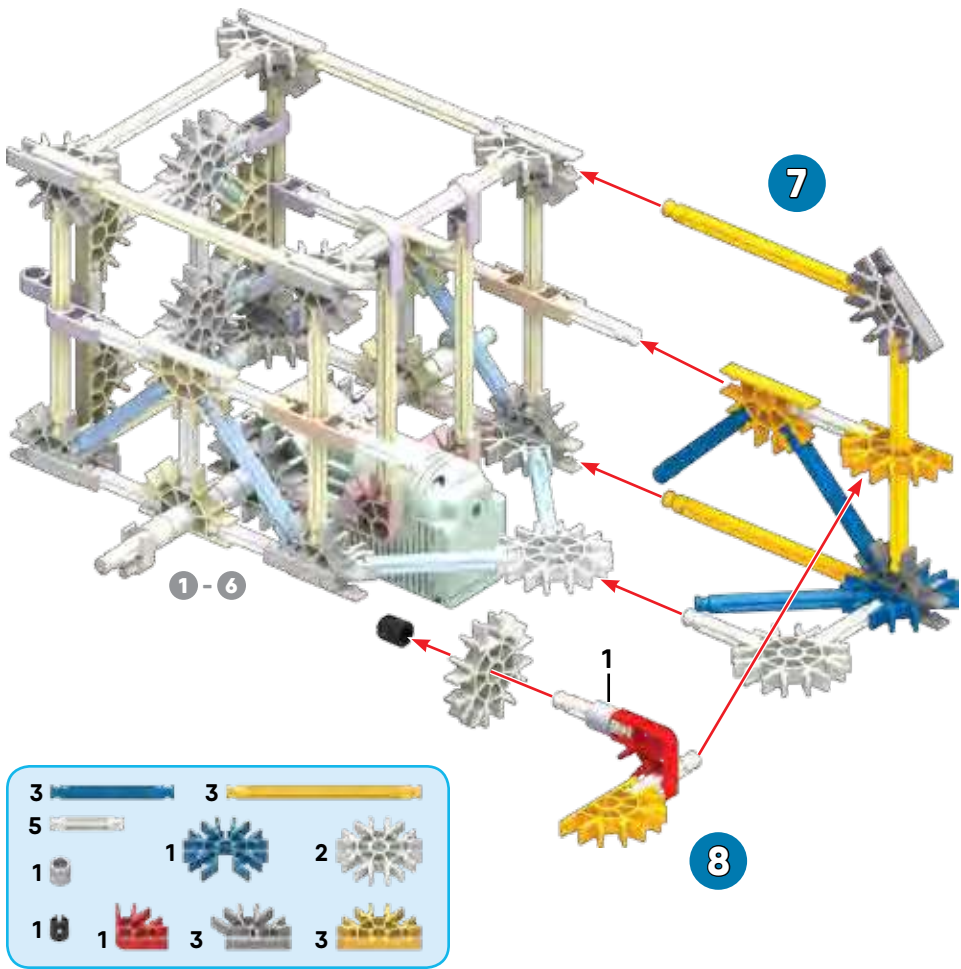

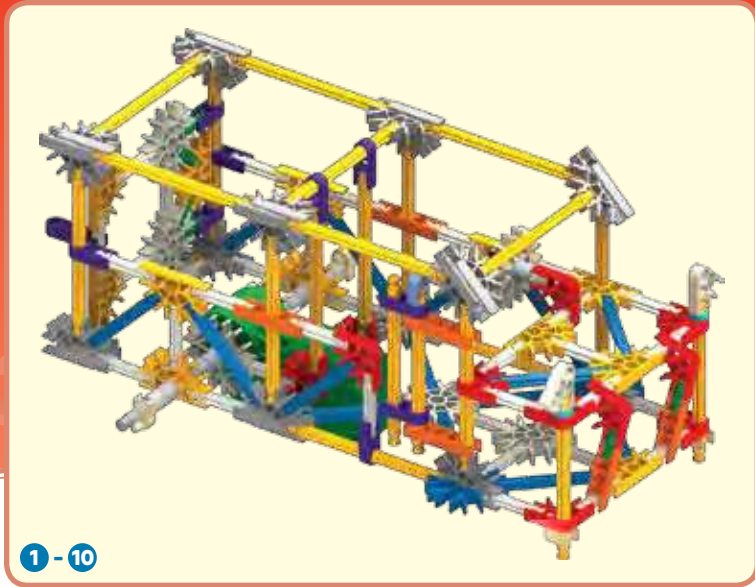

1 - 10

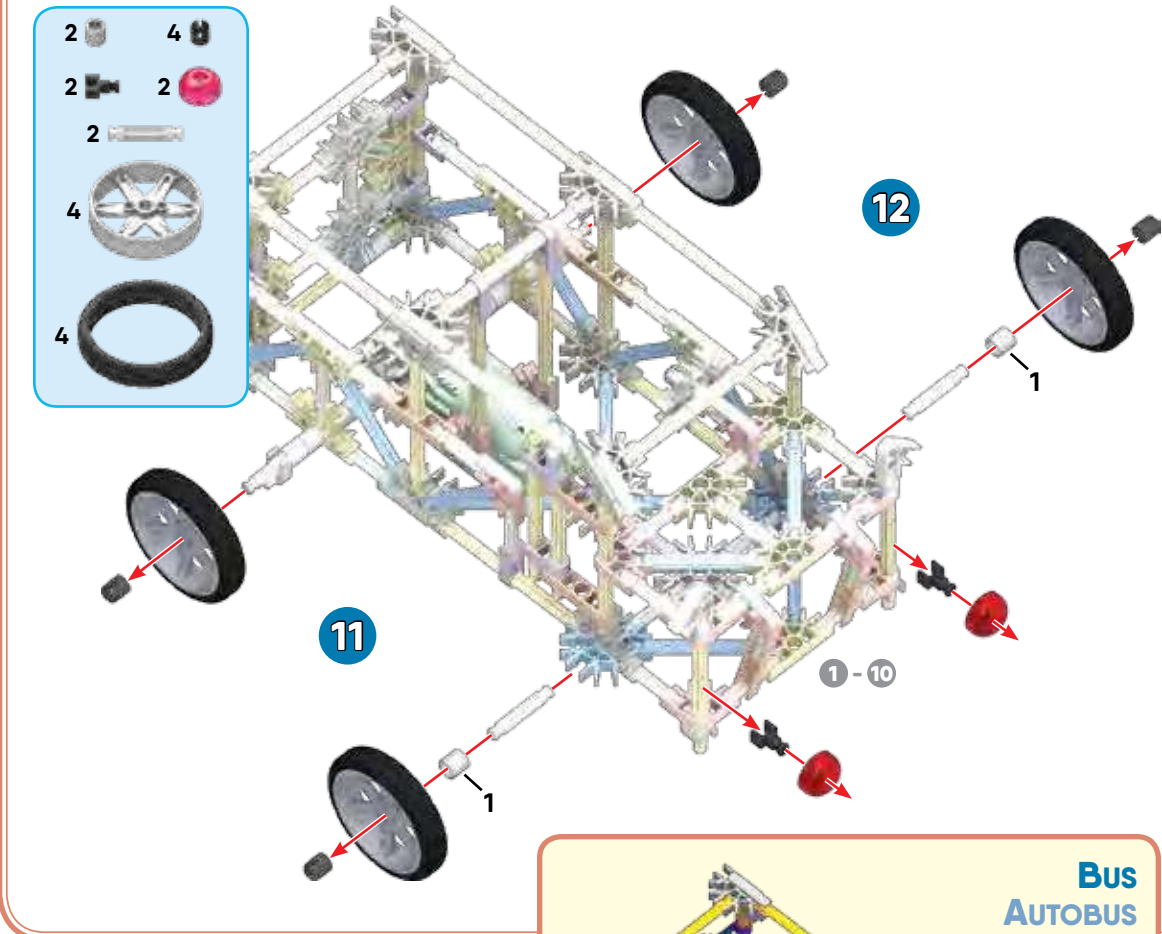

11

12

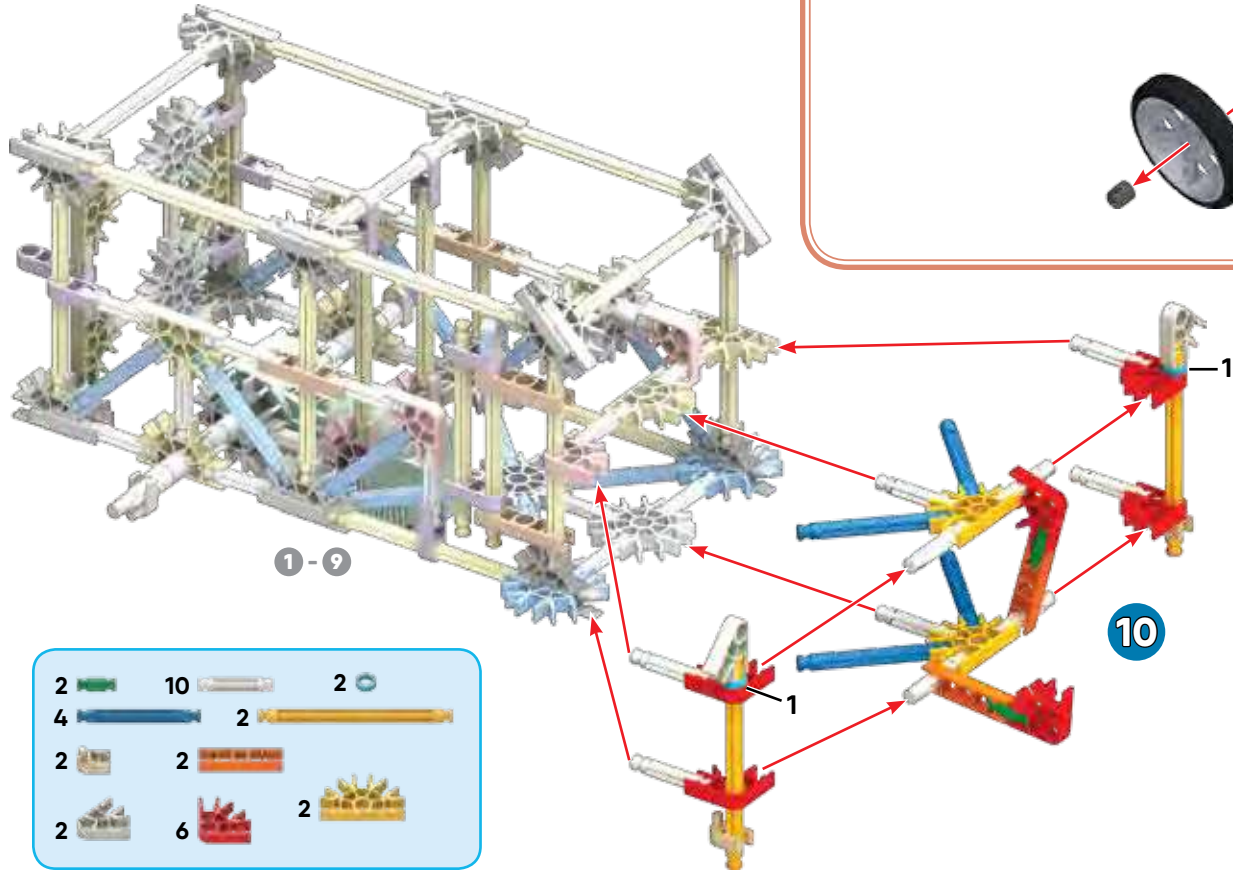

1 - 9

10



Bus
AUTOBUS

1 - 12

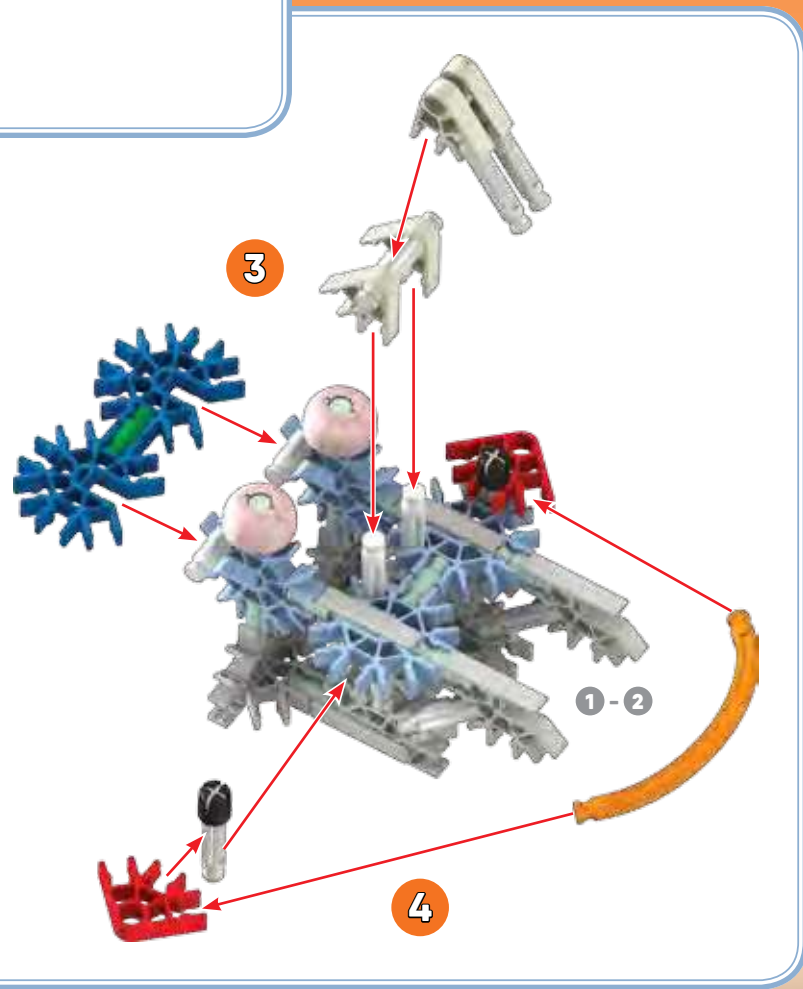
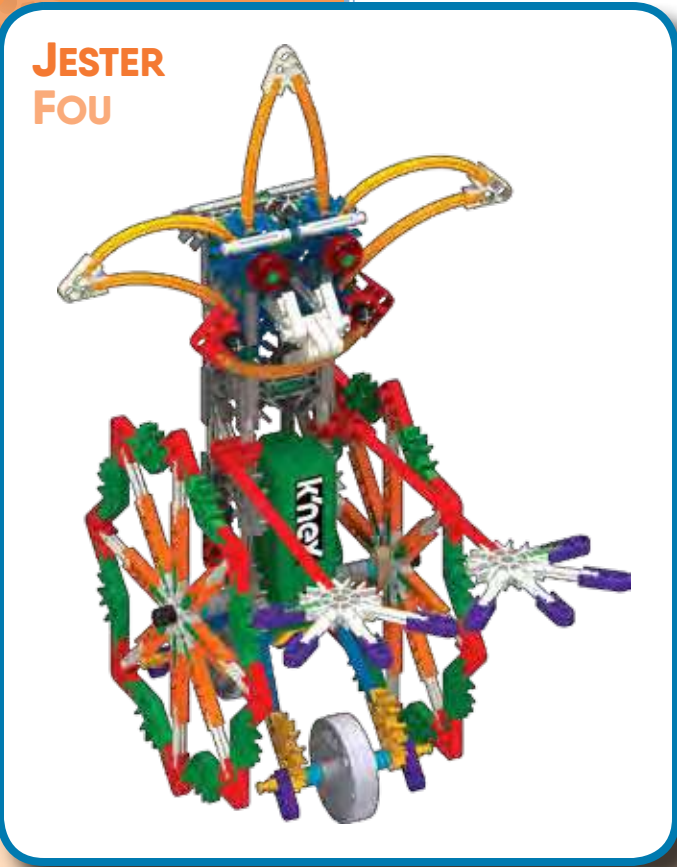
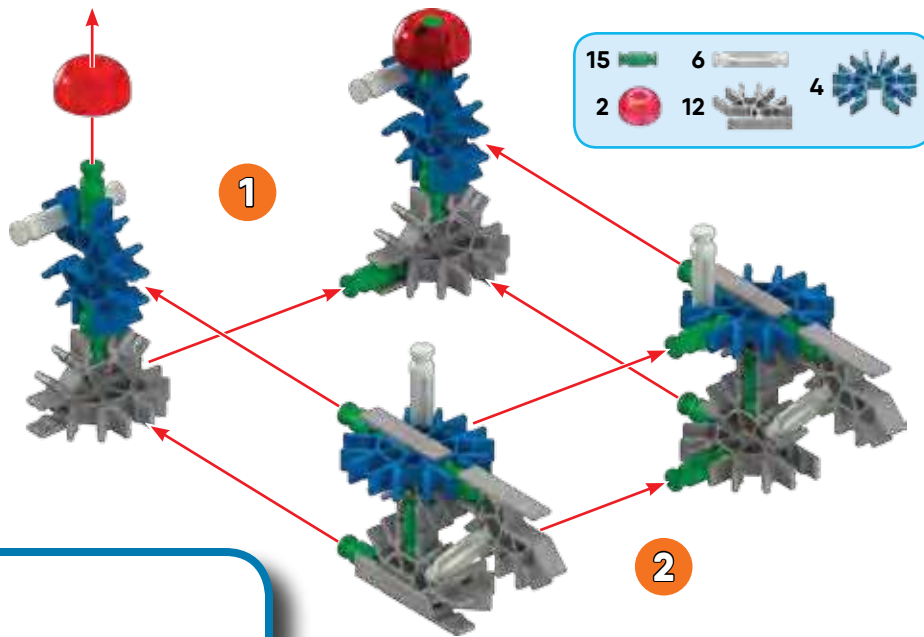

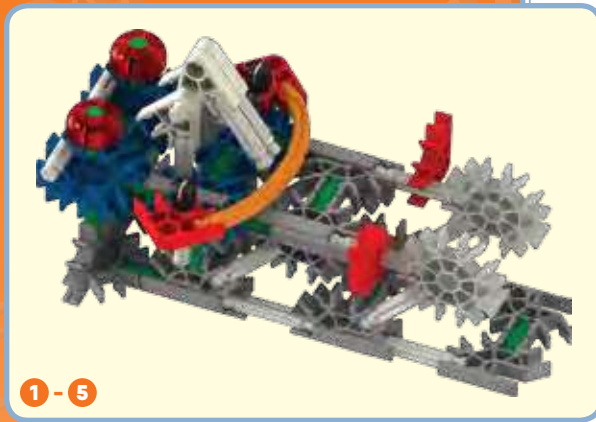

1 - 5

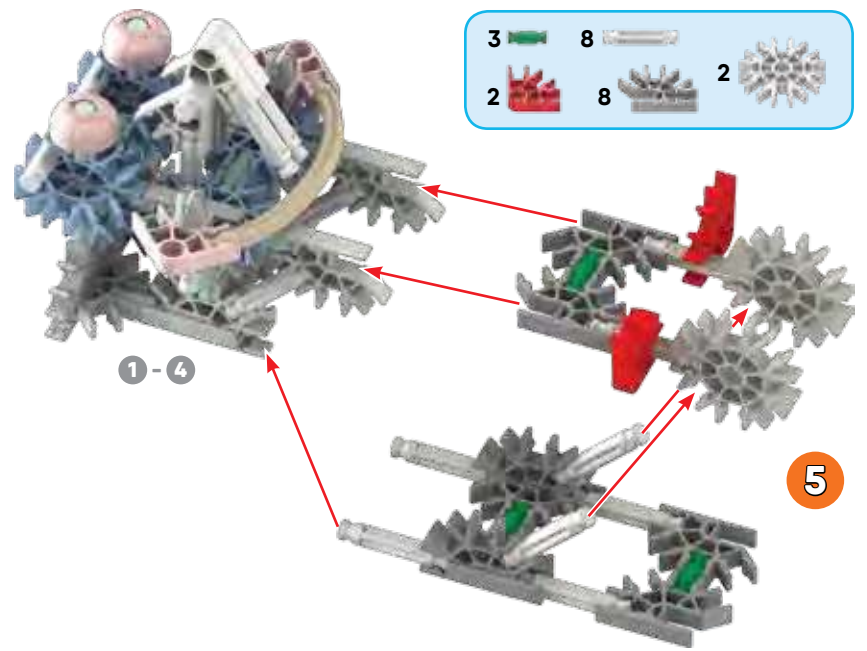

- | | | |
|---|---|---|
| 3 | 8 | 2 |
| 2 | 8 | 2 |

1 - 4

5

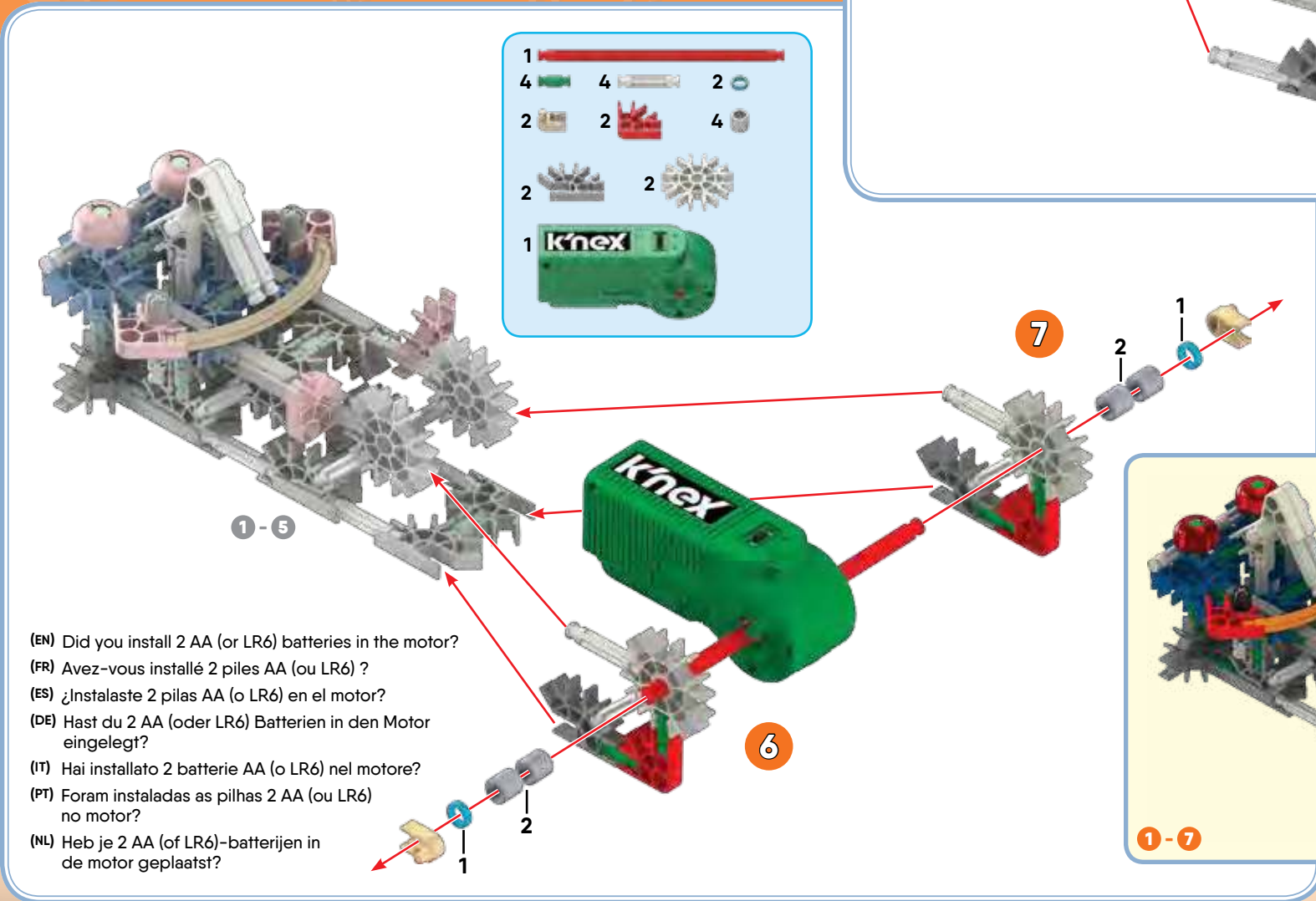

- | | | | |
|---|------|---|---|
| 1 | 4 | 4 | 2 |
| 2 | 2 | 2 | 4 |
| 2 | 2 | 2 | |
| 1 | Knex | | |

1 - 5

6

7



1 - 7

- (EN) Did you install 2 AA (or LR6) batteries in the motor?
- (FR) Avez-vous installé 2 piles AA (ou LR6) ?
- (ES) ¿Instalaste 2 pilas AA (o LR6) en el motor?
- (DE) Hast du 2 AA (oder LR6) Batterien in den Motor eingelegt?
- (IT) Hai installato 2 batterie AA (o LR6) nel motore?
- (PT) Foram instaladas as pilhas 2 AA (ou LR6) no motor?
- (NL) Heb je 2 AA (of LR6)-batterijen in de motor geplaatst?

x2

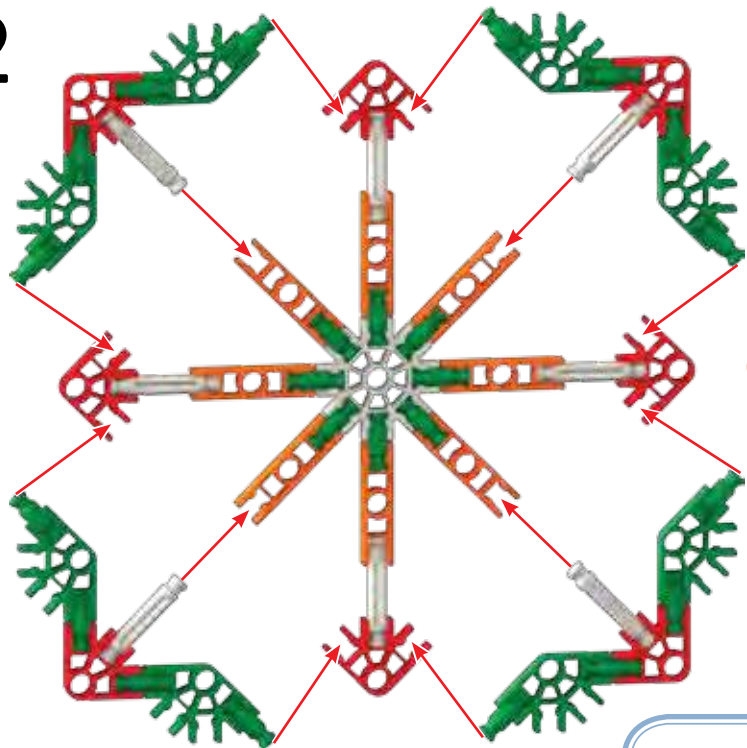

- 48 16
- 16 16 2

x2



8

8



1-10

2

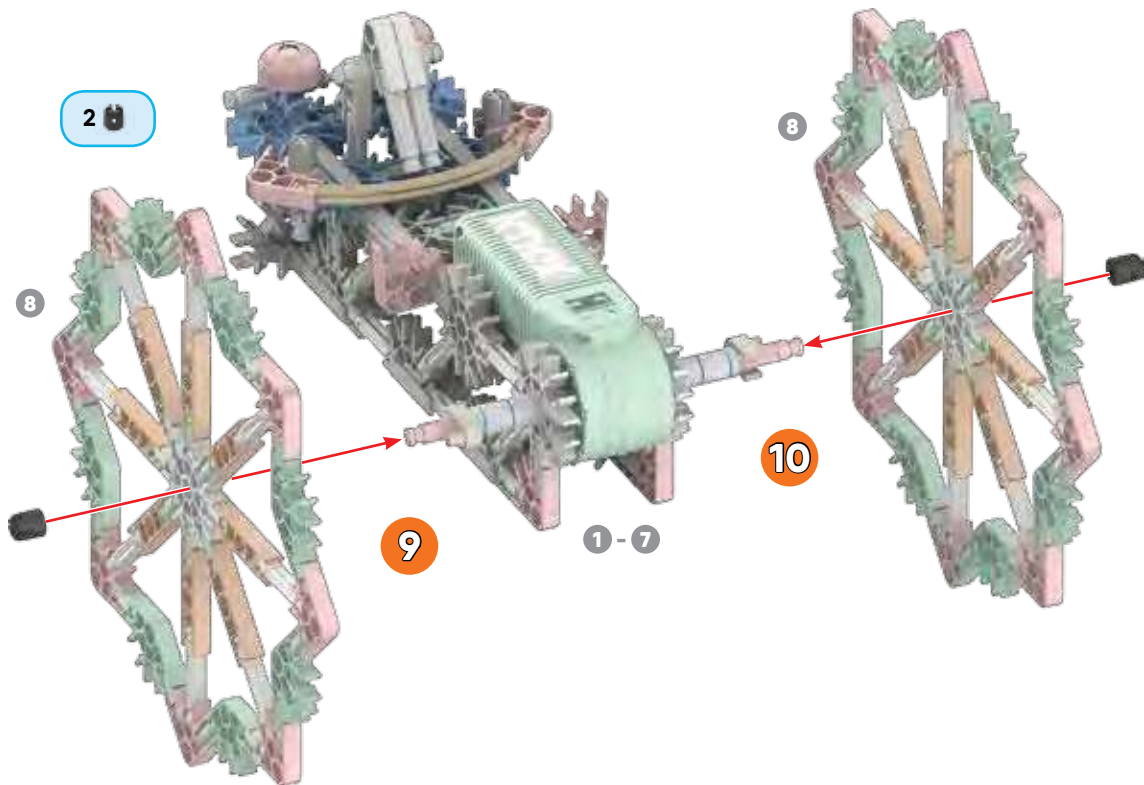

8

9

1-7

10

8



1 - 12



1 - 15

**JESTER
FOU**

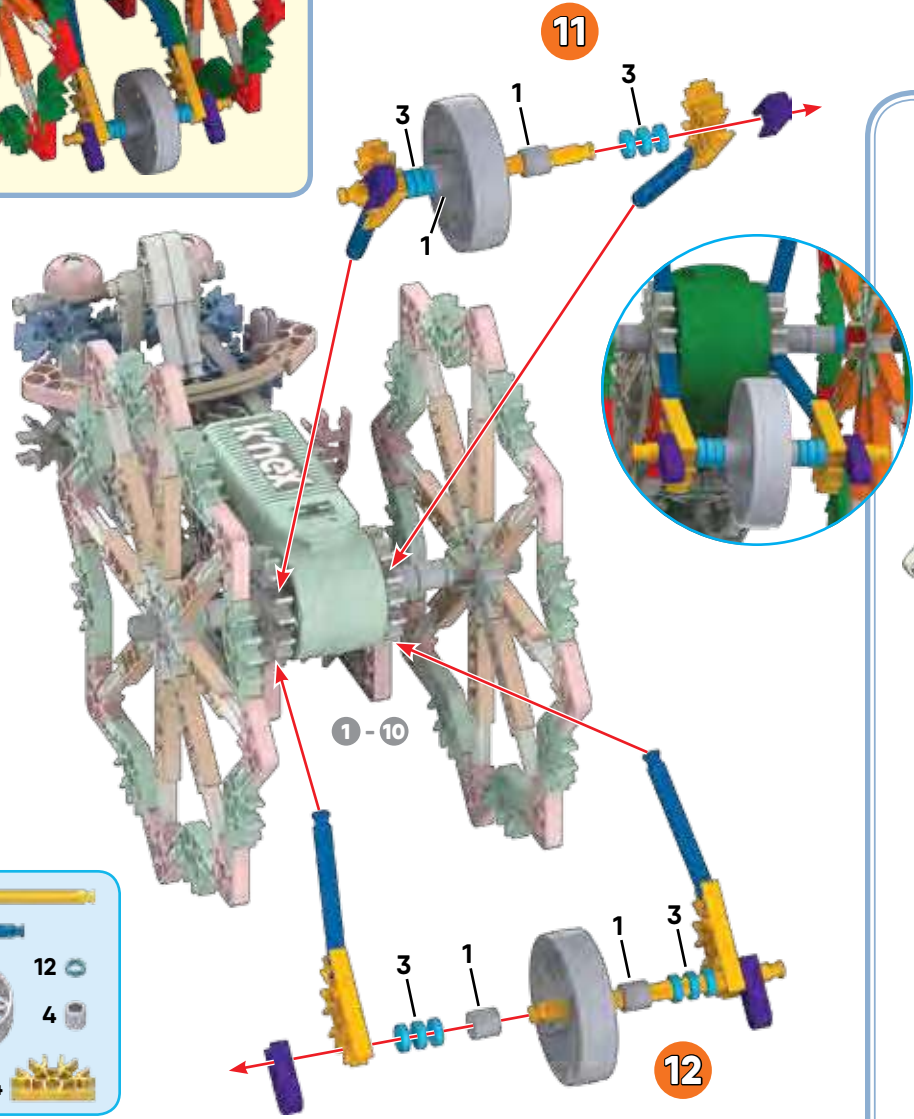

11

1 - 10

12

- 2
- 4
- 2
- 4
- 12
- 4
- 4
- 4

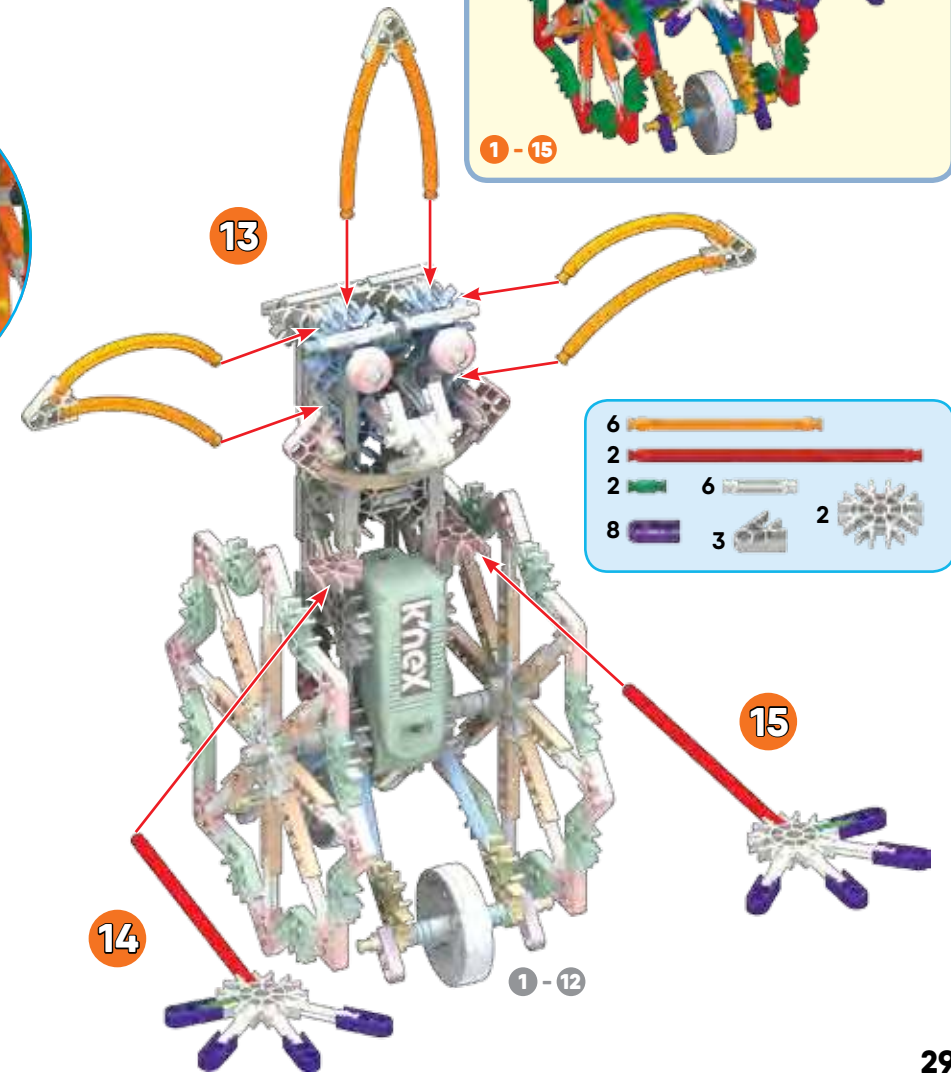

13

15

14

1 - 12

- 6
- 2
- 2
- 8
- 6
- 3
- 2

BASKETBALL GAME JEU DE BASKET-BALL

(EN) Did you install 2 AA (or LR6) batteries in the motor?
 (FR) Avez-vous installé 2 piles AA (ou LR6) ?
 (ES) ¿Instalaste 2 pilas AA (o LR6) en el motor?
 (DE) Hast du 2 AA (oder LR6) Batterien in den Motor eingelegt?
 (IT) Hai installato 2 batterie AA (o LR6) nel motore?
 (PT) Foram instaladas as pilhas 2 AA (ou LR6) no motor?
 (NL) Heb je 2 AA (of LR6)-batterijen in de motor geplaatst?

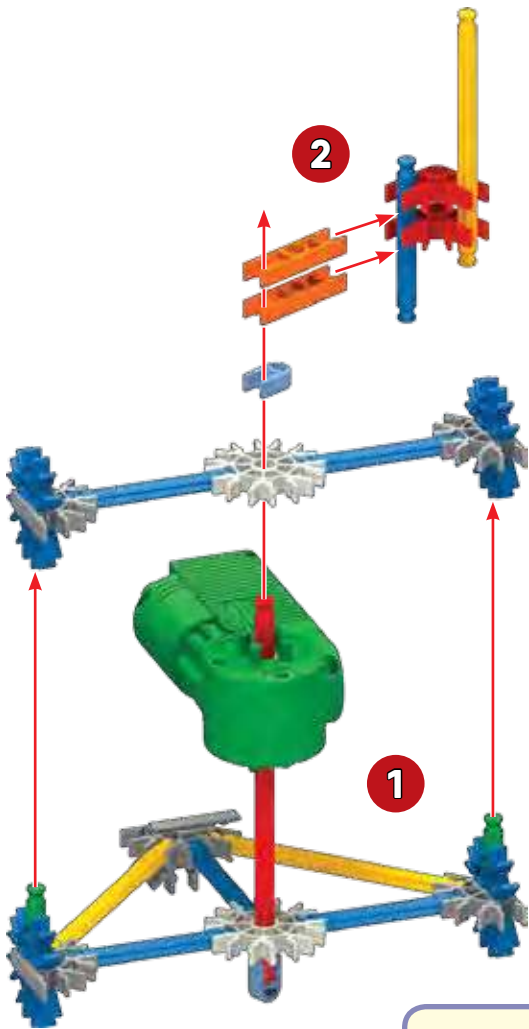

- 1
- 2 3
- 6 2
- 2 2 6
- 4 2
- 1

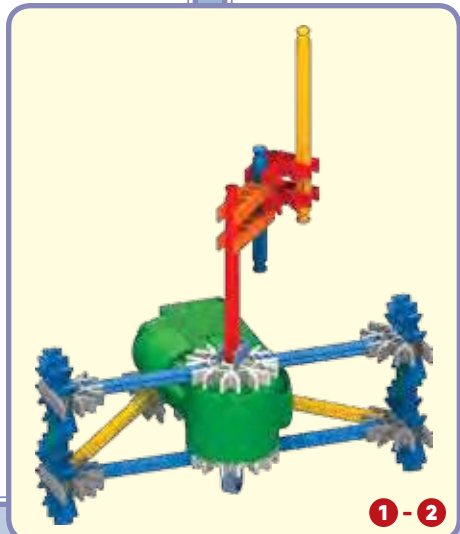
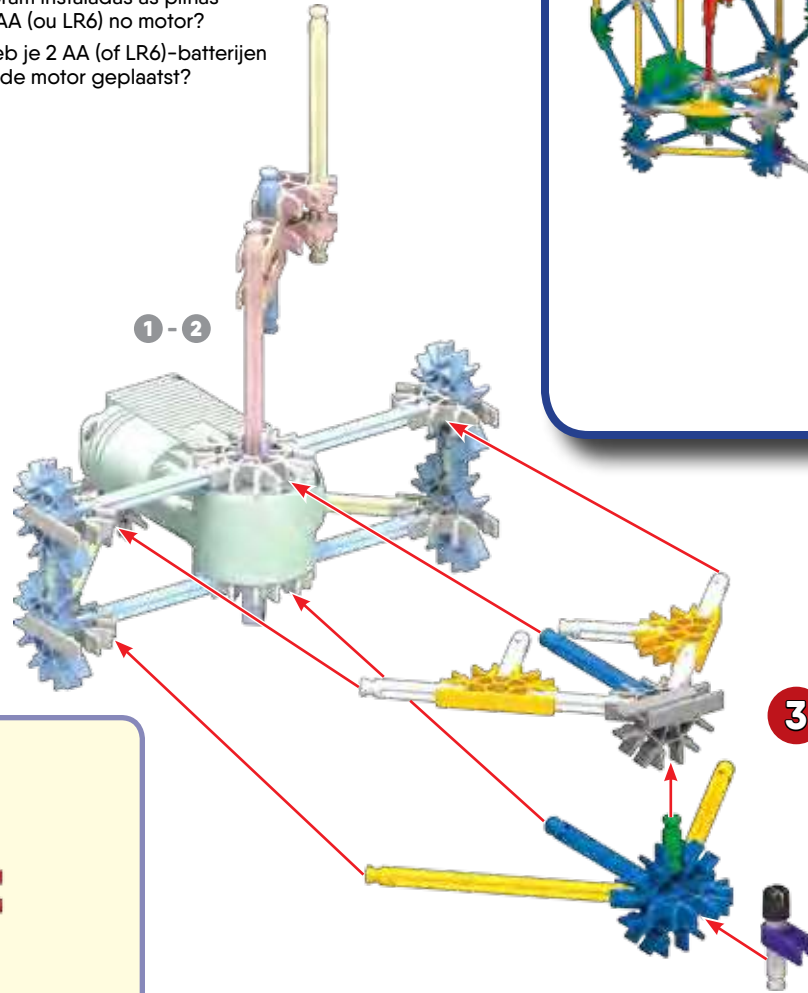

- 1 7 1 1
- 2 2
- 2 2 2

3

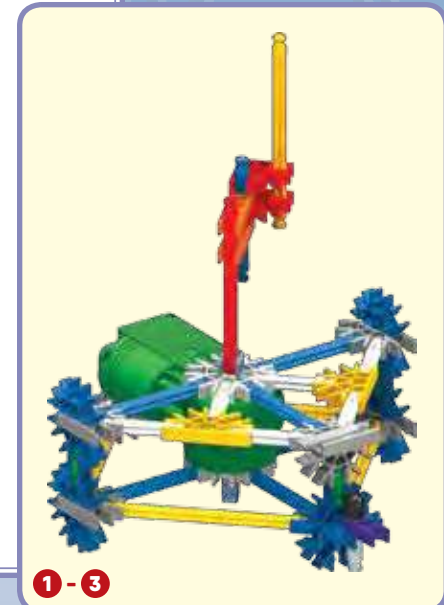

x2

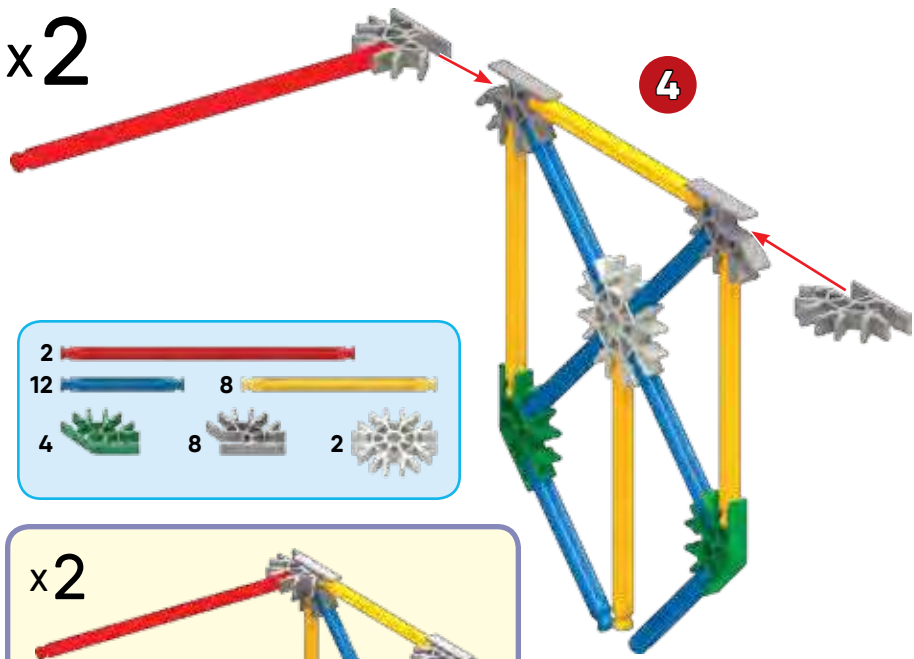

- 2
- 12
- 4
- 8
- 8
- 2

x2

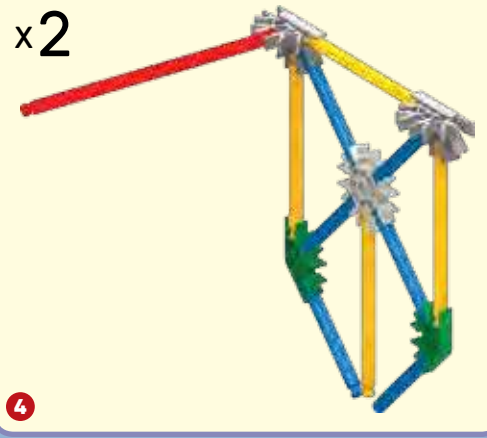

4



4-6

5

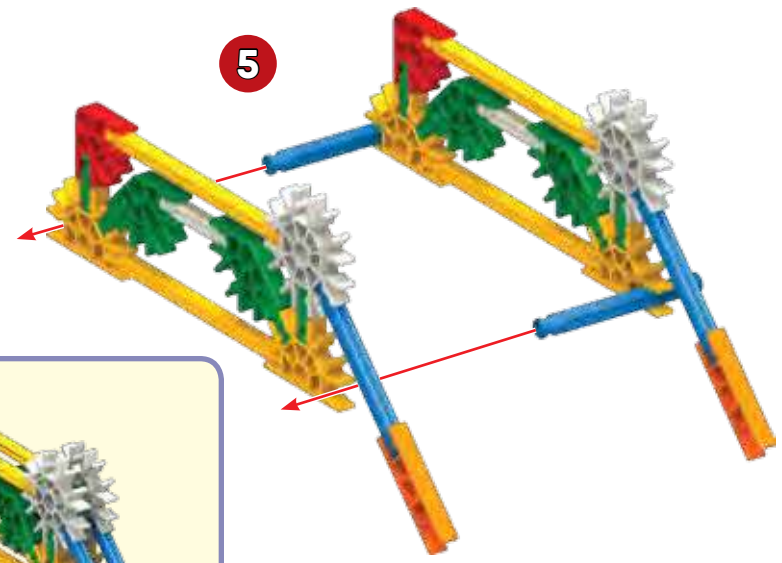

5

- 8
- 4
- 4
- 2
- 4
- 4
- 2
- 2
- 2

6

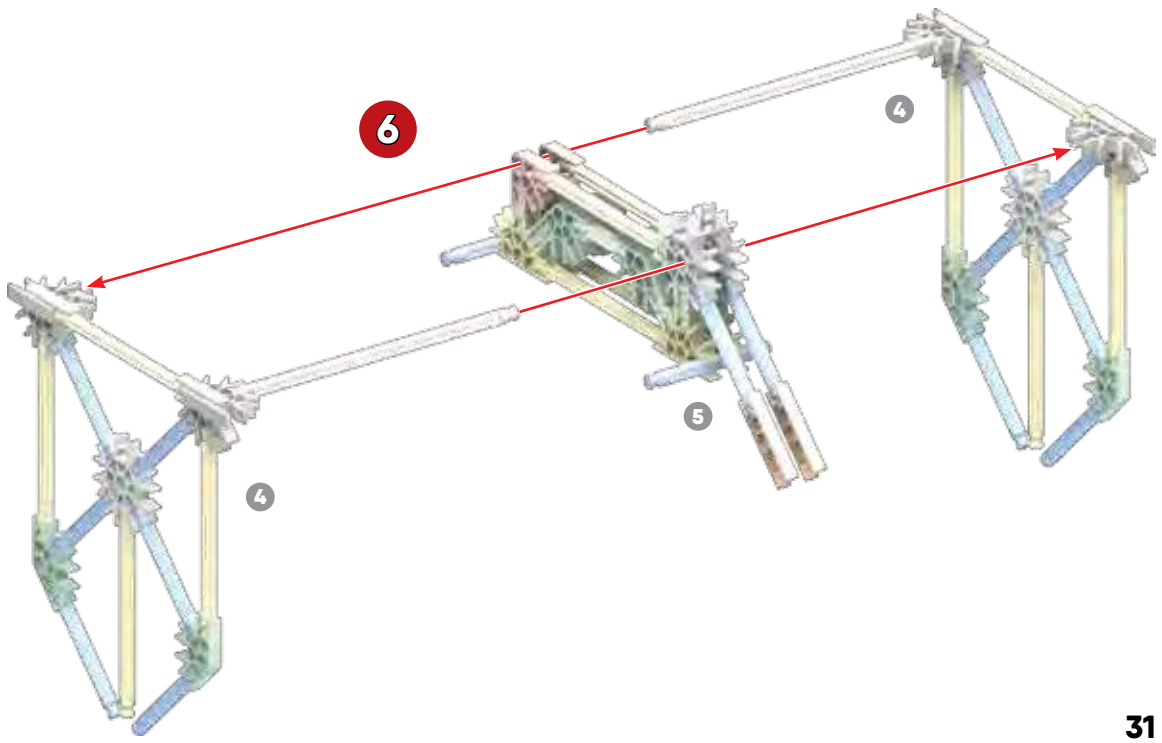

4

5

4

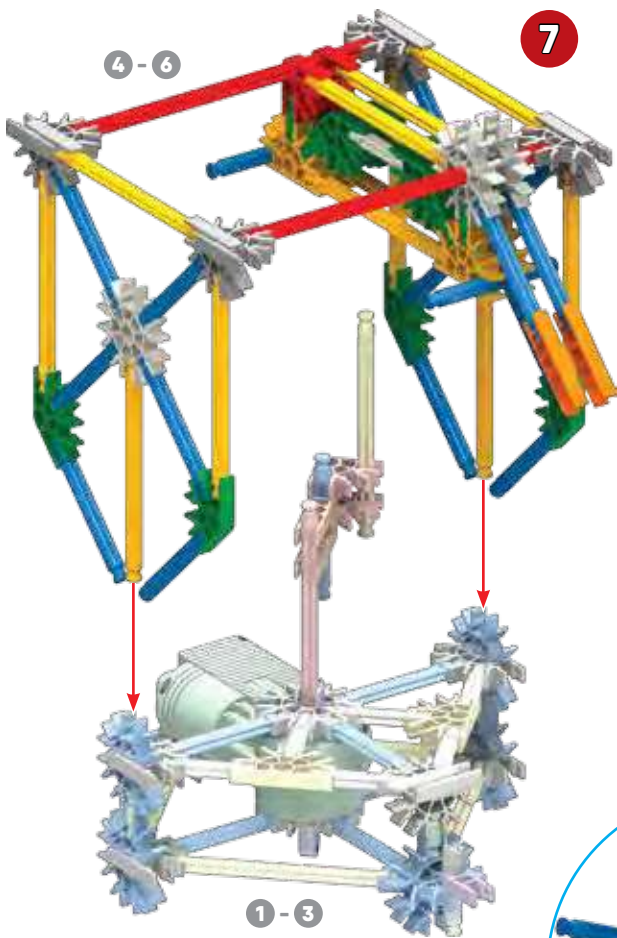

4-6

7

1-3

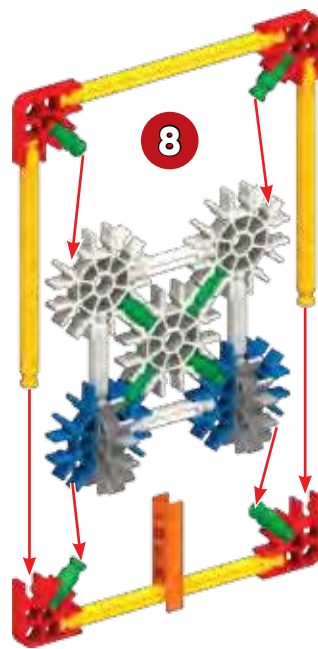

8

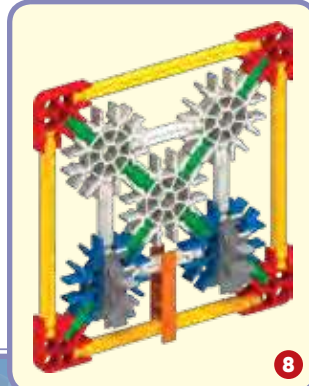
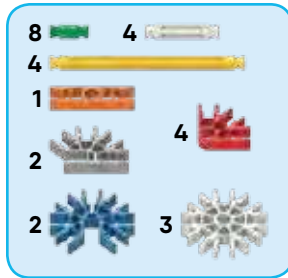

8

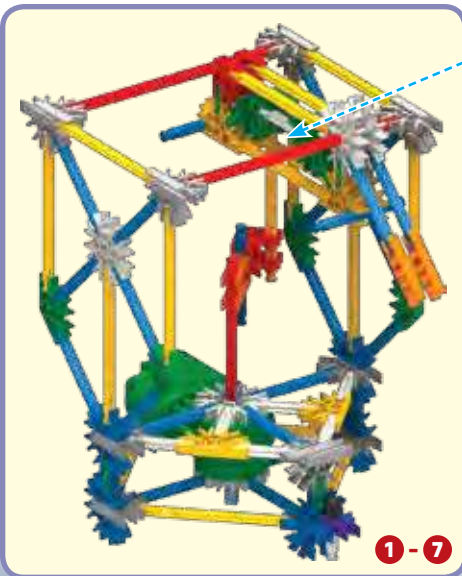

1-7

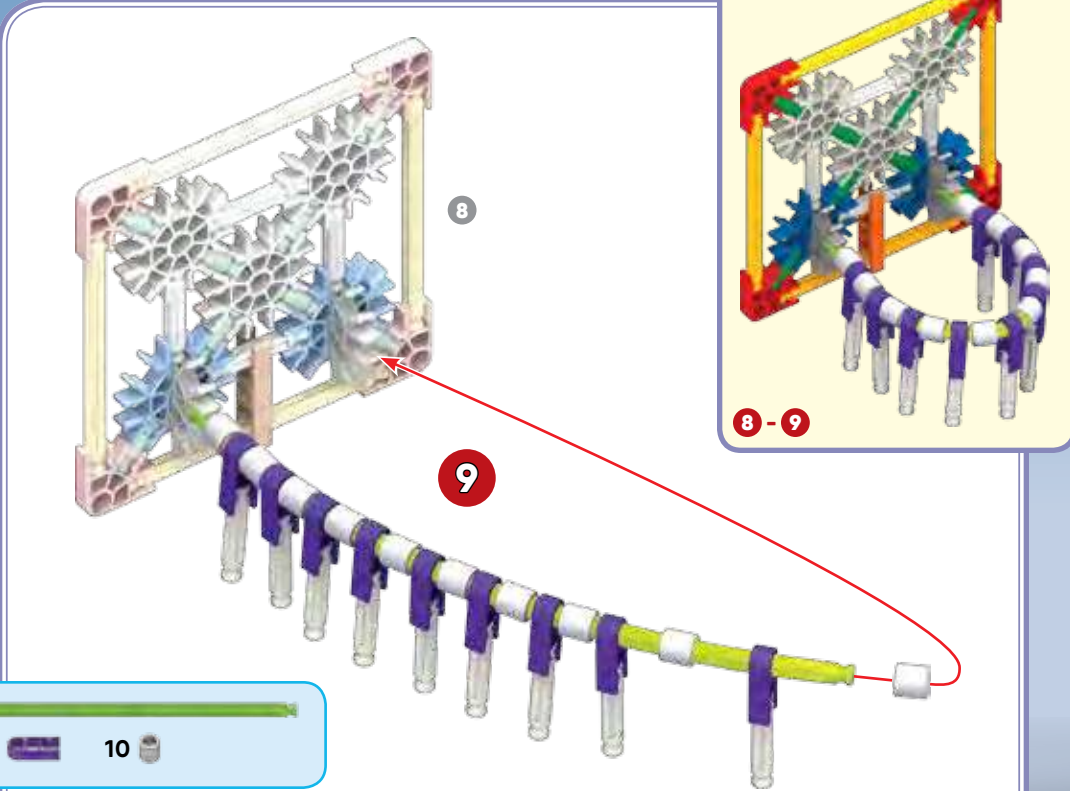

8

9

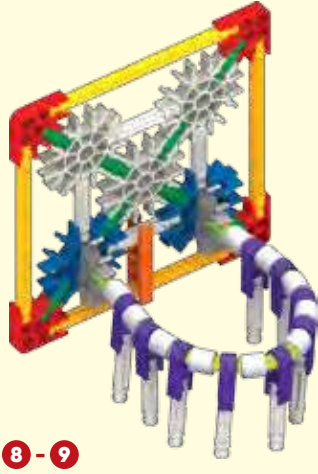

8-9

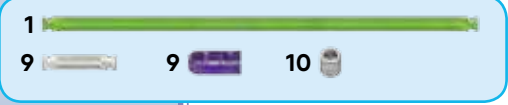

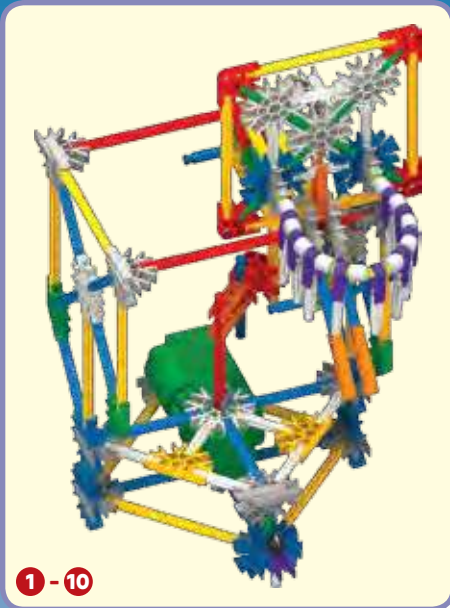

1 - 10

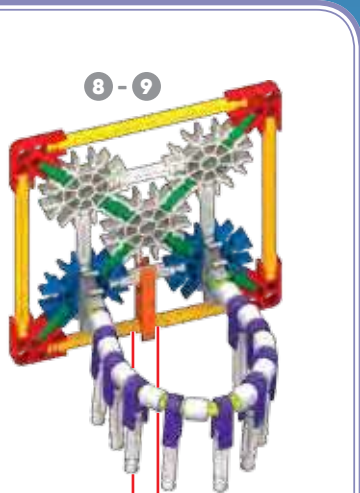

8 - 9

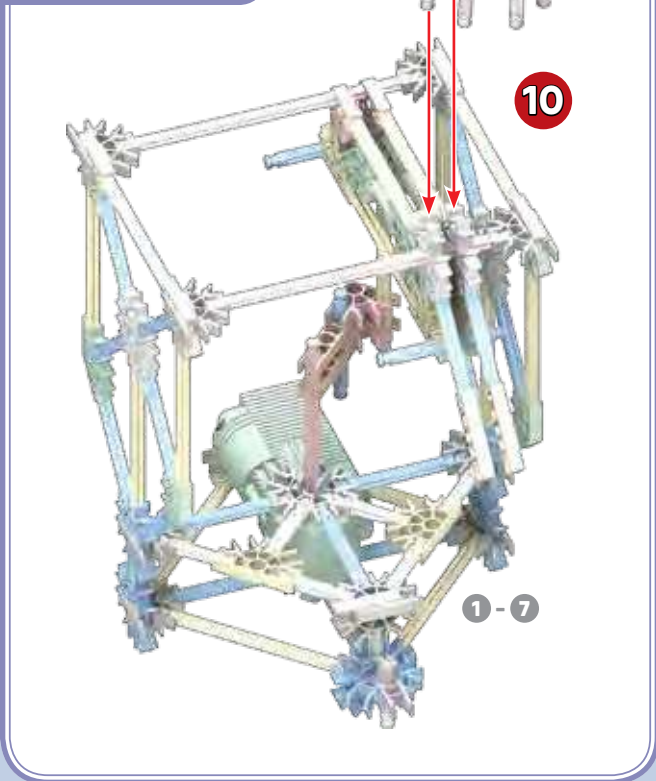

10

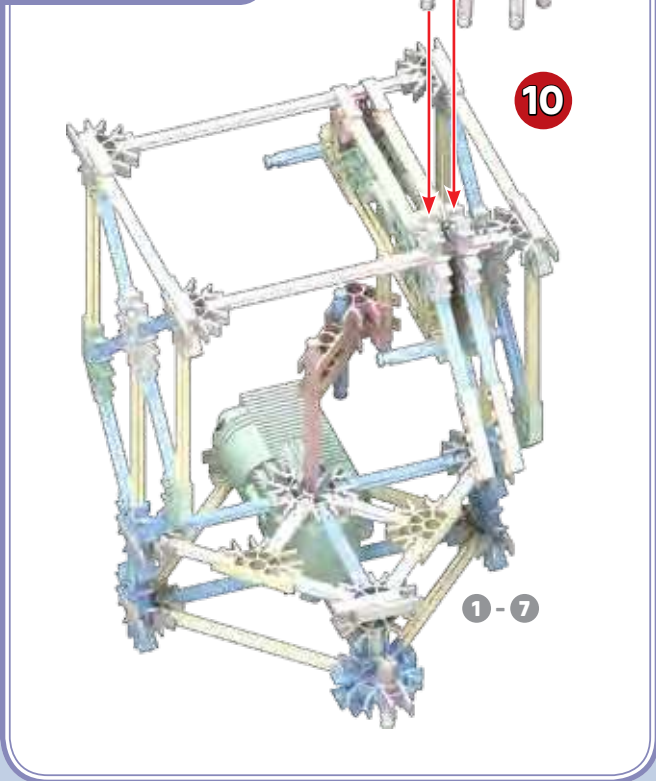

1 - 7

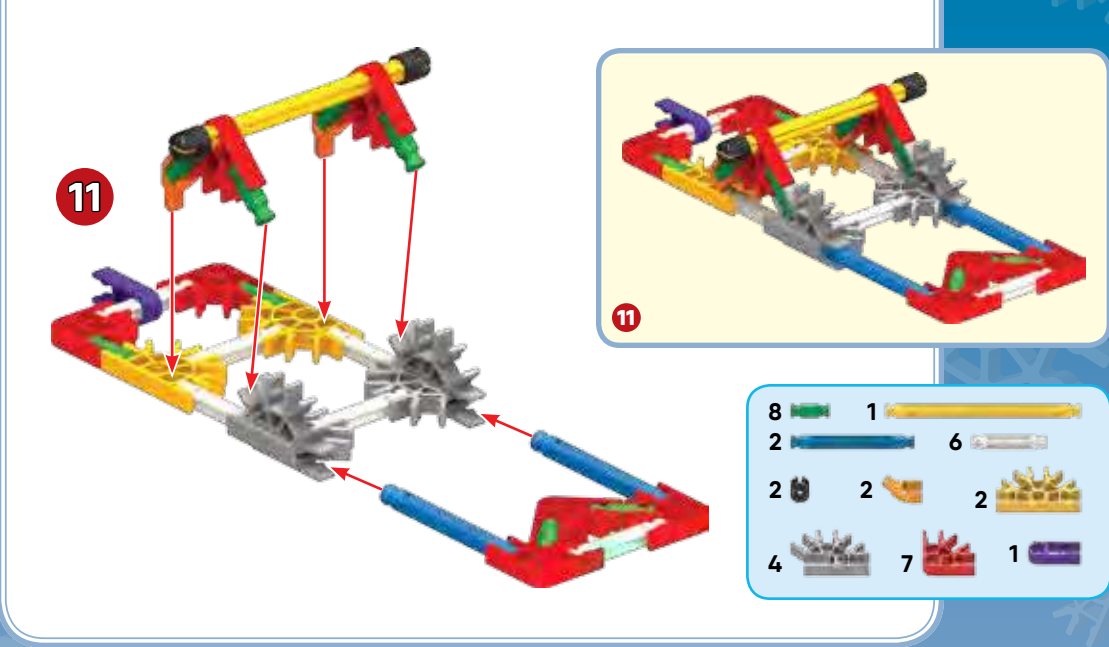

11



11

- | | | |
|---|---|---|
| 8 | 1 | 6 |
| 2 | 2 | 2 |
| 2 | 7 | 1 |
| 4 | | |



11 - 12

- | | | |
|---|---|---|
| 2 | 3 | |
| 2 | 2 | 3 |
| 2 | 2 | |
| 2 | | |

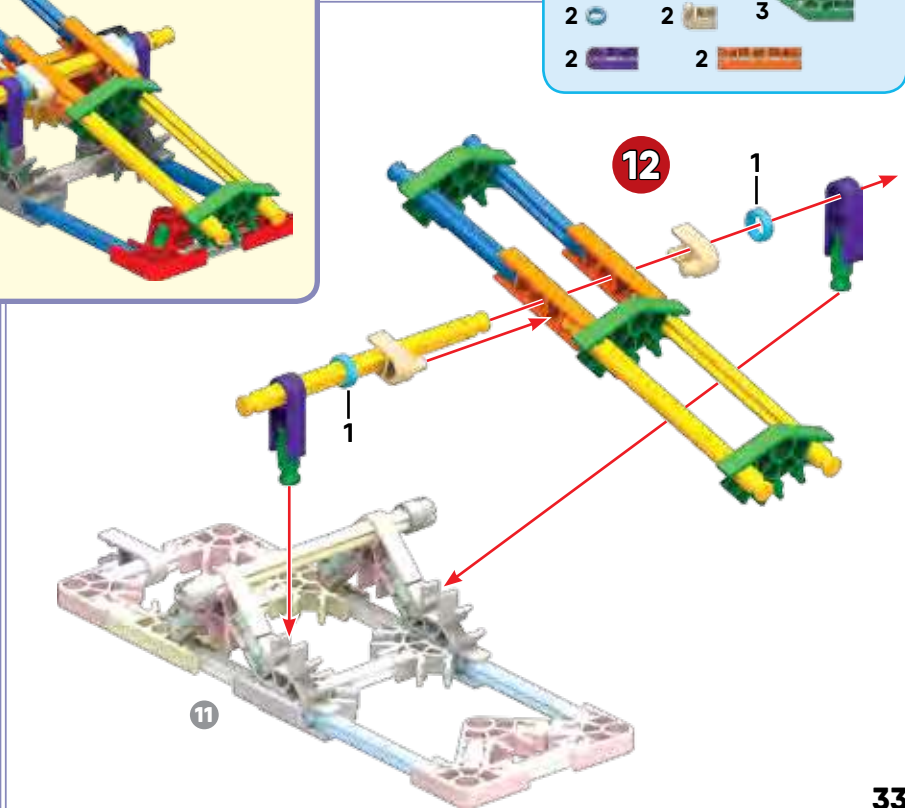

12

11

BASKETBALL GAME
JEU DE BASKET-BALL

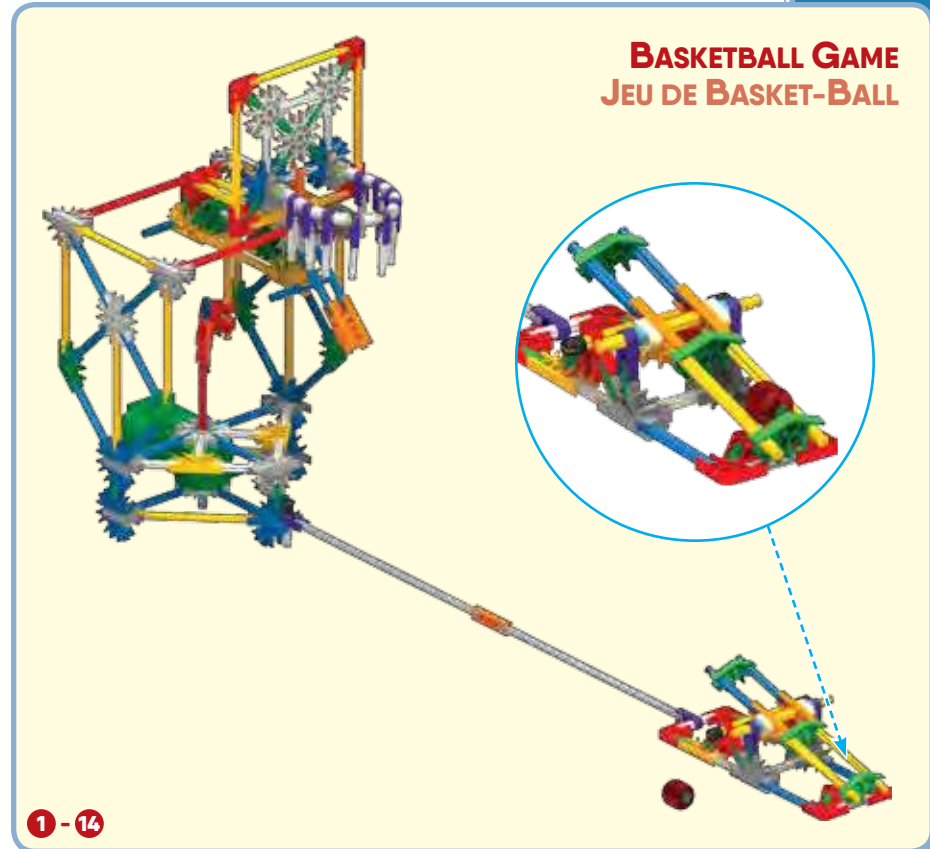
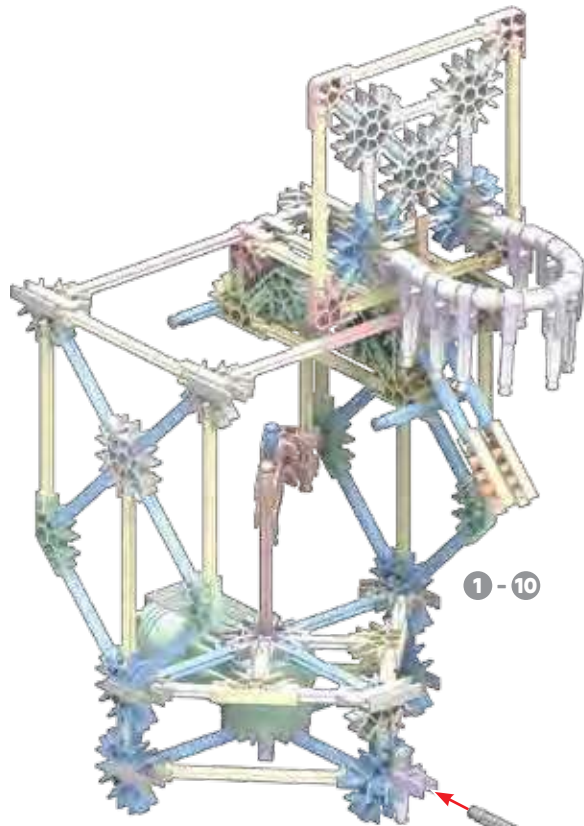

- 2
- 1
- 1
- 2

13

14

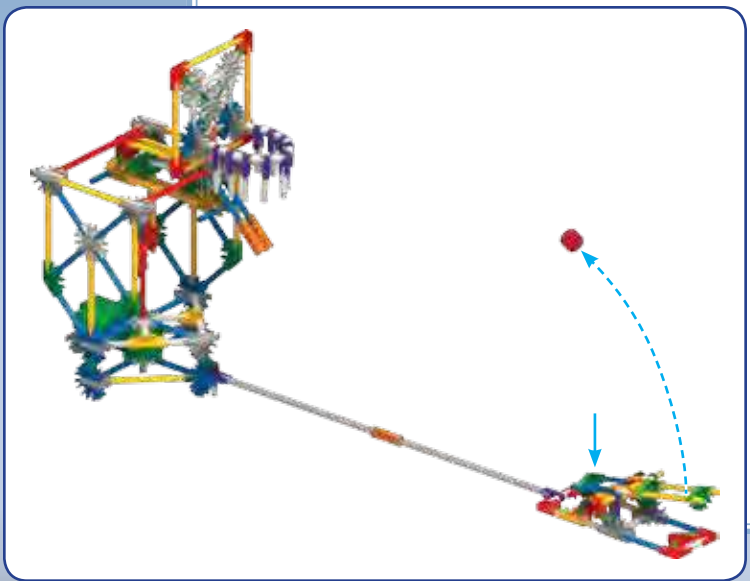
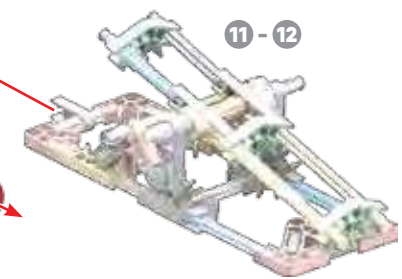

BUILDING IDEAS

For instructions of these models go to www.knex.com/instructions and enter code 23012.

IDÉES DE CONSTRUCTION

Pour les instructions de ces modèles vont à www.knex.com/instructions et entrez dans le code 23012.



BUILDING IDEAS

IDÉES DE CONSTRUCTION



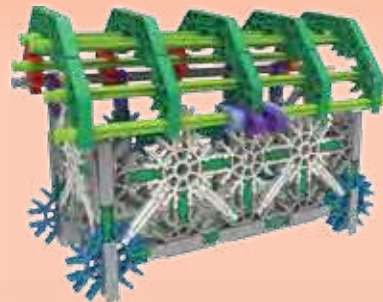
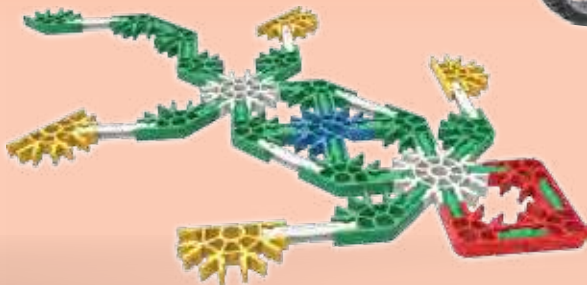
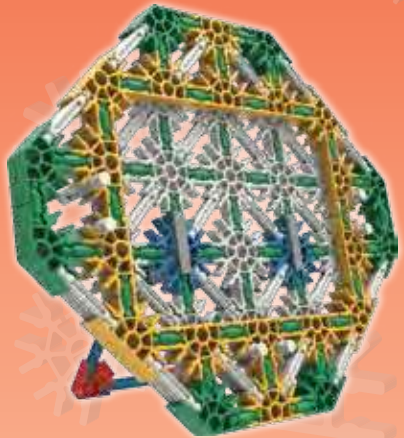

Básicos de Construcción

Empieza a construir

Cada K'NEX pieza tiene su propia forma y color. Mientras construyes, trata de colocar tu modelo en la misma dirección que se muestra en las instrucciones. Los colores desteñidos muestran que esta sección ya está construida.

Conectores

Usted puede deslizar estos conectores especiales juntos. Empuje firmemente hasta que oiga un "clic".

Espaciadores

Asegúrese de usar el color correcto y el número de espaciadores que se muestra en las instrucciones.

Información de la batería

Cómo insertar y quitar las pilas

Utilizar un pequeño destornillador principal Phillips para aflojar el tornillo y para quitar la cubierta de batería. Insertar 2 AA (LR6) baterías [No se incluyen] frescas en el compartimiento de batería con la polaridad correcta (+/-).

Instale las baterías antes de la construcción de modelo.

PRECAUCIÓN: Para evitar fugas en las pilas

- Inserte las pilas de acuerdo con los esquemas de polaridad (+/-).
- No mezcle diferentes tipos de pilas.
- No mezcle pilas alcalinas, estándar (carbón-zinc) o recargables (níquel-cadmio).
- No mezcle pilas viejas con nuevas. Se debe usar solamente pilas del mismo tipo, o las que se recomiendan como equivalentes.
- Siempre retire las pilas débiles o gastadas del producto; no forme cortocircuito en los puntos de intercambio.
- Retire todas las pilas si el juguete no se usará por mucho tiempo.

Consejos importantes

- Se recomiendan las pilas alcalinas.
- No se recomiendan las pilas recargables.
- Retire las pilas recargables del juguete antes de cargarlas; éstas deben ser cargadas solamente bajo la supervisión de un adulto.
- No se debe recargar las pilas que no son recargables.
- Mantenga los componentes sin polvo; no sumerja ni use en agua.
- No deseche las pilas en el fuego ya que pueden tener fugas, explotar y causar lesiones personales.



El contenedor de basura indica que este producto no puede desecharse con la basura doméstica debido a la presencia de sustancias peligrosas.

Para proteger la salud humana y el medio ambiente consultar con la agencia local para el consejo y las facilidades de reciclaje (2012/19/EU, solo Europa).

Lista de Piezas

Antes de empezar con la construcción, asegúrate de comparar las piezas en tu conjunto con la lista de las piezas aquí. Si faltan algunas, llámanos o escribenos siguiendo las instrucciones en la página trasera. Estamos aquí para ayudarte.

ADVERTENCIA: PELIGRO DE ASFIXIA – Piezas pequeñas. No para niños menores de 3 años.

PRECAUCIÓN: Mantén el cabello, los dedos, la cara y la ropa alejada de las piezas móviles.

IDEAS DE CONSTRUCCIÓN

Para obtener instrucciones de los estos modelos vaya a www.knex.com/instructions y entre en el código 23012.

Grundlegende Bauanleitungen für K'NEX

Los geht's mit dem Bauen

Jedes K'NEX Teil hat seine eigene Form und Farbe. Versuche, dein Modell beim Zusammenbauen so zu orientieren, dass es in die gleiche Richtung weist, wie es in den Anleitungen beschrieben und gezeigt wird. Blasse Farben weisen darauf hin, dass dieser Streckenabschnitt bereits zusammengebaut ist.

Verbindungsstücke

Verbindungsstücke haben besonders lange Schlitzte. Achte beim Aneinanderfügen dieser Teile darauf, dass du ein Klickgeräusch hörst.

Abstandsstücke

Achte darauf, die richtige Farbe und Anzahl von Abstandsstücken wie in der Anleitung gezeigt zu verwenden.

Informationen zu den Batterien

Anweisungen zum Einlegen und Entfernen der Batterien

Einen kleinen Kreuzkopfschraubenzieher benutzen, um die Schraube zu lösen und die Batterieabdeckung zu entfernen. 2 frische AA (oder LR6) Batterien [Nicht enthalten] in den Batterieraum mit der korrekten Polarität einsetzen (+/-).

Batterien vor dem Bau der Modelle einsetzen.

VORSICHT: Um ein Auslaufen der Batterien zu vermeiden

- Beim Einlegen der Batterien auf die korrekte Polarität (+/-), wie dargestellt, achten.
- Keine Batterien unterschiedlichen Typs mischen.
- Keine alkaline Batterien, Standard-Batterien (Kohle-Zink) oder wiederaufladbare Batterien (Nickel-Cadmium) mischen.
- Keine alten und neuen Batterien mischen. Nur Batterien des gleichen Typs oder empfohlenen äquivalenten Typs verwenden.
- Leere oder verbrauchte Batterien aus dem Spielzeug entfernen; darauf achten, dass die Pole der Batterie nicht kurzgeschlossen werden.
- Wenn das Spielzeug längere Zeit nicht verwendet werden soll, alle Batterien entfernen.

Wichtige Tipps

- Alkaline Batterien werden empfohlen.
- Wiederaufladbare Batterien sind nicht empfohlen.
- Bei Verwendung von wiederaufladbaren Batterien müssen diese aus dem Spielzeug entfernt werden, bevor sie wieder aufgeladen werden; das Wiederaufladen darf nur unter Aufsicht eines Erwachsenen stattfinden.
- Nichtwiederaufladbare Batterien dürfen nicht wieder aufgeladen werden.
- Die Komponenten von Staub freihalten; nicht in Wasser tauchen.
- Zu entsorgende Batterien nicht ins Feuer werfen; sie können auslaufen oder explodieren und Körperverletzungen verursachen.



Der Abfallbehälter zeigt an, dass dieses Produkt aufgrund von Gefahrstoffen nicht im normalen Hausmüll entsorgt werden kann.

Zum Schutz von Gesundheit und Umwelt kontaktiere bitte deine lokale Behörden für Recyclingtipps und -einrichtungen (2012/19/EU, nur Europa).

Teileliste

Bevor du mit dem Bauen anfängst, solltest du prüfen ob die Teile in deinem Bausatz mit denen auf dieser Teileliste übereinstimmen. Falls etwas fehlt, rufe uns an oder schreibe uns (siehe Rückseite). Wir sind für dich da!

ACHTUNG: ERSTICKUNGSGEFAHR – Kleinteile. Nicht geeignet für Kinder unter 3 Jahren.

VORSICHT: Haare, Finger, Gesicht und Kleidungsstücke nicht mit beweglichen Teilen in Berührung kommen lassen.

BAUVORSCHLÄGE

Für Anweisungen dieser Modelle gehen sie zu www.knex.com/instructions und geben sie Code 23012 ein.

Istruzioni di base per costruire con K'NEX

Comincia a costruire

Ogni K'NEX pezzo ha una sua forma e un suo colore. Cerca di tenere il modello nella stessa direzione della figura e in tal modo sarà più semplice allegare i pezzi nei posti giusti. I colori spenti ti dicono che questa sezione è già stata costruita.

Connettori

È molto importante posizionare i connettori in una specifica direzione. Spingi con forza fino ad udire un clic.

Spaziatori

Accertati che usate il colore corretto e il numero di spaziatori mostrati nell' istruzioni.

Informazioni sulle batterie

Come inserire e rimuovere le batterie

Utilizzare un piccolo cacciavite phillips per allentare la vite e per rimuovere la copertura di batteria. Inserire 2 AA (o LR6) batterie [Non incluse] fresche nello scompartimento di batteria con la polarità corretta (+/-). Installare le batterie prima di modelli di edifici.

ATTENZIONE: Come evitare perdite delle batterie

- Inserire le batterie con la polarità corretta (+/-) come illustrato.
- Non mischiare tipi diversi di batterie.
- Non mischiare alcaline, standard (carbonio-zinco) e ricaricabili (nichel-cadmio).
- Non mischiare insieme batterie nuove e vecchie. Usare sempre batterie raccomandate dello stesso tipo o di tipo equivalente.
- Rimuovere sempre batterie quasi scariche o completamente scariche dal prodotto; non causare corto circuito ai terminali di alimentazione.
- Non gettare le batterie nel fuoco, poiché potrebbero perdere o esplodere e causare lesioni.

Consigli importanti

- Si raccomanda l'uso di batterie alcaline.
- Non si raccomanda l'uso di batterie ricaricabili.
- Rimuovere le batterie ricaricabili dal giocattolo prima della carica: devono essere caricate solo sotto la supervisione di un adulto.
- Le batterie non ricaricabili non devono essere ricaricate.
- Mantenere i componenti privi di polvere; non immergere o usare in acqua.
- Rimuovere tutte le batterie se il giocattolo non verrà usato per un lungo periodo di tempo.



Il bidone della spazzatura indica che questo prodotto non si può buttare via con i rifiuti domestici a causa della presenza di sostanze pericolose.

Per proteggere la salute umana e l'ambiente, devi controllare con la tua autorità locale per consigli e impianti di riciclaggio (2012/19/EU, solo in Europa).

Elenco delle parti

Prima di cominciare a costruire, accertati di confrontare le parti che sono nel tuo set con l'elenco delle parti qui. Se ne manca una chiamaci o scrivici usando le informazioni che sono nella retrocopertina. Noi siamo qui per aiutarvi!

AVVISO: PERICOLO DI SOFFOCARE – Pezzi piccoli. Non adatto per bambini sotto 3 anni.

ATTENZIONE: Tenere i capelli, le dita, il viso e i vestiti lontano da tutte le parti in movimento.

IDEE DI COSTRUZIONE

Per istruzioni di questi modelli vai a www.knex.com/instructions inserire il codice **23012**.

(PT) Português

(Página 2)

Pontos básicos para a construção K'NEX

Inicia a construção

Cada K'NEX peça tem a sua própria forma definida e cor. Enquanto estás a montar as peças, tenta manter o teu modelo na mesma direcção, conforme mostrado na ilustração, para assim conectar as peças correctamente. As cores desbotadas indicam que esta secção já está construído.

Conectores

Empurre estes conectores especiais juntos firmemente até ouvir um "clique".

Espaçadores

Existirão certos pontos no teu modelo que necessitam a colocação de espaçadores. Certifique-se de contar com cuidado.

(Página 3)

Informações sobre as pilhas

Como introduzir e remover baterias

Usar uma chave de fenda principal pequena de Phillips para afrouxar o parafuso e para remover a tampa de bateria. Introduzir 2 AA (ou LR6) baterias [Não estão incluídas] frescas no compartimento de bateria com a polaridade correcta (+/-).

Instale baterias antes modelos de construção.

CUIDADO: Para evitar fugas das pilhas

- Introduza as pilhas com a polaridade correcta (+/-), conforme se mostra.
- Não misture tipos diferentes de pilhas.
- Não misture pilhas alcalinas, padrão (carbono-zinco) ou pilhas recarregáveis (níquel-cádmio).
- Não combine pilhas usadas com pilhas novas. Apenas pilhas do mesmo tipo ou equivalentes ao tipo recomendado.
- Retire sempre as pilhas fracas ou gastas do produto; não provoque um curto-circuito nos terminais de alimentação.
- Retire todas as pilhas do brinquedo se não tencionar usá-lo durante um longo período de tempo.

Conselhos importantes

- Recomenda se o uso de pilhas alcalinas.
- Não se recomenda o uso de pilhas recarregáveis.
- Retire as pilhas recarregáveis do brinquedo antes de as carregar; estas pilhas devem ser recarregadas apenas sob vigilância de adultos.
- As pilhas não recarregáveis não devem ser carregadas.
- Mantenha os componentes livres de poeiras; não mergulhe em água nem use água.
- Não elimine as pilhas queimando-as; estas podem apresentar fugas ou explodir causando lesões.



O caixote do lixo indica que este produto não pode ser descartado junto com o lixo doméstico devido à presença de substâncias perigosas.

Para proteger a saúde humana e o meio ambiente verifique a sua autoridade local para reciclagem conselho e instalações (2012/19/EU, somente na Europa).

(Página 4)

Lista de peças

Antes de iniciares a construção, certifica-te de que comparas as peças do teu conjunto com a lista das peças aqui. Se está desaparecido uma peça telefona ou escreve-nos usando as informações indicadas na contracapa. Estamos aqui para te ajudar!

AVISO: PERIGO DE SUFOCAÇÃO – Peças pequenas. Não se destina a crianças com menos de 3 anos de idade.

CUIDADO: Mantém o cabelo, os dedos, a cara e a roupa afastados de todas as peças móveis.

IDEIAS DE CONSTRUÇÃO

Para obter instruções destes modelos vá em www.knex.com/instructions e digite o código **23012**.

(NL) Nederlands

(Bladzijde 2)

Basisstappen voor K'NEX bouwen

Begin te bouwen

Elk K'NEX stuk heeft zijn eigen vorm en kleur. Tracht je model in dezelfde richting te plaatsen als de aanwijzingen terwijl je bouwt en monteert. De vervaagde kleuren duiden aan dat dit deel reeds is opgebouwd.

Verbindingsstukken

Duw deze speciale verbindingstukken stevig tegen elkaar aan tot je een 'klik' hoort.

Afstandhouders

Zorg dat je het juiste en kleur aantal afstandhouders gebruikt.

(Bladzijde 3)

Informatie over Batterijen

Batterijen plaatsen en verwijderen

Gebruik een kleine kruiskopschroevendraaier om de schroef van het klepje los te draaien. Plaats 2 nieuwe AA-batterijen (LR6) [Niet inbegrepen] in het batterijvak en let daarbij op de polariteit (+/-), zoals hier wordt getoond. Plaats de batterijen voordat je een model bouwt.

WAARSCHUWING: Voorkom lekkende batterijen

- Let op de polariteit bij het plaatsen van batterijen (+/-), zoals wordt getoond.
- Gebruik geen verschillende typen batterijen samen.
- Gebruik geen alkaline, gewone (koolstof-zink) of oplaadbare (nikkel-cadmium) batterijen samen.
- Gebruik geen nieuwe en gebruikte batterijen samen. Gebruik uitsluitend batterijen van het aanbevolen type of van een gelijkwaardig type.
- Verwijder lege batterijen uit het speelgoed. Vermijd kortsluiting.
- Verwijder de batterijen uit het speelgoed als het langere tijd niet wordt gebruikt.

Belangrijke tips

- Alkalinebatterijen worden aanbevolen.
- Oplaadbare batterijen worden niet aanbevolen.
- Verwijder oplaadbare batterijen voordat u ze oplaadt. Het opladen mag uitsluitend gebeuren onder toezicht van een volwassene.
- Niet-oplaadbare batterijen mogen niet worden opgeladen.
- Houd de onderdelen stofvrij. Niet in water dompelen of gebruiken.
- Gooi batterijen niet in het vuur. Ze kunnen lekken of exploderen en schade veroorzaken.



Het pictogram van een verrijdbare vuilnisbak geeft weer dat dit product niet samen met het gewone huis-, tuin- en keukenafval mag worden weggegooid, omdat het gevaarlijke substanties bevat. Bescherm gezondheid en milieu en vraag advies aan de plaatselijke afvalverwerking-sdienst over hoe en waar u producten kunt recyclen (2012/19/EU, alleen Europa).

(Bladzijde 4)

Lijst met onderdelen

Zorg ervoor dat de onderdelen te vergelijken met de onderdelen hier op te sommen. Als er iets is ontbreekt, bel of schrijf ons gebruik van de informatie op de achterkant. Wij zijn hier om u te helpen!

WAARSCHUWING: INSLIKKINGSGEVAAR – Kleine onderdelen. Niet geschikt voor kinderen jonger dan 3 jaar.

LET OP: Hou het haar, de vingers, het gezicht en kledij verwijderd van alle bewegende onderdelen.

(Bladzijde 35)

BOUWIDEËN

Voor instructies van deze modellen naar www.knex.com/instructions en vul de code **23012**.



POWER & PLAY
Motorized Building Set

SUPER BOX AVEC MOTEUR
Jeu de construction motorisé

knex.com

@knexbrands

facebook.com/knexus



SCIENCE/SCIENCE
TECHNOLOGY/TECNOLOGIE
ENGINEERING/INGÉNIERIE
ART & DESIGN/CONCEPTION & D'ART
MATH/MATHÉMATIQUES*

BUILDER BASICS**
Building Set

ELÉMENTS ESSENTIELS DE CONSTRUCTION
Jeu de construction

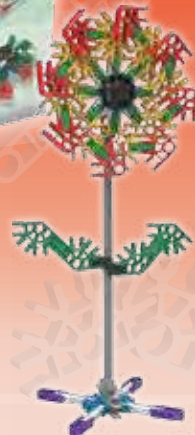

STEALTH PLANE**
Building Set
AVION FURTIF
Jeu de construction



MOTORCYCLE**
Building Set
MOTO
Jeu de construction



ROCKET CAR**
Building Set
VOITURE-FUSÉE
Jeu de construction



*Juego inspirado
Inspiriertes Spiel
Ha ispirato il gioco
Inspirou o jogo
Geïnspireerd spel

Ciencia/Wissenschaft/
Scienza/Ciência/Wetenschap
Tecnologia/Technologie/
Tecnologia/Tecnologia/
Technologie
Ingeniería/Ingenieurwesen/
Ingegneria/Engenharia/
Bouwkunde
Arte Y Diseño/Kunstdesign/
Arte E Design/Design de arte/
kunst En Ontwerp
Matemáticas/Mathematik/
Matemática/Matemática/
Wiskunde

**Sold separately
Vendus séparément
Se venden por separado
Separat erhältlich
Venduti separatamente
Vendidos separadamente
Afzonderlijk verkrijgbaar

©2017 K'NEX Limited Partnership Group, P.O. Box 700, Hatfield, PA 19440-0700; 1-800-KID-KNEX (USA/Canada/États-Unis/EE.UU.); email@knex.com; knex.com. K'NEX UK Ltd, 200 Brook Drive, Green Park, Reading, RG6 2UB England; K'NEX France, 24 rue du Quatre Septembre, 75002 Paris, France. For customers outside the USA/Canada please contact your local distributor at www.knex.com/distributors.

(FR) Pour les clients en dehors du Canada et des États-Unis, veuillez contacter votre distributeur local que vous pouvez trouver sur www.knex.com/distributors.

(ES) El cliente que no vive en EE.UU./Canadá se pone en contacto con el distribuidor local. Encuentre la información para el distribuidor local en www.knex.com/distributors.

(EN) K'NEX is a registered trademark and Imagine and Steamagination are trademarks of K'NEX Limited Partnership Group.

(FR) K'NEX est une marque déposée et Imagine et Steamagination sont une marque de K'NEX Limited Partnership Group.

(ES) K'NEX es una marca registrada y Imagine y Steamagination son marcas de K'NEX Limited Partnership Group.

(EN) Product & colors may vary. Most models can be built one at a time.

(FR) Le produit et ses couleurs peuvent varier. Les différents modèles ne peuvent être construits qu'un par un.

(ES) El producto y los colores pueden variar. La mayoría de los modelos se pueden construir uno a la vez.

(DE) Produkte und Farben können abweichen. Die meisten Modelle können immer nur einzeln gebaut werden.

(IT) Prodotti e colori possono differire. La maggior parte dei modelli si può costruire autonomamente. Istruzioni accluse.

(PT) O produto e as cores podem variar. A maioria dos modelos pode ser montado um de cada vez.

(NL) Product en kleuren kunnen variëren. De meeste modellen kunnen uitsluitend een voor een worden gebouwd.

