

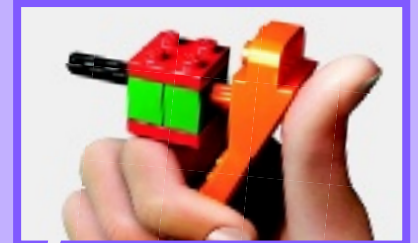

41055

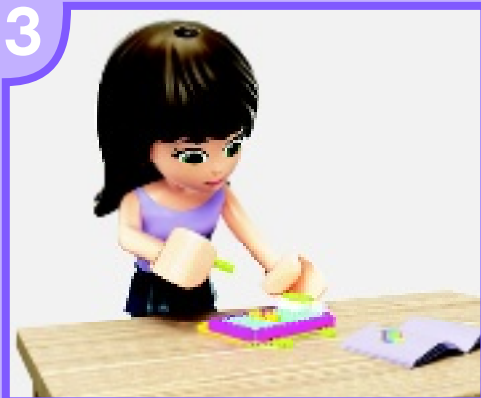

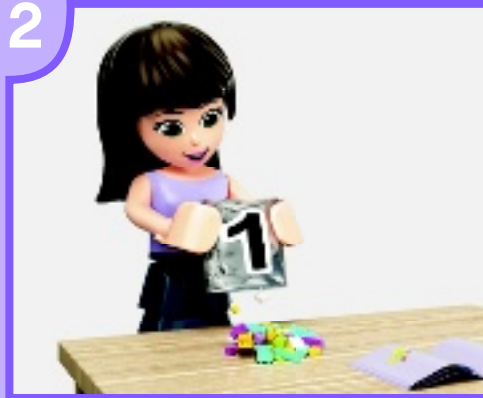
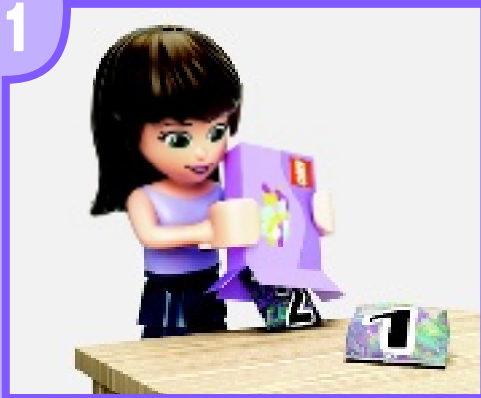

LEGO.com/brickseparator

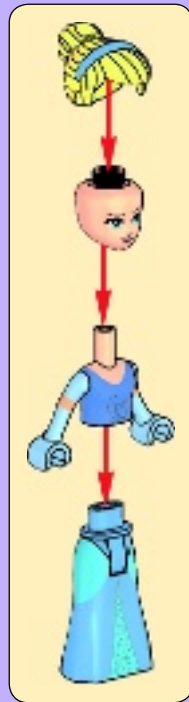
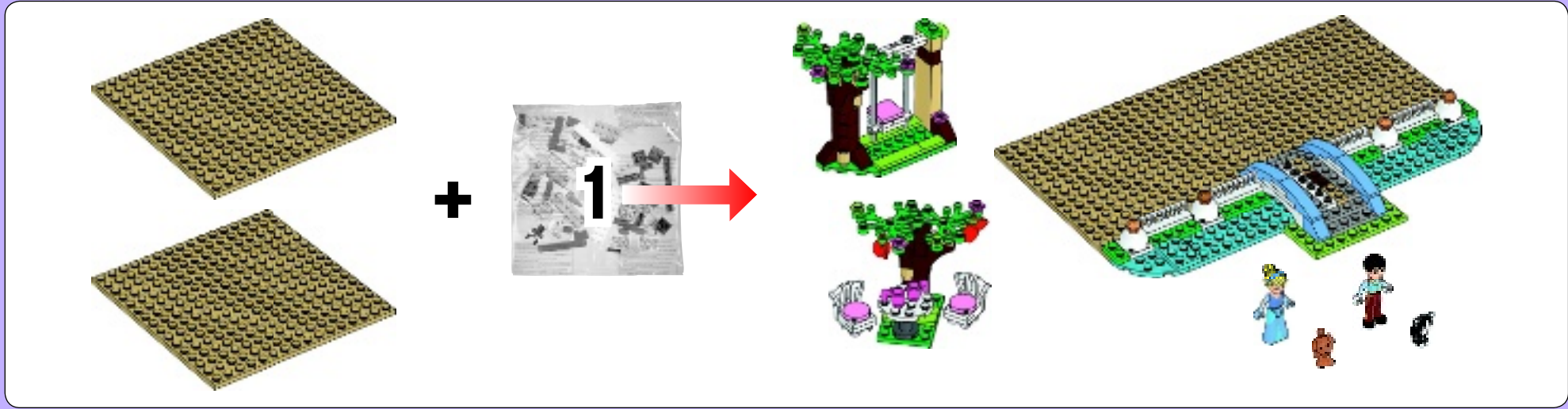

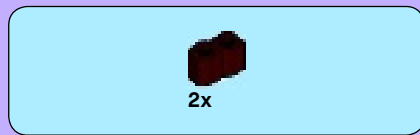
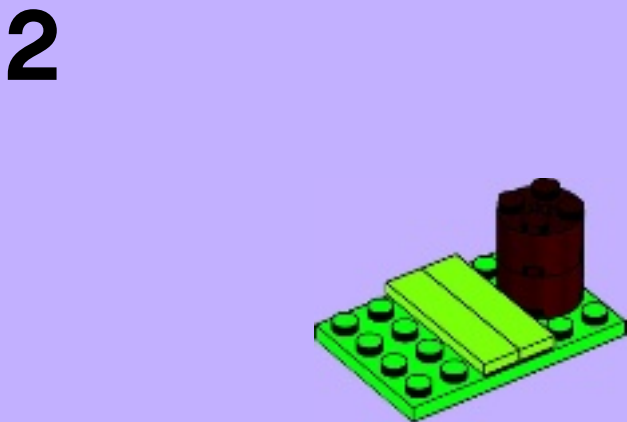
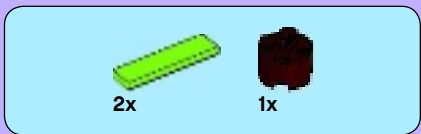
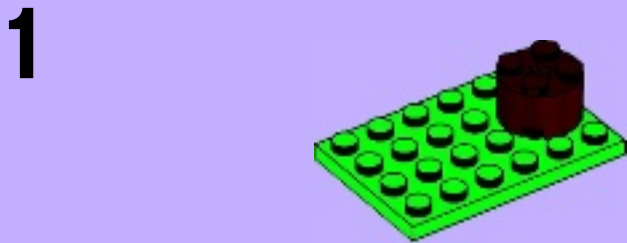
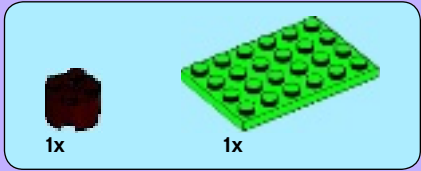

3

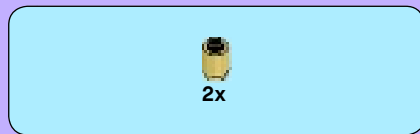
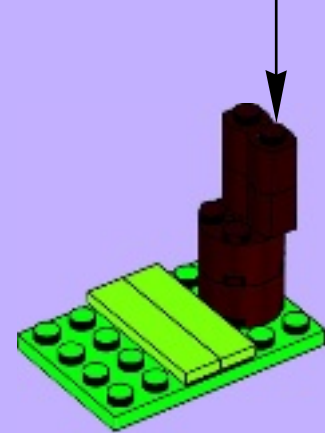

4

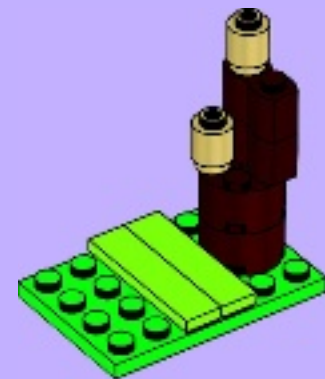



9

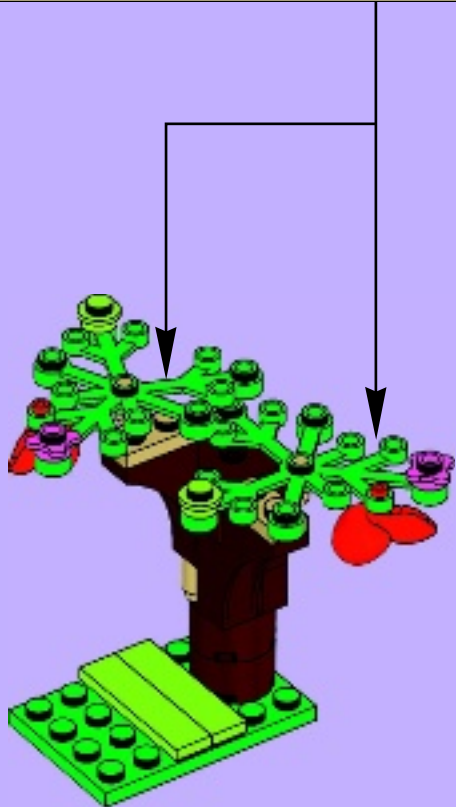
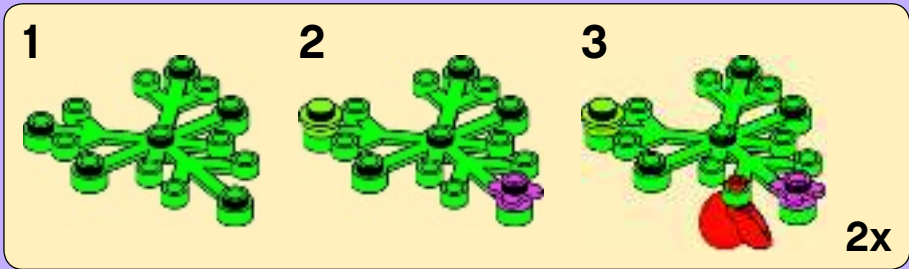

10



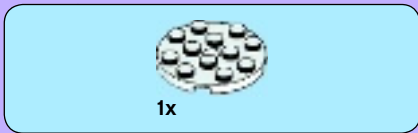

11

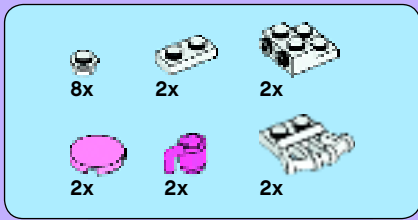

12





1



2

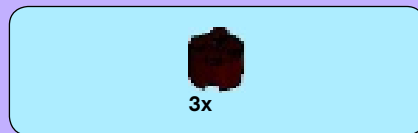

3

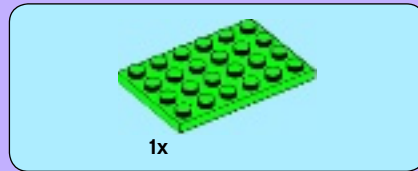
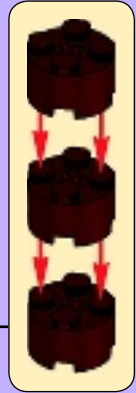

4

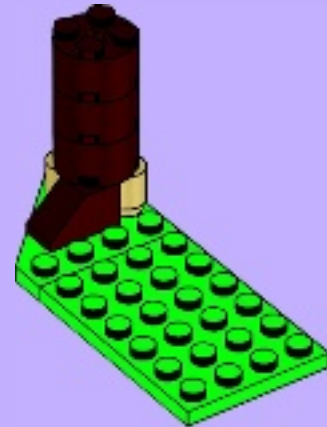

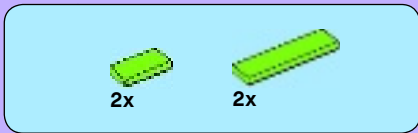

5

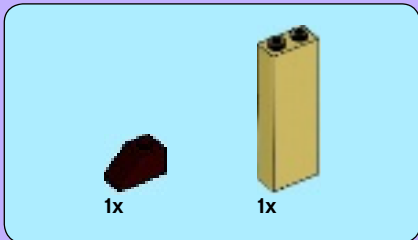
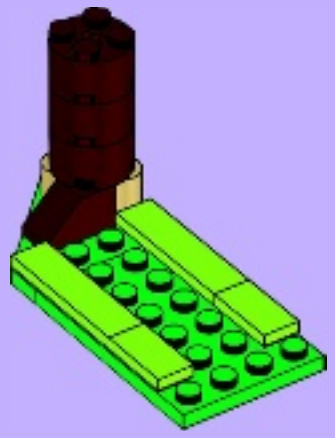

6

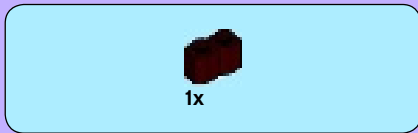
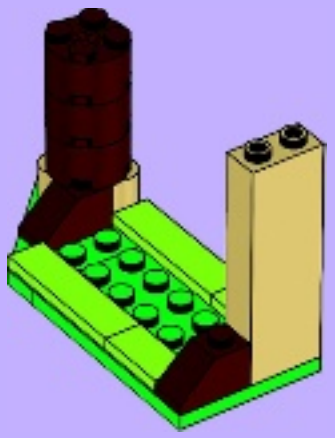

7

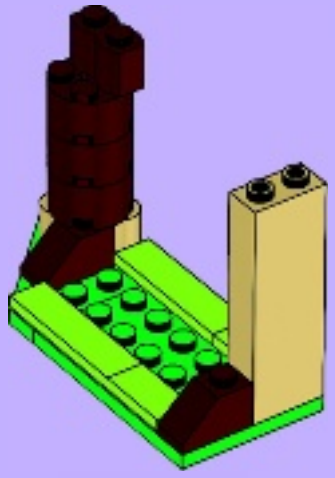

8

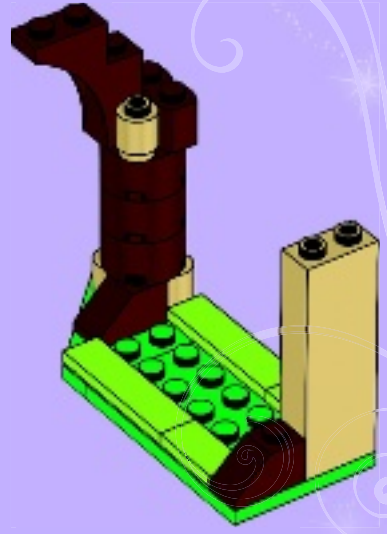



9

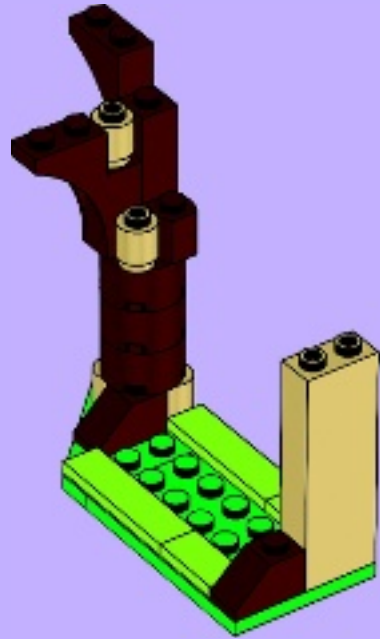

10

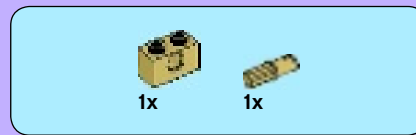
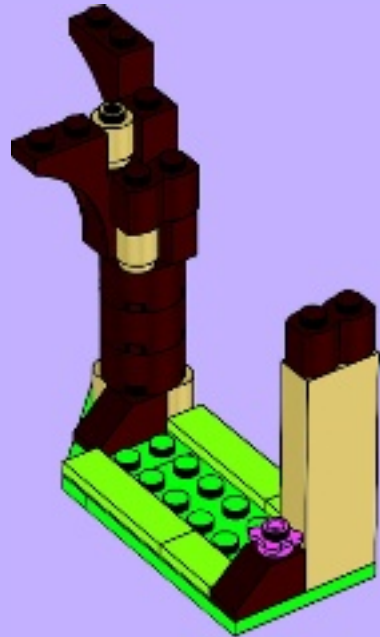

1

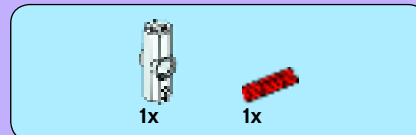
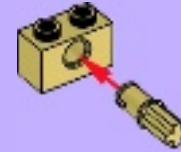

2

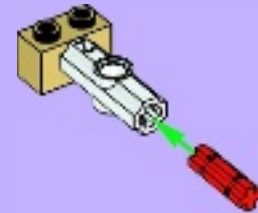

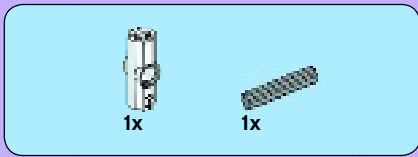

3

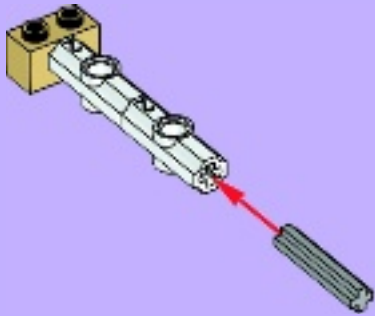

4

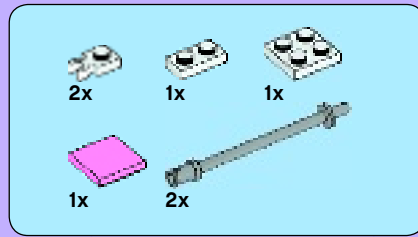
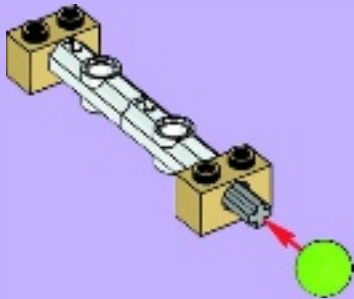

5

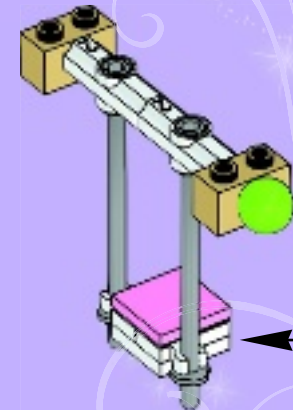
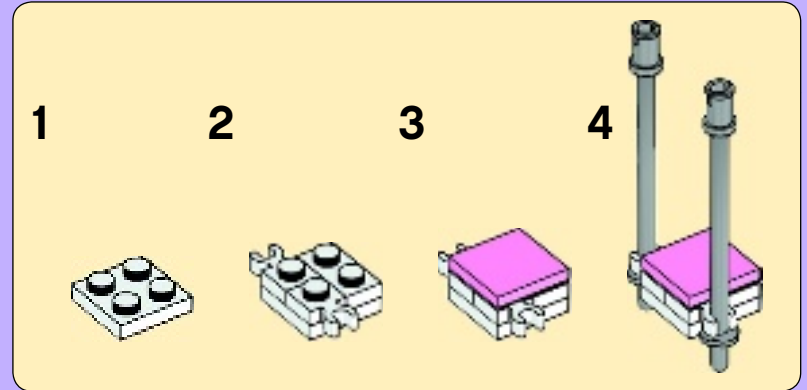



2x

13

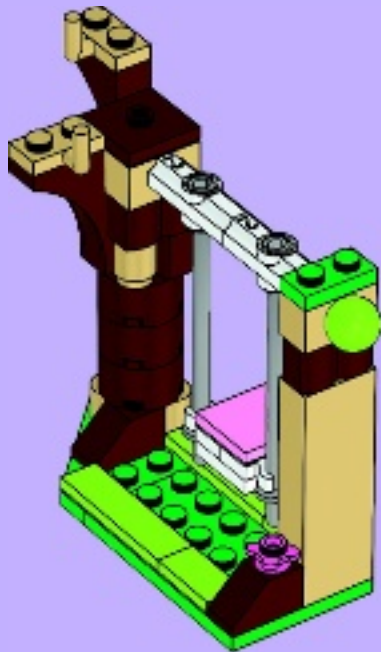

14

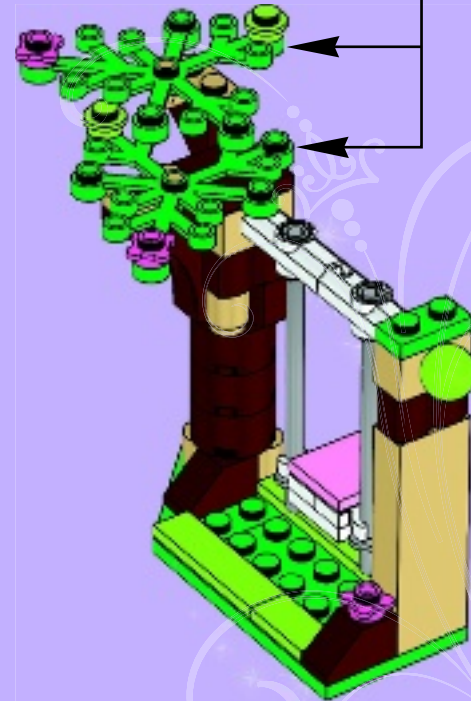
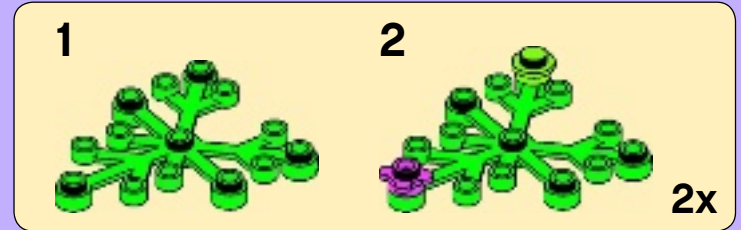

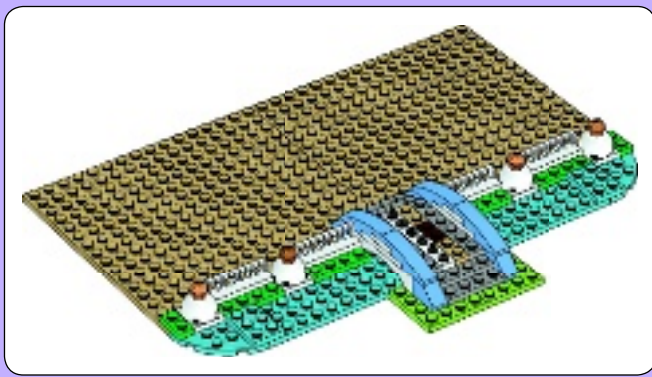

1

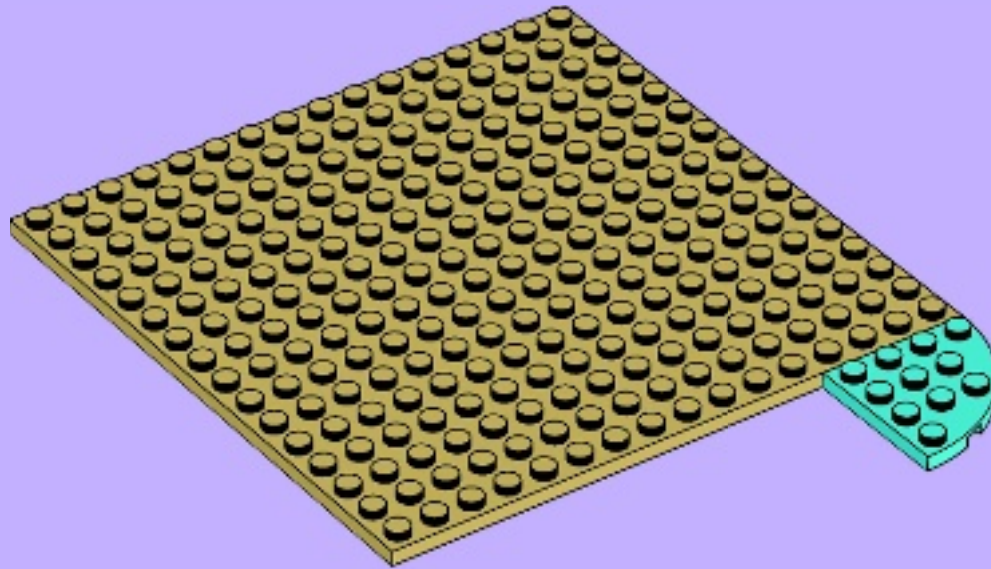



2

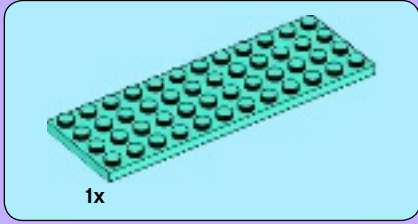
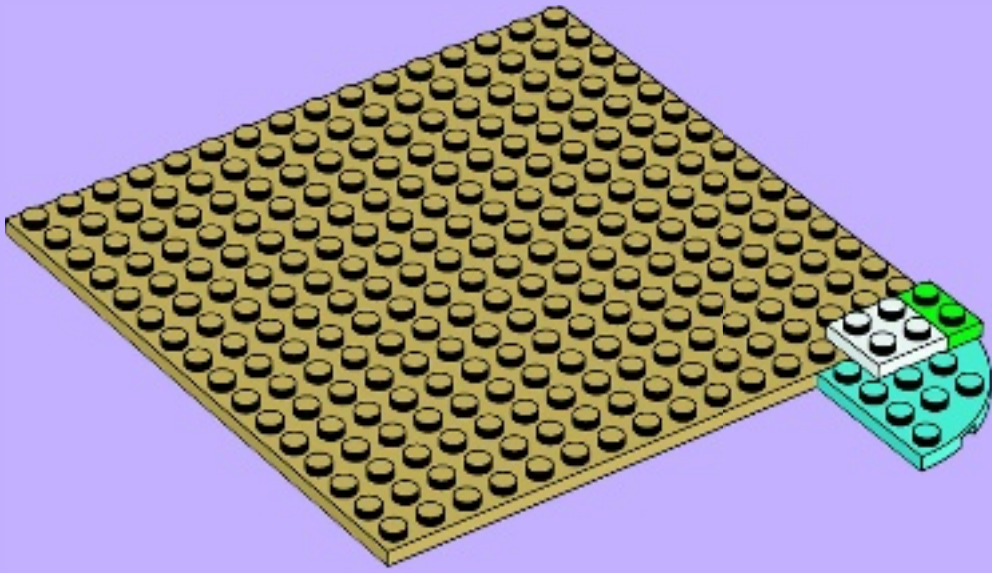

3

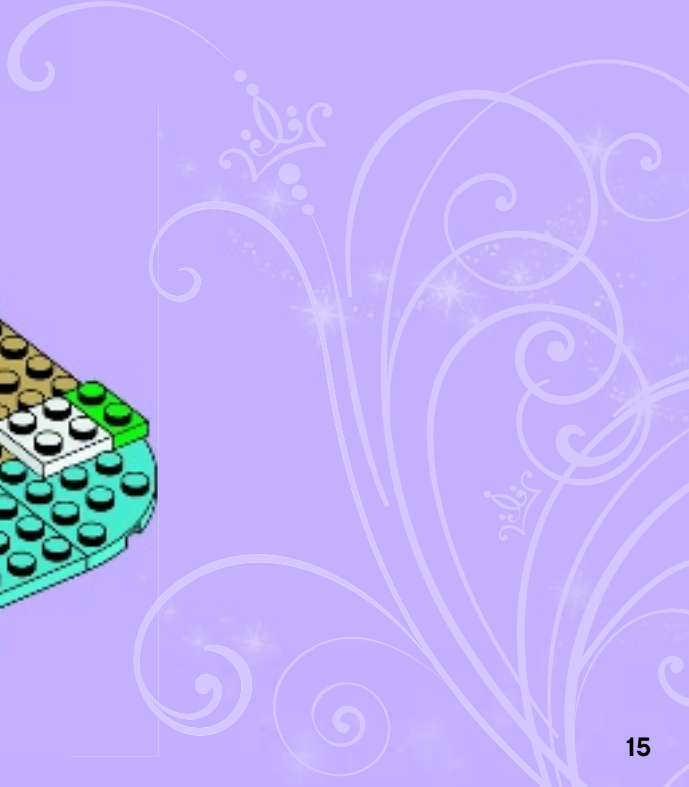
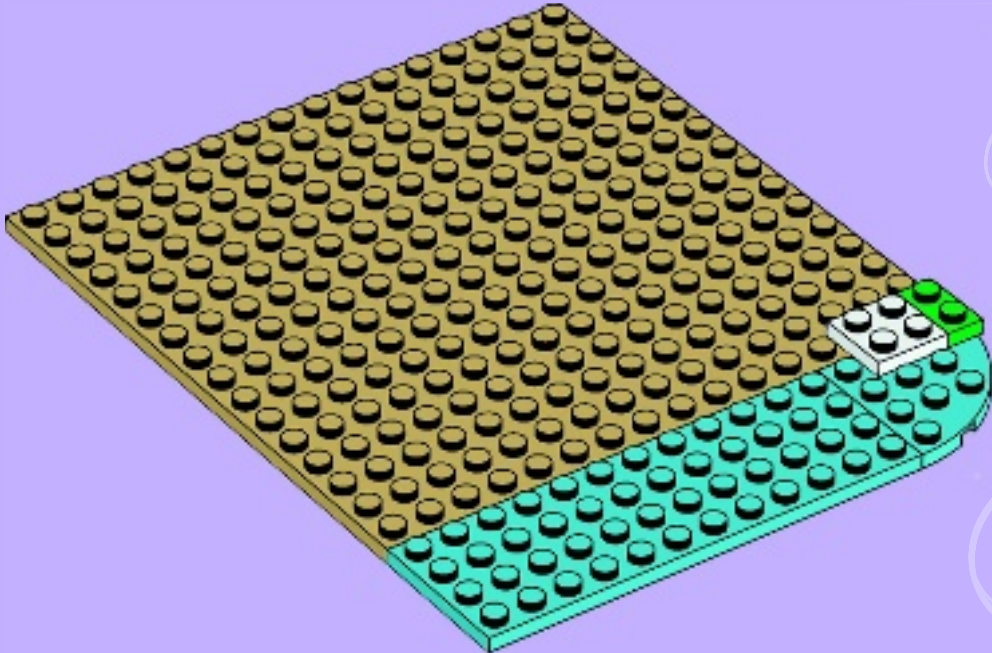



2x



1x

4

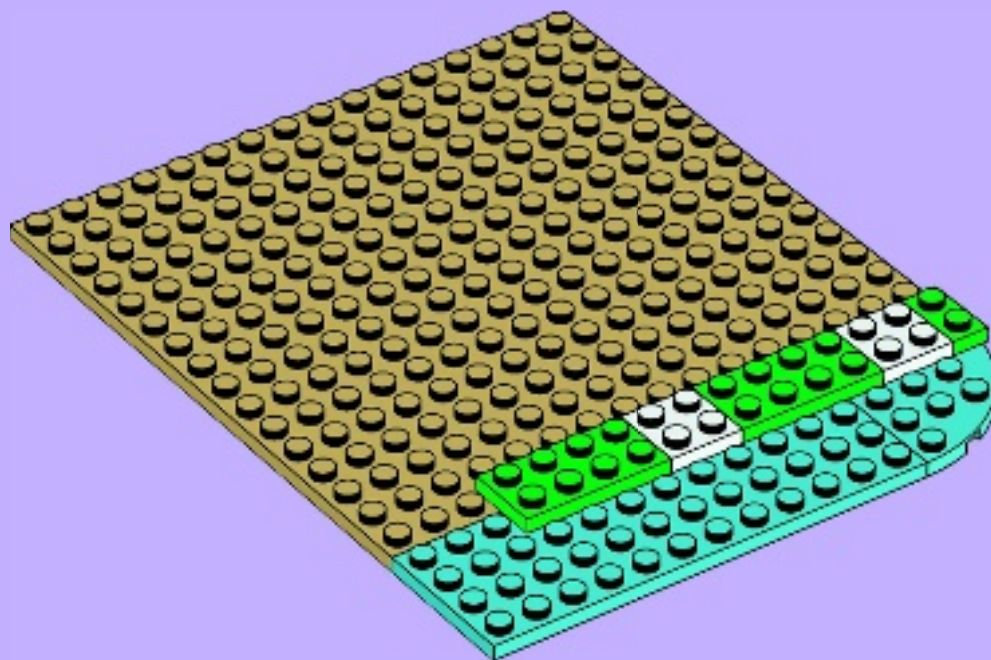

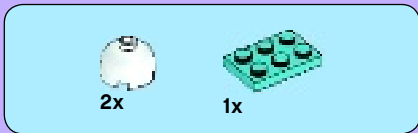

5

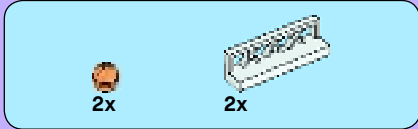
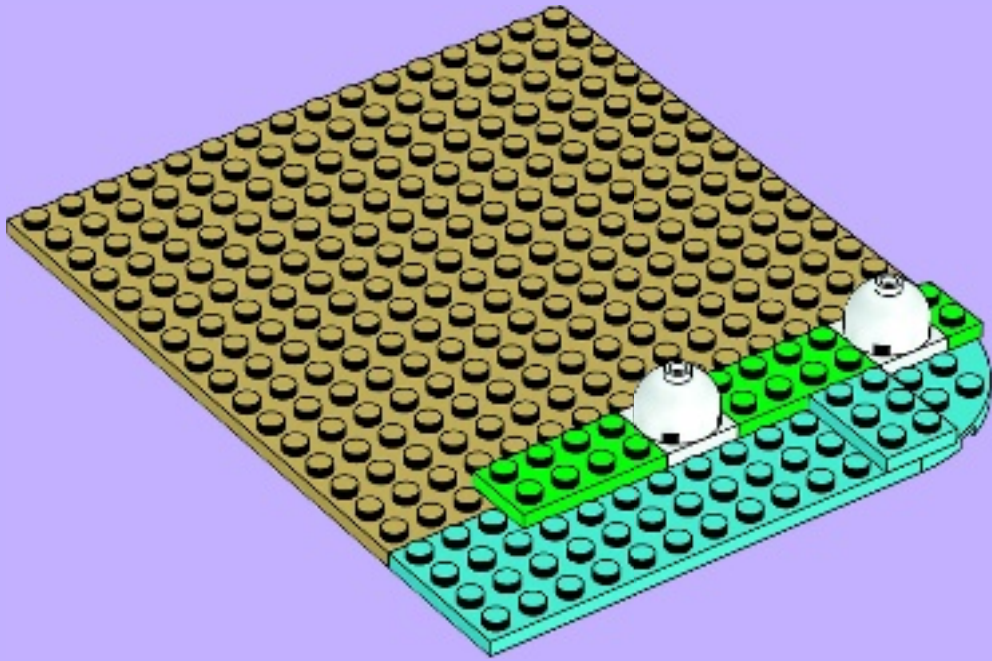

6

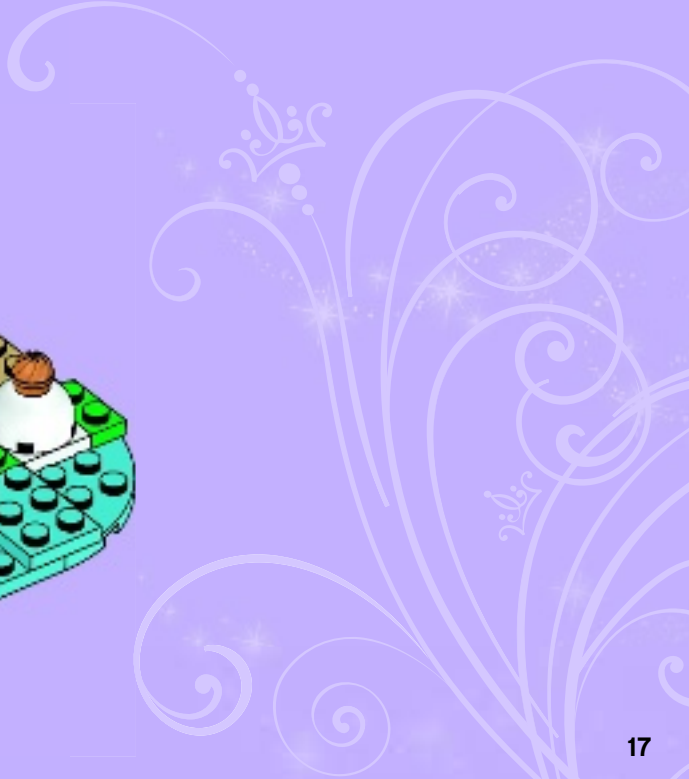
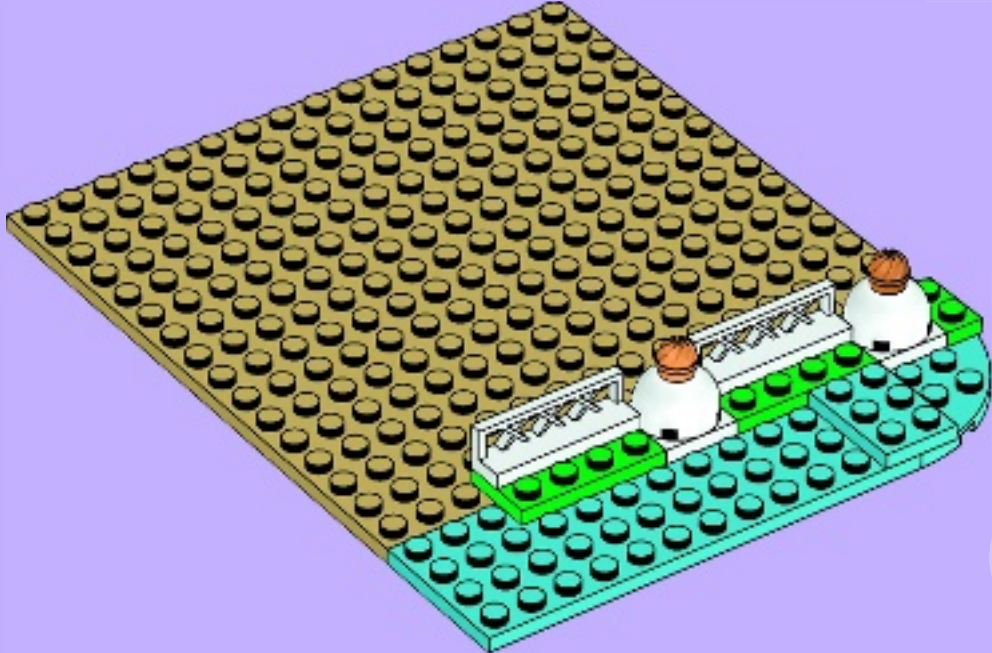



7

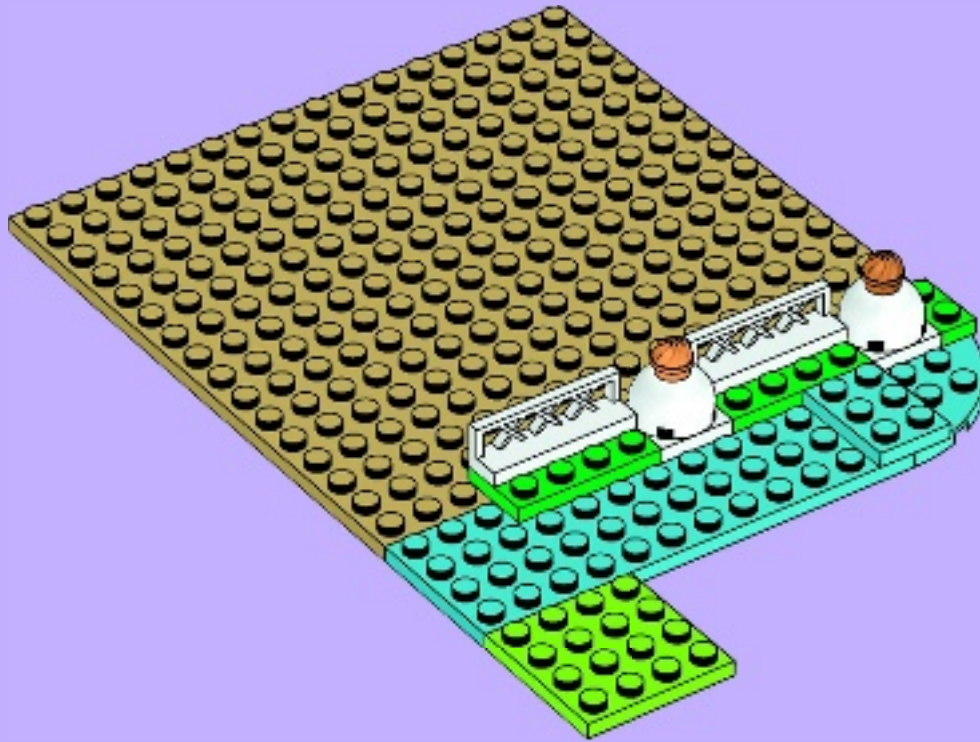

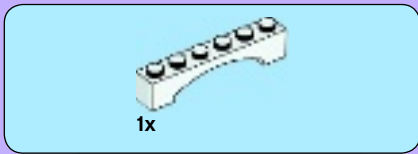

8

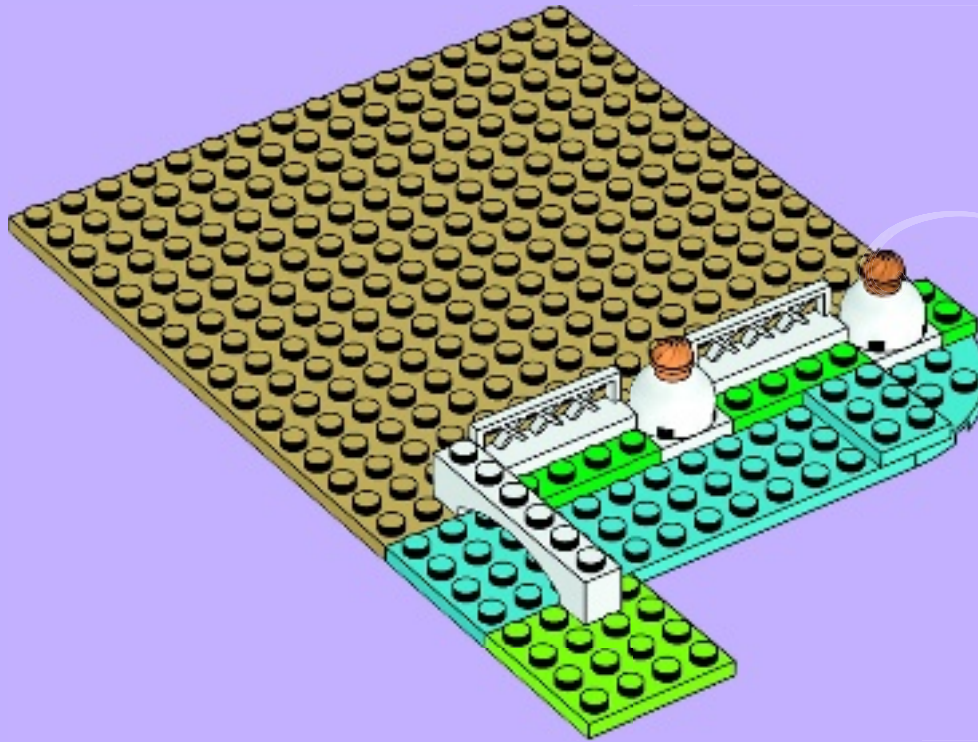

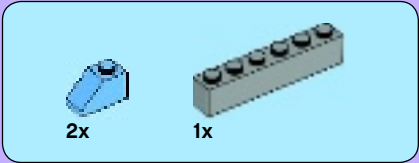

9

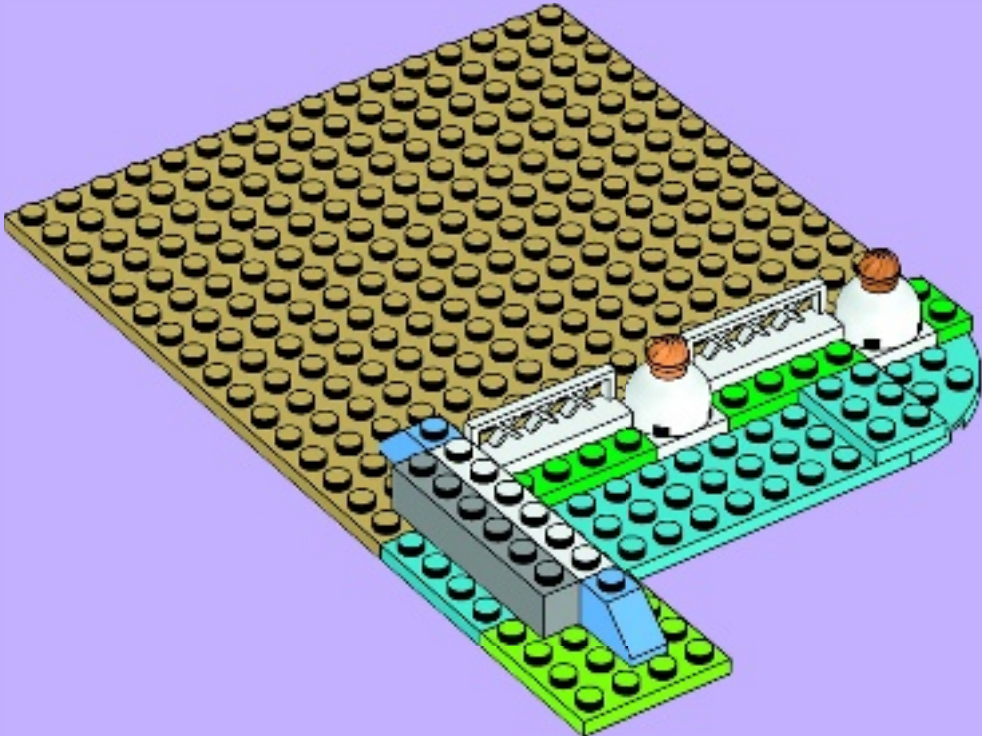

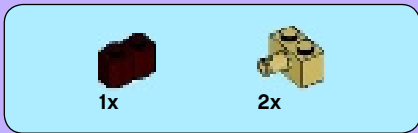

10

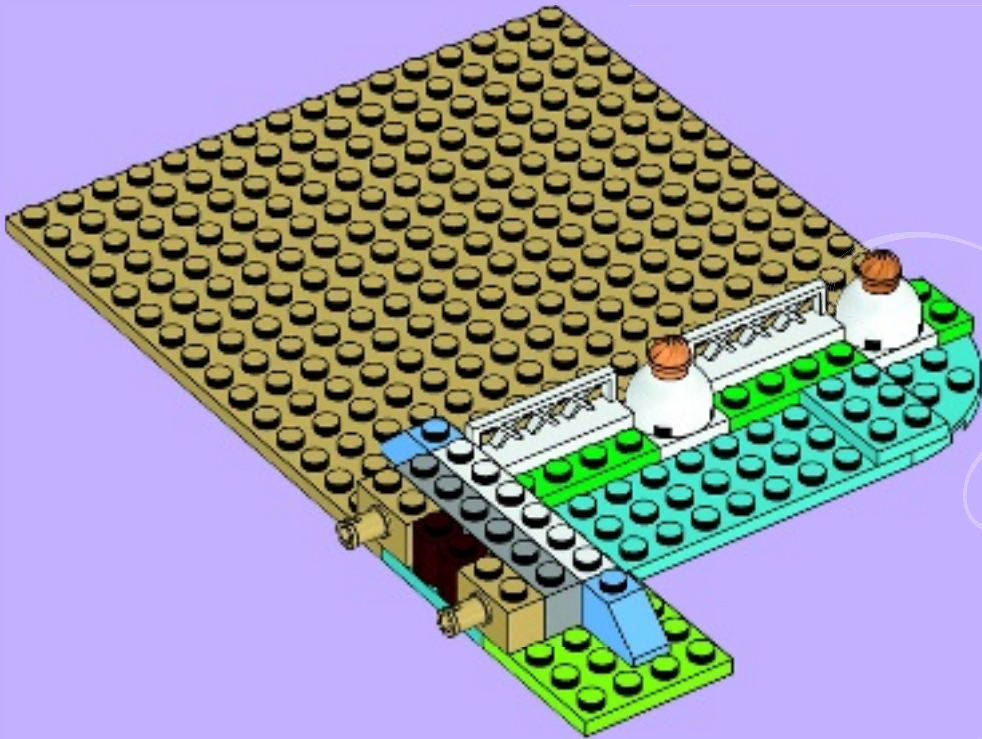



11

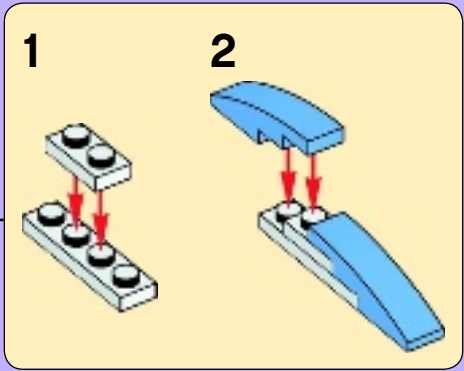
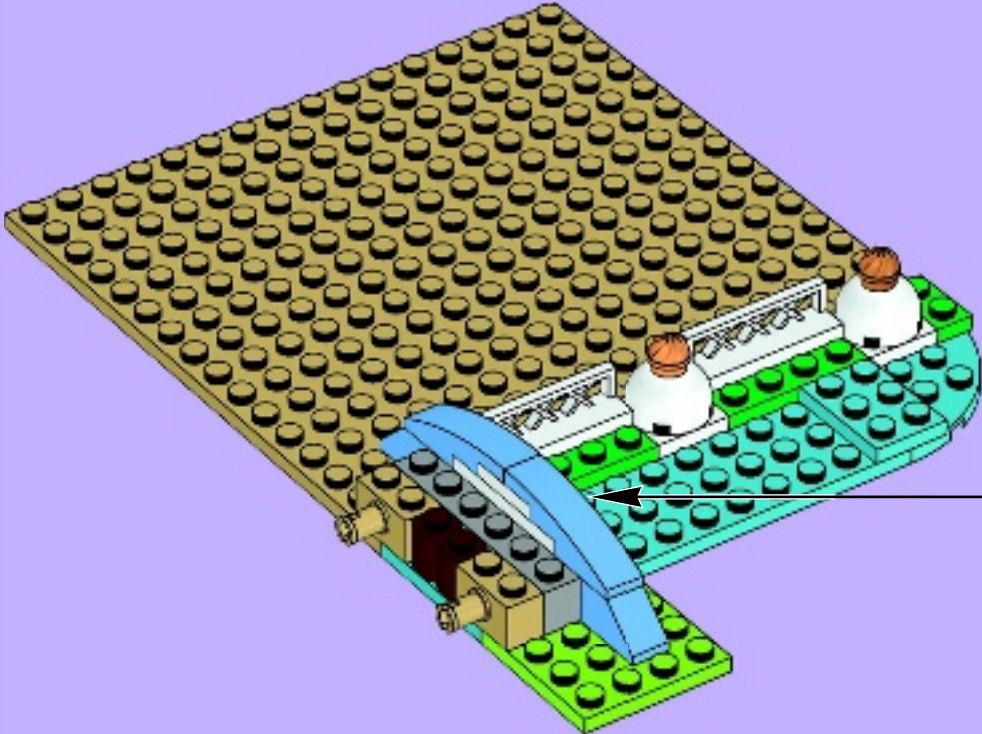

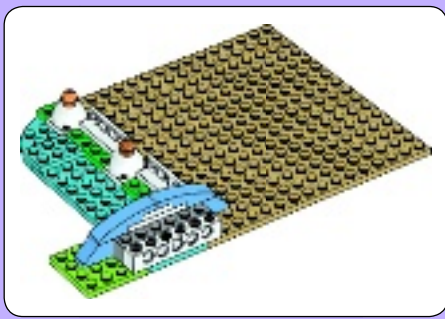

1

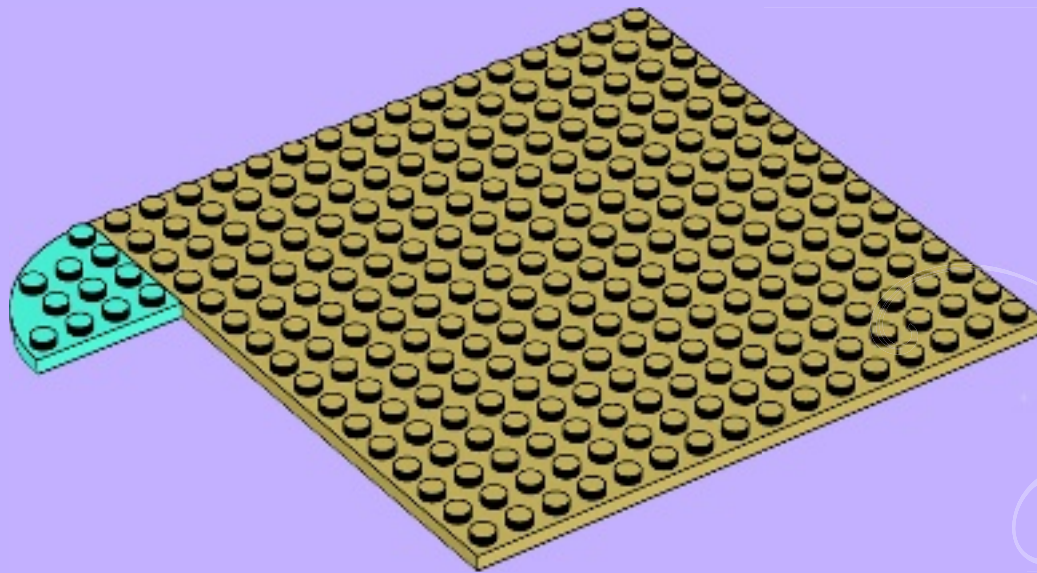

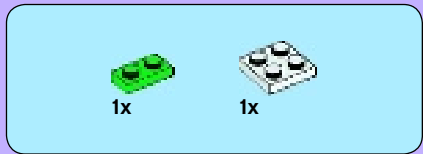

2

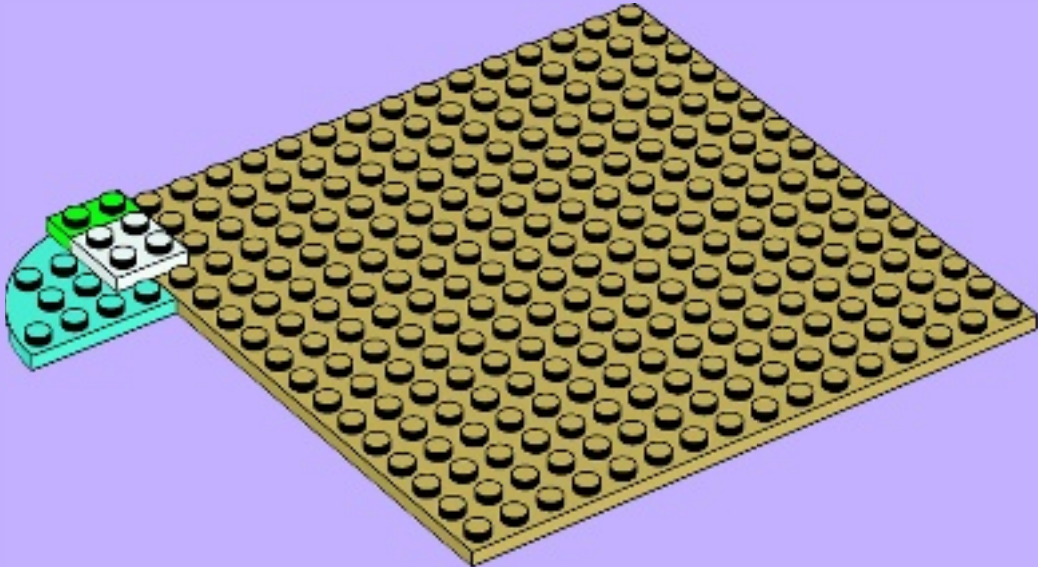

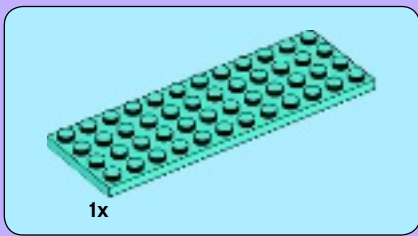

3

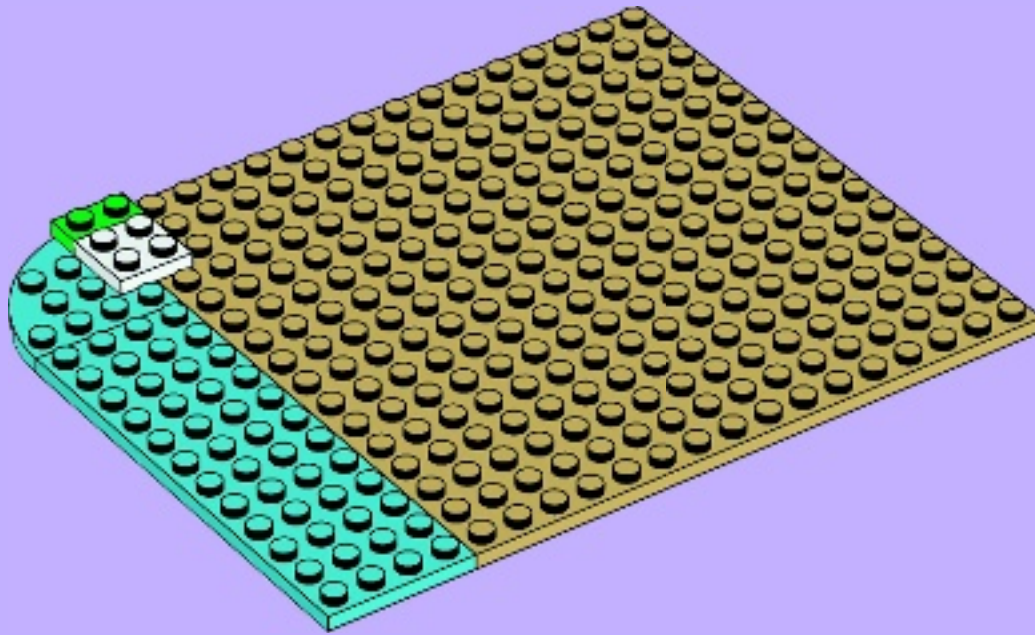

4

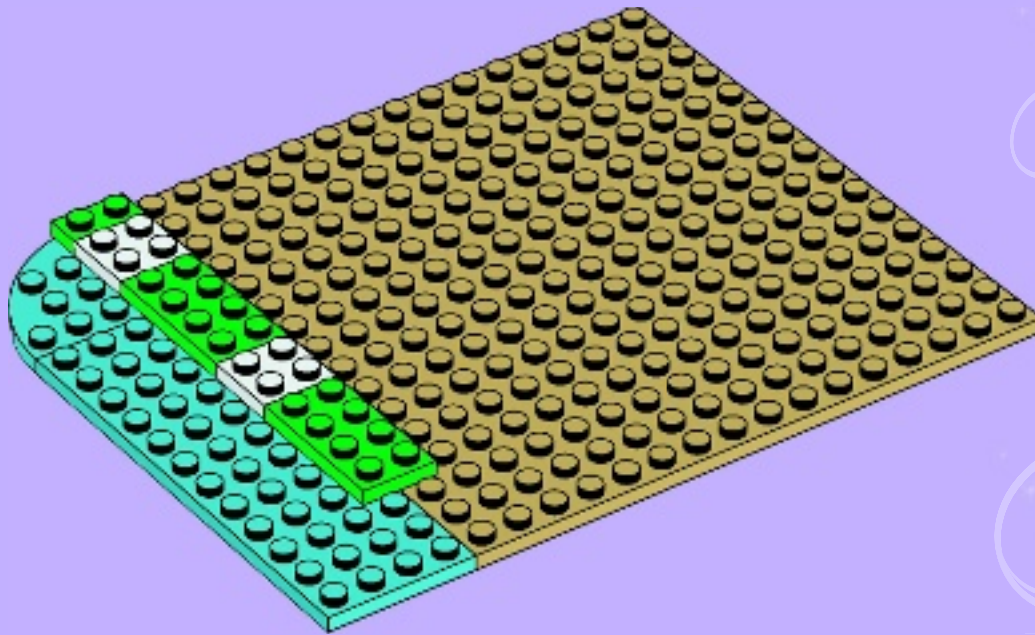

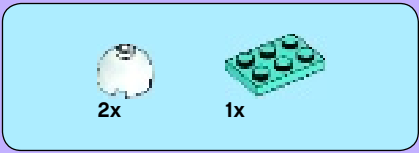

5

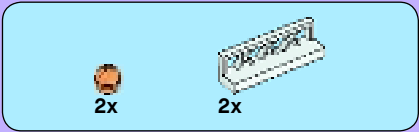
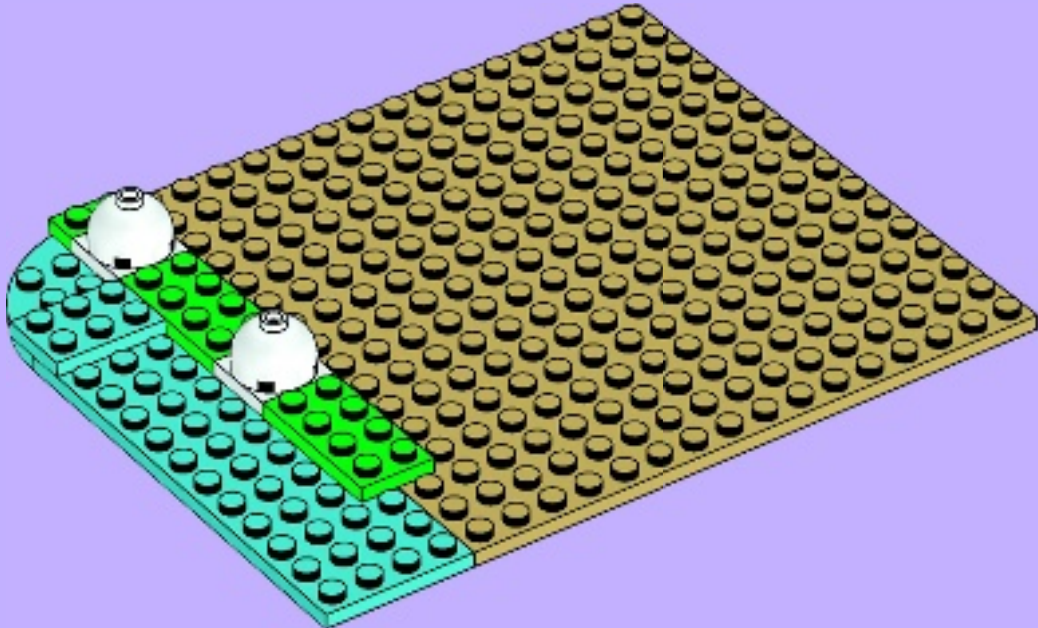

6

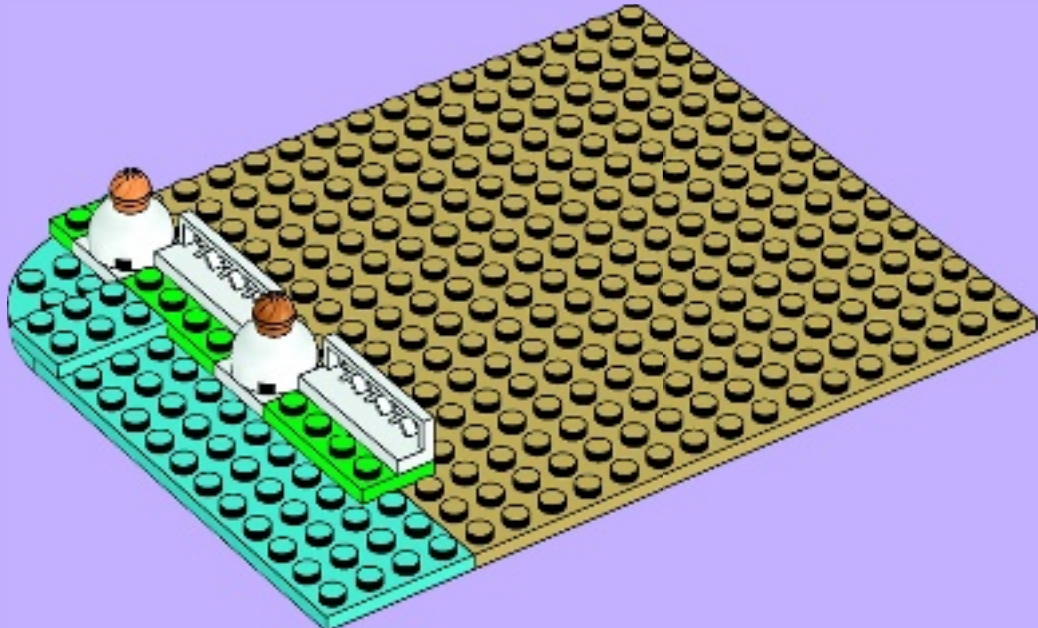

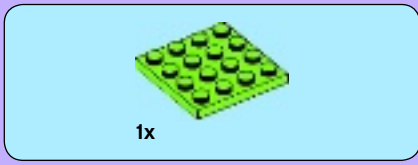

7

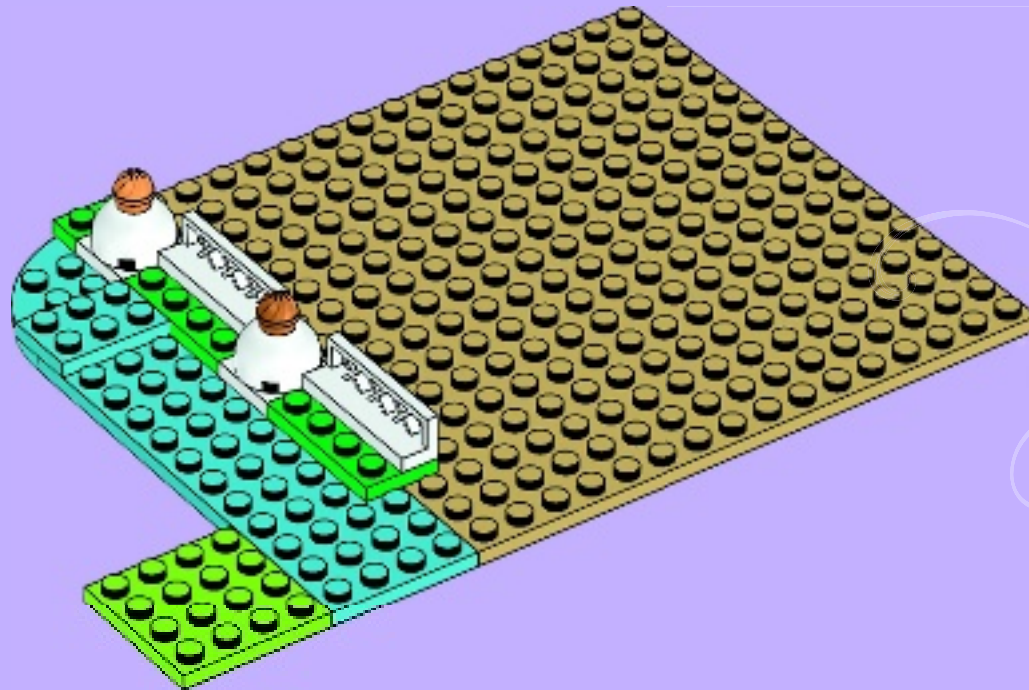

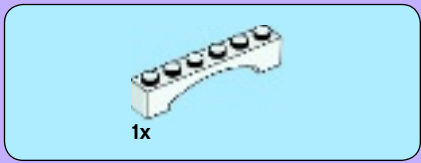

8

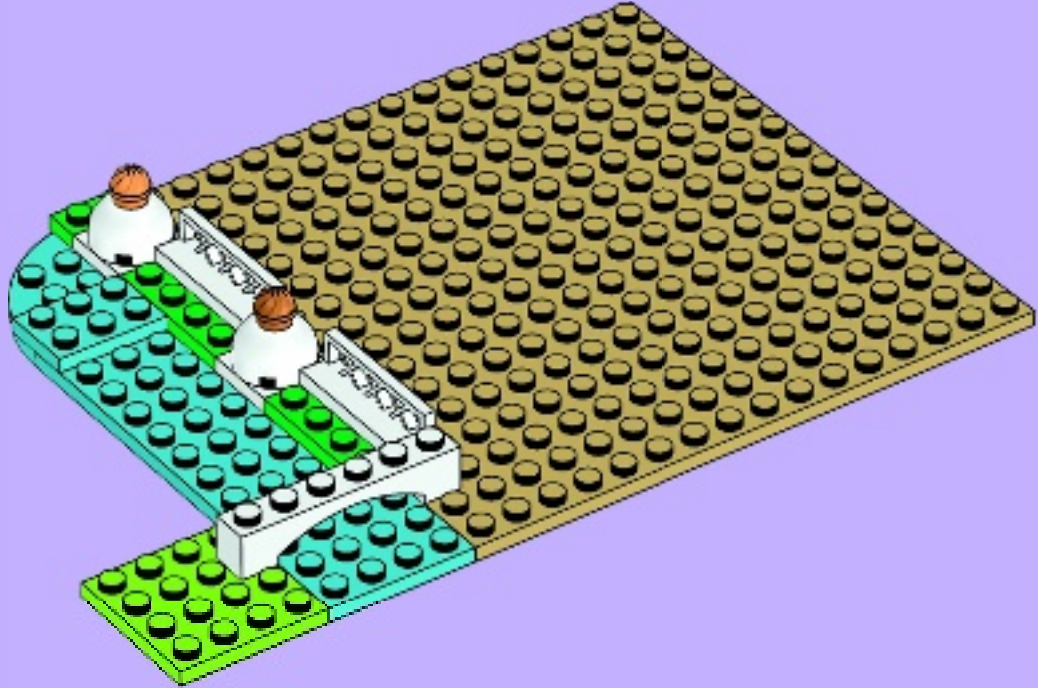

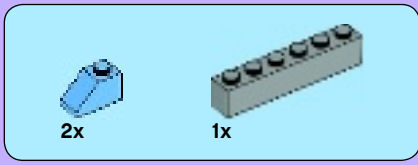

9

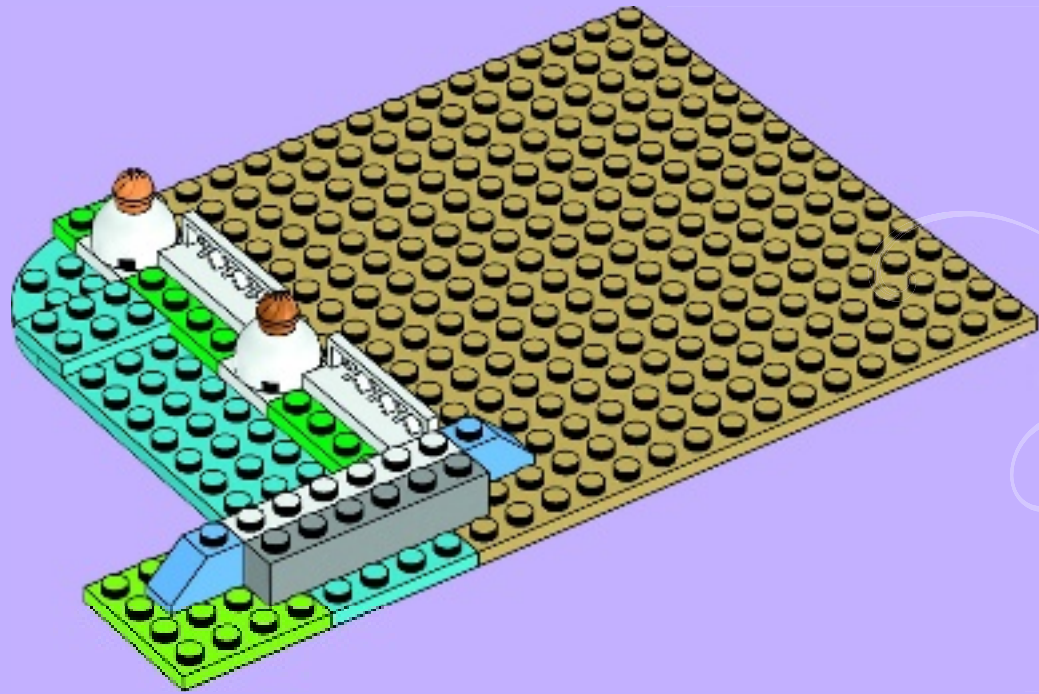

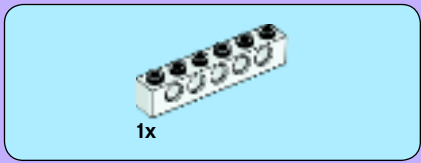

10

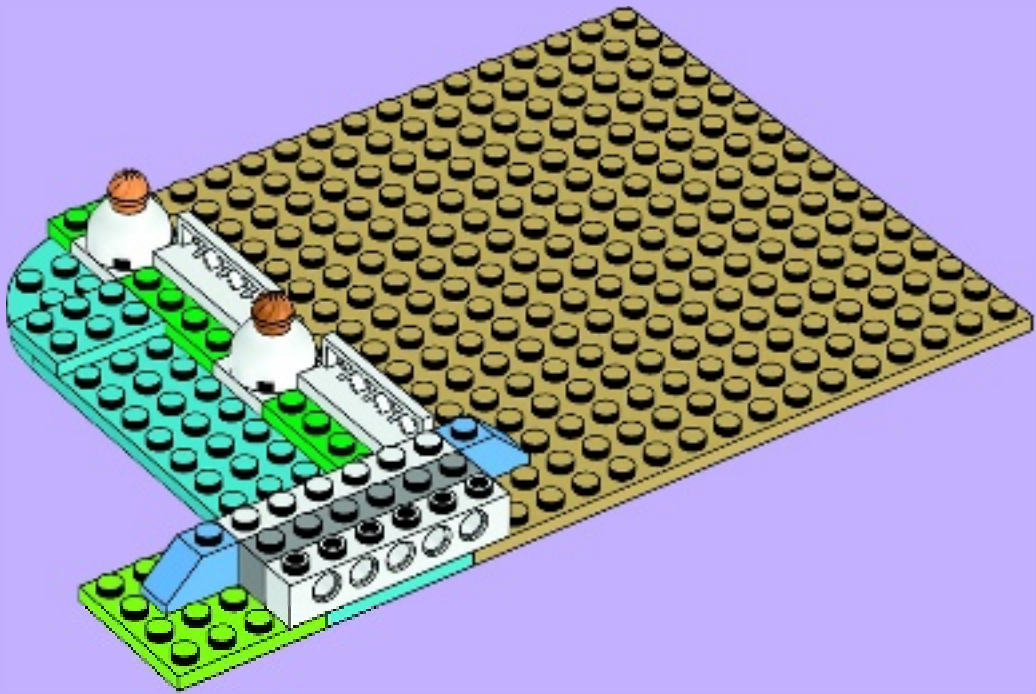

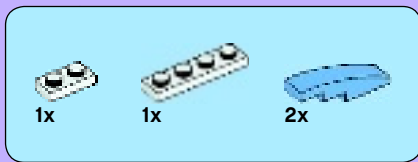

11

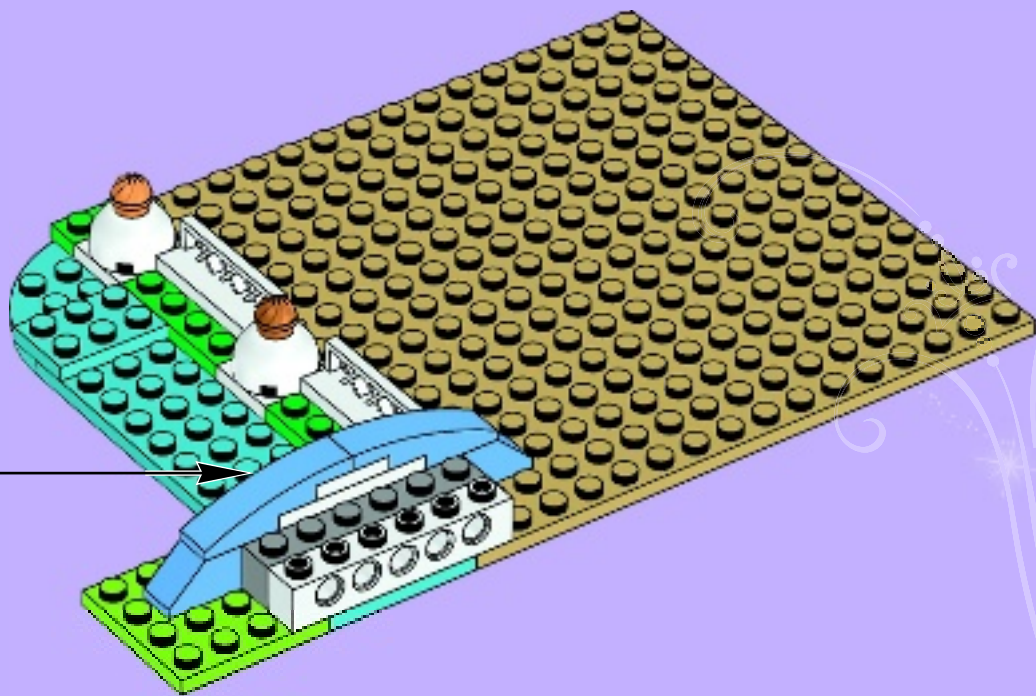
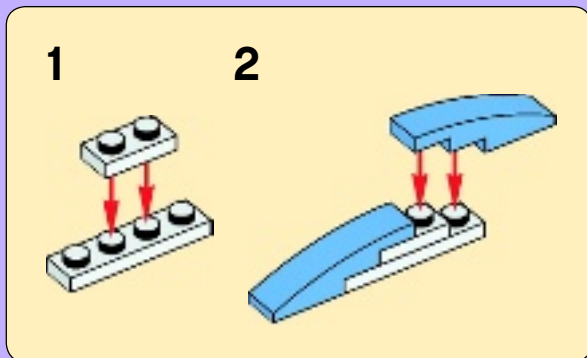

12

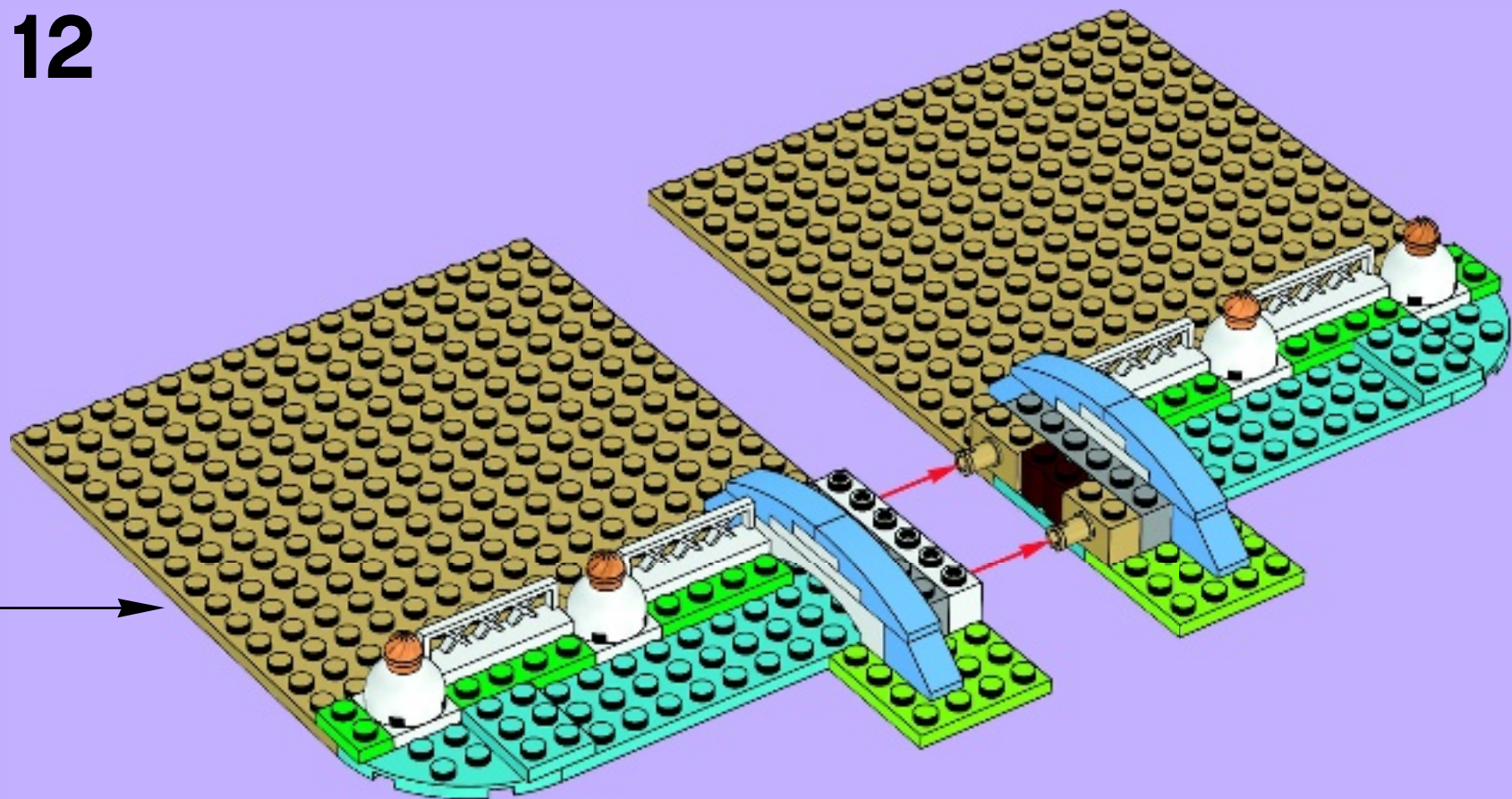

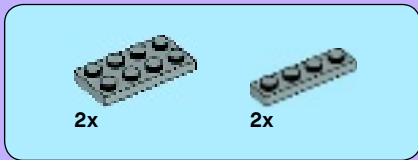

13

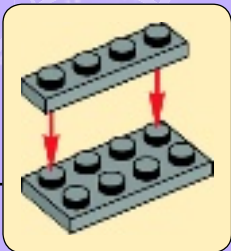
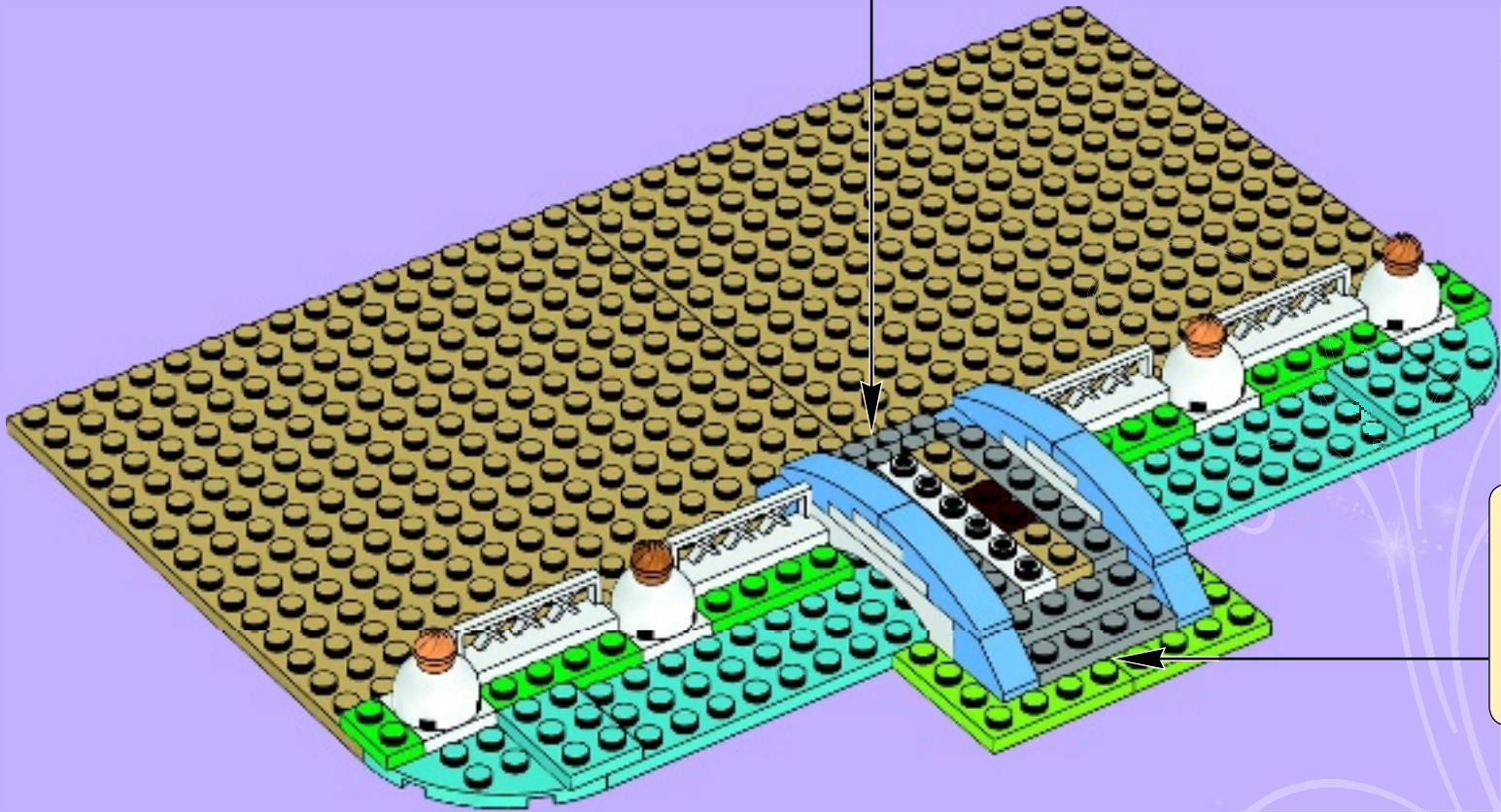
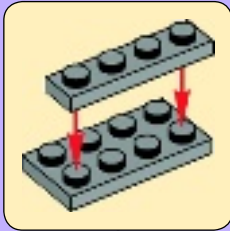



2

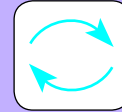
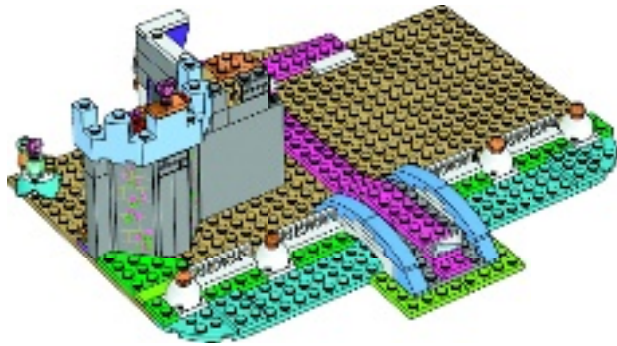

14

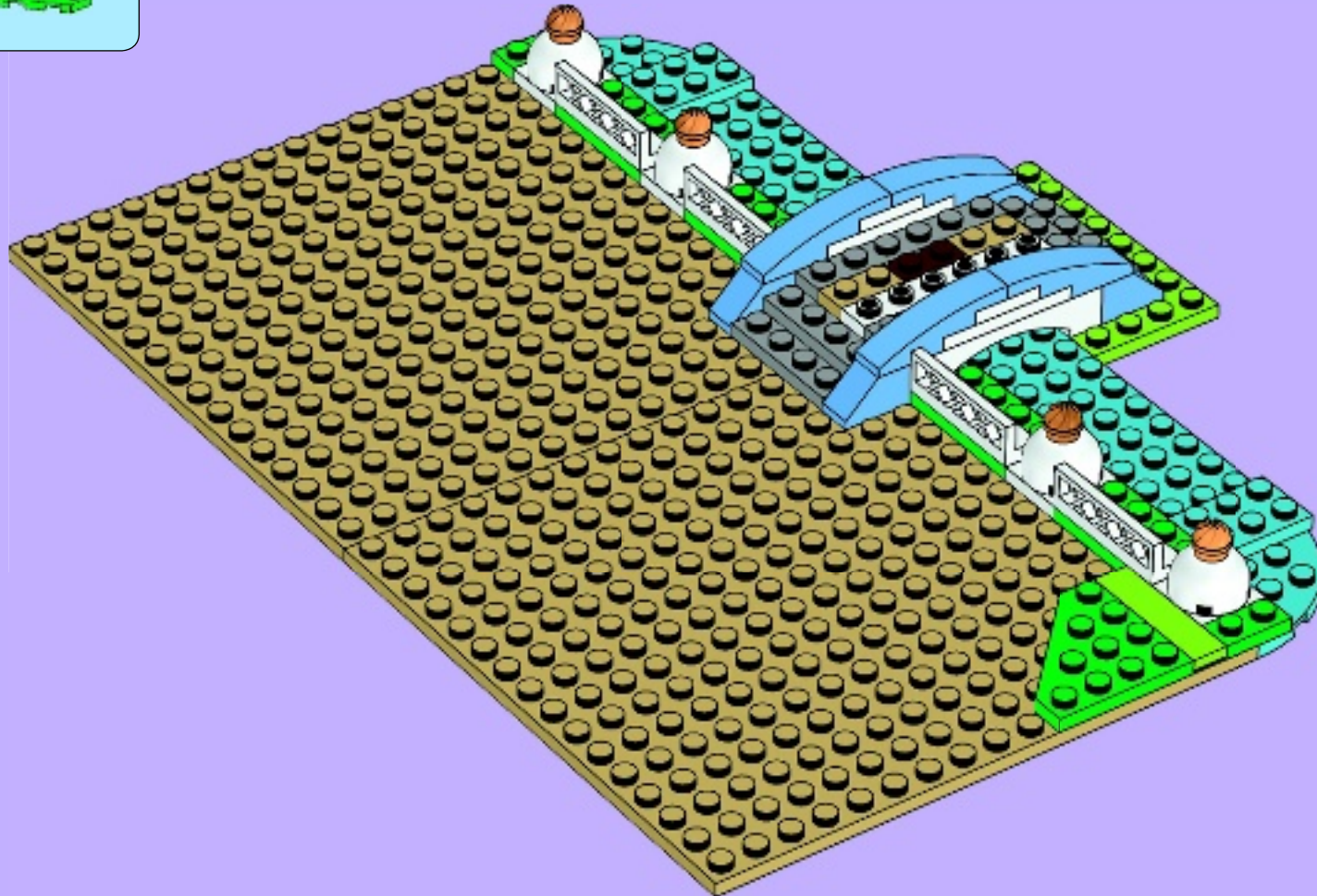

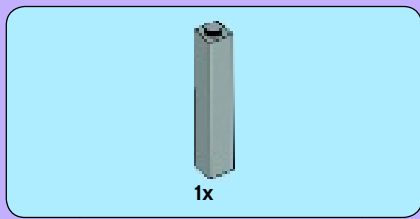

15

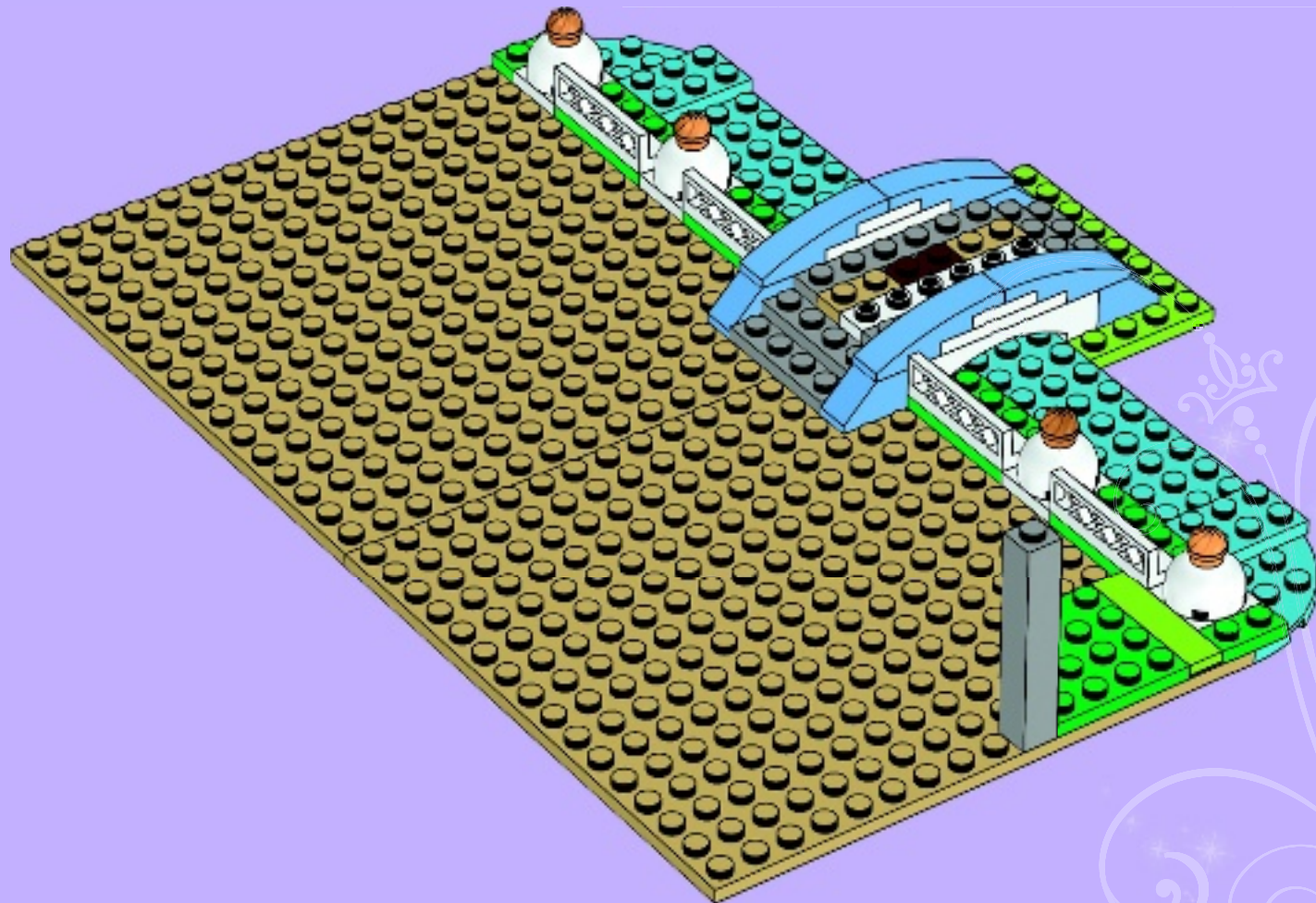

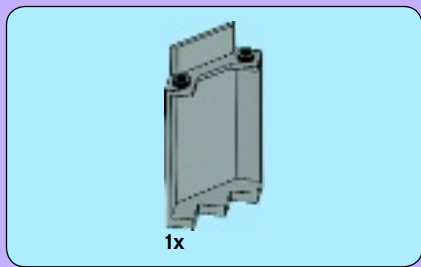

16

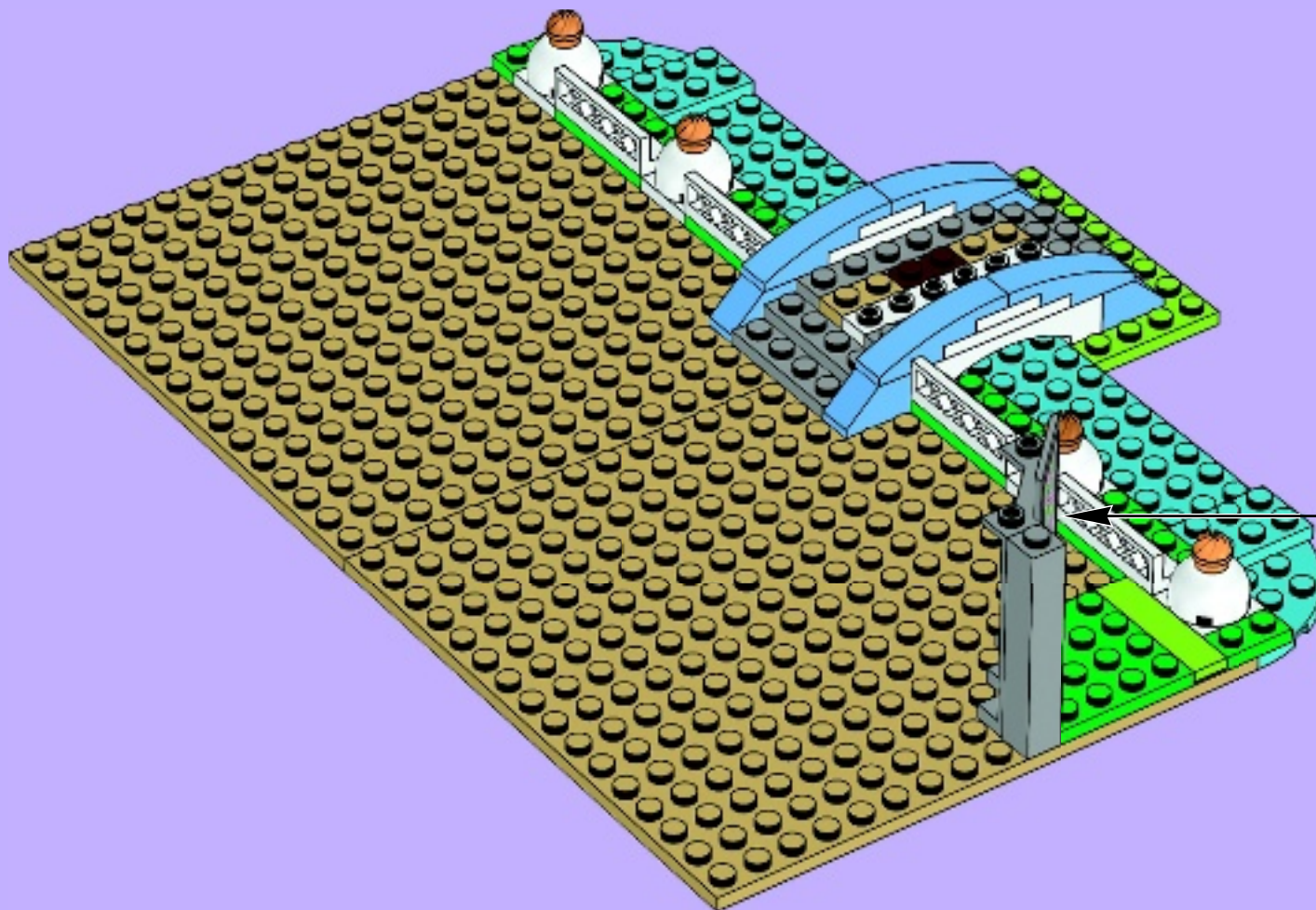
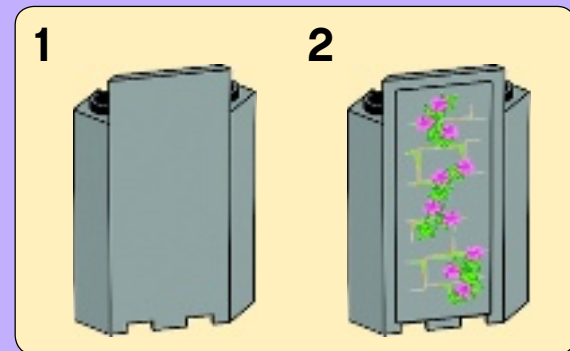

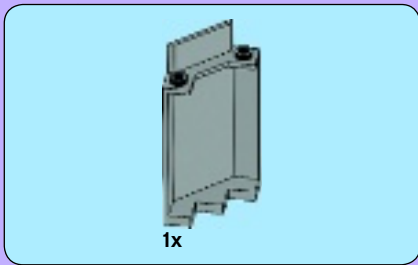

17

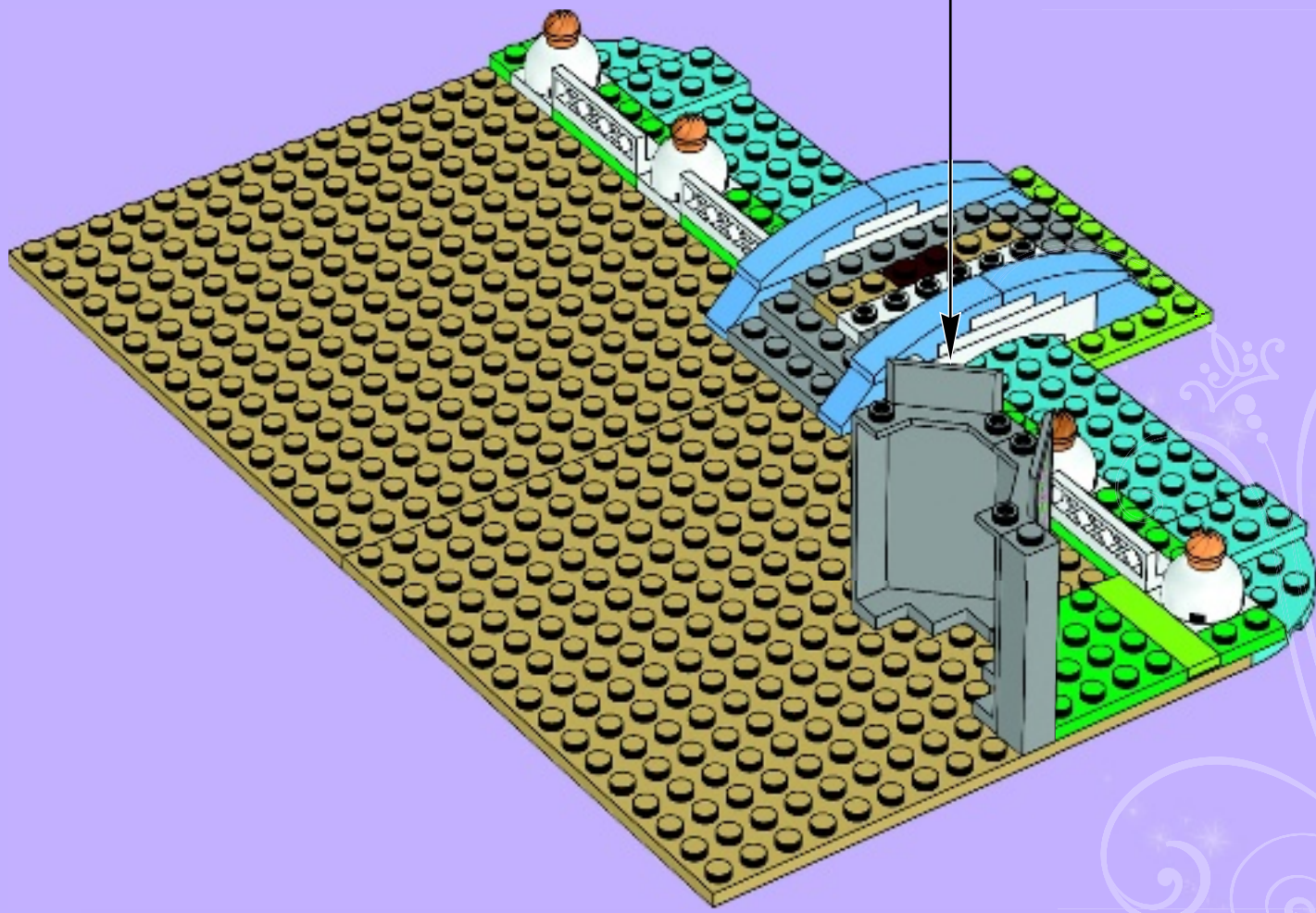
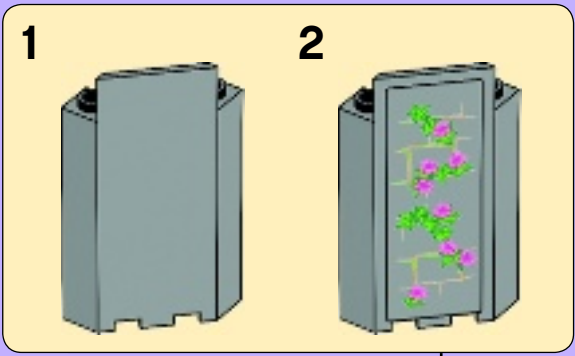

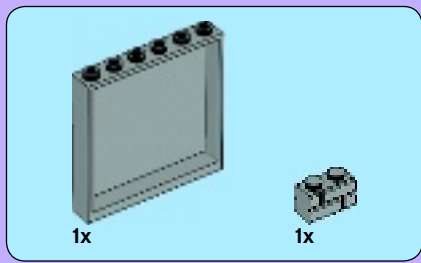

18

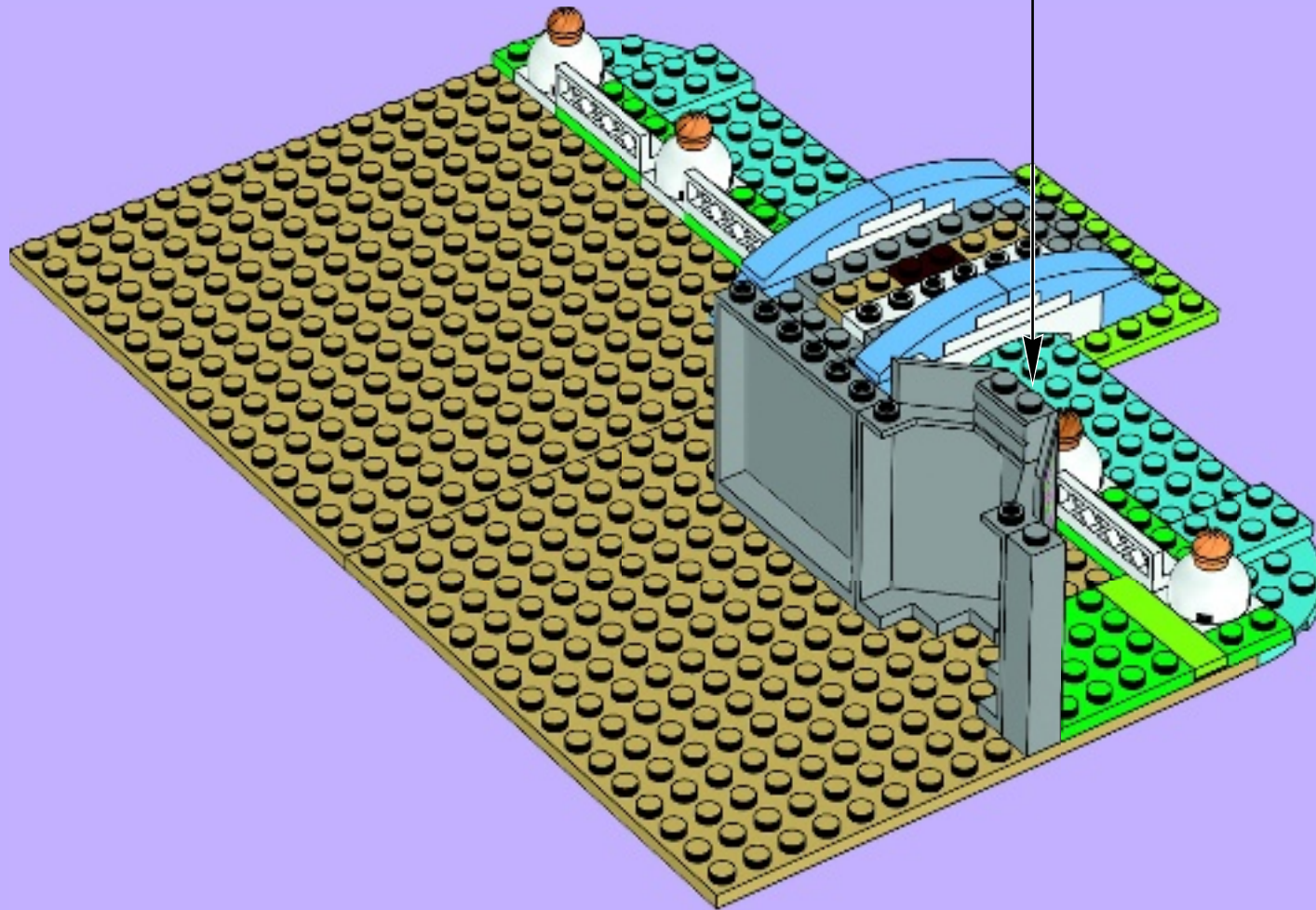



19

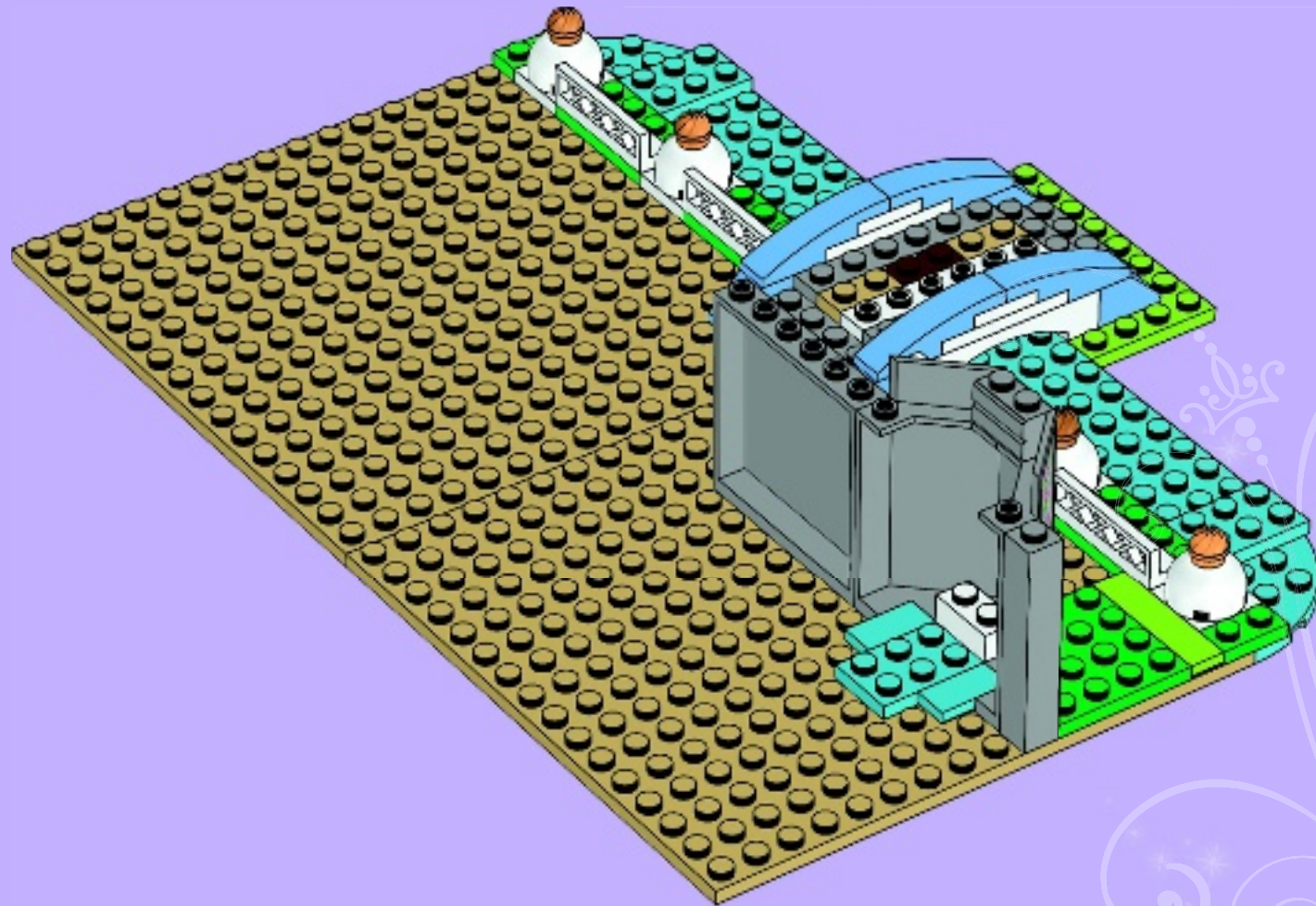

1x



20

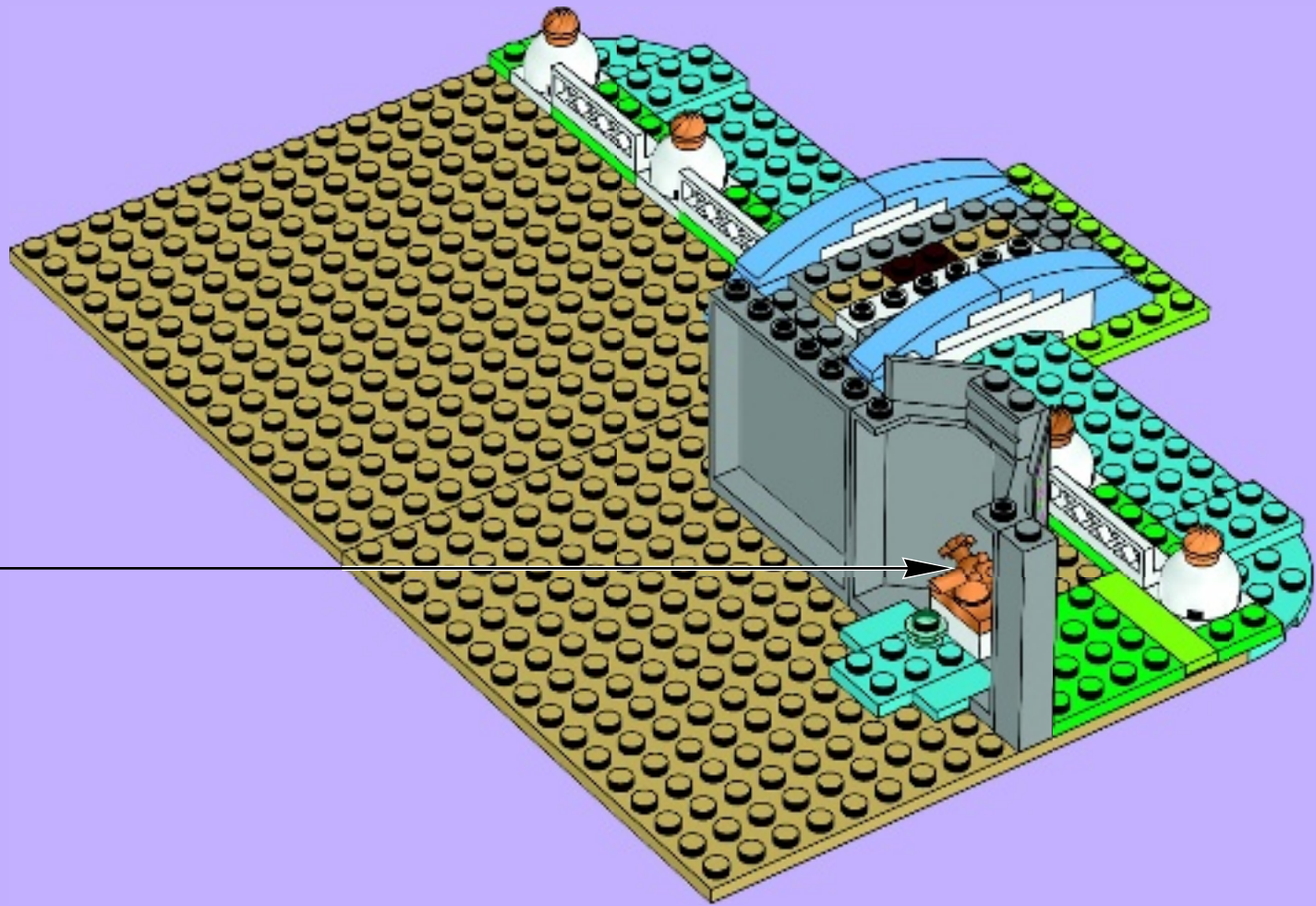

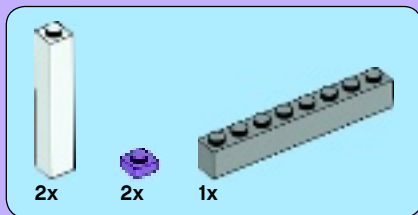

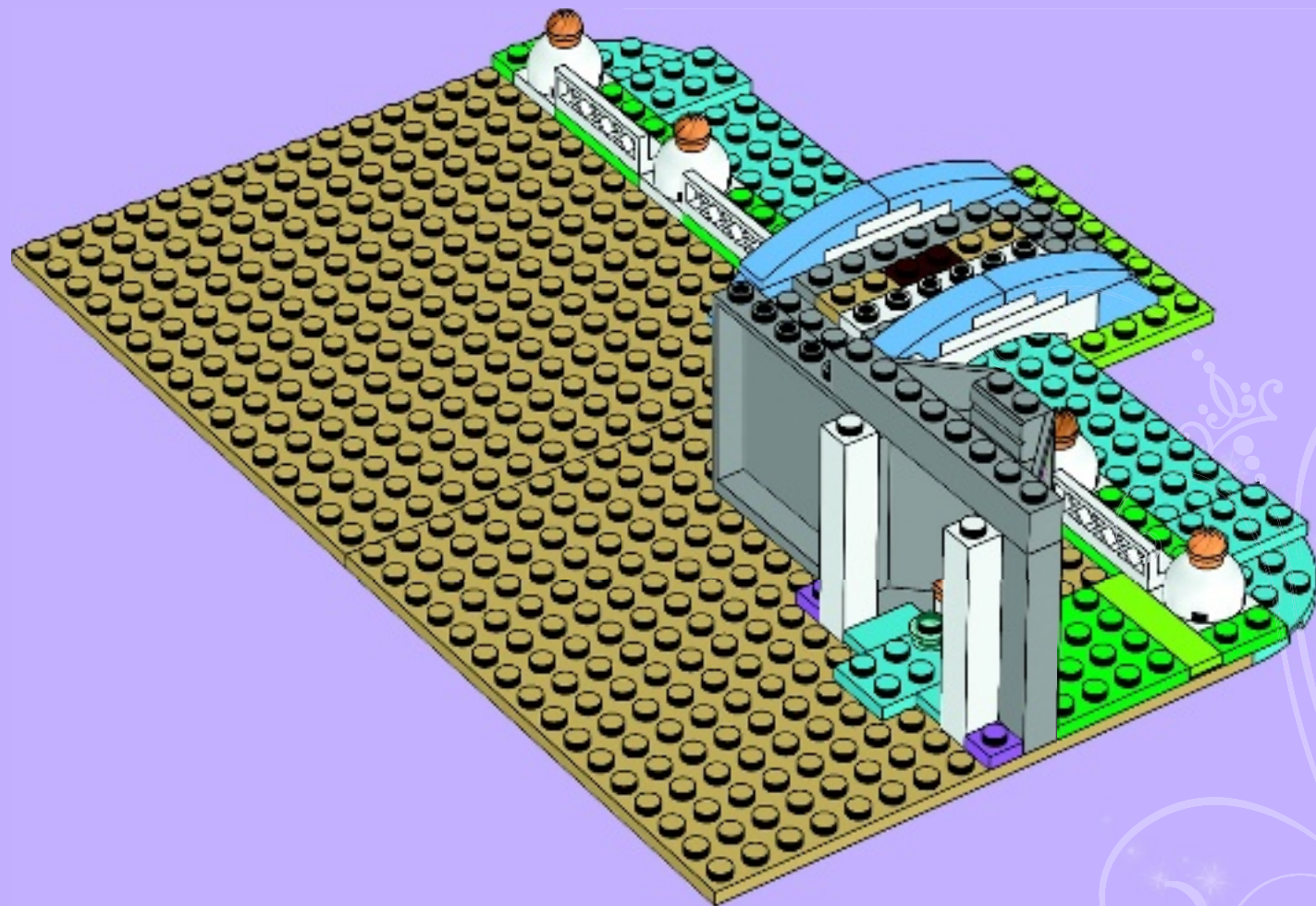

21

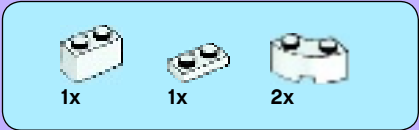

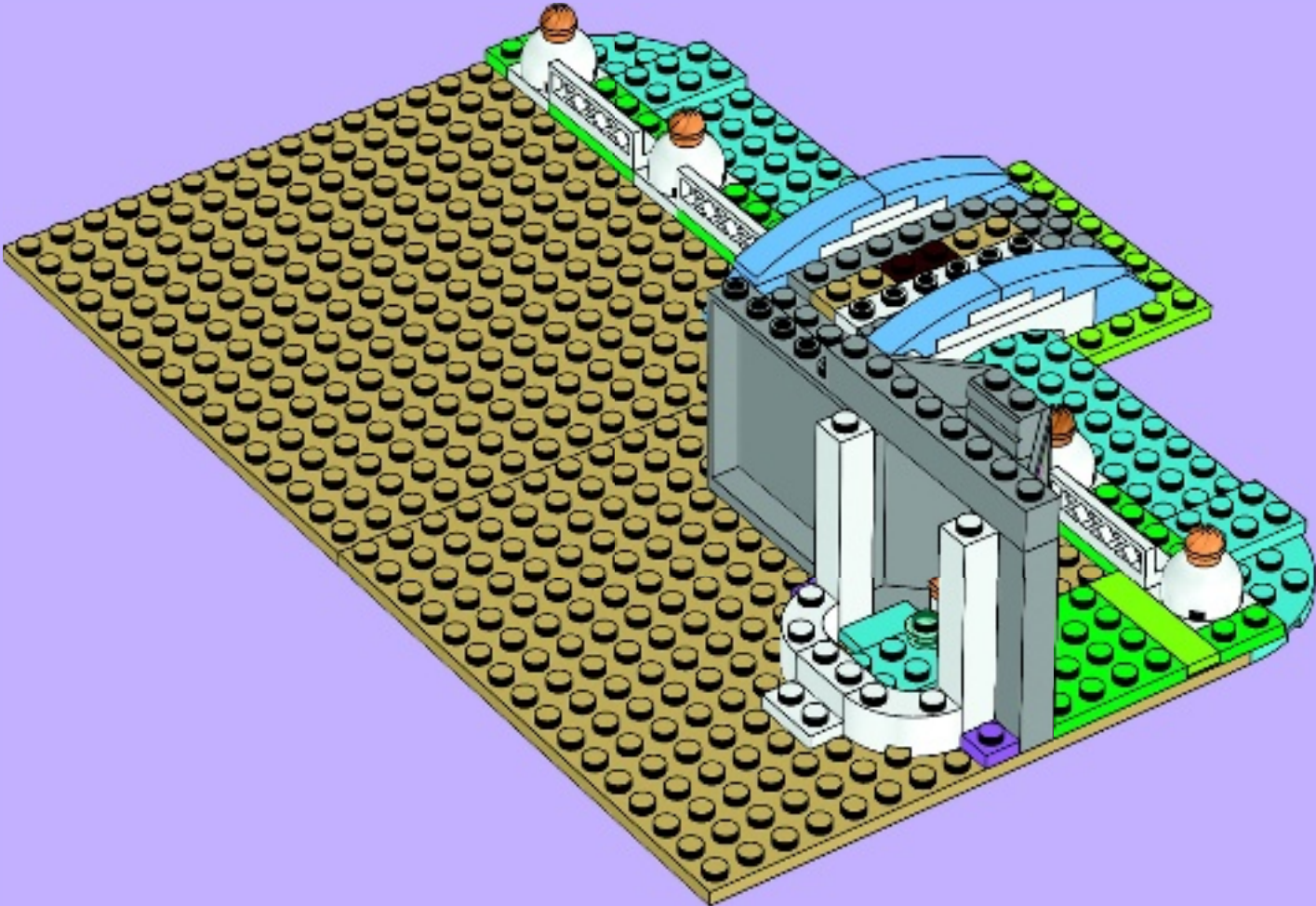

22



- 1x 
- 1x 
- 1x 
- 1x 

23

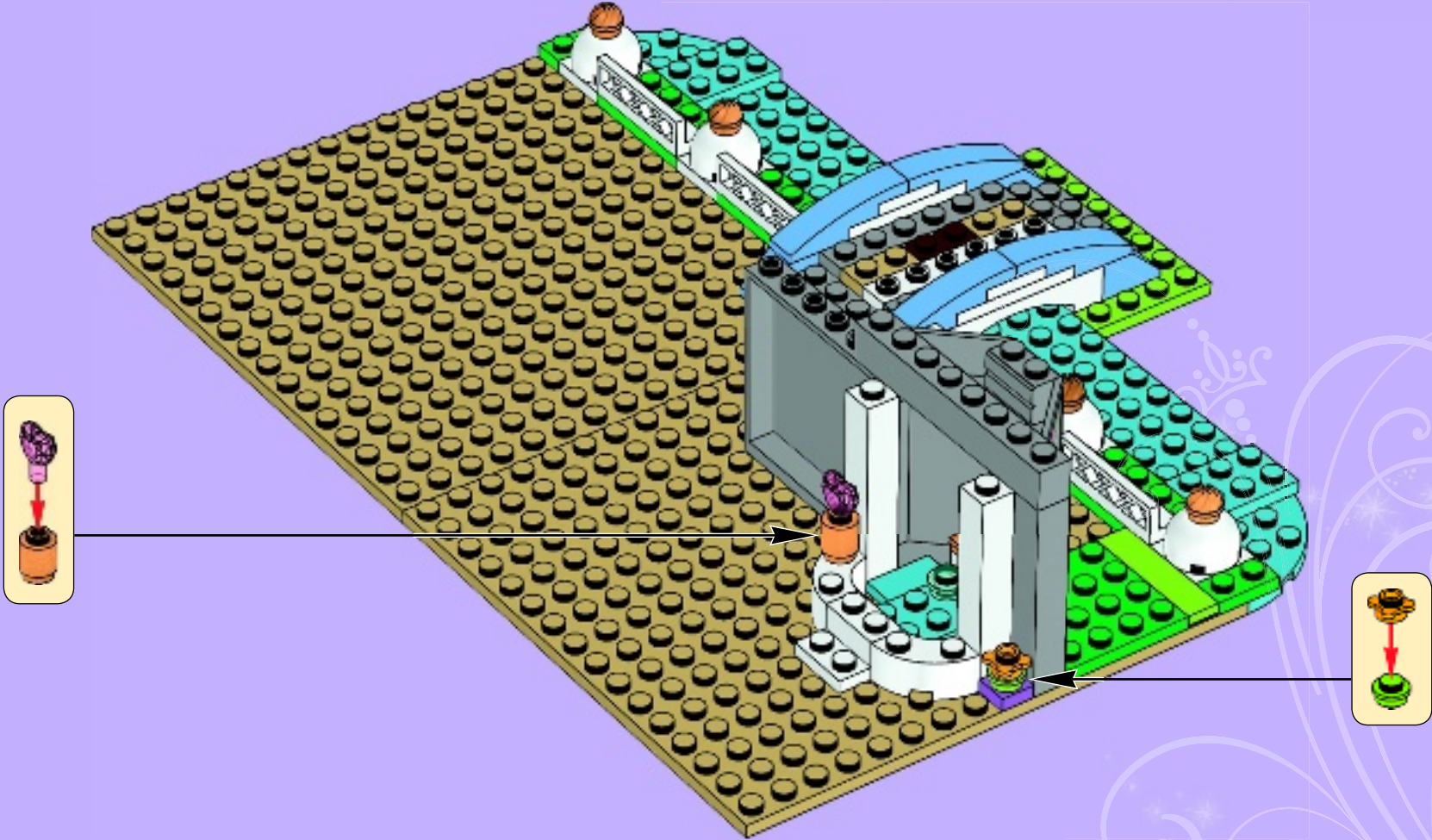

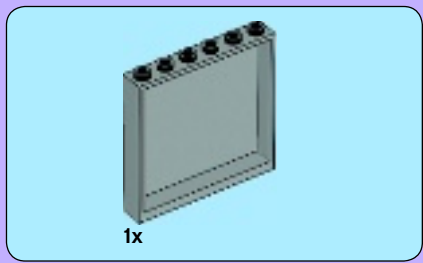

24

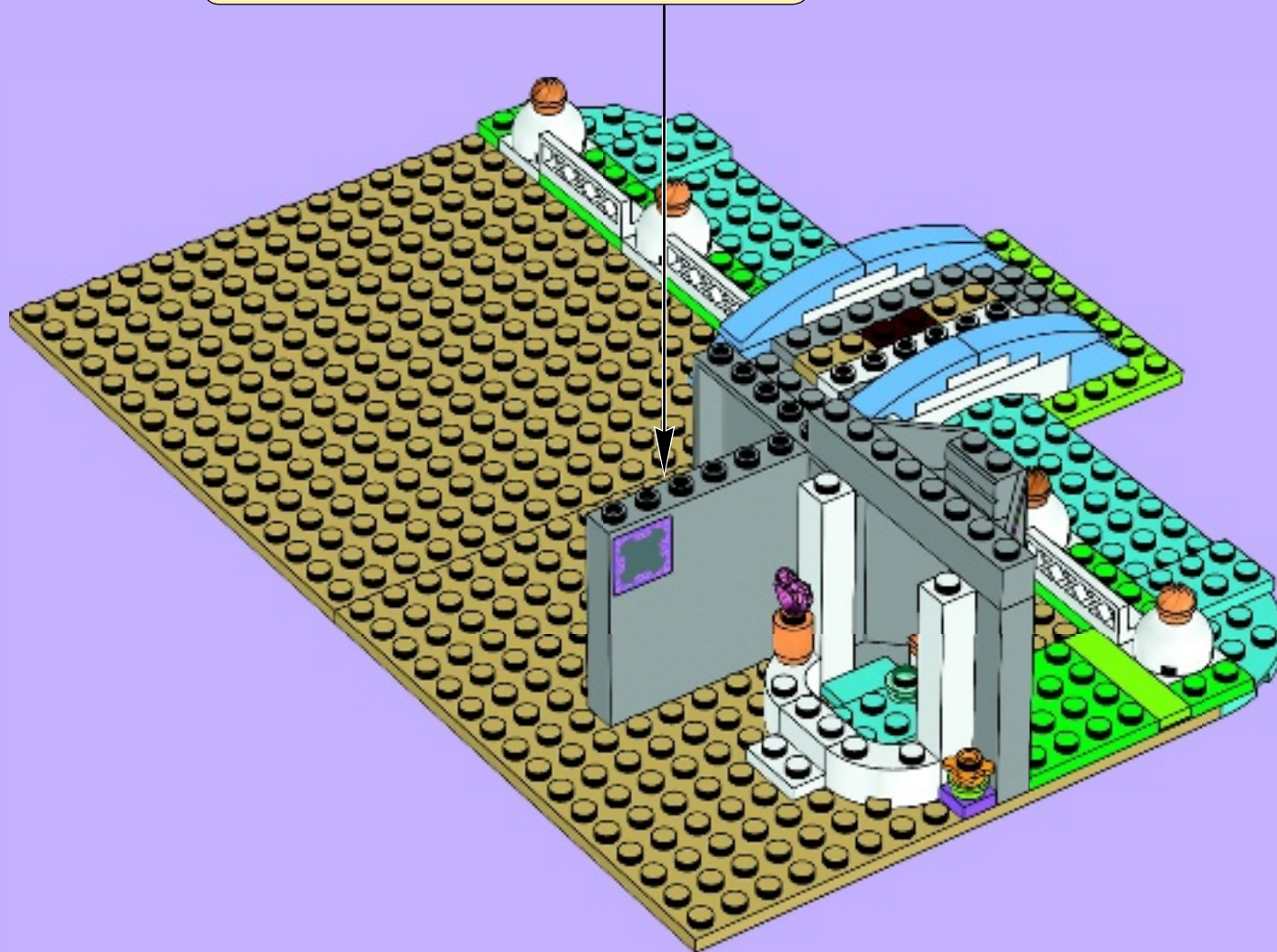
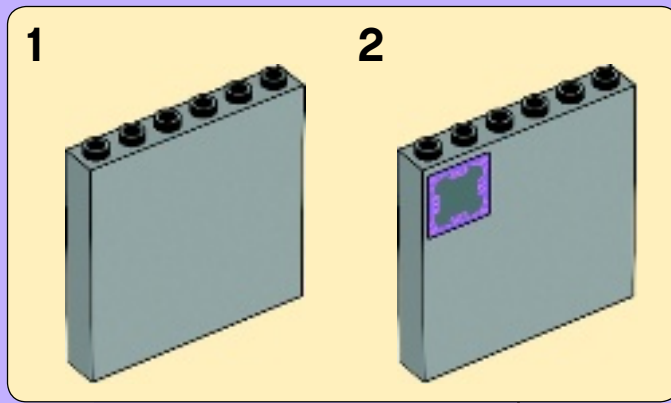



25

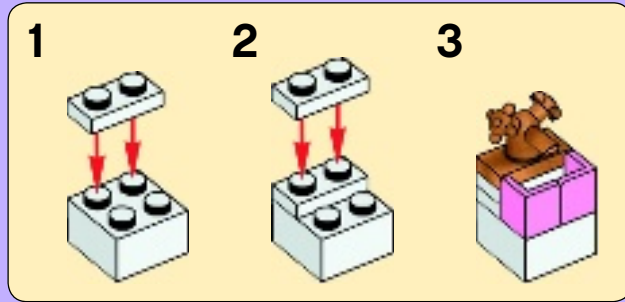

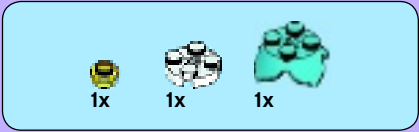

26



- 1x 
- 1x 
- 1x 
- 1x 

27

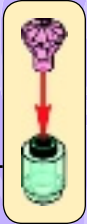



28

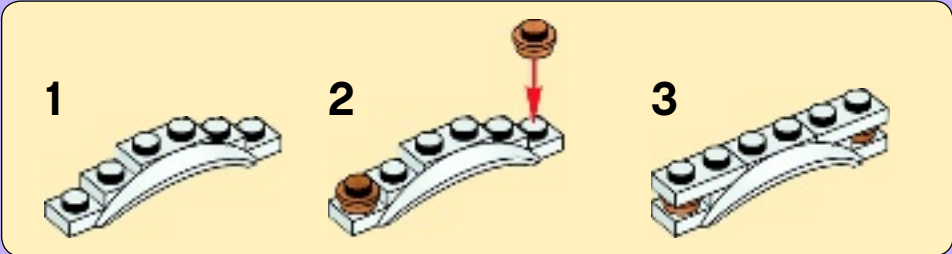

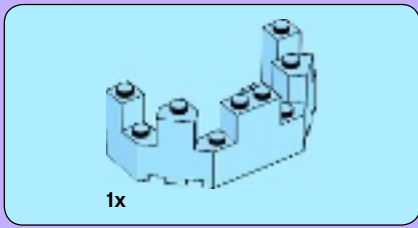

29



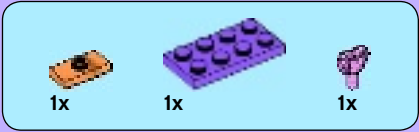

30



3x 1x 1x 2x

31

1 2



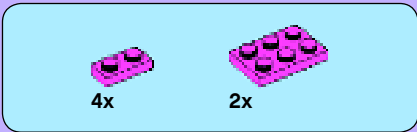

32

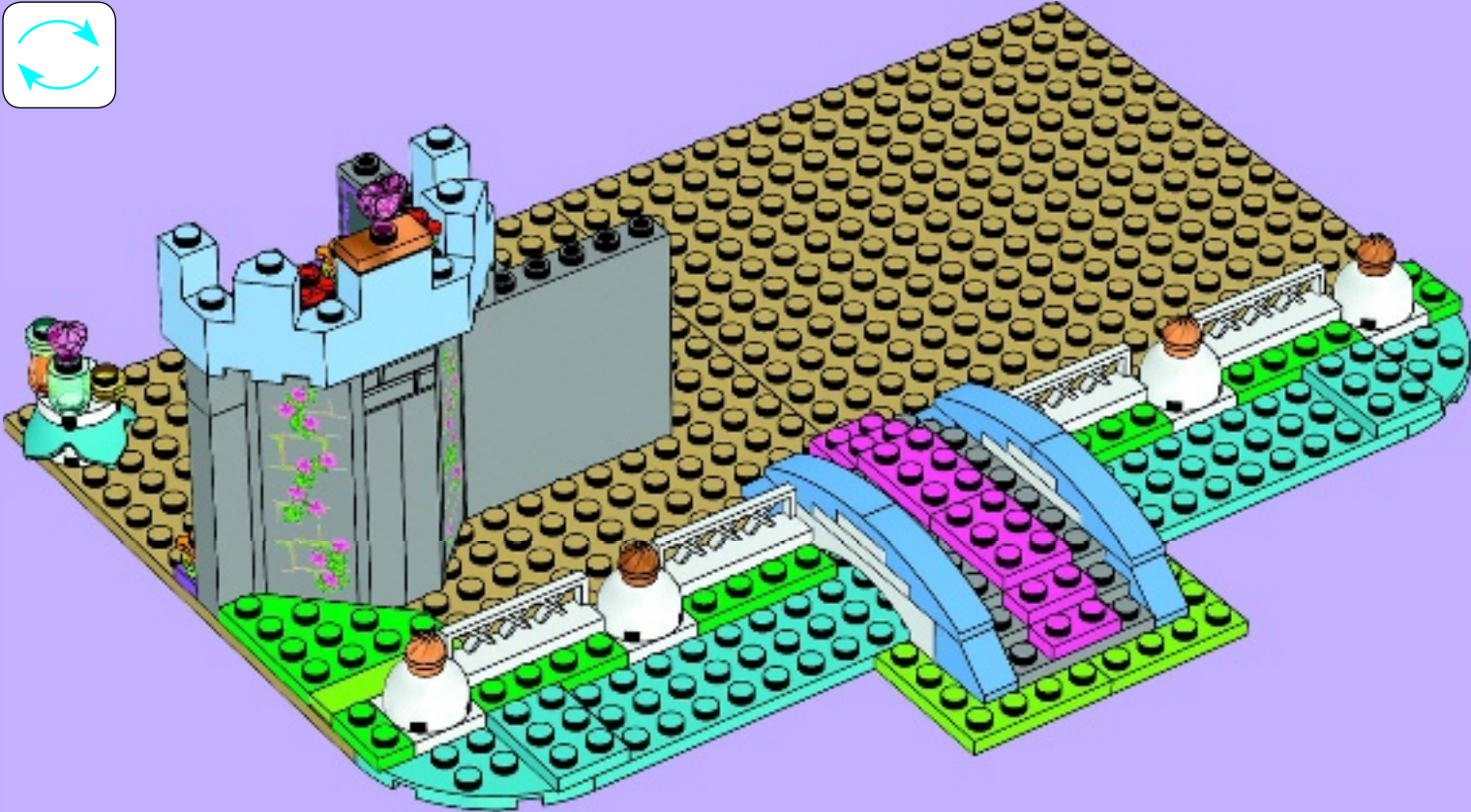



1x

33

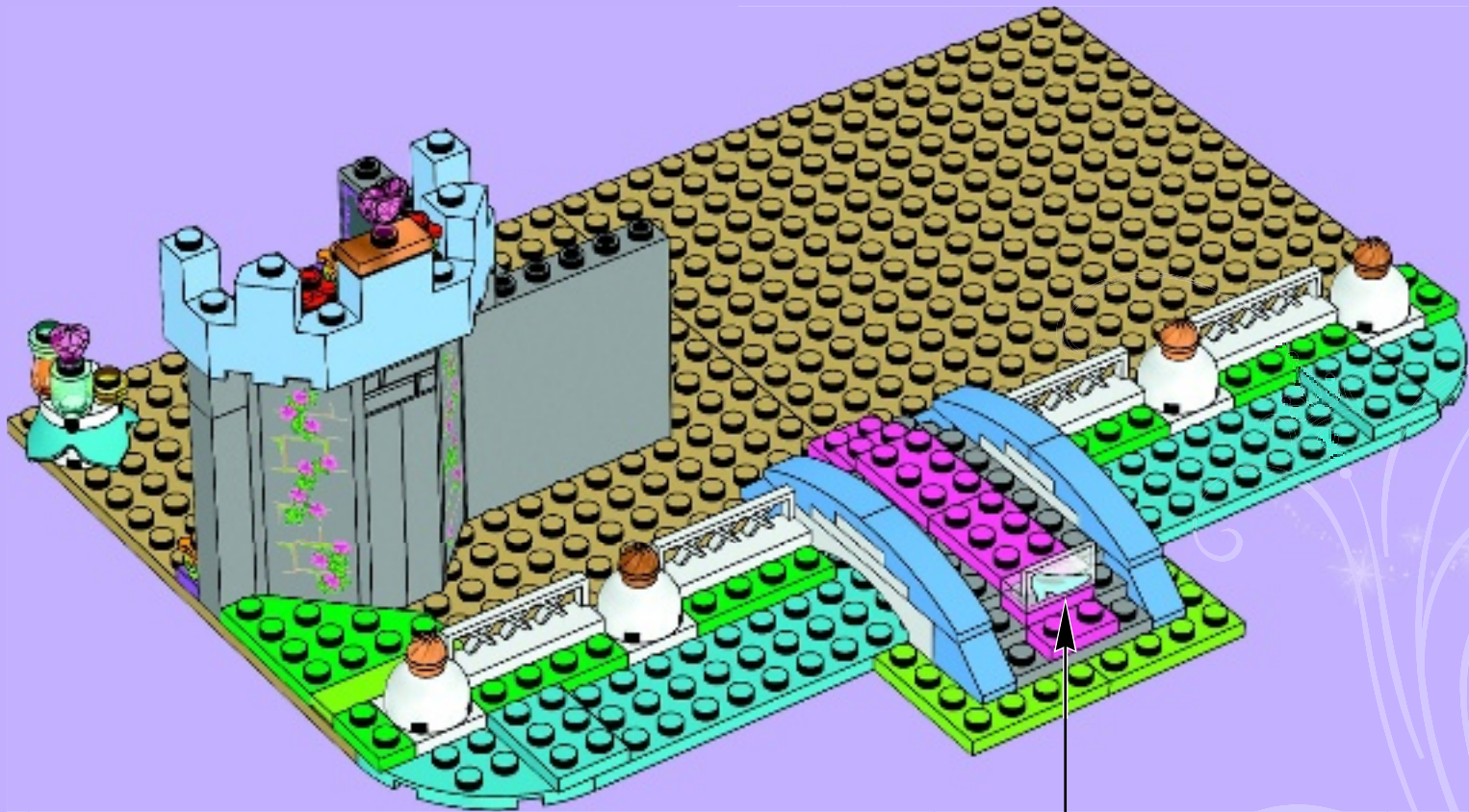

1



2



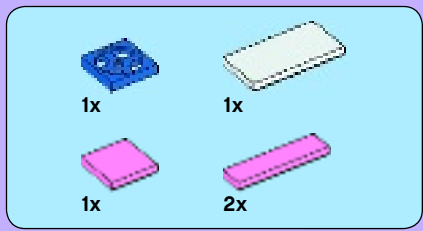

34

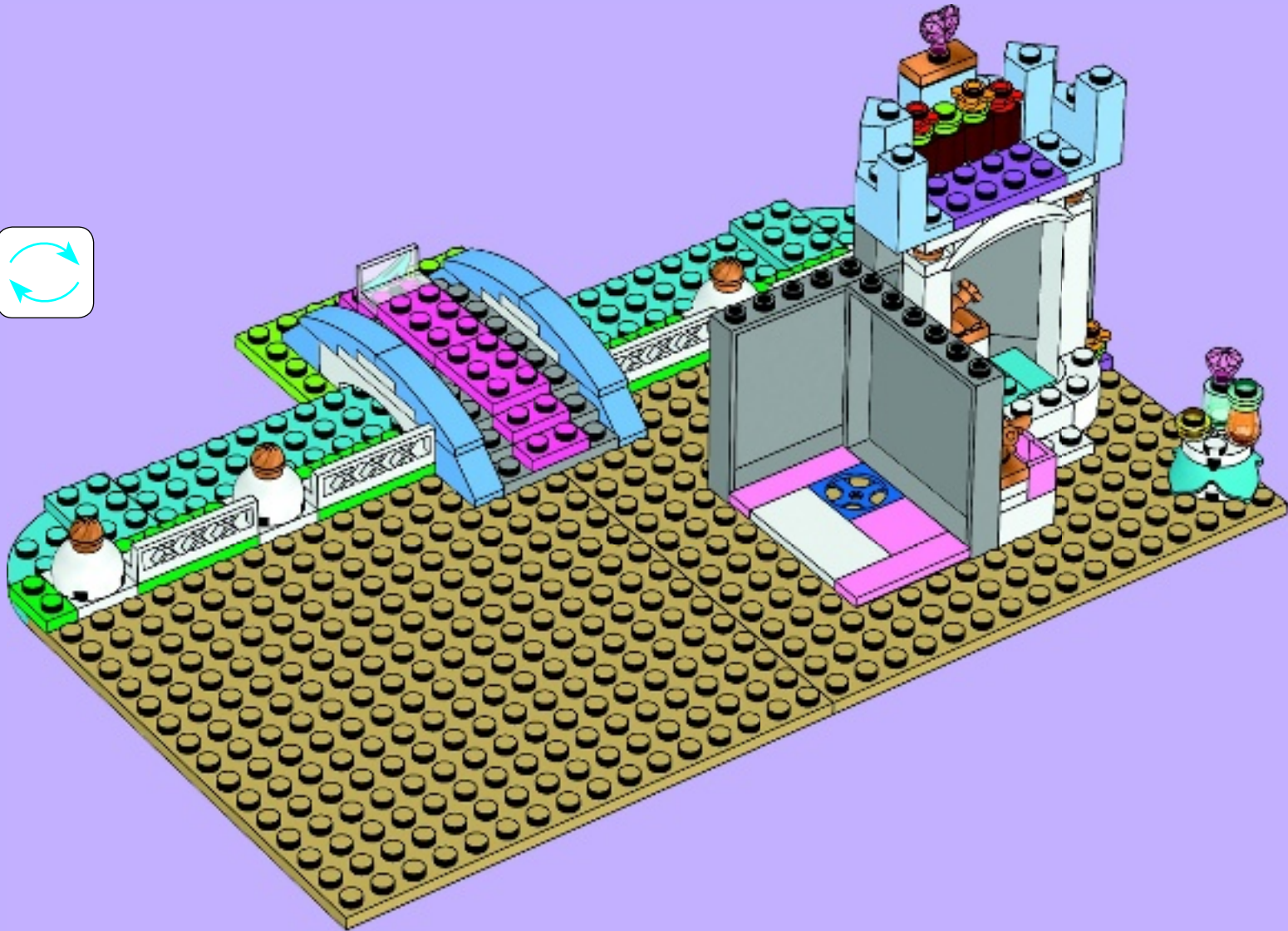



35

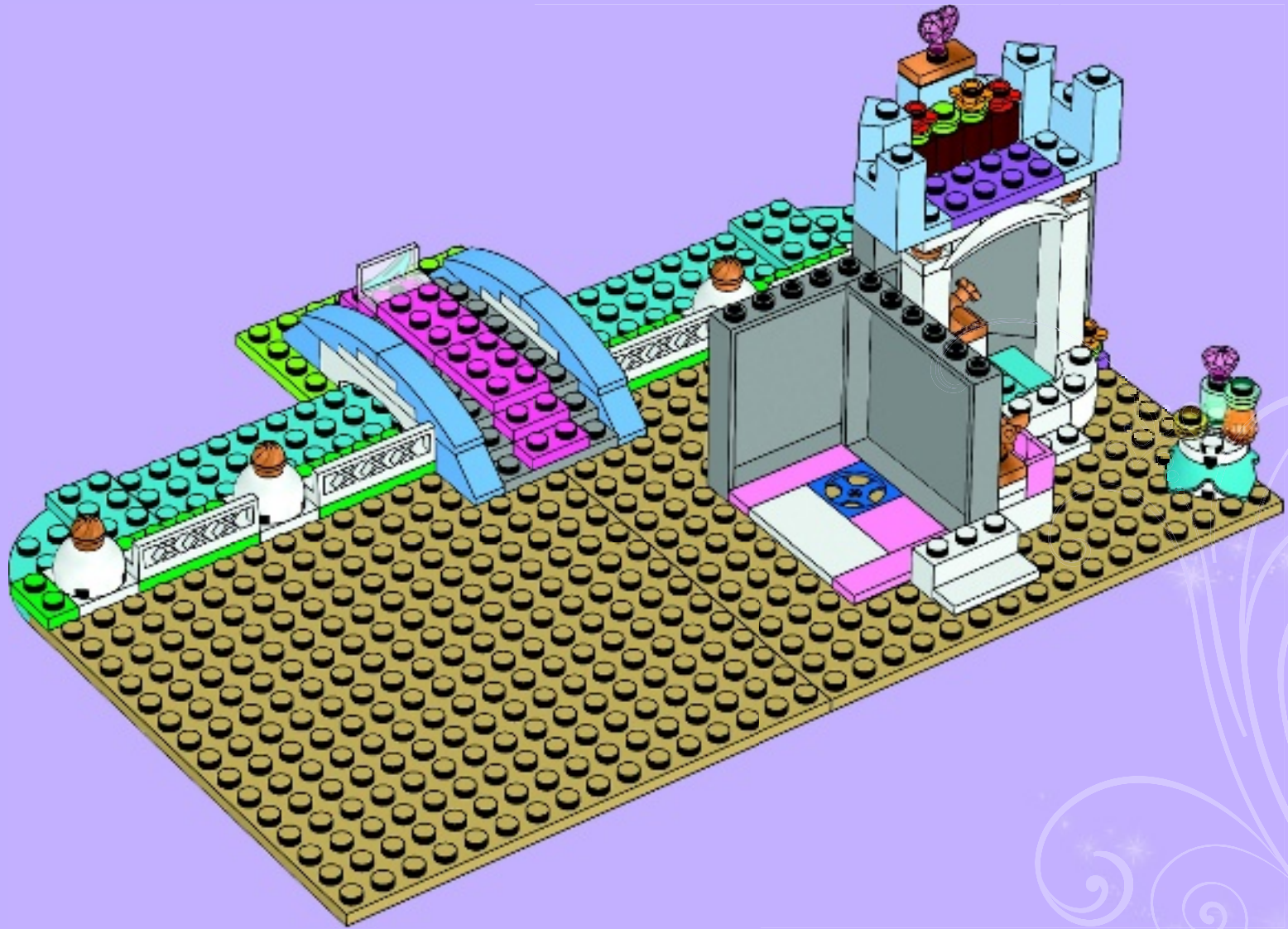

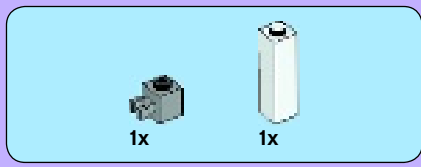

36

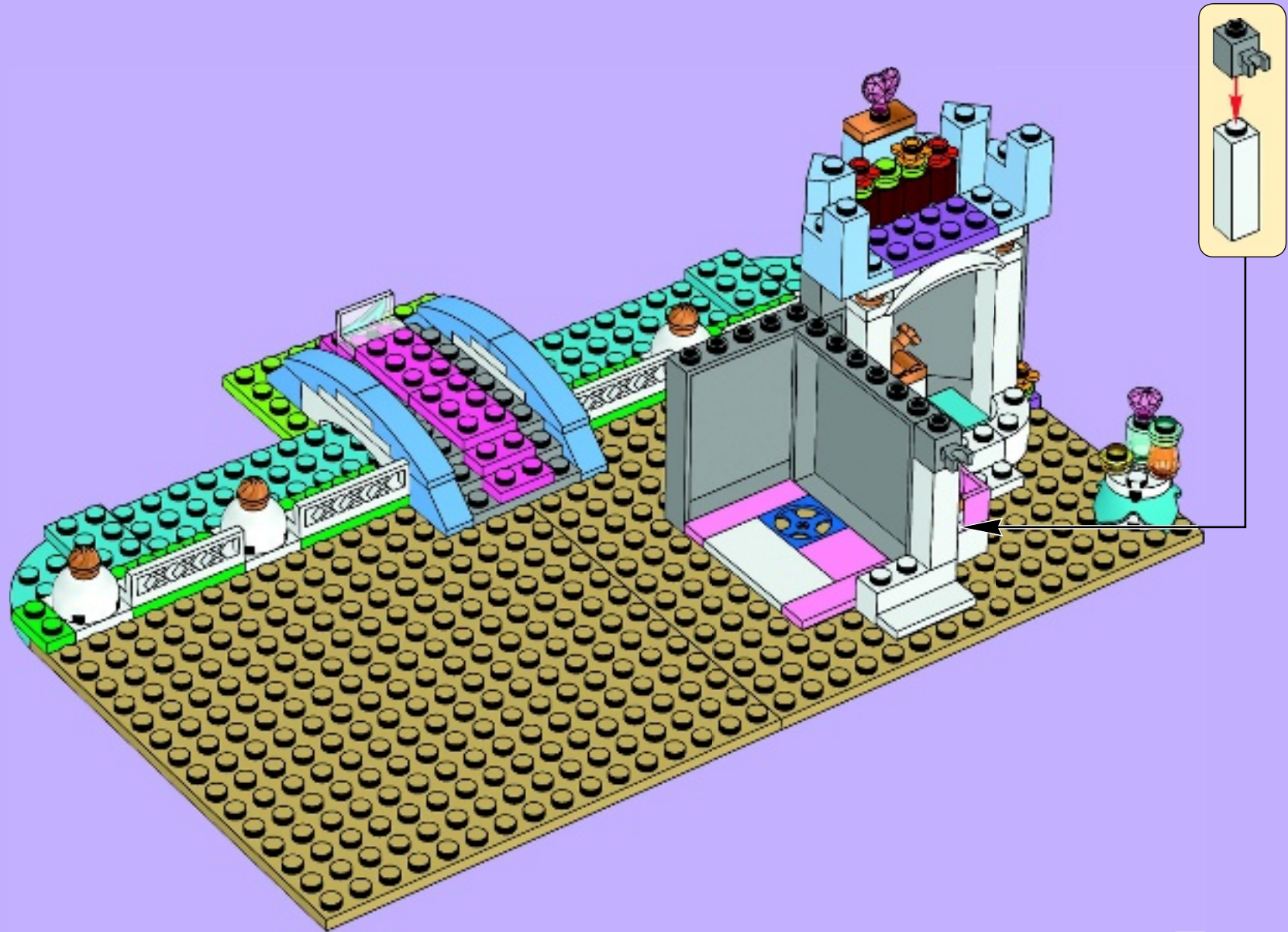



1

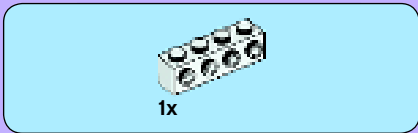

2



3



4

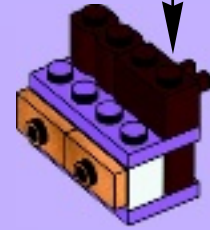

5

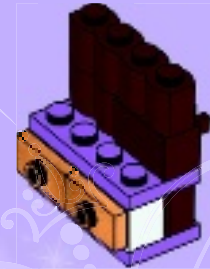

6

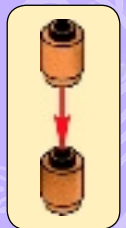



7

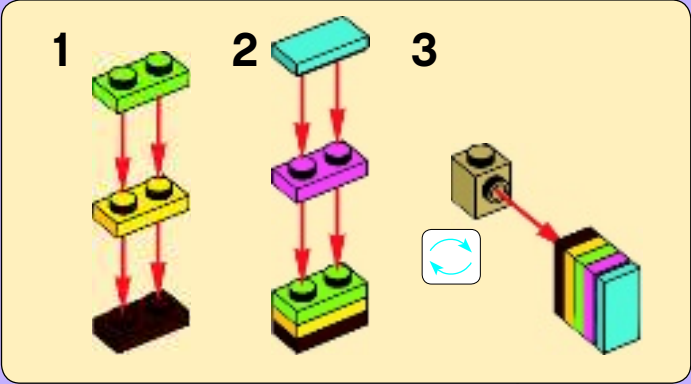

8

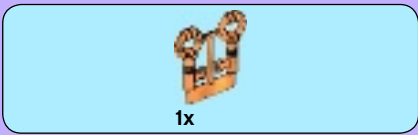

9

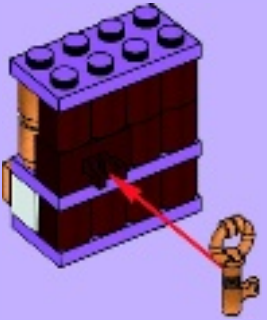

10

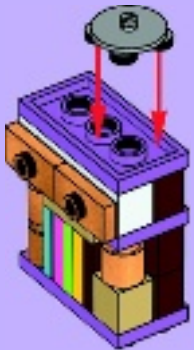

37

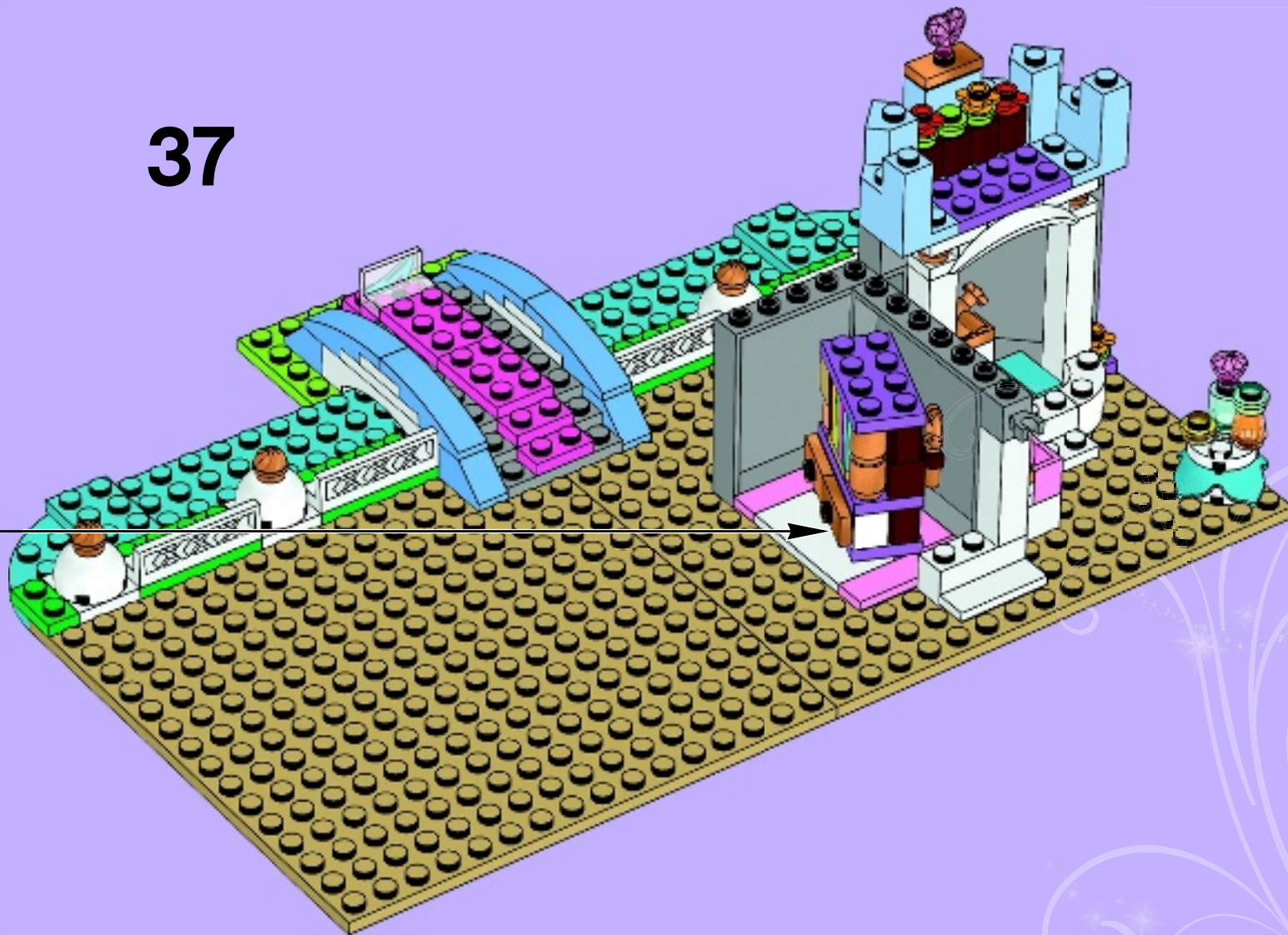

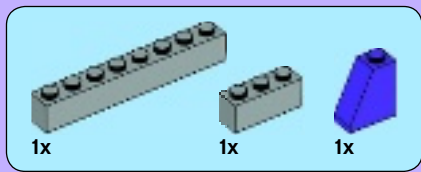

38

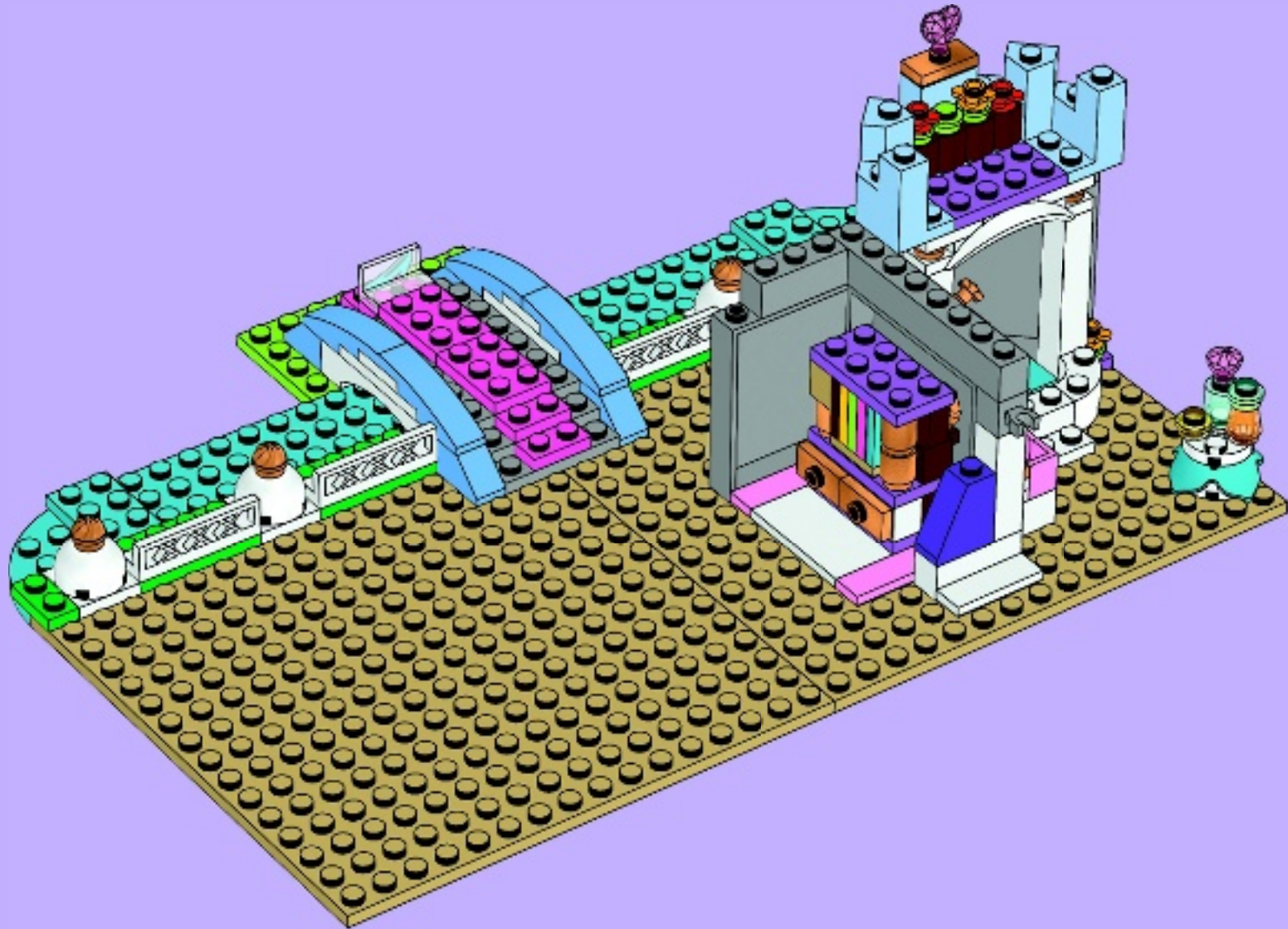

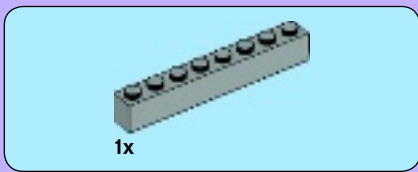

39

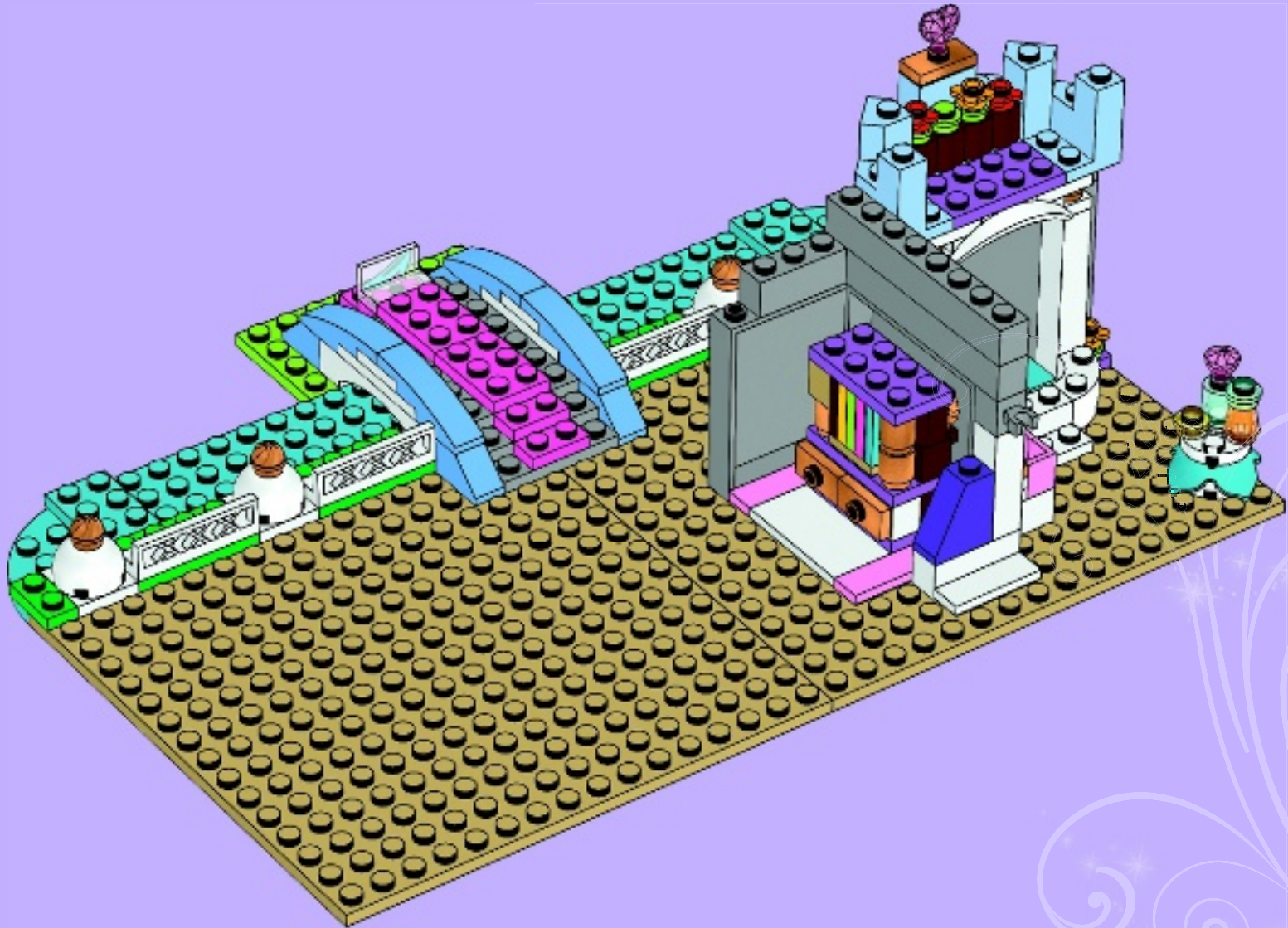

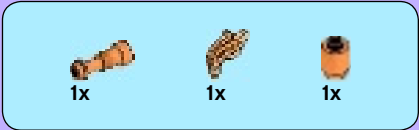

40

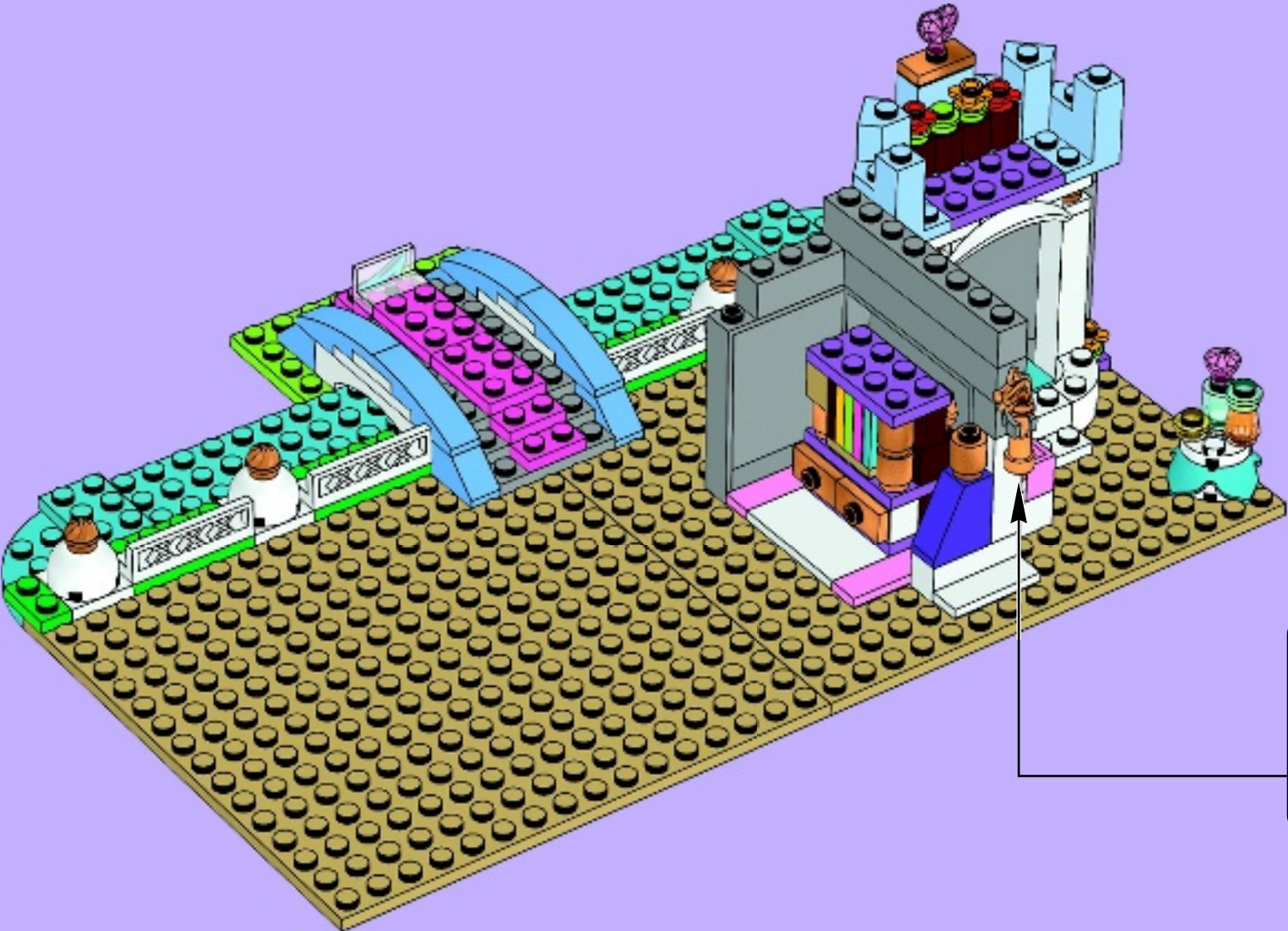



41

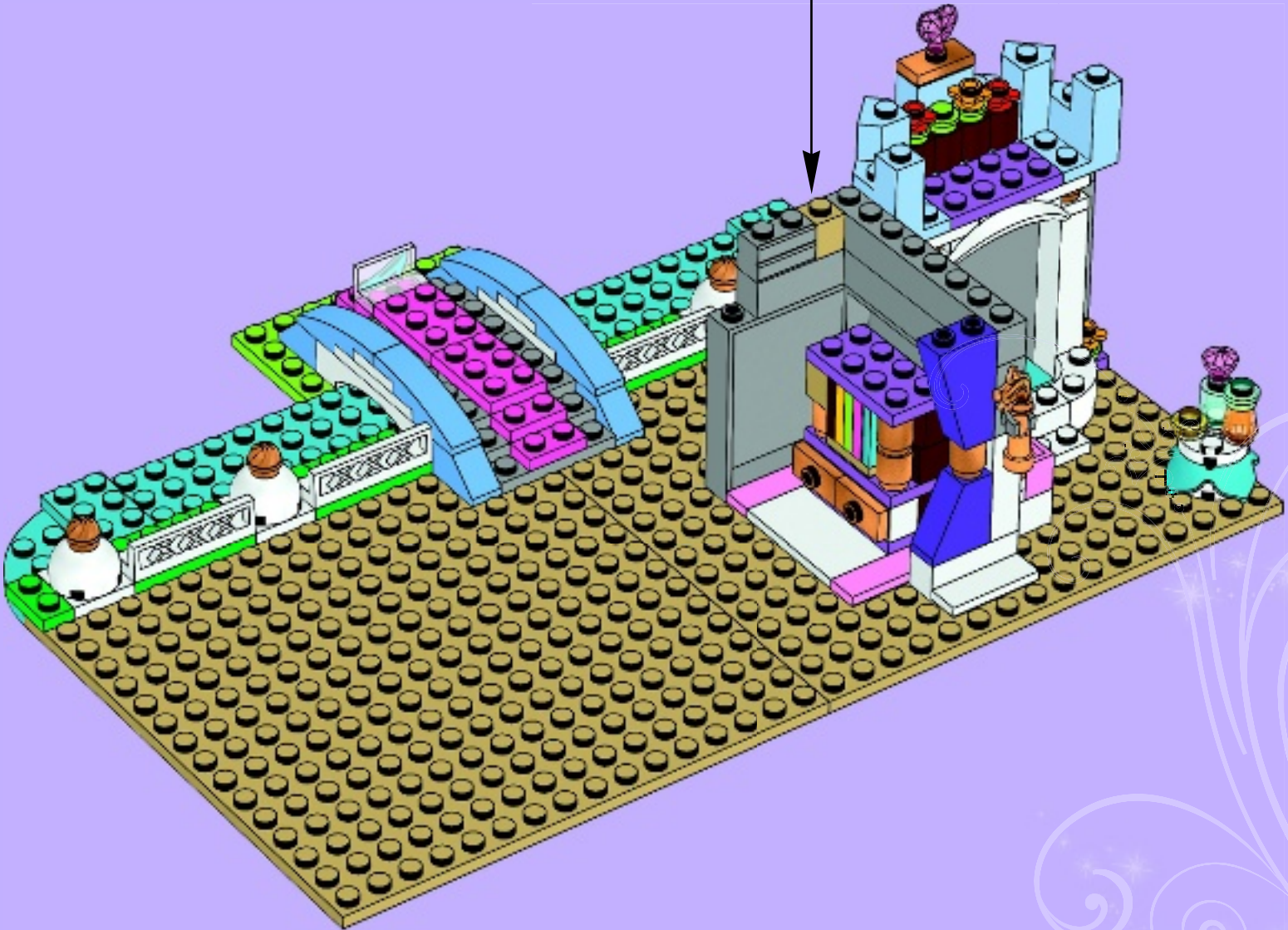

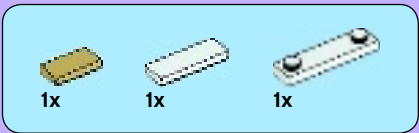

42

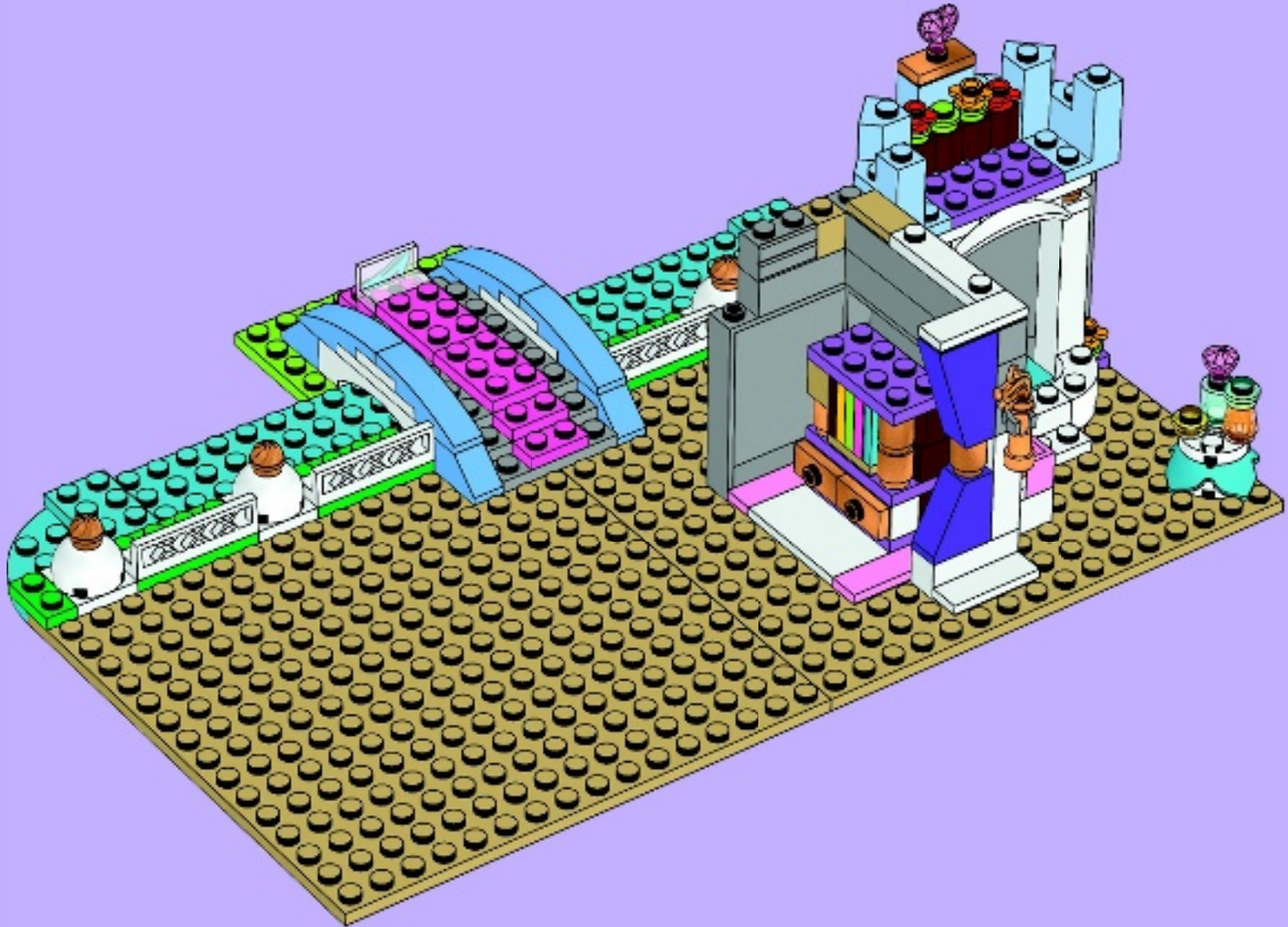



43

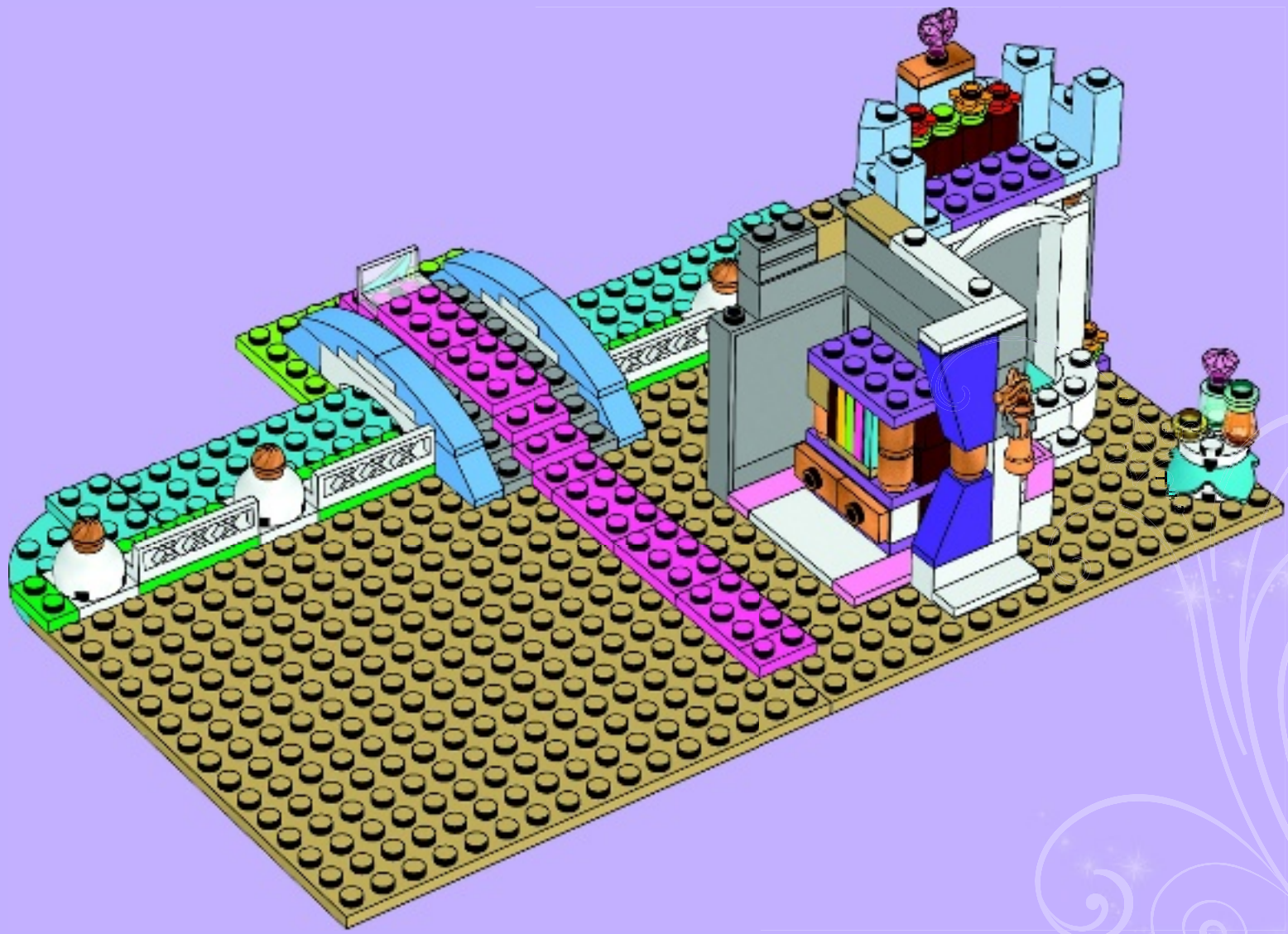

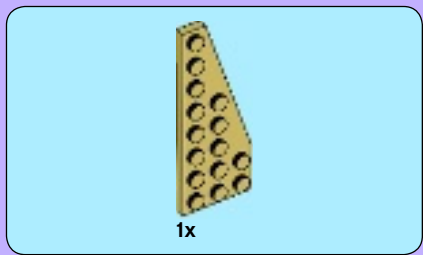

44

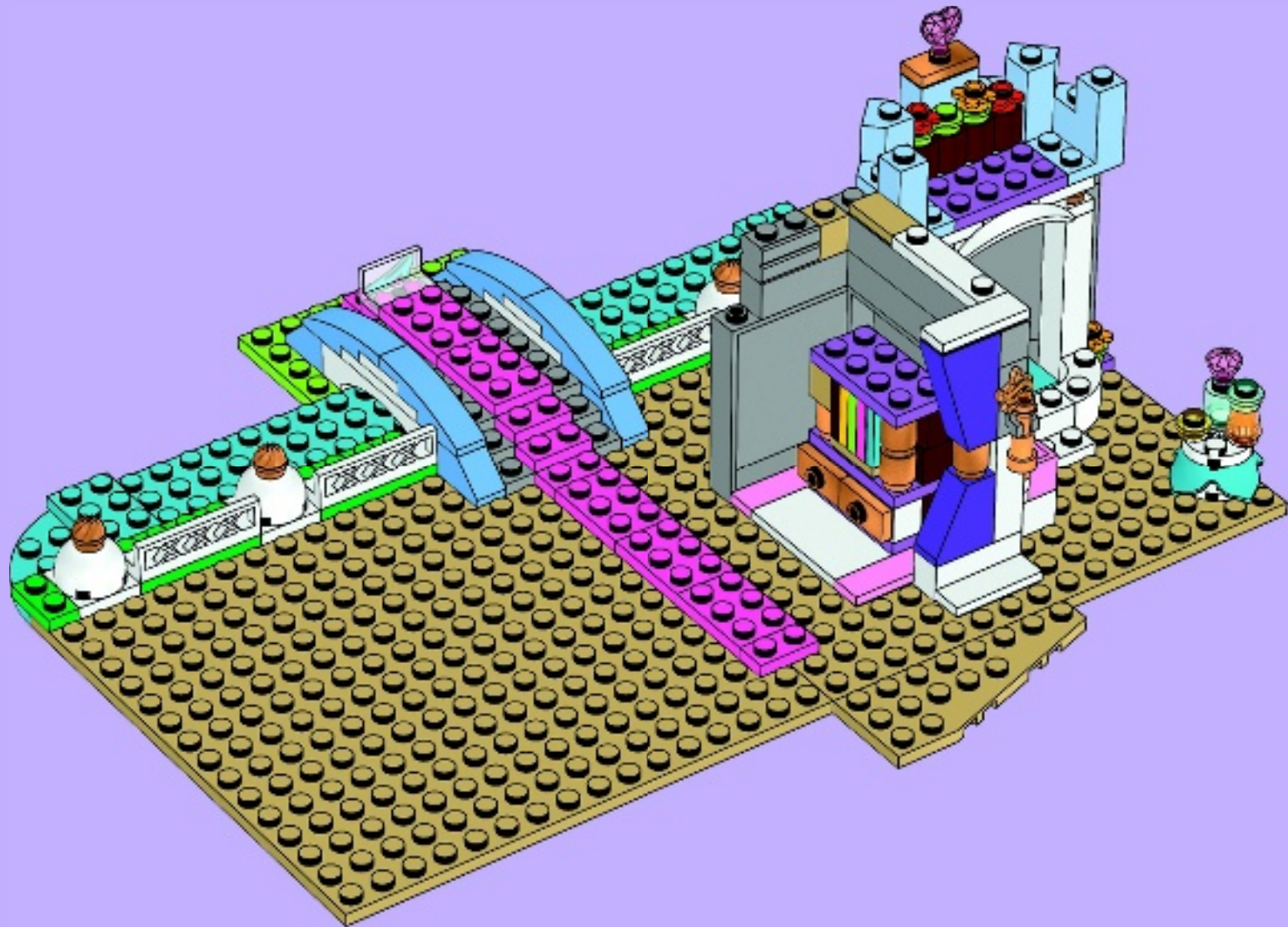

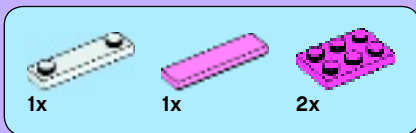

45

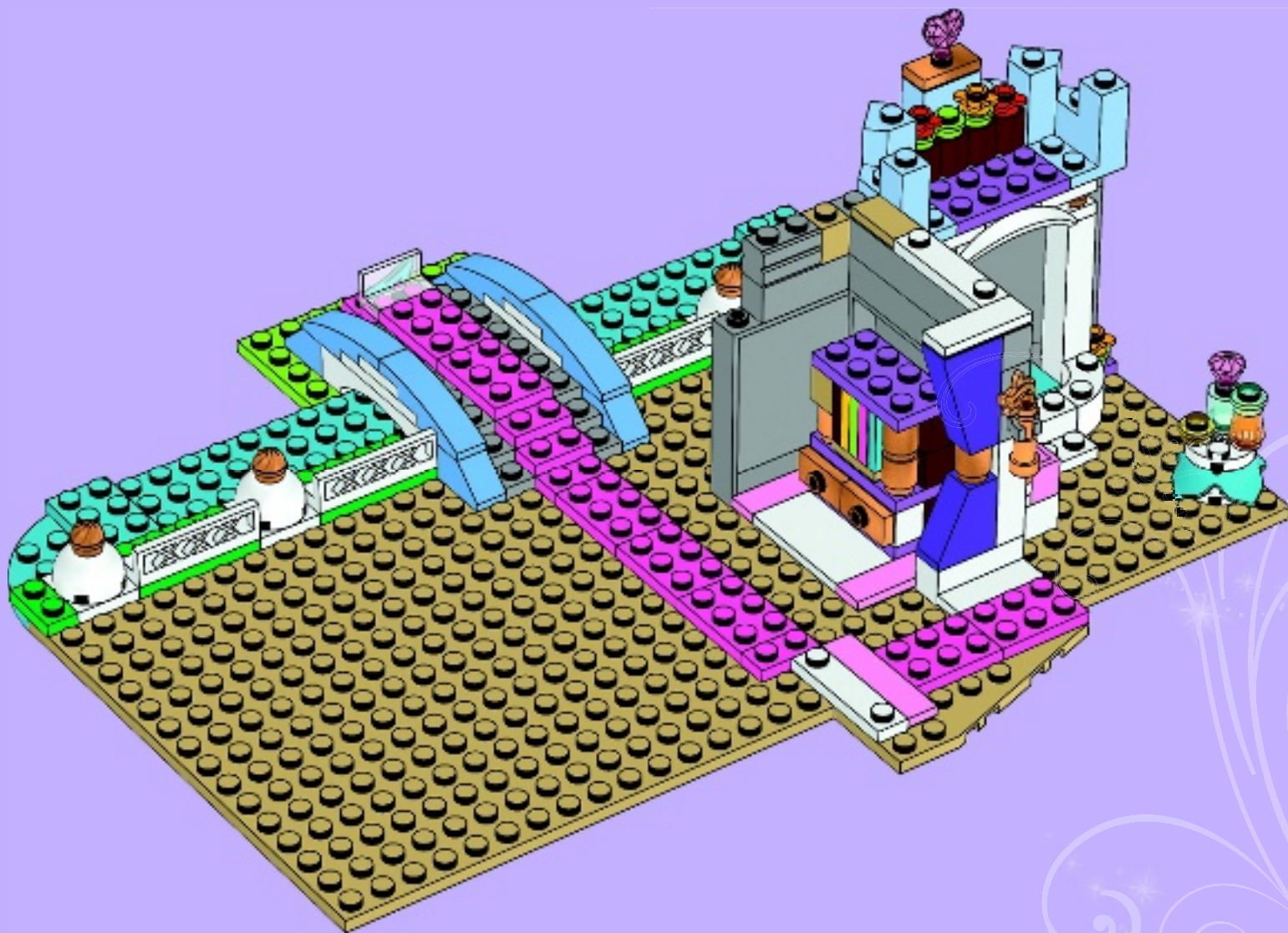

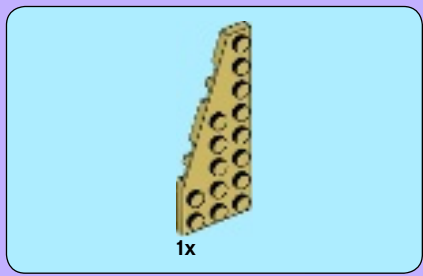

46

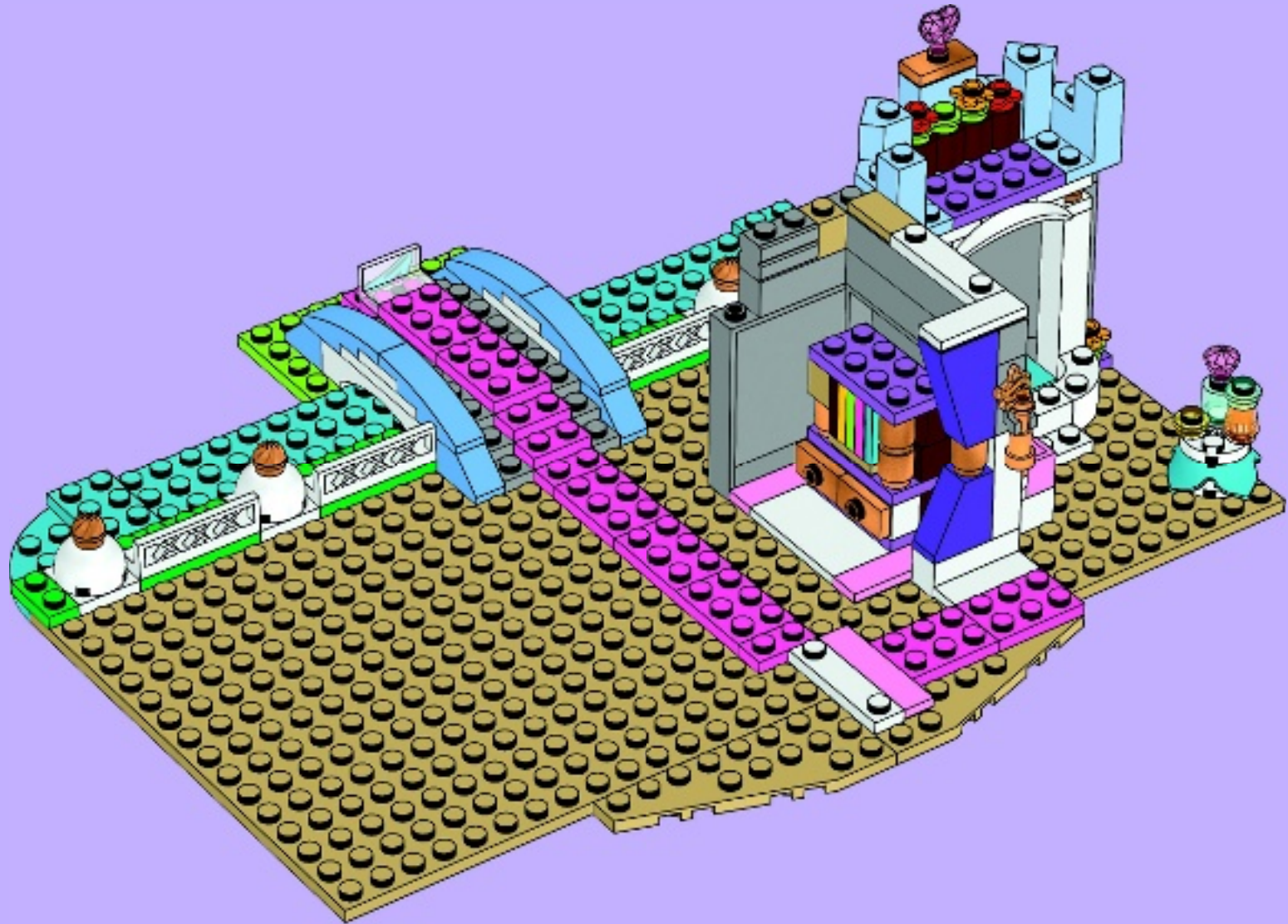

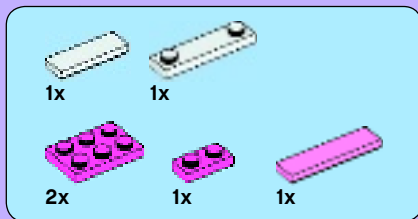

47

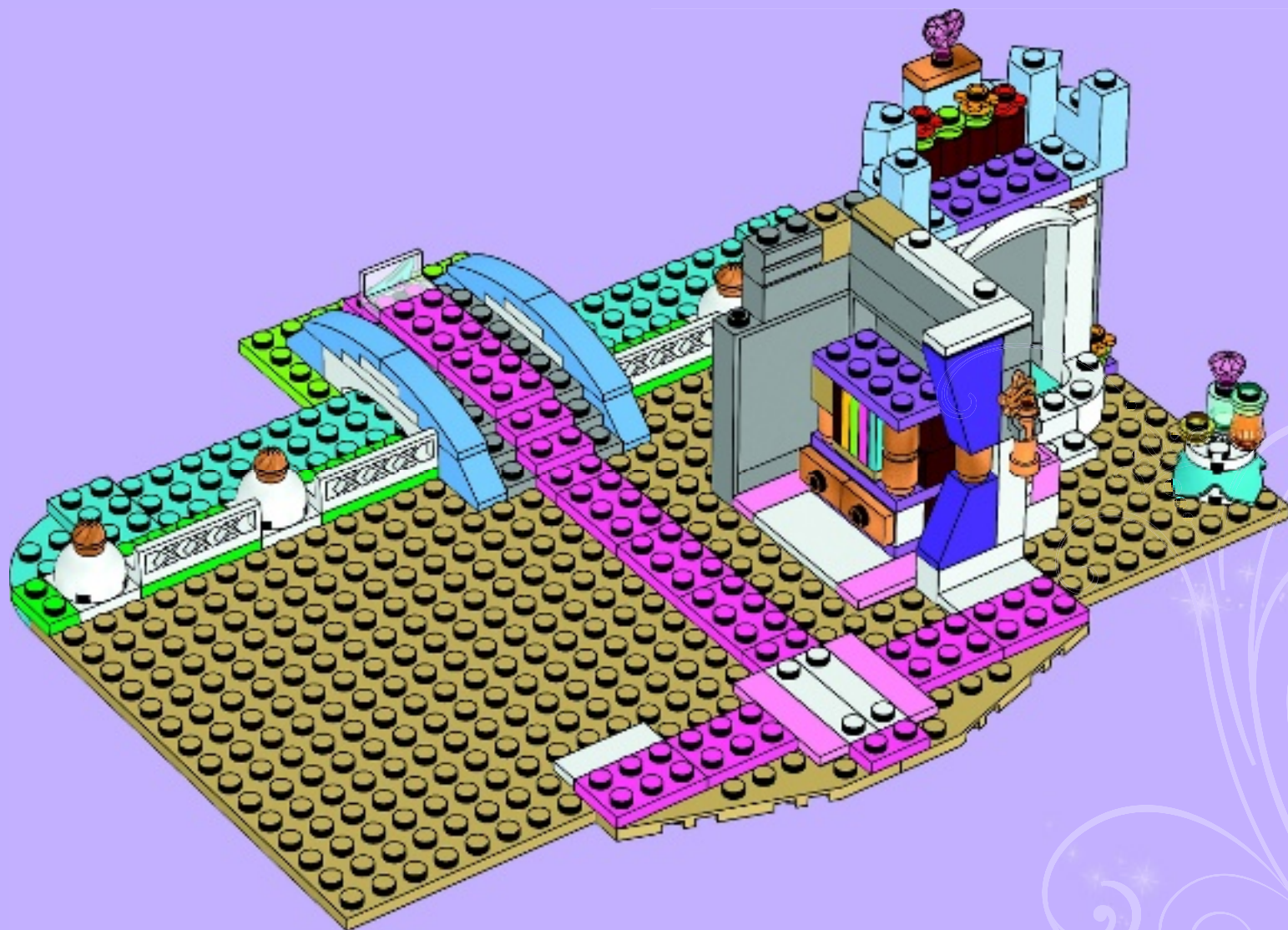

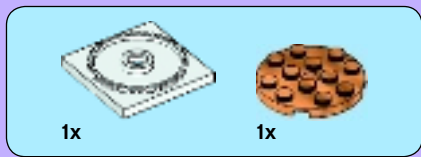

48

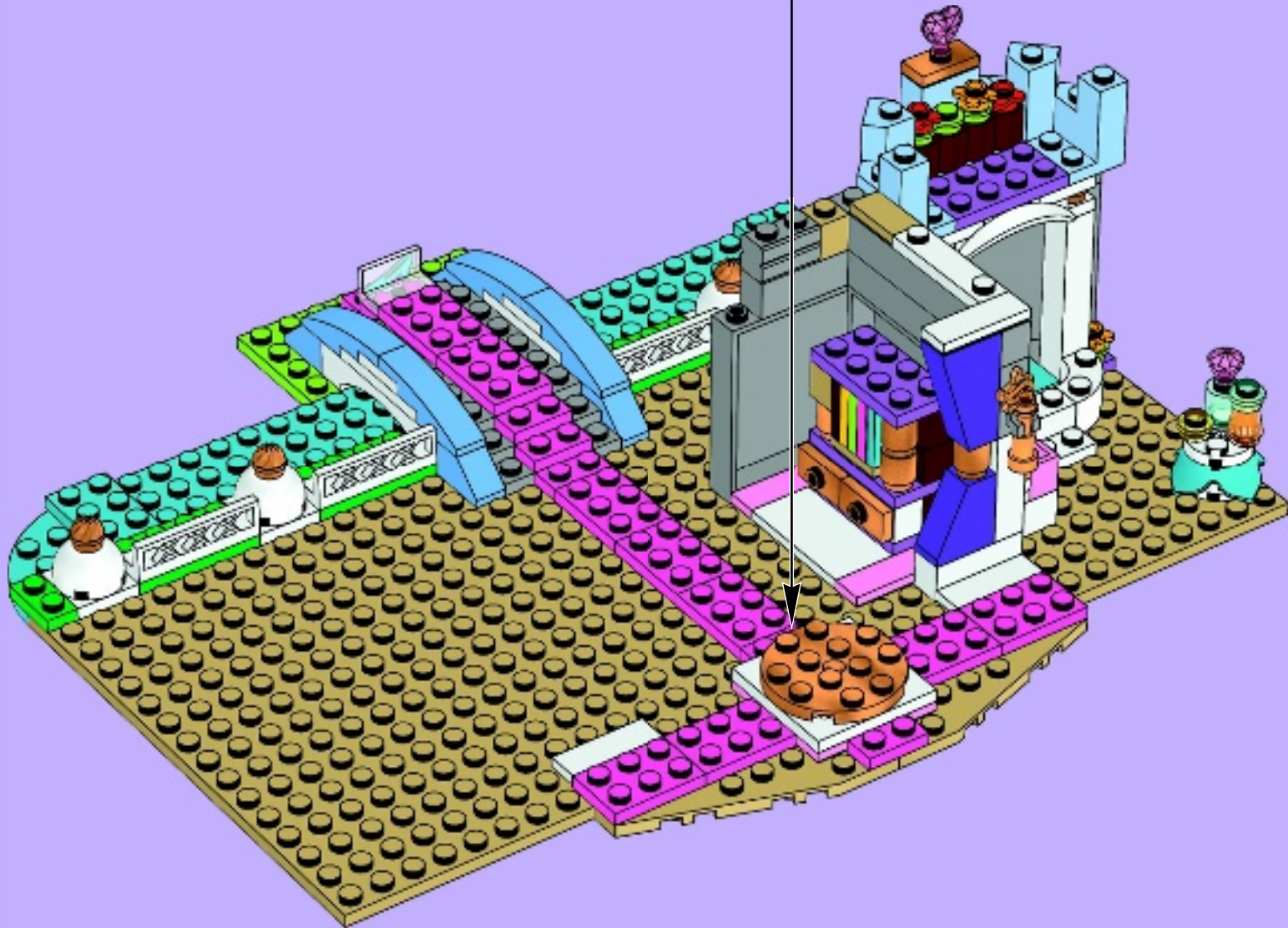
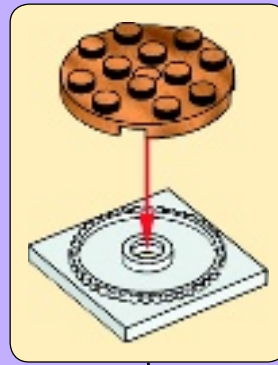

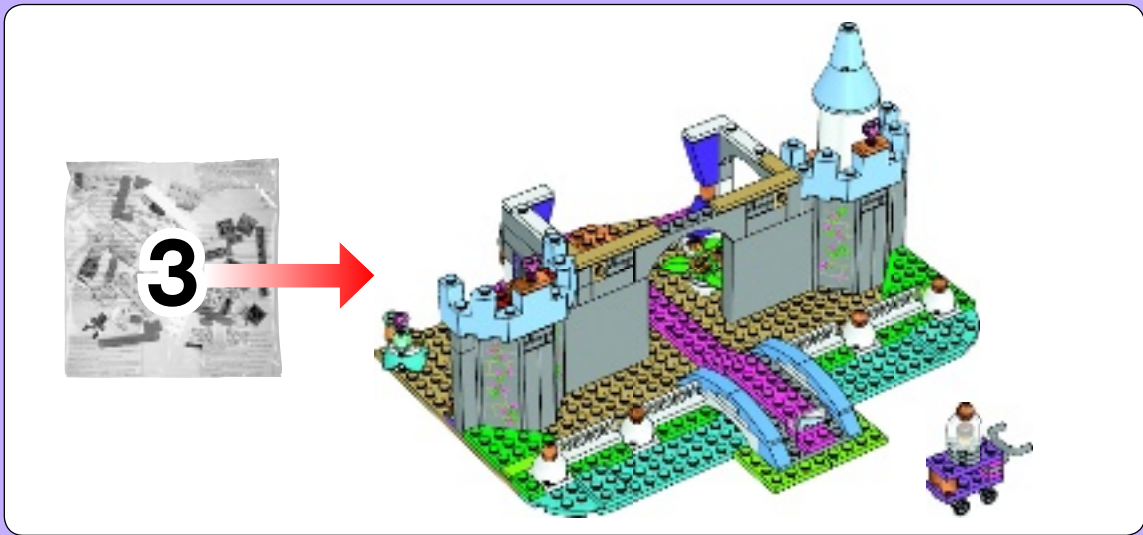

49



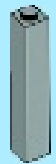

1x

50

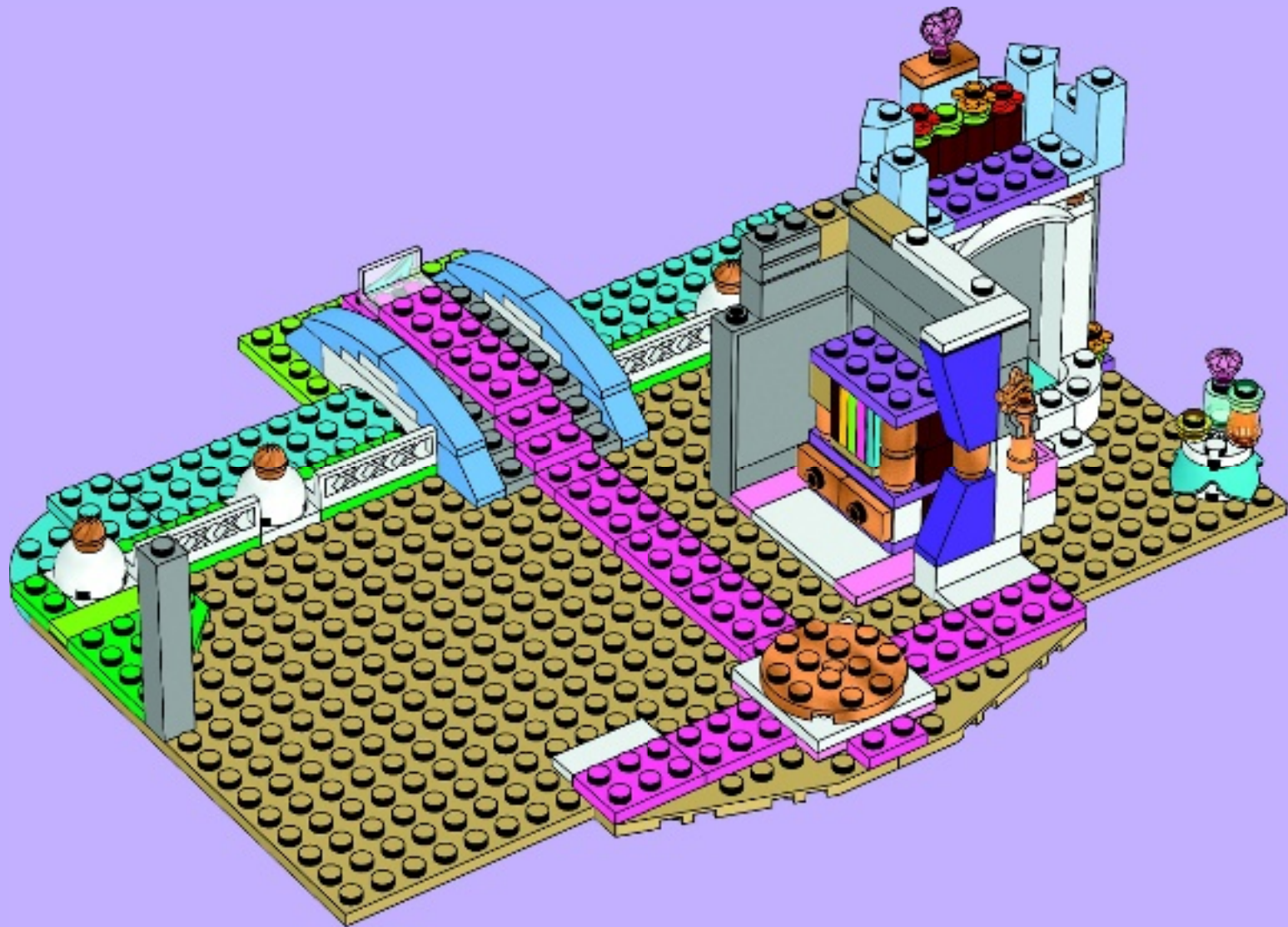

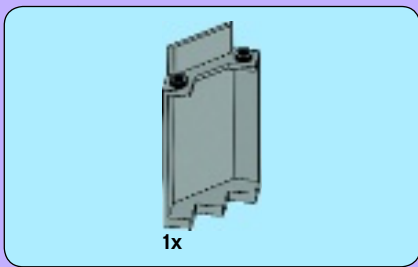

51

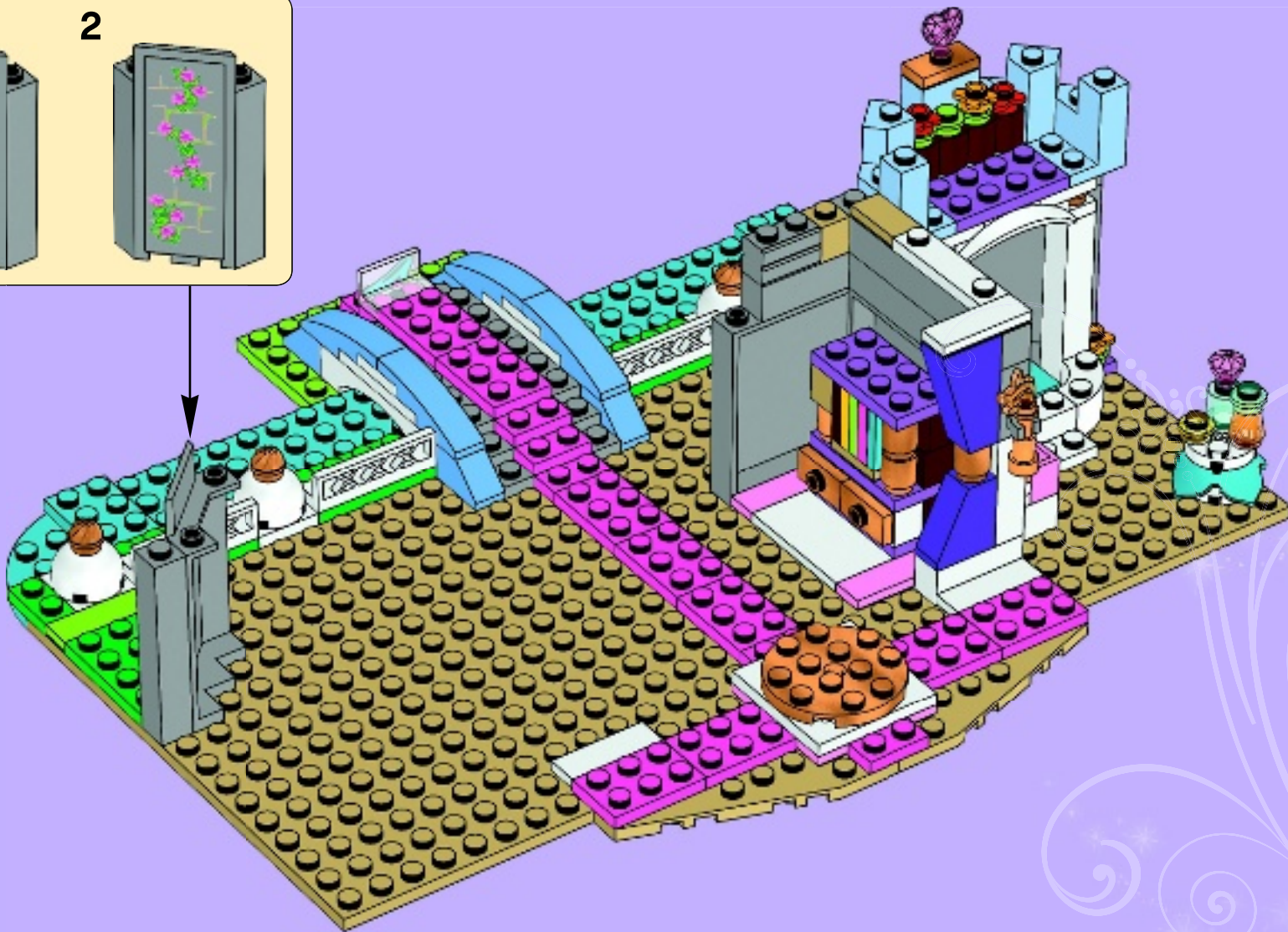
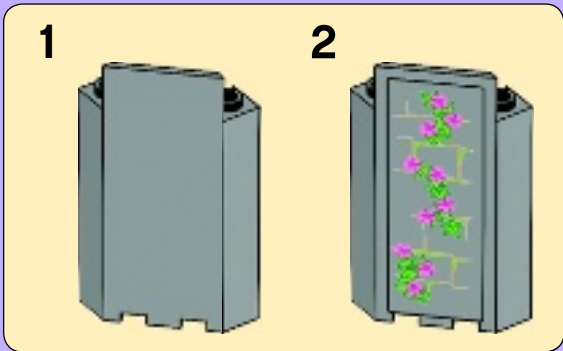

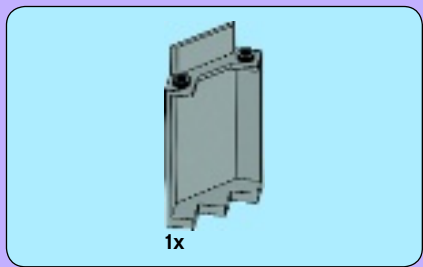

52

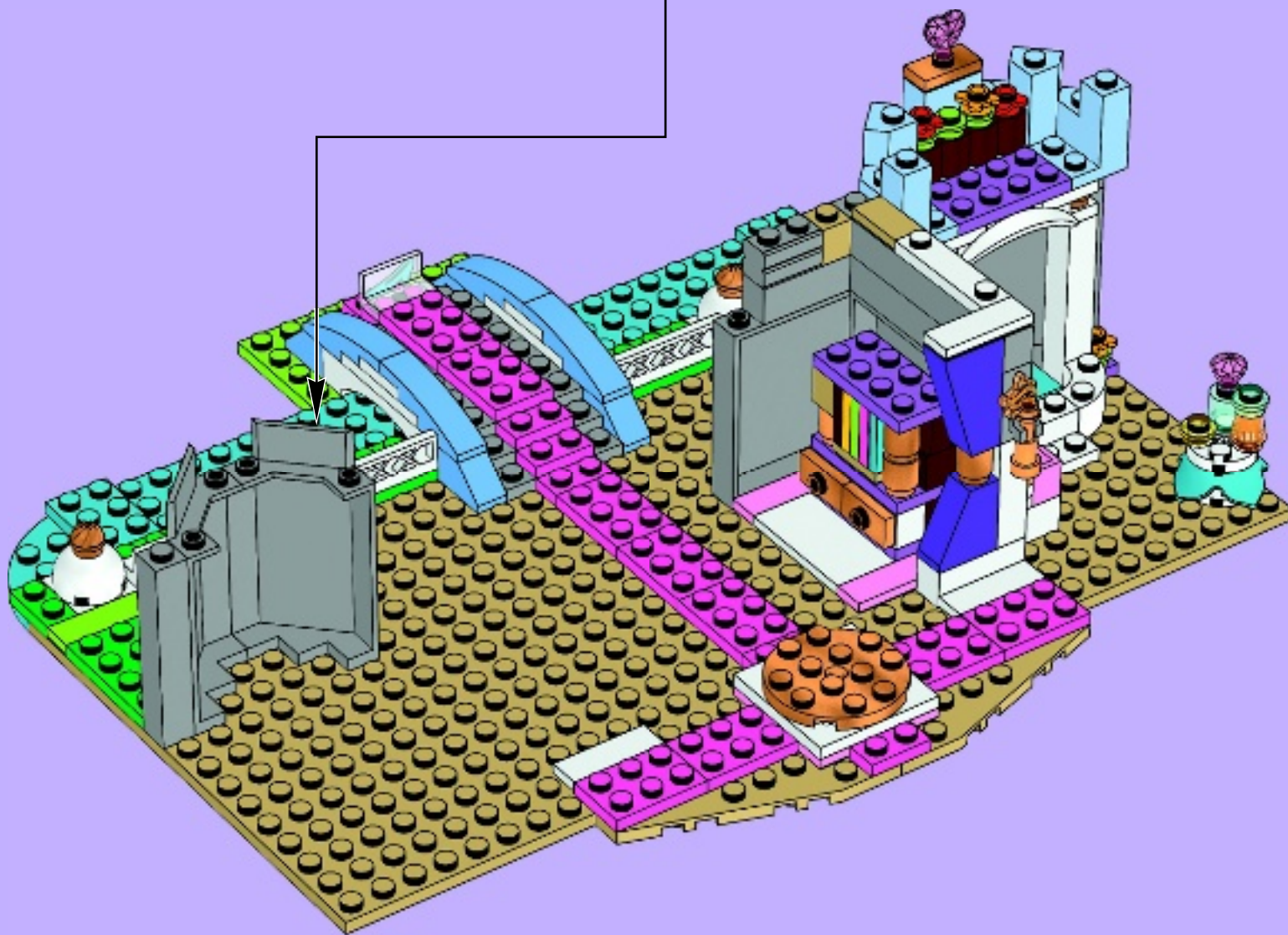
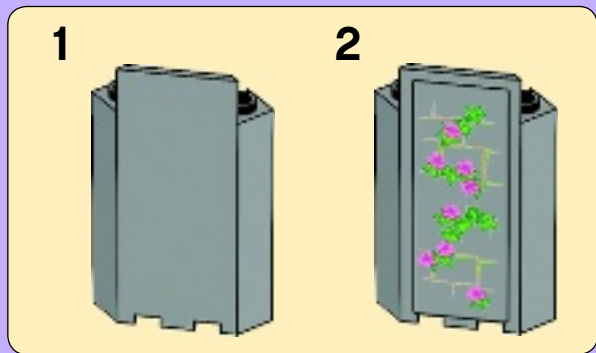

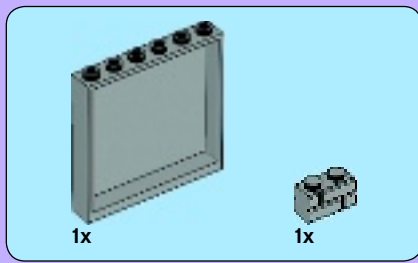

53



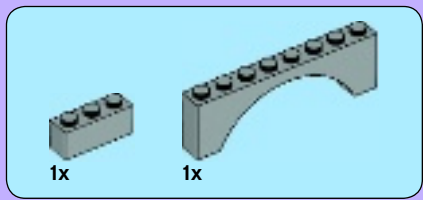

54

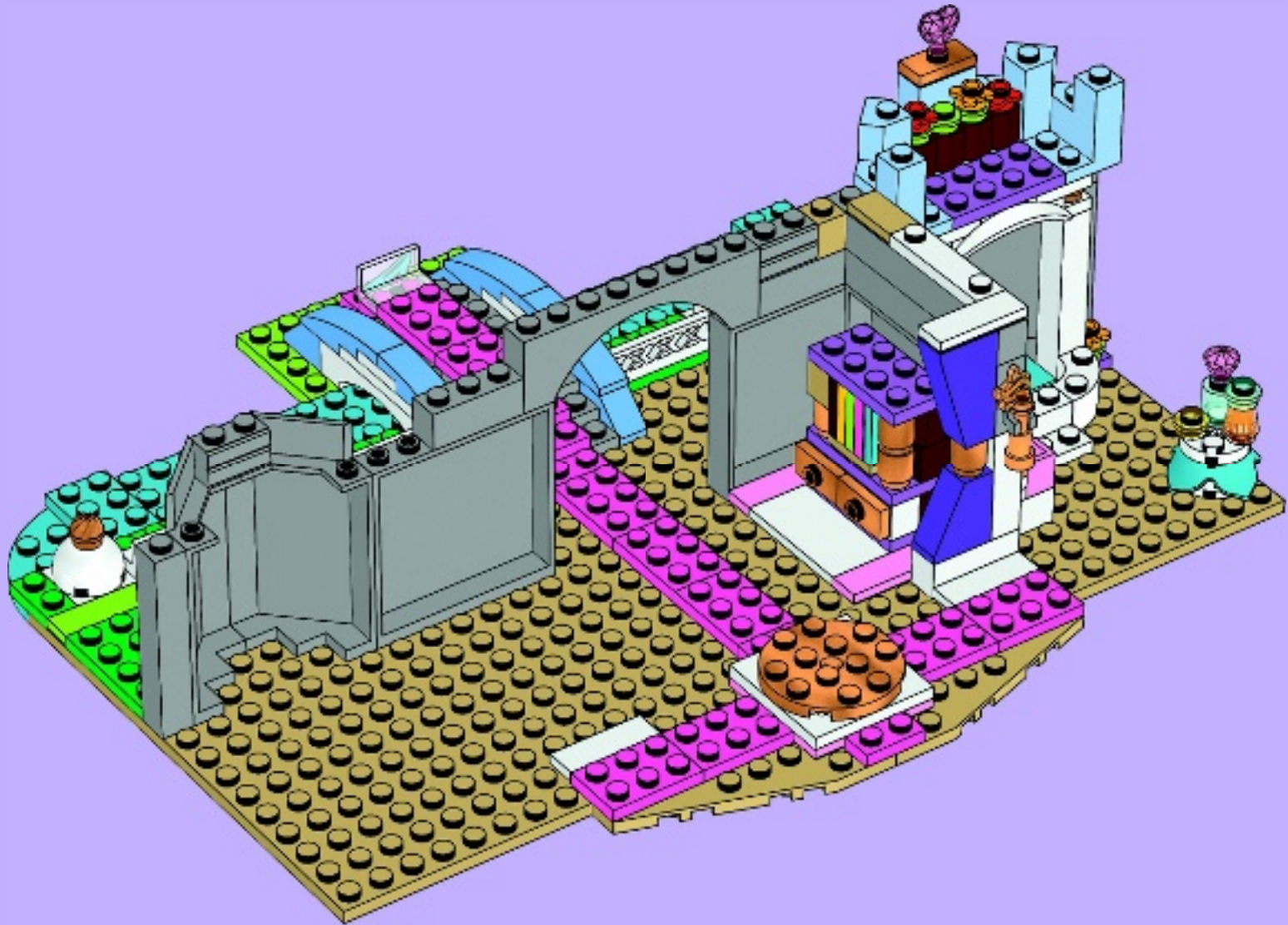

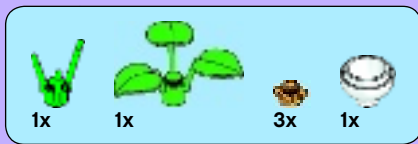

55



1



2



3

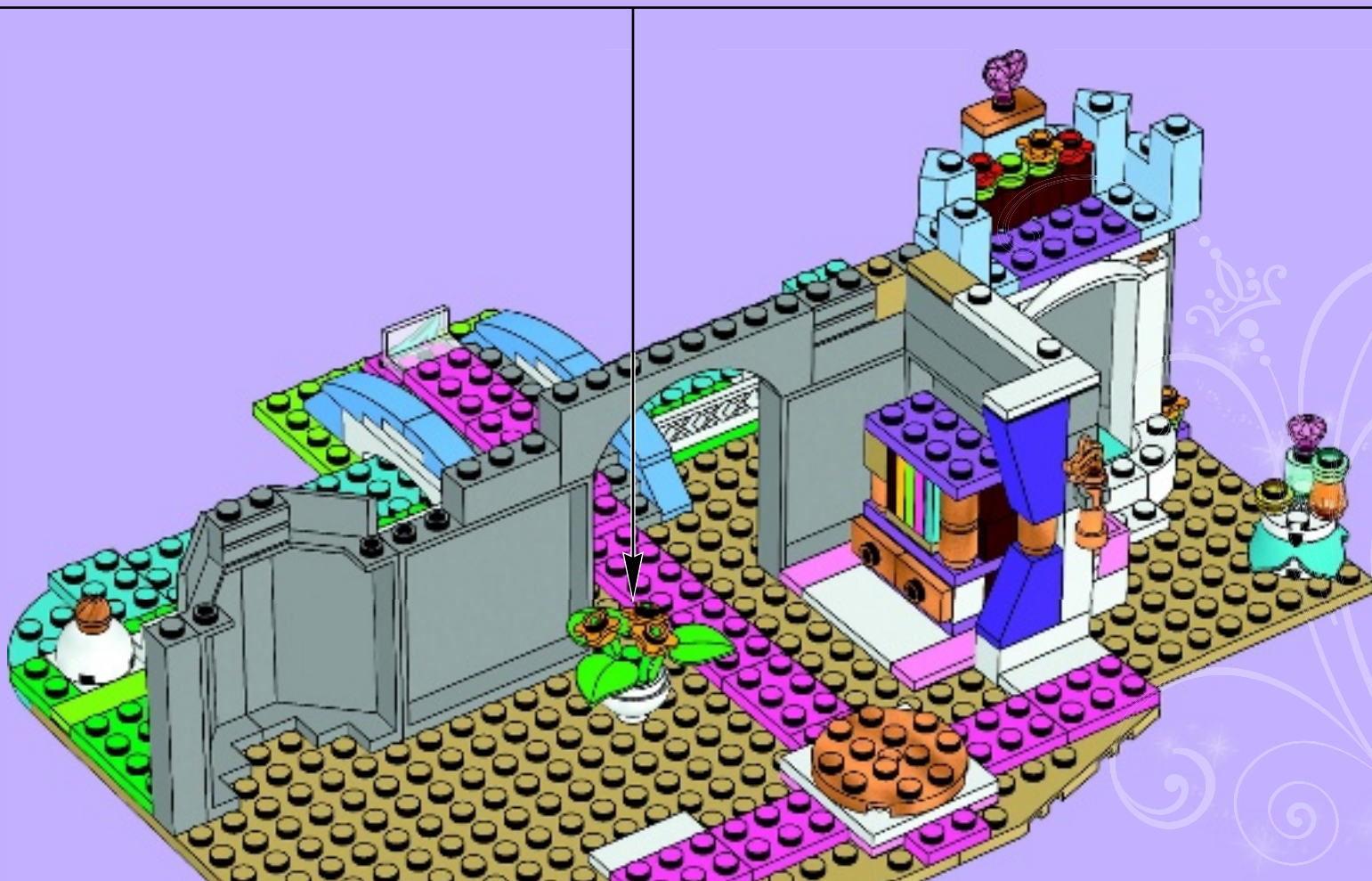

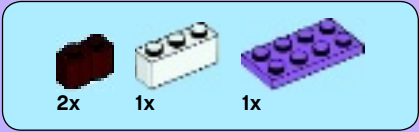

56

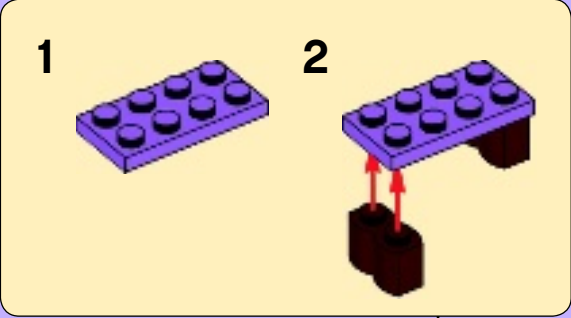

1x 4x 2x

57

2x





1x



1x



1x

58





59

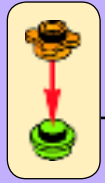

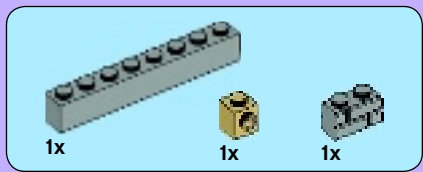

60

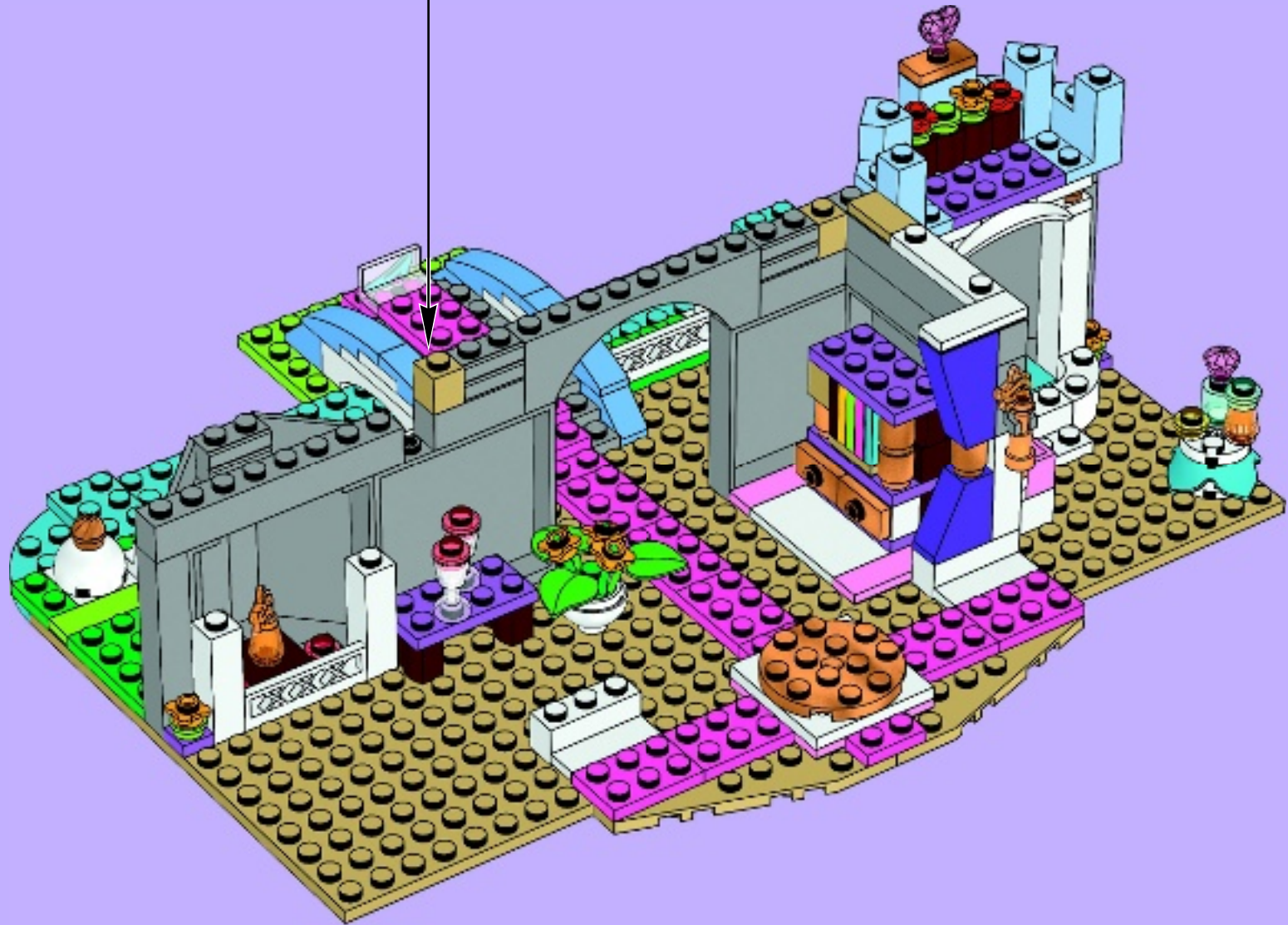

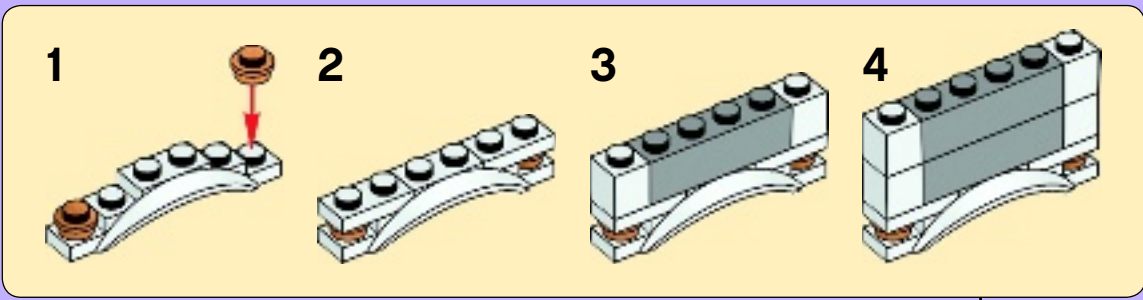
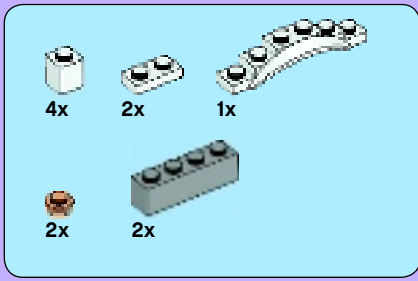

61

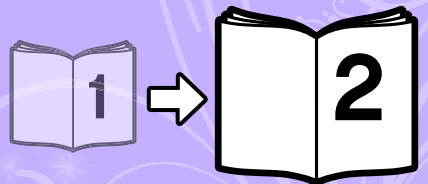

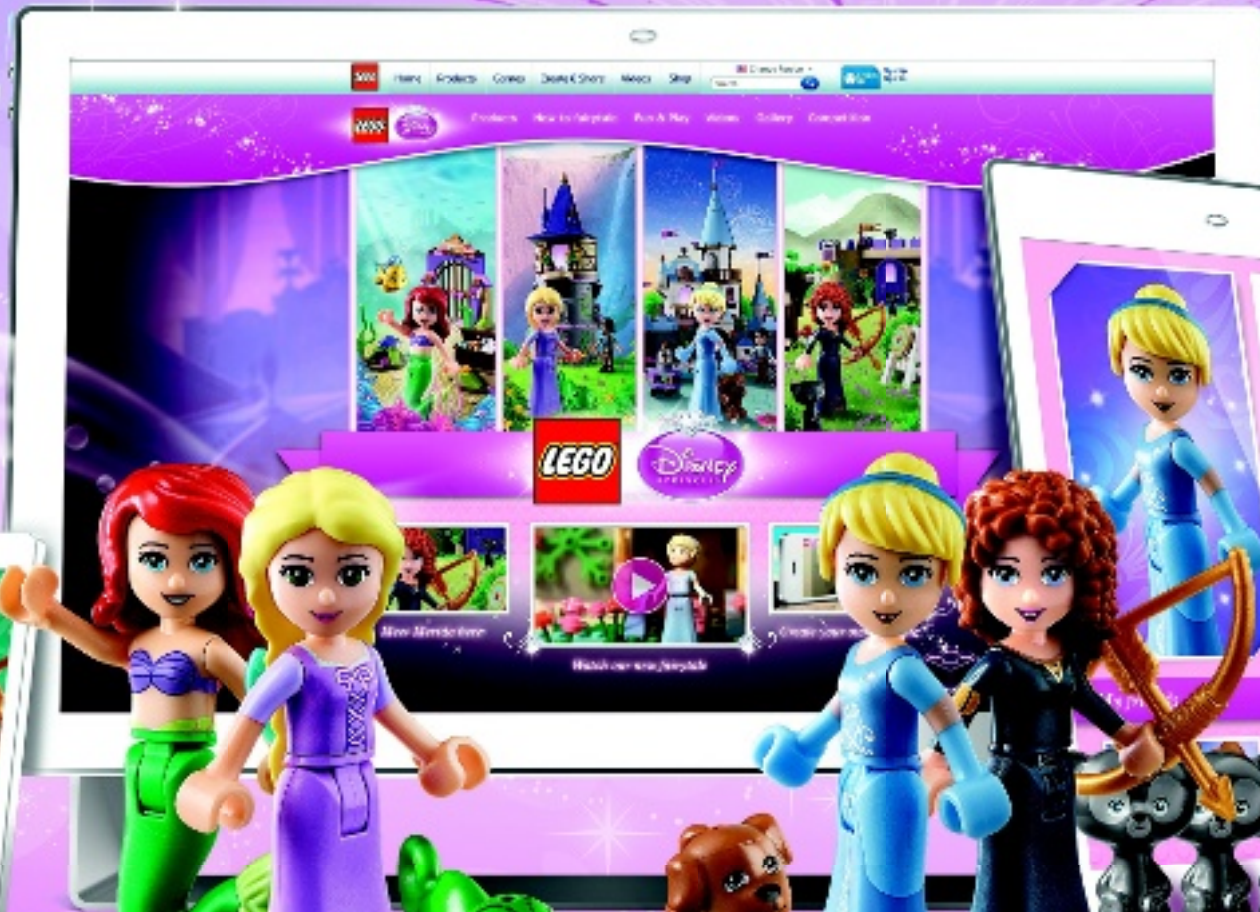
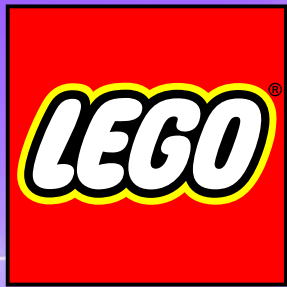

LEGO.com/disneyprincess