

**Croma Select S 1jet** 26805400  
**Croma Select E 1jet** 26815400

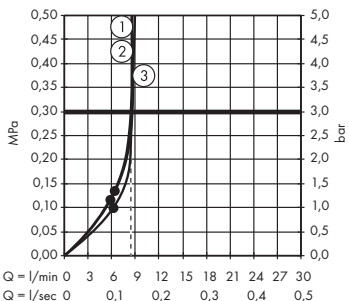

**Croma Select S Vario** 26803400  
**Croma Select E Vario** 26813400

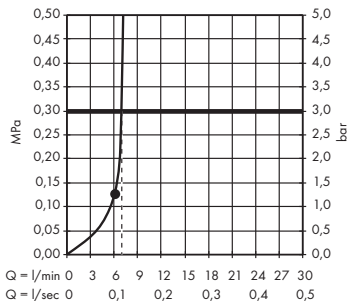

**Croma Select S 1jet** 26806400  
**Croma Select E 1jet** 26816400

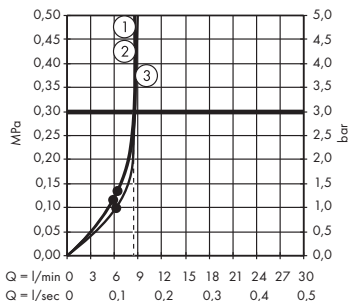

**Croma Select S Multi** 26801400  
**Croma Select E Multi** 26811400



**Croma Select S Vario** 26803400  
**Croma Select E Vario** 26813400  
**Croma Select S Multi** 26801400  
**Croma Select E Multi** 26811400

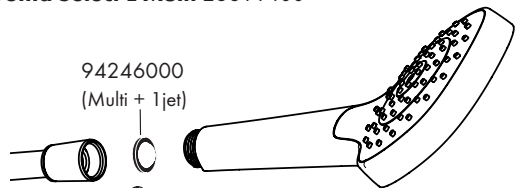
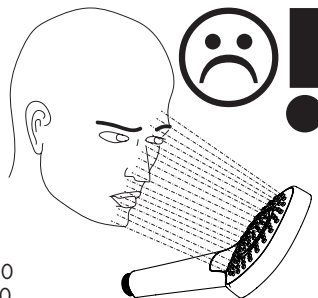

	P-IX	NF	DVGW
<b>26801400</b>	P-IX 28499/IB		
<b>26803400</b>	P-IX 28500/IB	X	
<b>26805400</b>	P-IX 28501/IB		
<b>26806400</b>	P-IX 28501/IB		
<b>26811400</b>	P-IX 28502/IB		
<b>26813400</b>	P-IX 28503/IB	X	
<b>26815400</b>	P-IX 28504/IB		
<b>26816400</b>	P-IX 28504/IB		

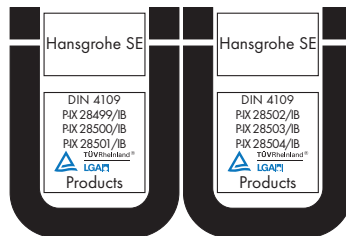

- DE** Montageanleitung
- FR** Instructions de montage
- EN** assembly instructions
- IT** Istruzioni per Installazione
- ES** Instrucciones de montaje
- NL** Handleiding
- DK** Monteringsvejledning
- PT** Manual de Instalação
- PL** Instrukcja montażu
- CS** Montážní návod
- SK** Montážny návod
- ZH** 组装说明
- RU** Инструкция по монтажу
- HU** Szerelési útmutató
- FI** Asennusohje
- SV** Monteringsanvisning
- LT** Montavimo instrukcijos
- HR** Uputstva za instalaciju
- TR** Montaj kılavuzu
- RO** Instrucțiuni de montare
- EL** Οδηγία συναρμολόγησης
- SL** Navodila za montažo
- ET** Paigaldusjuhend
- LV** Montāžas instrukcija
- SR** Uputstvo za montažu
- NO** Montasjeveiledning
- BG** Инструкция за употреба
- SQ** Udhëzime rreth montimit
- AR** تعليمات التجميع
- JP** 施工説明書

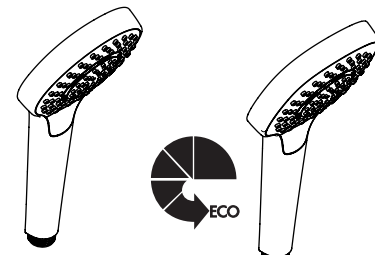

**Croma Select S Multi** 26801400  
**Croma Select S Vario** 26803400  
**Croma Select S 1jet** 26805400 / 26806400

**Croma Select E Multi** 26811400  
**Croma Select E Vario** 26813400  
**Croma Select E 1jet** 26815400 / 26816400

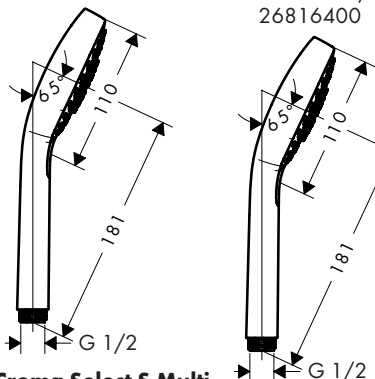

**Croma Select S Multi** 26801400  
**Croma Select S Vario** 26803400  
**Croma Select S 1jet** 26805400 / 26806400

**Croma Select E Multi** 26811400  
**Croma Select E Vario** 26813400  
**Croma Select E 1jet** 26815400 / 26816400

**DE** Reinigungsempfehlung / Garantie / Kontakt  
**FR** Recommandation pour le nettoyage / Garanties / Contact  
**EN** Cleaning recommendation / Warranty / Contact  
**IT** Raccomandazione di pulizia / Garanzia / Contatto  
**ES** Recomendaciones para la limpieza / Garantía / Contacto  
**NL** Aanbevelingen inzake reiniging / Garantie / Contact  
**DK** Rensning, anbefaling / Garanti / Kontakt  
**PT** Recomendações de limpeza / Garantia / Contacto  
**PL** Zalecenie dotyczący pielęgnacji / Gwarancja / Kontakt  
**CS** Doporučení k čištění / Záruka / Kontakt  
**SK** Odporúčania pre čistenie / Záruka / Kontakt  
**ZH** 清洁指南 / 担保 / 接触  
**RU** Рекомендации по очистке / Гарантия / Контакты  
**FI** Puhdistussuositus / Takuu / Kosketus  
**SV** Rengöringsrekommendationer / Garanti / Contacto  
**LT** Valymo rekomendacijos / Garantija / Kontaktai  
**HR** Preporuke za čišćenje / Garancija / Kontakt  
**TR** Temizleme önerisi / Garanti / Temas  
**RO** Recomandări pentru curățare / Garanție / Contact  
**EL** Σύσταση καθαρισμού / γγύηση / επαφή  
**SL** Priporočilo za čiščenje / Garancija / Kontakt  
**ET** Puhastussuovitused / Garantii / Kontakt  
**LV** Tīrīšanas ieteikumi / Garantija / Kontakti  
**SR** Preporuke za čišćenje / Garancija / Kontakt  
**NO** Anbefaling for rengjøring / Garanti / Kontakt  
**BG** Препоръка за почистване / Гаранция / Контакт  
**SQ** Këshilla rreth pastrimit / Garancia / Kontakt  
**KO** 세정시 권장사항 / 품질보증 / 접촉  
**AR** توصيات التنظيف / الضمان (الولايات المتحدة الأمريكية) / اتصال  
**HU** Tisztítási tanácsok / Garancia / érintkezés  
**JP** お手入れの方法 / 保証について / ご連絡先



www.hansgrohe.com/  
cleaning-recommendation

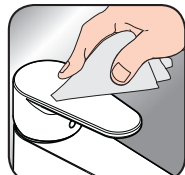

www.hansgrohe.com/  
cleaning-recommendation



www.hansgrohe.com/  
cleaning-recommendation



www.hansgrohe.com/  
cleaning-recommendation

## Service

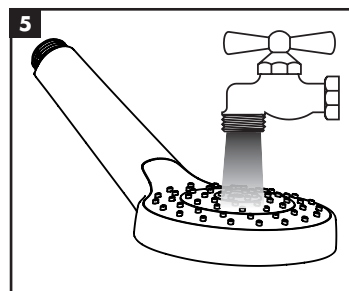
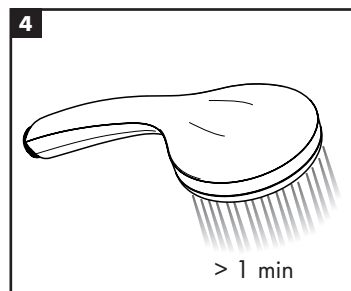
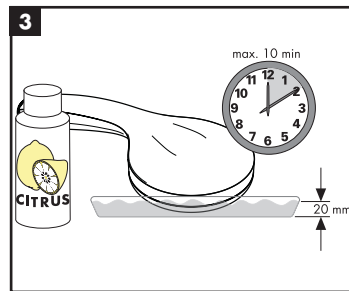
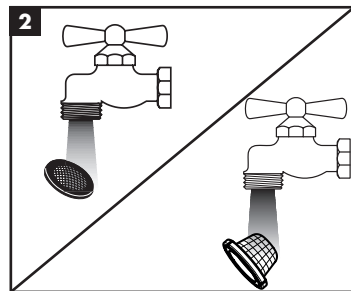
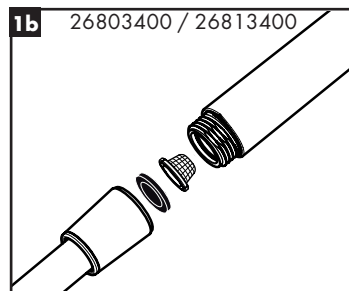
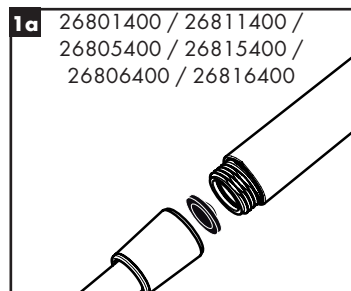

**DE** Einfach sauber: Kalk lässt sich von den Noppen ganz leicht abrubbeln.  
**FR** La propreté en toute simplicité: les dépôts formés sur les buses élastiques en silicone s'éliminent par un simple passage de la main.  
**EN** Just clean: simply rub over the spray nozzles to remove lime scale.  
**IT** Facile da pulire: Il calcare viene eliminato semplicemente dagli ugelli elastici in silicone.  
**ES** Fácil asear: La cal se puede retirar sencillamente frotando con los dedos de las toberas elásticas de silicona.  
**NL** Eenvoudig schoon: Kalk kan eenvoudig van de noppen worden gewreven.  
**DK** Enkel rengøring: Det er let at fjerne kalkaflejringer fra stråledyserne.  
**PT** Simplesmente limpo: o calcário pode ser simplesmente retirado das saliências através de fricção.  
**PL** Po prostu czysto: Pęczki można całkiem łatwo oczyścić z kamienia.  
**CS** Jednoduše čisté: Vapenné usazeniny můžete z noplek snadno odstranit ořením.  
**SK** Jednoducho čistý: Vodný kameň sa dá zo štetín celkom ľahko odstrániť.  
**ZH** 清洁: 只需要揉搓花洒表面的出水孔即可去除水垢。  
**RU** Простота чистки: известь очень легко стирается с утолщений.  
**FI** Yksinkertaisesti puhdas: kalkin voi helposti hieroa irti nypistä.  
**SV** Enkelt att göra rent: det är lätt att ta bort kalk från nopporna.  
**LT** Paprasta švara: kalkės lengvai nugaravamos nuo kilpos.  
**HR** Jednostavno čisto: Kamenac se savim lako uklanja s izbočina.  
**TR** Sadece temiz: Kireç, düğümlemlerle kolayca ovalanabilir.

**RO** Pur și simplu curat: Calcarul se îndepărtează ușor de pe noduri prin frecare.  
**EL** Απλά τέλεια καθαριότητα: Τα άλατα μπορούν να αφαιρεθούν με μεγάλη ευκολία από τα στόμια.  
**SL** Preprosto čisto: arnenec se z lahko odstrane z vozičkov.  
**ET** Lihtsalt puhas: lujja saab nupudelt lihtsalt maha hõõruda.  
**LV** Vienkārša tīrīšana: kaļķis no izvirzījumiem ir viegli norubināms.  
**SR** Jednostavno čisto: Kamenac se savim lako skida sa izbočina.  
**NO** Simpelten ren: Ved å gnikke er det lett å fjerne kalk fra nuppene.  
**BG** Просто чисто: Варовикът лесно може да се изтресе от удебеленията.  
**SQ** Thjesht dhe pastër. Mbetjet gëlqerore mund të hiqen me fërkim të lehtë.  
**AR** إنه سهل التنظيف، حيث يسقط الجير بسهولة شديدة من الأجزاء الفائقة.  
**HU** Egyszerűen tiszta: a vízkő egészen könnyen ledörzsölhető a csomókról.  
**JP** 清掃が簡単: カルキは突起部から簡単にこすり落とすことができます。

