

# User Guide



Lenovo Slim Pro 9i (16", 8)

## **Read this first**

Before using this documentation and the product it supports, ensure that you read and understand the following:

- [Generic Safety and Compliance Notices](#)
- *Safety and Warranty Guide*
- *Setup Guide*

**First Edition (March 2023)**

**© Copyright Lenovo 2023.**

LIMITED AND RESTRICTED RIGHTS NOTICE: If data or software is delivered pursuant to a General Services Administration "GSA" contract, use, reproduction, or disclosure is subject to restrictions set forth in Contract No. GS-35F-05925.

---

# Contents

<b>About this guide</b> . . . . .	<b>.iii</b>
-----------------------------------	-------------

<b>Chapter 1. Meet your computer</b> . . . . .	<b>1</b>
--	----------

Front . . . . .	1
Base . . . . .	2
Left . . . . .	3
Right . . . . .	4
Bottom . . . . .	5
Features and specifications . . . . .	6
Statement on USB transfer rate . . . . .	7
Operating environment . . . . .	7
Laser safety for the ToF sensor . . . . .	8
Avoid constant body contact with specific hot sections . . . . .	8

<b>Chapter 2. Get started with your computer</b> . . . . .	<b>9</b>
--	----------

Work with Windows . . . . .	9
Windows help information . . . . .	10
Lenovo Vantage and Lenovo PC Manager . . . . .	10
The Novo Button menu . . . . .	10
Open the Novo Button menu . . . . .	10
Interact with your computer . . . . .	11
Hotkeys . . . . .	11
Touch operations supported by Windows . . . . .	12

<b>Chapter 3. Explore your computer</b> . . . . .	<b>15</b>
---	-----------

Intelligent features . . . . .	15
Eye Care Mode . . . . .	15
Smart Key . . . . .	15
Gesture Controls (Touch screen/Touchpad) . . . . .	15
Presence Detection . . . . .	15
Super Resolution . . . . .	15
Smart Noise Cancelling . . . . .	15
Smart Appearance . . . . .	16
Manage power . . . . .	16
Rechargeable battery pack . . . . .	16
Normal mode . . . . .	16
Rapid charge mode . . . . .	16
Conservation mode . . . . .	16
Nighttime charge optimization . . . . .	17
Recover full battery capacity . . . . .	17
Set power button behavior . . . . .	17
A power plan . . . . .	17

System operation modes . . . . .	18
Adjustable display refresh rate . . . . .	18
Change settings in UEFI/BIOS setup utility . . . . .	19
What is UEFI/BIOS setup utility . . . . .	19
Open the UEFI/BIOS setup utility . . . . .	19
Select boot devices . . . . .	19
Change hotkey mode . . . . .	19
Enable or disable always-on . . . . .	19
Enable or disable Flip to Start . . . . .	20
Set passwords in UEFI/BIOS setup utility . . . . .	20
Password types . . . . .	20
Set administrator password . . . . .	20
Change or remove administrator password . . . . .	21
Set user password . . . . .	21
Enable power-on password . . . . .	21
Set hard disk password . . . . .	21
Change or remove hard disk password . . . . .	22

<b>Chapter 4. Help and support</b> . . . . .	<b>23</b>
--	-----------

Frequently asked questions . . . . .	23
How do I partition my storage drive . . . . .	23
What should I do if my computer stops responding . . . . .	23
What should I do if I spill liquid on the computer . . . . .	23
Where can I get the latest device drivers and UEFI/BIOS . . . . .	23
Why does my screen brightness change constantly . . . . .	23
Why does my computer start automatically when I open the lid . . . . .	23
Self-help resources . . . . .	24
What is a CRU? . . . . .	25
CRUs for your product model . . . . .	25
Call Lenovo . . . . .	25
Before you contact Lenovo . . . . .	25
Lenovo Customer Support Center . . . . .	26
Purchase additional services . . . . .	26

<b>Appendix A. Function descriptions for Lenovo hotkeys</b> . . . . .	<b>27</b>
---	-----------

<b>Appendix B. Notices and trademarks</b> . . . . .	<b>29</b>
---	-----------



---

## About this guide

- This guide applies to Lenovo product model(s) listed below. Illustrations in this guide may look slightly different from your product model.

Model name	Machine type (MT)
Lenovo Slim Pro 9 16IRP8	83C0

- For further compliance information, refer to the *Generic Safety and Compliance Notices* at [https://pcsupport.lenovo.com/docs/generic\\_notices](https://pcsupport.lenovo.com/docs/generic_notices).
- This guide may contain information about accessories, features, and software that are not available on all models.
- This guide contains instructions that are based on the Windows operating system. These instructions are not applicable if you install and use other operating systems.
- Microsoft® makes periodic feature changes to the Windows® operating system through Windows Update. As a result, the operating system related instructions may become outdated. Refer to Microsoft resources for the latest information.
- The content of the guide is subject to change without notice. To obtain the latest version, go to <https://support.lenovo.com>.



---

## Chapter 1. Meet your computer

---

### Front



Item	Controls & Connectors	Description
1	Microphones	Capture or record sound and voice.
2	Ambient light sensor (ALS)	Detect the ambient lighting and adjust the brightness of the screen and keyboard automatically. <b>Note:</b> To turn off the automatic brightness adjustment, type display settings in the Windows search box and then press Enter.
3	Infrared LED	Emit infrared light for face authentication.
4	Camera	<ul style="list-style-type: none"><li>• Capture still and moving images for taking photos, recording videos, and video chatting.</li><li>• Capture your face images for face authentication.</li></ul> <b>Note:</b> Use Windows Hello to enroll your face for face authentication.
5	Camera light	If the light is on, the camera is in use.
6	Time of flight (ToF) sensor	Detect human presence in front of the computer for facilitating zero touch and other convenient features. See “Laser safety for the ToF sensor” on page 8.
7	Screen	Display text, graphics, and videos. Selected models support multi-touch function.

## Base



Item	Controls & Connectors	Description
1	Wireless antennas	Send and receive radio waves for the built-in wireless LAN (local area network) and Bluetooth module. <b>Notes:</b> <ul style="list-style-type: none"><li>The antennas are not visible from the outside of the computer.</li><li>If the location of the antennas is close to the user's body (&lt; 20 cm), you can find the Specific Absorption Rate (SAR) values in the <i>Setup Guide</i> that comes with your computer.</li></ul>
2	Speakers	Produce sound.
3	Numeric keypad	To enable or disable the numeric keypad, press the Num Lock key.
4	Touchpad	Perform finger touch and all the functions of a traditional mouse. <b>Note:</b> The touchpad also supports multi-touch function.
5	Keyboard	Enter characters and interact with programs. <b>Note:</b> The keyboard also includes hotkeys and function keys for changing settings and performing tasks quickly.



## Left

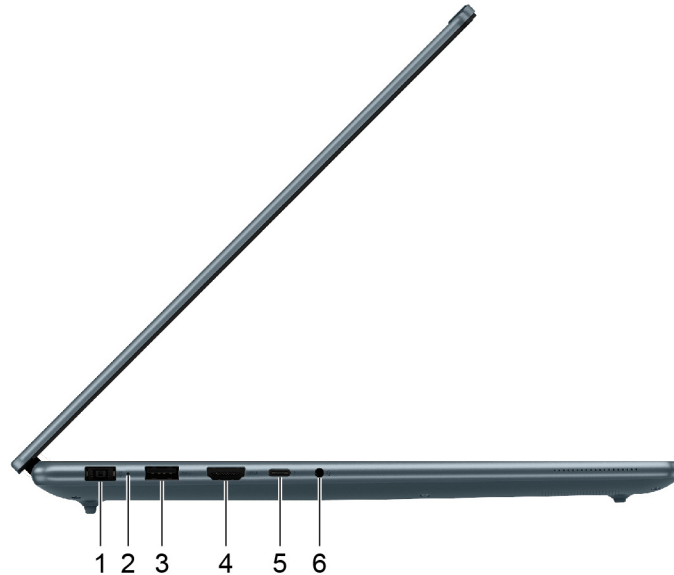

Item	Controls & Connectors	Description
1	Power connector	Connect to power with the included power cord and ac power adapter.
2	Charging light	Indicate whether the computer is connected to ac power. <ul style="list-style-type: none"><li>• Solid white: Connected to ac power; battery capacity 91%–100%</li><li>• Solid amber: Connected to ac power; battery capacity 1%–90%</li><li>• Off: Not connected to ac power</li></ul>
3	USB (3.2 Gen 1) Type-A connector	Connect to a USB-compatible device, such as a USB keyboard, a USB mouse, a USB storage device, or a USB printer.
4	HDMI™ connector	Connect to a compatible digital audio device or video monitor, such as an HDTV.
5	Multi-purpose USB Type-C® connector	This multi-purpose connector is Thunderbolt™ 4 enabled. When connected with a Thunderbolt enabled device, data transfer may be established in Thunderbolt mode. It can also be used to connect display devices and devices that utilize the USB data transfer technology. <b>Note:</b> When connecting display devices, you need to use appropriate cables and adapters (if needed) according to the connection capabilities of the display device.
6	Combo audio jack	Connect to headphones or headsets with a 3.5 mm (0.14 inch), 4-pole plug. <b>Note:</b> This jack does not support standalone external microphones. If you use headsets, choose one with a single plug.

## Right



Item	Controls & Connectors	Description
1	Camera switch	Turn the camera on or off.
2	Power light	Indicate the power and battery status of the computer. <ul style="list-style-type: none"><li>• On: The computer is turned on.</li><li>• Blinking fast: The computer is turned on; battery charge percentage 1% - 20%.</li><li>• Blinking slowly: The computer is in sleep mode.</li><li>• Off: The computer is turned off or in hibernation mode.</li></ul>
3	Power button	Press the button to turn on the computer or put the computer into sleep mode. <b>Note:</b> You can turn on the computer by flipping open the LCD screen if Flip to Start is enabled.
4	SD card slot	Insert an SD card or a MultiMediaCard (MMC) into the slot for data transfer or storage.
5	USB (3.2 Gen 1) Type-A connector	Connect to a USB-compatible device, such as a USB keyboard, a USB mouse, a USB storage device, or a USB printer.

## Bottom

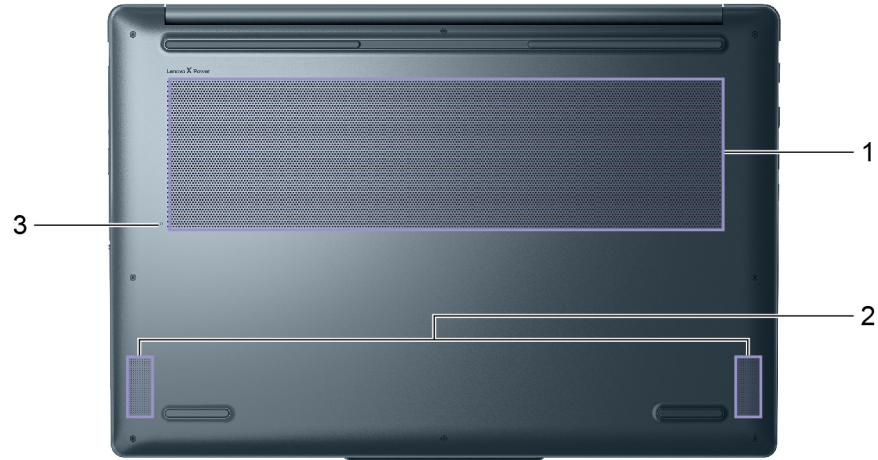

Item	Controls & Connectors	Description
1	Ventilation slots	Dissipate internal heat. <b>Note:</b> Do not block the ventilation slots. Otherwise, the computer might overheat.
2	Speakers	Produce sound.
3	Novo button hole	Press the Novo Button to open the <b>Novo Button</b> menu. From the menu, you can choose to open the UEFI/BIOS setup utility, the Boot menu, or the Windows startup options screen.

---

## Features and specifications

---

Specifications	Descriptions
Dimensions	<ul style="list-style-type: none"><li>• Width: 362.44 mm (14.3 inches)</li><li>• Depth: 258.93 mm (10.2 inches)</li><li>• Thickness: 19.99 mm (0.8 inches) or 21.69 mm (0.9 inches)</li></ul>
ac power adapter	<ul style="list-style-type: none"><li>• Input: 100 V ac–240 V ac, 50 Hz–60 Hz</li><li>• Output: 20 V dc, 6.75 A/20 V dc, 8.5 A/20 V dc, 11.5 A</li><li>• Power: 135 W/170 W/230 W</li></ul>
Battery pack	<ul style="list-style-type: none"><li>• Capacity: 75 Wh</li><li>• Number of cells: 4</li></ul> <p><b>Note:</b> The battery capacity is the typical or average capacity as measured in a specific test environment. Capacities measured in other environments may differ but are no lower than the rated capacity (see product label).</p>
Microprocessor	To view the microprocessor information of your computer, type system information in the Windows search box and then press Enter.
Memory	<ul style="list-style-type: none"><li>• Type: Low power double data rate 5X (LPDDR5X)</li><li>• Number of physical slots: 0</li></ul>
Storage device	<ul style="list-style-type: none"><li>• Type: solid-state drive</li><li>• Form factor: M.2 (2280)</li><li>• Bus: PCI Express</li></ul>
Screen	<ul style="list-style-type: none"><li>• Size: 406.4 mm (16 inches)</li><li>• Display resolution: 3200 × 2000 pixels</li></ul>
Keyboard	<ul style="list-style-type: none"><li>• Function keys</li><li>• Hotkeys</li><li>• Numeric keypad</li><li>• Keyboard backlight</li></ul>

---

Specifications	Descriptions
Connectors and slots	<ul style="list-style-type: none"> <li>• Power connector</li> <li>• Combo audio jack</li> <li>• USB Standard-A connector × 2 <ul style="list-style-type: none"> <li>– Supports data transfer rates up to 5 Gbps for USB 3.2 Gen 1</li> </ul> </li> <li>• Multi-purpose USB Type-C connector <ul style="list-style-type: none"> <li>– Supports maximum signaling rate of 41.25 Gbps in Thunderbolt mode</li> <li>– Supports SuperSpeed USB 10 Gbps</li> <li>– Supports DisplayPort Alt Mode (DisplayPort 1.4 compliant)</li> <li>– Supports power output up to 15 W (5 V, 3 A)</li> <li>– Supports USB Power Delivery</li> </ul> </li> <li>• HDMI connector <ul style="list-style-type: none"> <li>– Supports 4096 × 2160 @ 60 Hz as specified in HDMI 2.1</li> </ul> </li> <li>• SD card slot</li> </ul> <p><b>Note:</b> Data rates and performance ratings are dependent on connected devices and cables if they are used. USB Type-C connectors that are DisplayPort 1.4 compliant through DisplayPort alternate mode provide maximum output resolution of 5120 x 3200, at 60 Hz frame rate and color depth of 24 bpp (bits per pixel). For connections using a converter or an adapter, the actual output resolution may be lower.</p>
Security	<ul style="list-style-type: none"> <li>• UEFI/BIOS passwords <ul style="list-style-type: none"> <li>– Administrator password</li> <li>– User password</li> <li>– Master hard disk password</li> <li>– User hard disk password</li> </ul> </li> </ul>
Network	<ul style="list-style-type: none"> <li>• Bluetooth and Wi-Fi combo adapter</li> </ul>

## Statement on USB transfer rate

Depending on many factors such as the processing capability of the host and peripheral devices, file attributes, and other factors related to system configuration and operating environments, the actual transfer rate using the various USB connectors on this device will vary and will be slower than the data rate listed below for each corresponding device.

USB device	Data rate (Gbit/s)
3.2 Gen 1	5
3.2 Gen 2	10

## Operating environment

### Maximum altitude (without pressurization)

3048 m (10 000 ft)

### Temperature

- At altitudes up to 2438 m (8000 ft)

- Operating: 5°C to 35°C (41°F to 95°F)
- Storage: 5°C to 43°C (41°F to 109°F)
- At altitudes above 2438 m (8000 ft)
  - Maximum temperature when operating under the unpressurized condition: 31.3°C (88°F)

**Note:** When you charge the battery, its temperature must be no lower than 10°C (50°F).

#### **Relative humidity**

- Operating: 8% to 95% at wet-bulb temperature 23°C (73°F)
- Storage: 5% to 95% at wet-bulb temperature 27°C (81°F)

### **Laser safety for the ToF sensor**



This device is classified as a Class 1 laser product per *EN/IEC 60825-1:2014*. This device complies with FDA performance standards for laser products except for conformance with *IEC 60825-1 Ed. 3*, as described in *Laser Notice No. 56*, dated May 8, 2019.

#### **CAUTION:**

**This device contains a laser that could be damaged during repair or disassembly, which could result in hazardous exposure to infrared laser emissions. There are no user serviceable parts with the device. Do not attempt to disassemble or service the device.**

### **Avoid constant body contact with specific hot sections**

#### **CAUTION:**

**When the computer is operating, it should be placed on a hard and flat surface with its bottom area not in contact with user's bare skin. Under normal operating conditions, the temperature of the bottom surface will remain within an acceptable range as defined in *IEC 62368-1*, but such temperatures can still be high enough to cause discomfort or harm to the user if directly touched for over one minute at a time. As such, it is recommended that users avoid prolonged direct contact with the bottom of the computer.**

---

## Chapter 2. Get started with your computer

---

### Work with Windows

The following table contains Windows frequently used settings. You can learn the basics and start working with Windows right away.

To configure settings, type the corresponding keywords in the Windows search box and select the best match. Follow the on-screen instructions to customize settings.

Table 1. Basic settings

Functions	Descriptions	Search by keywords
Control Panel	View or change Windows settings, including hardware and software setup and configuration.	Control Panel
Connect to Wi-Fi networks	For models with a wireless LAN module, you can connect your computer to a Wi-Fi® network. Click the network icon in the Windows notification area, and then select a network for connection. <b>Note:</b> The wireless LAN module on your computer may support different standards. For some countries or regions, use of 802.11ax may be disabled according to local regulations.	Wi-Fi
Airplane mode	Airplane mode is a convenient setting to turn all wireless communications of your computer on and off. You may need to turn it on when boarding an airplane.	Airplane mode
Night light mode	Night light is a switch in Windows that you can turn on and off. When it is turned on, your screen shows warmer colors and the amount of emitted blue light is reduced. Enabling night light reduces the chances of developing eye fatigue or eye strain. <b>Note:</b> For more guidance on reducing eye fatigue or eye strain, go to <a href="https://www.lenovo.com/us/en/compliance/visual-fatigue">https://www.lenovo.com/us/en/compliance/visual-fatigue</a> .	Night light
Adjust color temperature	If night light mode is turned on, you can adjust the color temperature of the screen. <b>Note:</b> Selected Lenovo computers are low blue light certified using night light mode and color temperature settings available in the pre-installed operating system. These computers are tested with night light turned on and color temperature set to 48 or greater.	Night light
Windows Updates	Microsoft periodically releases feature and security updates to the Windows operating system. Updates that are applicable to your Windows version are downloaded automatically when your computer is connected to the Internet. When updates are downloaded, you are prompted to restart the computer to install these updates. You can also manually check if there are available updates for the installed version of Windows. <b>Attention:</b> Only use Windows Update to download and install updates. Updates downloaded from other sources may include security risks.	Windows Updates

Table 2. Optional settings

Functions	Descriptions	Search by keywords
Set up face recognition	For models with a Windows Hello-compatible infrared camera, you can set up face recognition to sign in with your face.	Sign-in options

## Windows help information

If the on-screen instructions cannot solve your problem, refer to the following to get the online Windows help information.

- Type Get Help or Tips in the Windows search box and then press Enter. When the app opens, type the problem description and select the matched result.
- Visit Microsoft support Web site: <https://support.microsoft.com>. Enter what you are looking for in the search box and get search results.

---

## Lenovo Vantage and Lenovo PC Manager

They are both apps developed by Lenovo. Using either of them, you can:

- View product information and system status
- Manage and change device settings
- Check for and perform system update

**Note:** This feature is only available on Lenovo Vantage. In Lenovo PC Manager, you can check for and perform driver update.

Depending on the country or region in which your computer is purchased, one of the apps may be pre-installed on your computer. To open it, type its name in the Windows Search box and select the matched result. If neither of the apps is pre-installed, you may install one on your own. Lenovo Vantage is available for download free of charge from the Microsoft Store.

**Note:** App features are subject to change with updates and specific features may not be available on all Lenovo products.

---

## The Novo Button menu

The Novo Button menu can be displayed before the operating system starts. From the menu, you can choose to

- Open the BIOS/UEFI setup utility
- Open the boot device selection menu
- Open the Windows startup options screen

**Note:** From the Windows startup options screen, you can then choose to

- Start your computer using a recovery drive
- Reset your computer
- Open advanced options screen

## Open the Novo Button menu

For Lenovo computers with a Novo button, you can press the button to open the Novo Button menu.

Step 1. Turn off the computer.

Step 2. Open the LCD screen and press the Novo button.

**Note:** Alternatively, turn off the computer. Press Fn and the power button to open the Novo Button menu.



---

## Interact with your computer

### Hotkeys

Look at the top row of the keyboard of your Lenovo computer and you'll find keys with printed icons. These keys are called hotkeys and they provide shortcuts to functions that you'll use frequently. The function that each hotkey provides is denoted by the icon printed on the key.

Hotkeys share keys with function keys (F1–F12) and other keys. Depending on the FnLock setting, you use hotkey functions by pressing the key directly or in combination with the Fn key.

**Note:** The FnLock switch does not apply to hotkeys not found in the first row of the keyboard. To use these hotkeys, always hold down the Fn key while pressing the key.

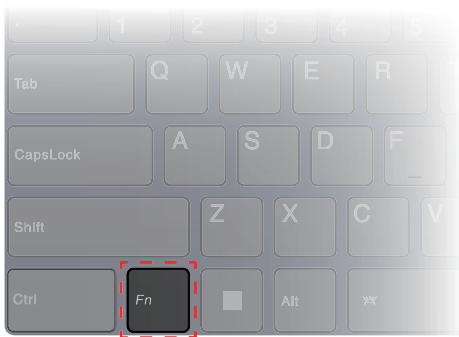

Figure 1. Location of the Fn key

### Related topics

Appendix A “Function descriptions for Lenovo hotkeys” on page 27

### The FnLock switch

The FnLock is an electronic switch that affects how you use hotkey functions. To turn it on and off, press Fn + Esc.

**Note:** The Esc key is in the upper left corner of the keyboard. It has an LED that indicates the status of the FnLock switch.

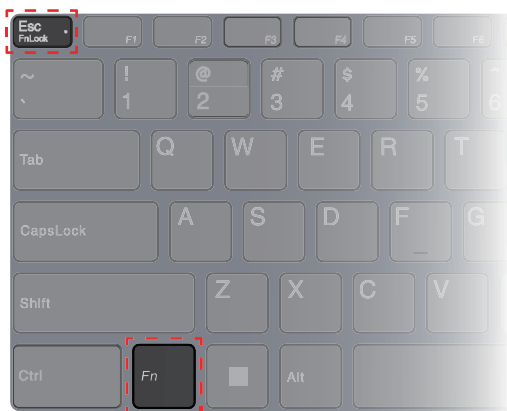

Figure 2. Locations of the FnLock key and the Fn key

A Lenovo keyboard usually contains hotkeys in the top row. These hotkeys share keys with the function keys (F1–F12) and other keys. For these dual-function keys, the icons or characters denoting the primary functions are printed on top of the icons and characters denoting the secondary functions.

- A: an icon or character denoting the primary function
- B: an icon or character denoting the secondary function

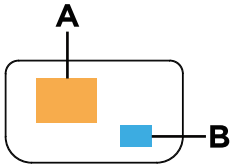

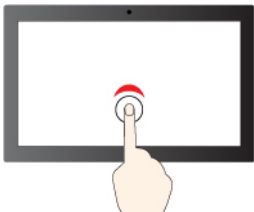

Figure 3. The layout of a dual-function key

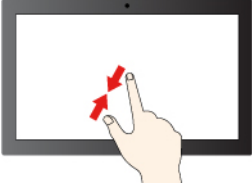
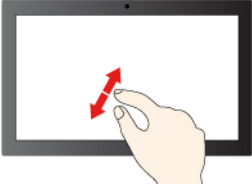
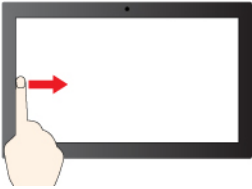

Table 3. **FnLock** and dual-function keys

FnLock (Esc) LED	FnLock status	Pressing the hotkey alone	Pressing the hotkey while holding down the Fn key
Off	Disabled	Primary function	Secondary function
On	Enabled	Secondary function	Primary function

## Touch operations supported by Windows

For computers with a touch-enabled screen, you can touch the screen directly with your fingers and interact with your computer in a more natural way. The following table lists frequently used touch operations that are supported by the Windows operating system.

Touch operation	Used for
 <p>Tap</p>	Opening apps, documents, and other functions on the taskbar or the Start menu
 <p>Tap twice quickly</p>	Opening apps that are pinned on the desktop

Touch operation	Used for
 <p data-bbox="415 426 596 453">Tap, hold and lift</p>	Opening the context menu
 <p data-bbox="475 667 537 695">Pinch</p>	Zooming out
 <p data-bbox="467 905 545 932">Spread</p>	Zooming in
 <p data-bbox="363 1150 647 1178">Swipe in from the left edge</p>	Opening the widgets panel
 <p data-bbox="358 1367 654 1394">Swipe in from the right edge</p>	Opening the notification center

The Windows operating system also supports 3- and 4-finger gestures on the screen and the touchpad. You can set them up in **Settings → Bluetooth & devices**.



---

## Chapter 3. Explore your computer

---

### Intelligent features

Your computer may be pre-installed with one of Lenovo Vantage, Lenovo PC Manager, or Lenovo Smart Engine but not all. Most features described here can be enabled or disabled in one of these apps. Other features may be enabled in a standalone app.

#### Notes:

- Software features are subject to change. Please refer to your actual product.
- You may need to complete online update to the apps for the features to take effect.

### Eye Care Mode

Eye Care Mode intelligently adjusts the color temperature of the screen and can reduce the chances of developing eye fatigue or eye strain.

### Smart Key

Smart Key  provides a quick shortcut to Lenovo apps and service. Press Smart Key to open the launch panel.

**Note:** There is also a trick to Smart Key. Go to **Preference** on the launch panel, select **ADD** and choose your favorite app to associate with Smart Key. When it is done, press Smart Key twice in quick succession and your favorite app is opened.

### Gesture Controls (Touch screen/Touchpad)

When watching videos in full screen mode, you can conveniently control the volume and adjust the screen brightness through intuitive gestures on the touch screen or touchpad.

**Note:** This feature does not support all video players and may conflict with similar third-party gesture functions.

### Presence Detection

Presence Detection enables you to improve work efficiency by automatically waking up and logging into your computer, or dimming the display and locking the computer depending on user detection. For selected video players, this feature will pause any video playing when you leave the computer and resume upon your return.

### Super Resolution

By utilizing the capabilities and potentials of Intel processors, Super Resolution helps you play videos with a higher resolution than the original. It works especially well in cases where the source video has a poor resolution.

For most players, Super Resolution can be enabled or disabled in Lenovo Vantage, Lenovo PC Manager, or Lenovo Smart Engine, but for some specific players, you might need to enable this feature manually.

### Smart Noise Cancelling

By filtering the input and output environments, Smart Noise Cancelling helps you reduce noise and optimize the call effect in different scenarios.

## Smart Appearance

Smart Appearance helps you blur the background behind you or replace the background with a variety of default and custom choices. You can also beautify the skin and refine your face shape to a preferred level. This setting could be applied to any video communication software you use on this computer.

---

## Manage power

Use the information in this section to achieve the best balance between performance and power efficiency.

### Rechargeable battery pack

Your computer includes a built-in, rechargeable battery pack that makes mobile computing a reality. When the computer is plugged into an electrical outlet, the battery charges. If you use the computer when you don't have access to an electrical outlet, the battery discharges to supply electricity that the computer system requires for operation.

You can charge the battery any time you want. The battery packs of Lenovo computers support multiple charging modes that are suitable for different power usage habits. You can switch the battery's active charging mode in Lenovo Vantage, Lenovo PC Manager, or Lenovo Smart Engine.

Battery charging is also affected by its temperature. The recommended temperature range for charging the battery is between 10°C (50°F) and 35°C (95°F).

#### Note:

You can check the battery temperature in Lenovo Vantage.

To maximize the life of the battery, once the battery is fully charged, it must discharge to 94% or lower before it will be allowed to recharge again.

### Normal mode

Normal mode is the most basic charging mode. In normal mode, it typically takes 2 to 4 hours for the battery to charge from 0% to 100%.

### Rapid charge mode

If you want the battery to be charged faster than in normal mode, switch the battery charging to rapid charge mode. The following table lists the estimated time needed for batteries in rapid charge mode to be charged to 80% and 100% respectively.

Table 4. Estimated charge time for batteries in rapid charge mode

Mode	Time needed to charge from 0% to 80%	Time needed to charge from 0% to 100%
Rapid charge	Less than 1 hour	Less than 2 hours

**Note:** The estimated charge time assumes that the battery is charged while the PC is in sleep, hibernation, or powered-off state.

### Conservation mode

If your computer is constantly plugged into an electrical outlet, consider switching the battery charging to conservation mode. In conservation mode, the battery will not be fully charged. Instead, the battery's charge will be kept within 75%–80%. This is beneficial to the long-term health of the battery.

**Note:** If you want the battery to be fully charged before bringing the computer to work, disable conservation mode by switching the battery charging to normal or rapid charge mode.

## Nighttime charge optimization

Some people follow a regular pattern when using their computers. They finish their workday with the computer at a low battery charge level. They plug in their computers at night and need the battery to be fully charged the next morning so they can unplug the computer and bring it to work. These activities happen at approximately the same time each day. If this sounds like you, consider enabling nighttime charge optimization for the battery.

Nighttime charge optimization affects battery charging during the night hours, the time when you're usually asleep. When it is enabled, the computer regularly adapts its charging behavior based on observation of when you plug in the computer at night and unplug it in the morning. During the nighttime, the battery is charged to a particular range and is kept within that range for an extended period, before being further charged to 100%. Nighttime charge optimization ensures safe charging during the night and is beneficial to the long-term health of the battery.

**Note:** With nighttime charge optimization enabled, if you break your routine one day by unplugging the computer much earlier than usual in the morning, you may find that the battery is not fully charged.

If the battery pack of your computer supports nighttime charge optimization, it can be enabled in Lenovo Vantage, Lenovo PC Manager, or Lenovo Smart Engine.

## Recover full battery capacity

If your computer is constantly plugged in to an electrical outlet and the battery rarely discharges, the battery may not be charged to its full capacity even if the battery meter reports 100% charge. You can recover the battery's full charging potential simply by discharging and re-charging the battery.

Step 1. Unplug the computer and use it until the battery charge drops below 20%.

Step 2. Plug in the computer and charge the battery to 100%.

## Set power button behavior

By default, pressing the power button puts the computer to sleep mode. However, you can change the power button behavior in Windows Control Panel.

Step 1. Type Control Panel in the Windows search box and then press Enter. Open the control panel and view by large or small icons.

Step 2. Select the power options and then click choose what the power button does.

## A power plan

A power plan is a collection of power-saving settings made available by an operating system. With a power plan, you can set idle time-outs for different hardware components to enter a low-power state. The default power plan and some of its idle time-out settings are listed below for computer models pre-installed with Windows.

The listed settings are active when the computer is connected to an electrical outlet. If your computer include a built-in battery pack, a different collection of time-out settings is set to take effect when the computer is operating on battery power.

- Default power plan: Balanced
- Turn off the display: after 5 minutes

- Put the computer to sleep: after 5 minutes

**Note:** To wake the computer from the sleep state, press the power button or any key on the keyboard.

## Change or customize a power plan

This operation is applicable to computers with pre-installed Windows.

Step 1. Type power plan in the Windows search box and then press Enter.

Step 2. Customize a power plan of your preference.

## System operation modes

Lenovo has preset several modes in which your computer can operate. The maximum attainable performance, power consumption, and speed limit for the heat sink fan vary between the operation modes. Consider the following conditions when you want to switch operation modes.

- The environment where you use your computer, and
- The tasks running on your computer

You can switch the operation mode in the pre-installed app Lenovo Vantage, Lenovo Smart Engine, or Lenovo PC Manager. As a shortcut, you can also use the key combination Fn + Q. Three modes are usually available for most Lenovo computers. The following table lists the operation modes and the recommended conditions for each mode.

**Note:** The operation modes listed in the table are descriptive and may not be the same as those displayed by the app.

Table 5. Operation modes and their recommended usage conditions

Operation mode	Recommended conditions
High Performance	<ul style="list-style-type: none"> <li>• Your computer is plugged into an electrical outlet.</li> <li>• You want the best performance, and</li> <li>• You don't care if the fan makes a little noise.</li> </ul>
Auto (Balance)	You plan to frequently switch between different computer tasks over a period time.
Power Saving (Quiet)	<ul style="list-style-type: none"> <li>• Your computer is operating on battery power, or</li> <li>• You want the computer to be as quiet as possible.</li> </ul>

**Note:** In Auto (Balanced) mode, the computer dynamically switches between High Performance mode and Power Saving (Quiet) mode depending on the tasks running on the computer.

## Adjustable display refresh rate

Your eyes might not notice it but the content displayed on the computer screen refreshes constantly. Display refresh rate refers to the number of times per second the screen content refreshes itself and is measured in hertz (Hz).

A refresh rate of 60 Hz is adequate for most situations and is energy efficient. However, when viewing videos or playing video games, a higher refresh rate usually provides a smoother viewing experience.

The displays of some Lenovo computers support dual refresh rates. For such a computer, you can manually switch its display to work at either the higher or lower refresh rate. For Windows operation systems, the



manual settings are usually found in **Settings → System → Display**. As a shortcut, you can also use the key combination Fn + R to switch the display refresh rate.

**Note:** Not all displays support dual refresh rates. If you cannot find settings to change the display refresh rate, the refresh rate of the display might be fixed or cannot be manually changed.

---

## Change settings in UEFI/BIOS setup utility

This section introduces what is UEFI/BIOS and the operations you can perform in its setup utility.

### What is UEFI/BIOS setup utility

UEFI/BIOS is the first program that runs when a computer starts. UEFI/BIOS initializes hardware components and loads the operating system and other programs. Your computer may include a setup program (setup utility) with which you can change certain UEFI/BIOS settings.

### Open the UEFI/BIOS setup utility

- Step 1. Turn on or restart the computer.
- Step 2. When the Lenovo logo appears on the screen, press F2 repeatedly.

**Note:** For computers with hotkey mode enabled, press Fn + F2.

### Select boot devices

Normally, the computer starts to a boot manager loaded from the secondary storage device of the computer. Occasionally, you may need to start the computer to a program or boot manager loaded from another device or a network location. After the system firmware initializes all devices, you can press an interruption key to display the boot menu and select a desired boot device.

- Step 1. Turn on or restart the computer.
- Step 2. Press F12.
- Step 3. From the boot device menu, select a boot device to start the computer.

You can make a permanent change on boot devices in the UEFI/BIOS setup utility. Select the **Boot** menu; in the **EFI** section, select the desired boot device and move it to the top of the device list. Save changes and exit the setup utility for the change to take effect.

### Change hotkey mode

- Step 1. Open the UEFI/BIOS setup utility.
- Step 2. Select **Configuration → Hotkey Mode** and press Enter.
- Step 3. Change the setting to **Disabled** or **Enabled**.
- Step 4. Select **Exit → Exit Saving Changes**.

### Enable or disable always-on

For some Lenovo computers with always-on connectors, the always-on function can be enabled or disabled in the UEFI/BIOS setup utility.

- Step 1. Open the UEFI/BIOS setup utility.
- Step 2. Select **Configuration → Always On USB** and press Enter.
- Step 3. Change the setting to **Disabled** or **Enabled**.

Step 4. Select **Exit** → **Exit Saving Changes**.

## Enable or disable Flip to Start

When Flip to Start is enabled, you can turn on the computer by flipping open the screen.

Step 1. Open the UEFI/BIOS setup utility.

Step 2. Select **Configuration**.

Step 3. Change the setting for **Flip to Start**.

**Note:** You may also set Flip to Start in Lenovo Vantage or Lenovo Smart Engine.

---

## Set passwords in UEFI/BIOS setup utility

This section introduces the types of passwords that you can set in the UEFI (Unified Extensible Firmware Interface) or BIOS (Basic Input/Output System) setup utility.

### Password types

You can set various types of passwords in the UEFI/BIOS setup utility.

Password type	Pre-requisite	Usage
Administrator password	No	You must enter it to start the setup utility.
User password	The administrator password must be set.	You can use the user password to start the setup utility.
Master hard disk password	No	You must enter it to start the operating system.
User hard disk password	The master hard disk password must be set.	You can use the user hard disk password to start the operating system.

#### Notes:

- All passwords set in the setup utility consist of alphanumeric characters only.
- If you start the setup utility using the user password, you can only change a few settings.

## Set administrator password

You set the administrator password to prevent unauthorized access to the UEFI/BIOS setup utility.

**Attention:** If you forget the administrator password, a Lenovo authorized service personnel cannot reset your password. You must take your computer to a Lenovo authorized service personnel to have the system board replaced. Proof of purchase is required and a fee will be charged for parts and service.

Step 1. Open the UEFI/BIOS setup utility.

Step 2. Select **Security** → **Set Administrator Password** and press Enter.

Step 3. Enter a password string that contains only letters and numbers and then press Enter

Step 4. Enter the password again and press Enter.

Step 5. Select **Exit** → **Exit Saving Changes**.

Next time you start the computer, you must enter the administrator password to open the setup utility. If **Power on Password** is enabled, you must enter the administrator password or the user password to start the computer.

## Change or remove administrator password

Only the administrator can change or remove the administrator password.

- Step 1. Open the UEFI/BIOS setup utility using the administrator password.
- Step 2. Select **Security → Set Administrator Password** and press Enter.
- Step 3. Enter the current password.
- Step 4. In the **Enter New Password** text box, enter the new password.
- Step 5. In the **Confirm New Password** text box, enter the new password again.

**Note:** If you want to remove the password, press Enter in both text boxes without entering any character.

- Step 6. Select **Exit → Exit Saving Changes**.

If you remove the administrator password, the user password is also removed.

## Set user password

You must set the administrator password before you can set the user password.

The administrator of the setup utility might need to set a user password for use by others.

- Step 1. Open the UEFI/BIOS setup utility using the administrator password.
- Step 2. Select **Security → Set User Password** and press Enter.
- Step 3. Enter a password string that contains only letters and numbers and then press Enter. The user password must be different from the administrator password.
- Step 4. Enter the password again and press Enter.
- Step 5. Select **Exit → Exit Saving Changes**.

## Enable power-on password

If the administrator password has been set, you can enable power-on password to enforce greater security.

- Step 1. Open the UEFI/BIOS setup utility.
- Step 2. Select **Security → Power on Password** and press Enter.  
**Note:** The administrator password must be set in advance.
- Step 3. Change the setting to **Enabled**.
- Step 4. Select **Exit → Exit Saving Changes**.

If power-on password is enabled, a prompt appears on the screen every time you turn on the computer. You must enter the administrator or user password to start the computer.

## Set hard disk password

You can set a hard disk password in the setup utility to prevent unauthorized access to your data.

**Attention:** Be extremely careful when setting a hard disk password. If you forget the hard disk password, a Lenovo authorized service personnel cannot reset your password or recover data from the hard disk. You must take your computer to a Lenovo authorized service personnel to have the hard disk drive replaced. Proof of purchase is required and a fee will be charged for parts and service.

Step 1. Open the UEFI/BIOS setup utility.

Step 2. Select **Security** → **Set Hard Disk Password** and press Enter.

**Note:** If you start the setup utility using the user password, you cannot set hard disk password.

Step 3. Follow on-screen instructions to set both master and user passwords.

**Note:** The master and user hard disk passwords must be set at the same time.

Step 4. Select **Exit** → **Exit Saving Changes**.

If the hard disk password is set, you must provide the correct password to start the operating system.

## Change or remove hard disk password

Step 1. Open the UEFI/BIOS setup utility.

Step 2. Select **Security**.

Step 3. Change or remove the hard disk password.

To change or remove master password, select **Change Master Password** and press Enter.

**Note:** If you remove the master hard disk password, the user hard disk password is also removed.

To change user password, select **Change User Password** and press Enter.

**Note:** The user hard disk password cannot be removed separately.

Step 4. Select **Exit** → **Exit Saving Changes**.

---

## Chapter 4. Help and support

---

### Frequently asked questions

#### How do I partition my storage drive

Refer to <https://support.lenovo.com/solutions/ht503851>.

#### What should I do if my computer stops responding

Press and hold the power button until the computer turns off. Then restart the computer.

#### What should I do if I spill liquid on the computer

1. Carefully unplug the ac power adapter and turn off the computer immediately. The more quickly you stop the current from passing through the computer the more likely you will reduce damage from short circuits.

**Attention:** Although you might lose some data or work by turning off the computer immediately, leaving the computer on might make your computer unusable.

2. Wait until you are certain that all the liquid is dry before turning on your computer.

**CAUTION:**

**Do not try to drain out the liquid by turning over the computer. If your computer has keyboard drainage holes on the bottom, the liquid will be drained out through the holes.**

#### Where can I get the latest device drivers and UEFI/BIOS

- Lenovo Vantage or Lenovo PC Manager
- Lenovo Support Web site at <https://support.lenovo.com>

#### Why does my screen brightness change constantly

Your computer may include an ambient light sensor and the adaptive brightness feature is enabled. The light sensor can detect the intensity of the surrounding light. Using data provided by the sensor, the operating system can dynamically adjust the screen brightness.

The adaptive brightness feature of the operating system can be disabled. For Windows operating systems, adaptive brightness settings are usually found in **Settings → System → Display**.

#### Why does my computer start automatically when I open the lid

Your computer may have Flip to Start enabled. Many Lenovo notebook computers include a sensor that can detect the angle at which the lid is opened. When you open the lid, the sensor can detect this behavior. If Flip to Start is enabled, the computer will respond by starting up automatically.

If you don't like this feature, you can disable it. Flip to Start can be enabled and disabled in:

- Lenovo Vantage, Lenovo PC Manager or Lenovo Smart Engine
- Firmware Setup Utility

---

## Self-help resources

Use the following self-help resources to learn more about the computer and troubleshoot problems.

Resources	How to access?
Troubleshooting and frequently asked questions	<ul style="list-style-type: none"><li>• <a href="https://www.lenovo.com/tips">https://www.lenovo.com/tips</a></li><li>• <a href="https://forums.lenovo.com">https://forums.lenovo.com</a></li></ul>
Accessibility information	<a href="https://www.lenovo.com/accessibility">https://www.lenovo.com/accessibility</a>
Reset or restore Windows	<ul style="list-style-type: none"><li>• Use Lenovo recovery options.<ol style="list-style-type: none"><li>1. Go to <a href="https://support.lenovo.com/HowToCreateLenovoRecovery">https://support.lenovo.com/HowToCreateLenovoRecovery</a>.</li><li>2. Follow the on-screen instructions.</li></ol></li><li>• Use Windows recovery options.<ol style="list-style-type: none"><li>1. Go to <a href="https://pcsupport.lenovo.com">https://pcsupport.lenovo.com</a>.</li><li>2. Detect your computer or manually select your computer model.</li><li>3. Click <b>Diagnostics</b> → <b>Operating System Diagnostics</b> and then follow the on-screen instructions.</li></ol></li></ul>
Use Lenovo Vantage or Lenovo PC Manager to: <ul style="list-style-type: none"><li>• Download and install the latest drivers and firmware.</li><li>• Configure hardware settings</li><li>• Diagnose computer hardware problems.</li><li>• Check the computer warranty status.</li></ul>	Use Windows Search.
Product documentation: <ul style="list-style-type: none"><li>• <a href="#">Generic Safety and Compliance Notices</a></li><li>• <a href="#">Safety and Warranty Guide</a></li><li>• <a href="#">Setup Guide</a></li><li>• <a href="#">This User Guide</a></li><li>• <a href="#">Regulatory Notice</a></li></ul>	<ol style="list-style-type: none"><li>1. Go to <a href="https://support.lenovo.com">https://support.lenovo.com</a>.</li><li>2. Detect your computer or select computer model manually.</li><li>3. Select <b>Documentation</b> and filter out the documentation you want.</li></ol>
Lenovo Support Web site with the latest support information of the following: <ul style="list-style-type: none"><li>• Drivers and software</li><li>• Diagnostic solutions</li><li>• Product and service warranty</li><li>• Product and parts details</li><li>• Knowledge base and frequently asked questions</li></ul>	Visit <a href="https://support.lenovo.com">https://support.lenovo.com</a>
Windows help information	<ul style="list-style-type: none"><li>• Use <b>Get Help</b> or <b>Tips</b>.</li><li>• Use Windows Search or the Cortana® personal assistant.</li><li>• Microsoft support Web site: <a href="https://support.microsoft.com">https://support.microsoft.com</a></li></ul>

---

## What is a CRU?

Customer replaceable units (CRUs) are parts that can be upgraded or replaced by the customer. A Lenovo computer may contain the following types of CRUs:

### Self-service CRU

Parts that can be installed or replaced easily by customer themselves or by trained service technicians at an additional cost.

### Optional-service CRU

Parts that can be installed or replaced by customers with a greater skill level. Trained service technicians can also provide service to install or replace the parts under the type of warranty designated for the customer's machine.

If you intend to install a CRU, Lenovo will ship the CRU to you. You might be required to return the defective part that is replaced by the CRU. When return is required: (1) return instructions, a prepaid shipping label, and a container will be included with the replacement CRU; and (2) you might be charged for the replacement CRU if Lenovo does not receive the defective CRU within thirty (30) days of your receipt of the replacement CRU. For full details, see the *Lenovo Limited Warranty* at [https://www.lenovo.com/warranty/llw\\_02](https://www.lenovo.com/warranty/llw_02).

---

## CRUs for your product model

The table below lists the CRUs and CRU types that are defined for your product model.

Part	Self-service CRU	Optional-service CRU
Power cord	X	
ac power adapter	X	

### Notes:

- CRU replacement instruction is provided in one or more of the following publications and are available from Lenovo at any time upon your request.
  - the product *User Guide*
  - the printed publications that came with the product
- Replacement of any parts not listed above, including the built-in rechargeable battery, must be done by a Lenovo-authorized repair facility or technician. Go to <https://support.lenovo.com/partnerlocation> for more information.

---

## Call Lenovo

If you have tried to correct the problem yourself and still need help, you can call Lenovo Customer Support Center.

## Before you contact Lenovo

Record product information and problem details before you contact Lenovo.

Product information	Problem symptoms and details
<ul style="list-style-type: none"> <li>• Product name</li> <li>• Machine type and serial number</li> </ul>	<ul style="list-style-type: none"> <li>• What is the problem? Is it continuous or intermittent?</li> <li>• Any error message or error code?</li> <li>• What operating system are you using? Which version?</li> <li>• Which software applications were running at the time of the problem?</li> <li>• Can the problem be reproduced? If so, how?</li> </ul>

**Note:** The product name and serial number can usually be found on the bottom of the computer, either printed on a label or etched on the cover.

## Lenovo Customer Support Center

During the warranty period, you can call Lenovo Customer Support Center for help.

### Telephone numbers

For a list of the Lenovo Support phone numbers for your country or region, go to <https://pcsupport.lenovo.com/supportphonenumberlist>.

**Note:** Phone numbers are subject to change without notice. If the number for your country or region is not provided, contact your Lenovo reseller or Lenovo marketing representative.

### Services available during the warranty period

- Problem determination - Trained personnel are available to assist you with determining if you have a hardware problem and deciding what action is necessary to fix the problem.
- Lenovo hardware repair - If the problem is determined to be caused by Lenovo hardware under warranty, trained service personnel are available to provide the applicable level of service.
- Engineering change management - Occasionally, there might be changes that are required after a product has been sold. Lenovo or your reseller, if authorized by Lenovo, will make selected Engineering Changes (ECs) that apply to your hardware available.

### Services not covered

- Replacement or use of parts not manufactured for or by Lenovo or nonwarranted parts
- Identification of software problem sources
- Configuration of UEFI/BIOS as part of an installation or upgrade
- Changes, modifications, or upgrades to device drivers
- Installation and maintenance of network operating systems (NOS)
- Installation and maintenance of programs

For the terms and conditions of the Lenovo Limited Warranty that apply to your Lenovo hardware product, see “Warranty information” in the *Safety and Warranty Guide* that comes with your computer.

## Purchase additional services

During and after the warranty period, you can purchase additional services from Lenovo at <https://pcsupport.lenovo.com/warrantyupgrade>.

Service availability and service name might vary by country or region.



## Appendix A. Function descriptions for Lenovo hotkeys

Hotkey functions are denoted by the icons printed on the keys. The following table describes the functions for all Lenovo hotkeys. The keyboard of your Lenovo computer should only support a subset of the listed hotkeys.

Table 6. Hotkey icons and denoted functions

































Hotkey icon	Function description
	Mutes/Unmutes sound.
	Increases volume.
	Decreases volume.
	Enables/Disables the microphone.
	Increases screen brightness.
	Decreases screen brightness.
	Selects and sets up display devices.
	Enables/Disables airplane mode. (Windows operating systems)
	Displays the Lenovo Smart Key quick launch panel.
	Enables/Disables the touchpad.
	Displays all open apps as thumbnails. (Windows operating systems)
	Opens the Calculator app. (Windows operating systems)
	Opens the Snipping tool. (Windows operating systems)
	Opens the Settings app. (Windows operating systems)
	Locks the screen. (Windows operating systems)
	Opens the clipboard history. (Windows operating systems)
	Puts the computer to sleep.
	Opens the context menu of the current active app.
	Opens an associated voice app, voice service, or Microsoft Cortana.
	Adjusts the keyboard backlight.
	Increases the brightness of the keyboard backlight.
	Decreases the brightness of the keyboard backlight.
	Answers an incoming Microsoft Teams call.
	Rejects an incoming Microsoft Teams call.
	Accesses Lenovo Support resources.
	Starts/Pauses audio or video playback.
	Stops audio or video playback.
	Plays the previous audio or video in the playlist.

Table 6. Hotkey icons and denoted functions (continued)

Hotkey icon	Function description
	Plays the next audio or video in the playlist.
	Switches the computer's active operation mode.
	Blurs the background for videoconferencing.
	Switches the computer's active audio mode.
	Turns on/off night light mode. (Windows operating systems)

**Note:** Hotkey functions may change if the associated app or the Windows operating system is updated.

---

## Appendix B. Notices and trademarks

### Notices

Lenovo may not offer the products, services, or features discussed in this document in all countries. Consult your local Lenovo representative for information on the products and services currently available in your area. Any reference to a Lenovo product, program, or service is not intended to state or imply that only that Lenovo product, program, or service may be used. Any functionally equivalent product, program, or service that does not infringe any Lenovo intellectual property right may be used instead. However, it is the user's responsibility to evaluate and verify the operation of any other product, program, or service.

Lenovo may have patents or pending patent programs covering subject matter described in this document. The furnishing of this document does not give you any license to these patents. You can send license inquiries, in writing, to:

Lenovo (United States), Inc.  
8001 Development Drive  
Morrisville, NC 27560  
U.S.A.

Attention: Lenovo Director of Licensing

LENOVO PROVIDES THIS PUBLICATION "AS IS" WITHOUT WARRANTY OF ANY KIND, EITHER EXPRESS OR IMPLIED, INCLUDING, BUT NOT LIMITED TO, THE IMPLIED WARRANTIES OF NON-INFRINGEMENT, MERCHANTABILITY OR FITNESS FOR A PARTICULAR PURPOSE. Some jurisdictions do not allow disclaimer of express or implied warranties in certain transactions, therefore, this statement may not apply to you.

Changes are made periodically to the information herein; these changes will be incorporated in new editions of the publication. To provide better service, Lenovo reserves the right to improve and/or modify the products and software programs described in the manuals included with your computer, and the content of the manual, at any time without additional notice.

The software interface and function and hardware configuration described in the manuals included with your computer might not match exactly the actual configuration of the computer that you purchase. For the configuration of the product, refer to the related contract (if any) or product packing list, or consult the distributor for the product sales. Lenovo may use or distribute any of the information you supply in any way it believes appropriate without incurring any obligation to you.

The products described in this document are not intended for use in implantation or other life support applications where malfunction may result in injury or death to persons. The information contained in this document does not affect or change Lenovo product specifications or warranties. Nothing in this document shall operate as an express or implied license or indemnity under the intellectual property rights of Lenovo or third parties. All information contained in this document was obtained in specific environments and is presented as an illustration. The result obtained in other operating environments may vary.

Lenovo may use or distribute any of the information you supply in any way it believes appropriate without incurring any obligation to you.

Any references in this publication to non-Lenovo Web sites are provided for convenience only and do not in any manner serve as an endorsement of those Web sites. The materials at those Web sites are not part of the materials for this Lenovo product, and use of those Web sites is at your own risk.

Any performance data contained herein was determined in a controlled environment. Therefore, the result obtained in other operating environments may vary significantly. Some measurements may have been made on development-level systems and there is no guarantee that these measurements will be the same on generally available systems. Furthermore, some measurements may have been estimated through extrapolation. Actual results may vary. Users of this document should verify the applicable data for their specific environment.

This document is copyrighted by Lenovo and is not covered by any open source license, including any Linux agreement(s) which may accompany software included with this product. Lenovo may update this document at any time without notice.

For the latest information or any questions or comments, contact or visit the Lenovo Web site:

<https://support.lenovo.com>

### **Trademarks**

Lenovo and the Lenovo logo are trademarks of Lenovo. Thunderbolt is a trademark of Intel Corporation or its subsidiaries. Microsoft, Windows, Windows Hello, OneDrive, Outlook, Skype, Office 365, Direct3D, and Cortana are trademarks of the Microsoft group of companies. DisplayPort is a trademark of the Video Electronics Standards Association. The terms HDMI and HDMI High-Definition Multimedia Interface, and the HDMI logo are trademarks or registered trademarks of HDMI Licensing Administrator, Inc. in the United States and other countries. Wi-Fi is a registered trademark of Wi-Fi Alliance. USB Type-C is a registered trademark of USB Implementers Forum. All other trademarks are the property of their respective owners.