

LASER PEGS

It's Your Imagination, Light it Up!™

www.LaserPegs.com/MISSION CONTROL/18004

MISSION MARS



 **WARNING: CHOKING HAZARD-**
Small Parts. Not for children under 3 yrs.

 **ATTENTION: DANGER DE SUFFOCATION.**
- Petits éléments. Ne convient pas aux enfants de moins de trois ans.

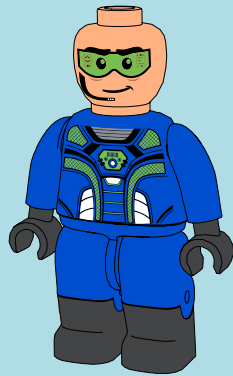
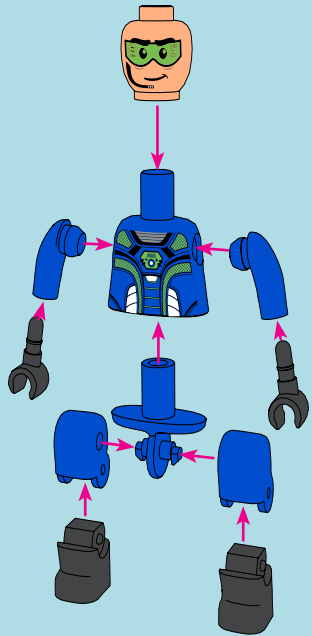
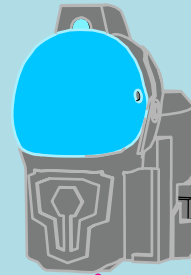
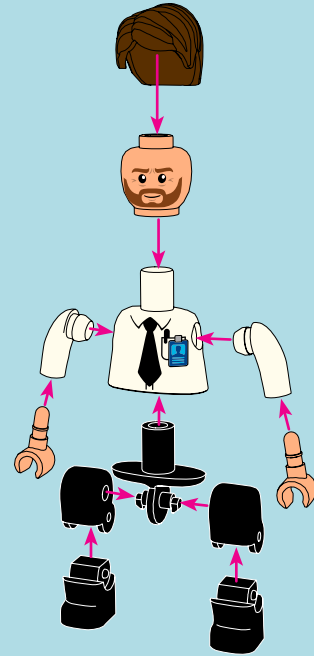
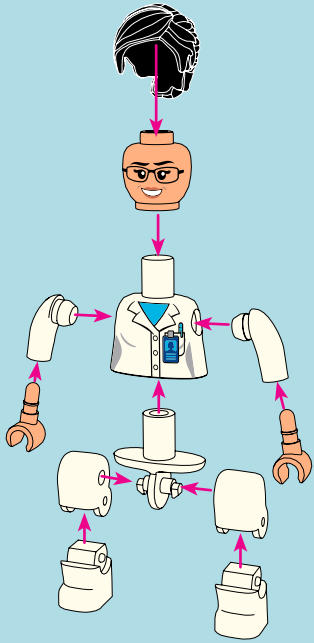

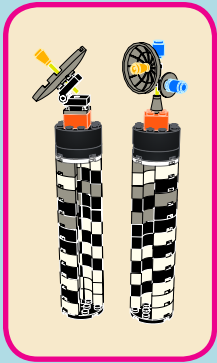

- x2
- x10
- x20
- x18

- x2
- x10
- x12

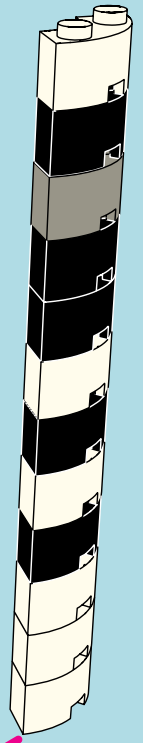
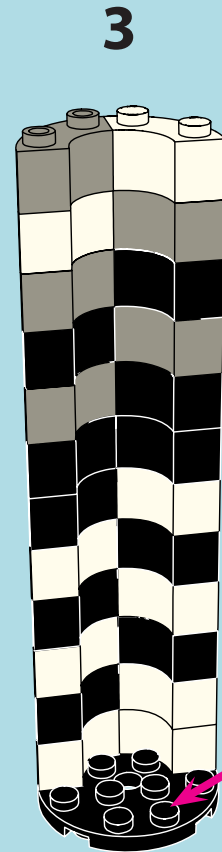
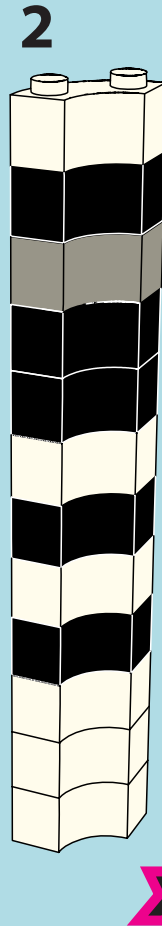
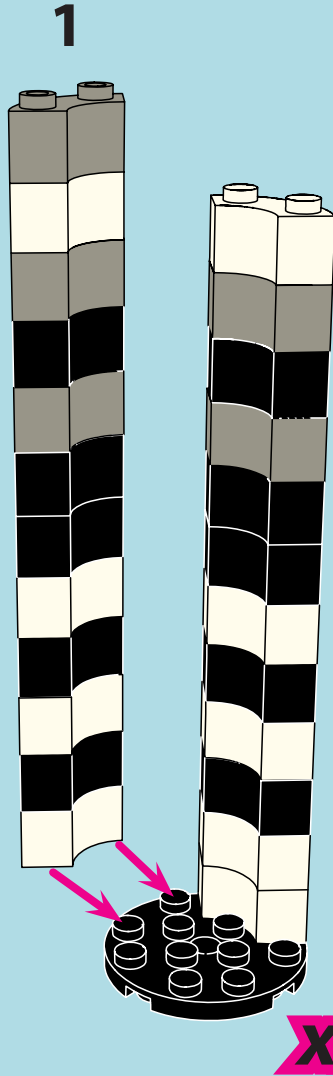

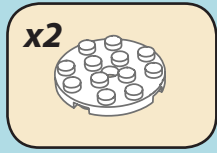

4



x2

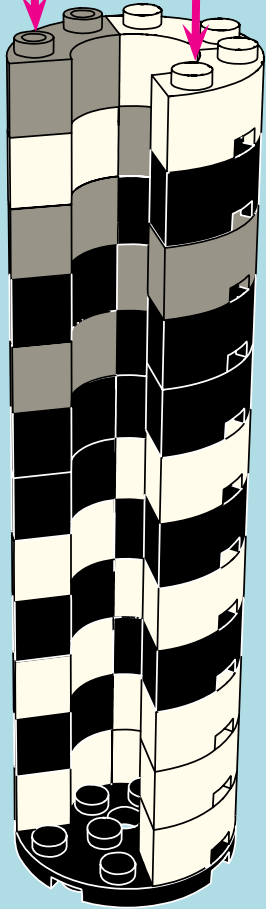

4b

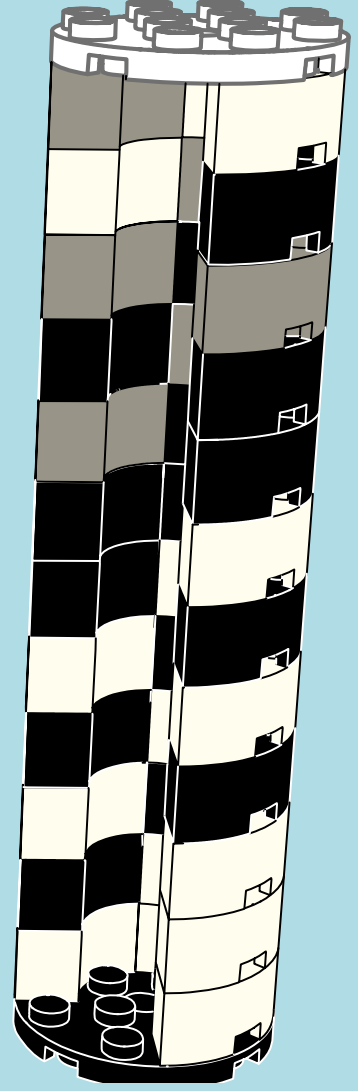
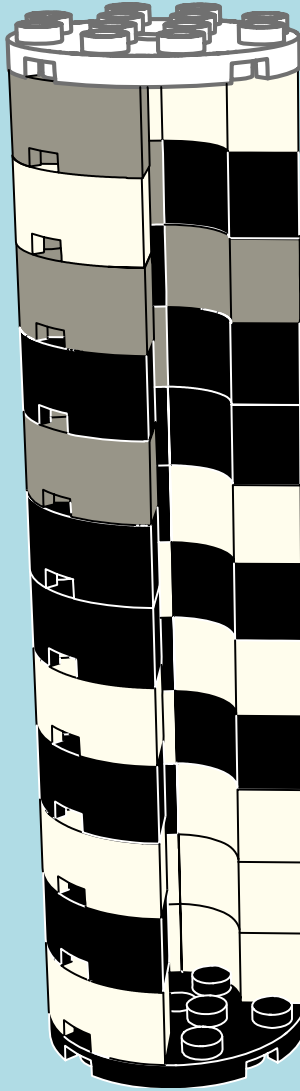

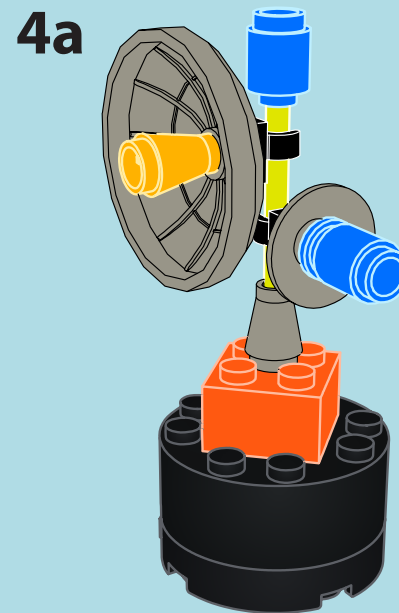
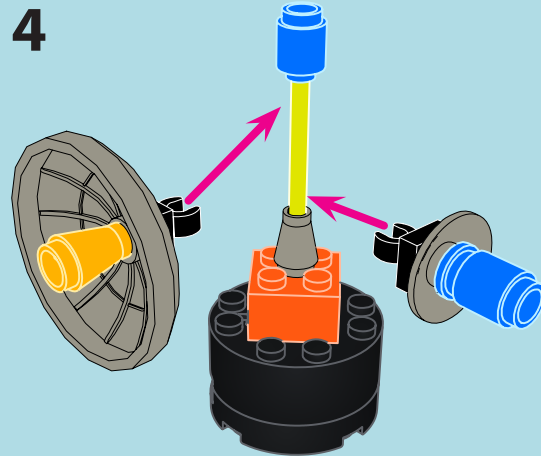
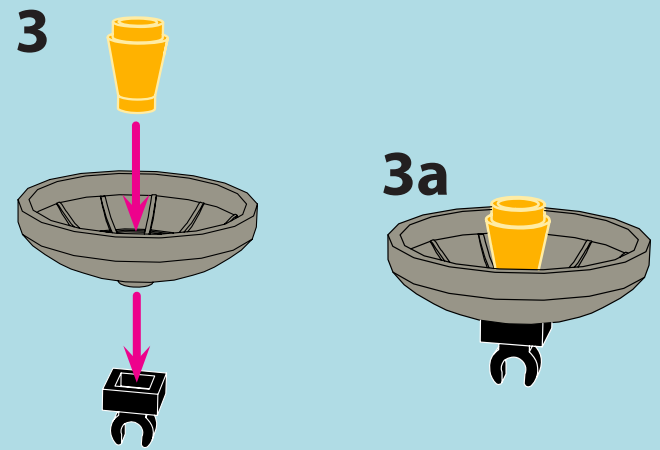
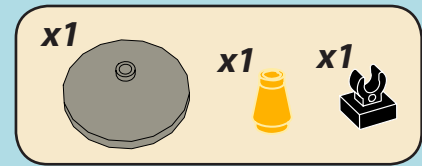
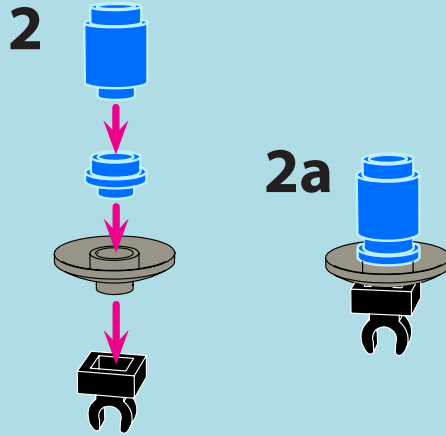
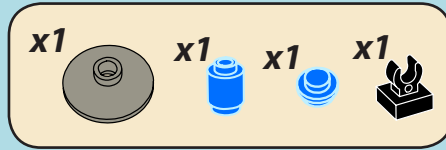
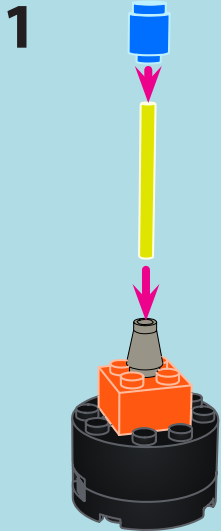
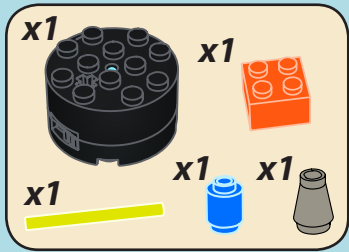

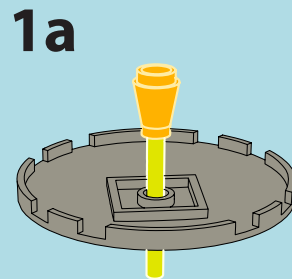
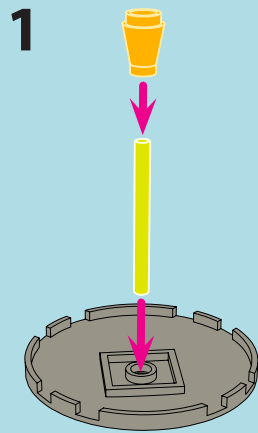
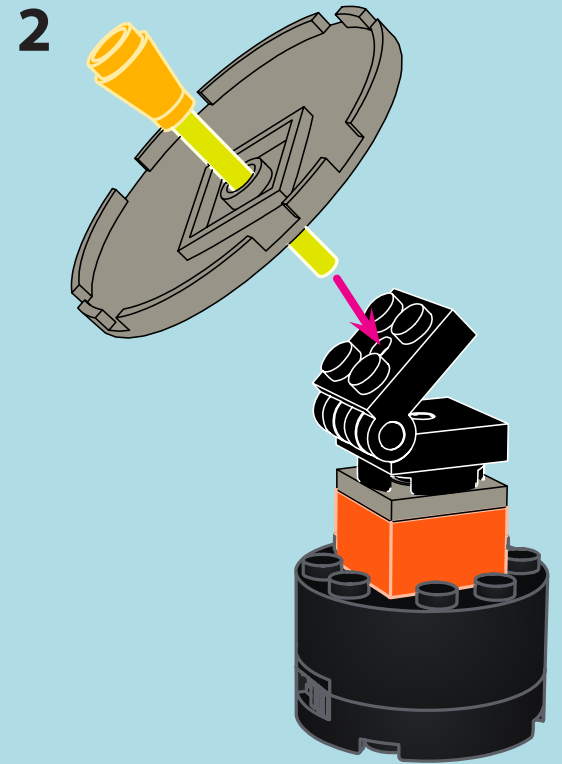
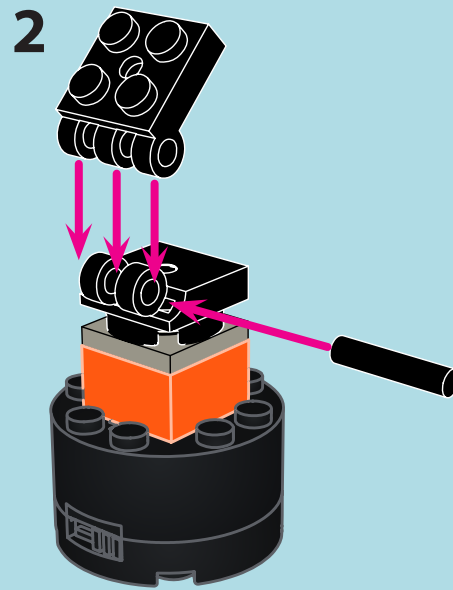
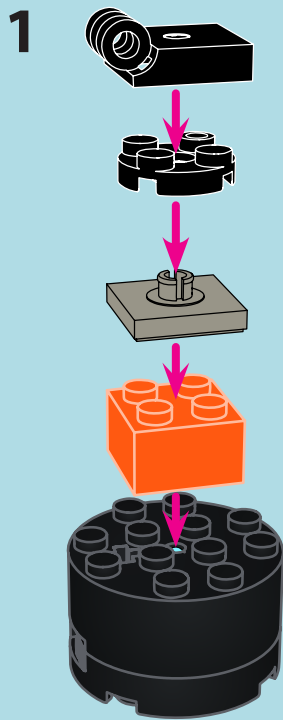
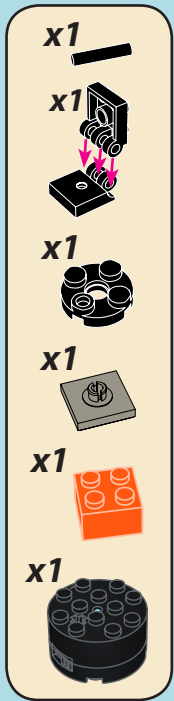

2a

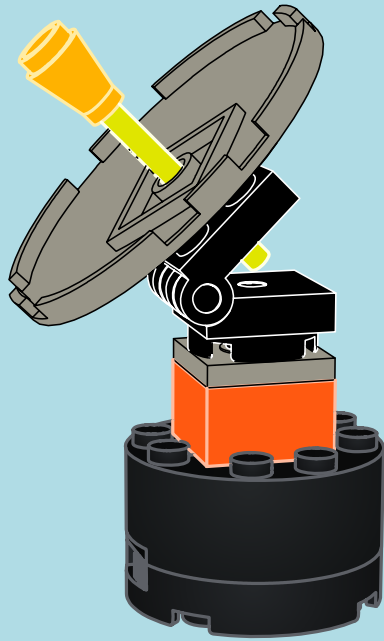

x1

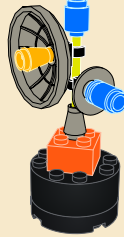

x1

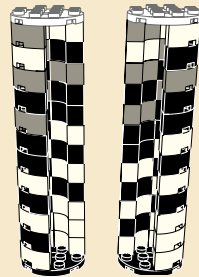
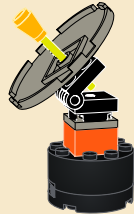

3

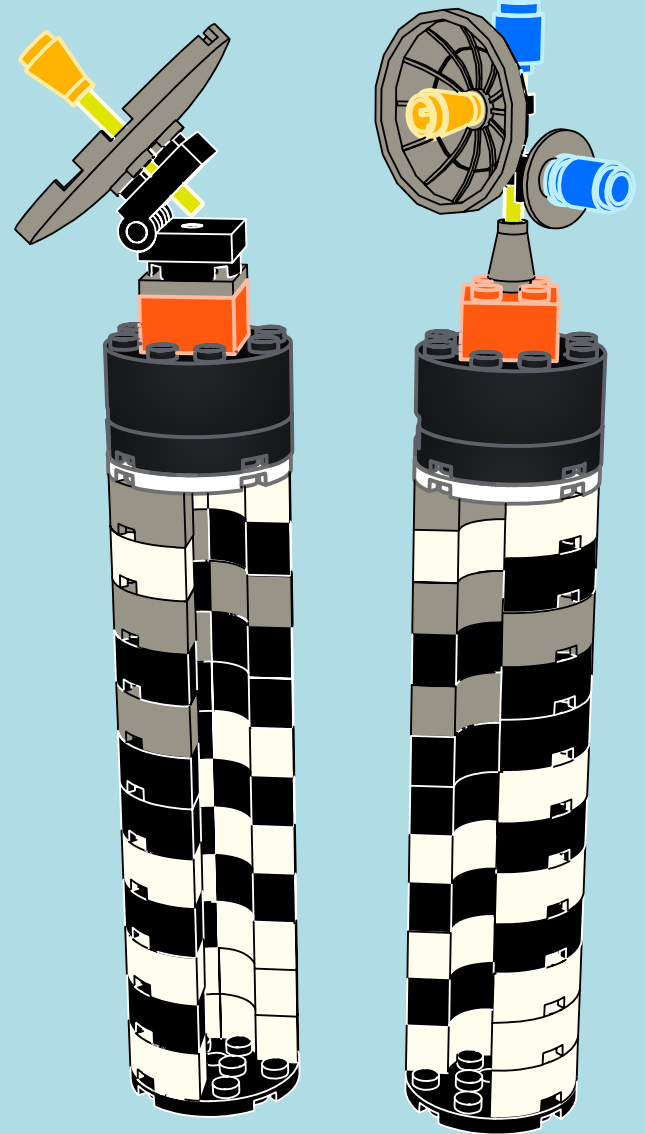

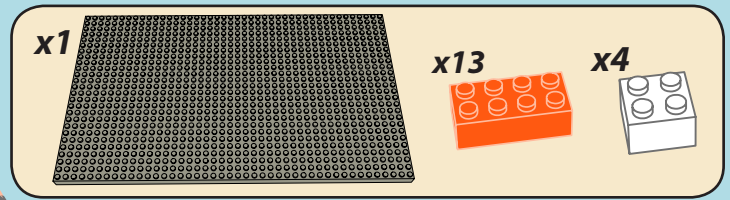
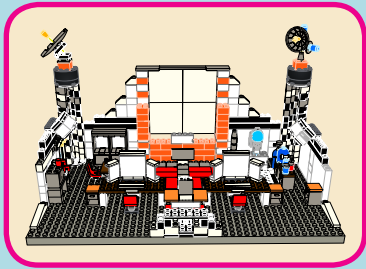

1

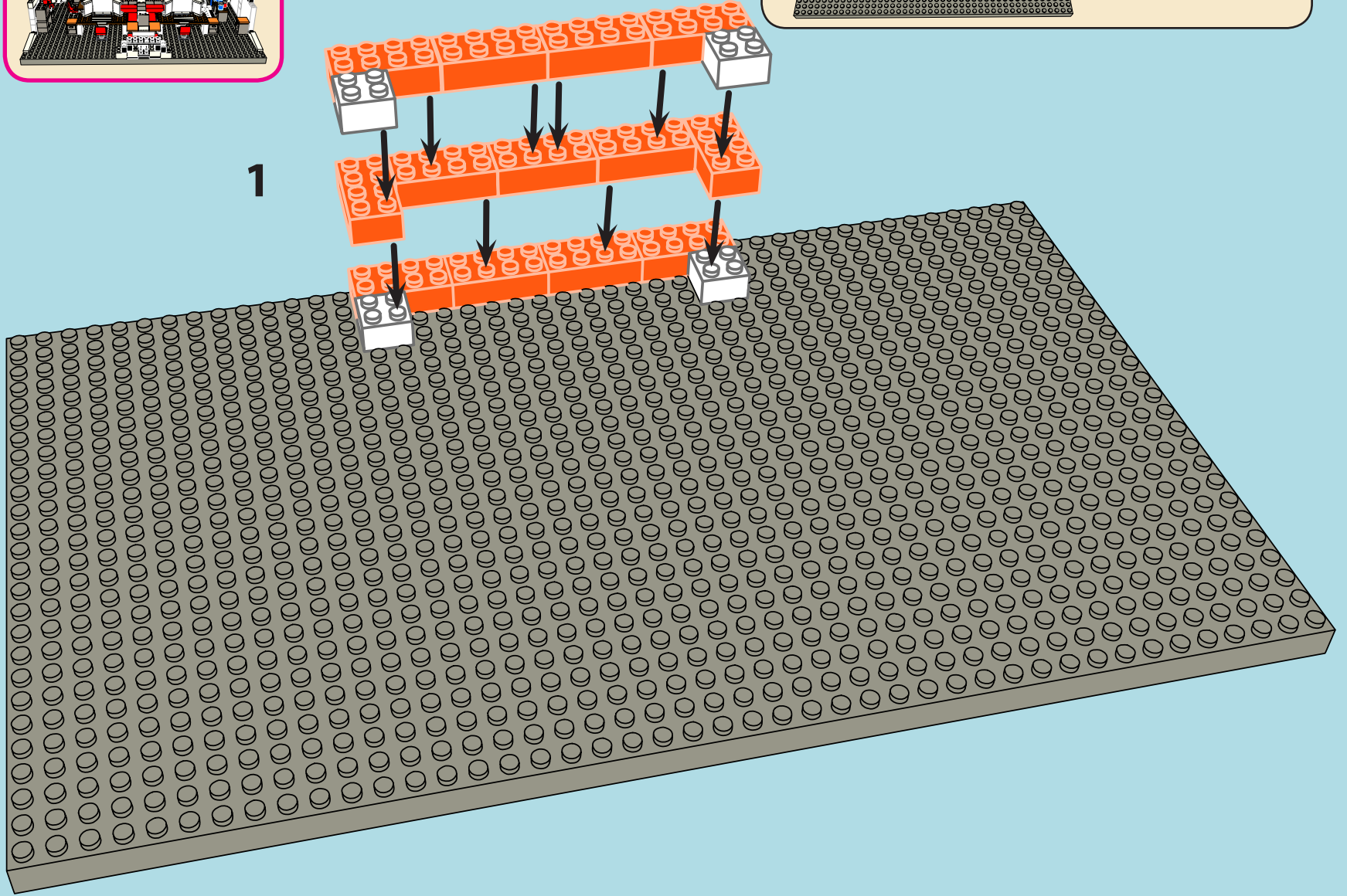

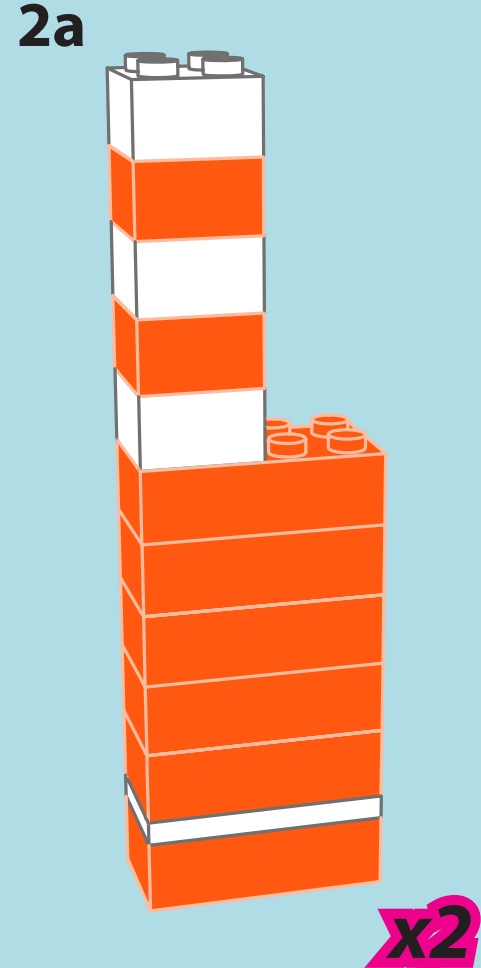
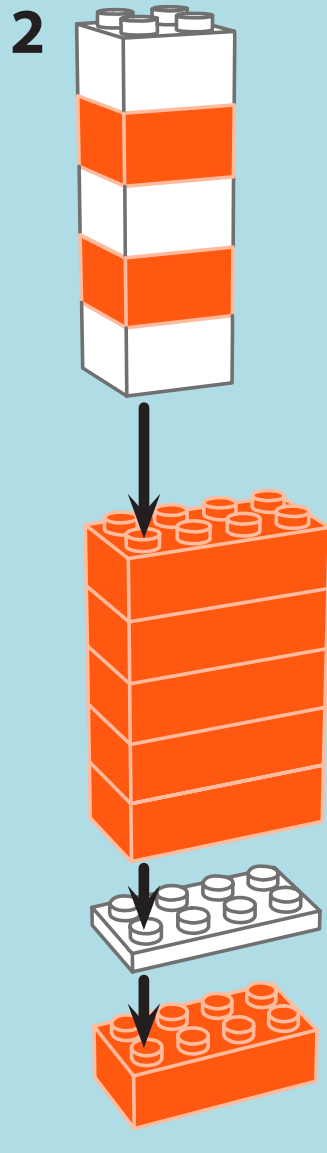
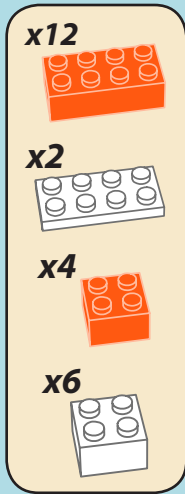

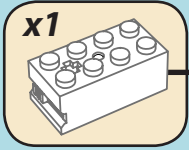

3

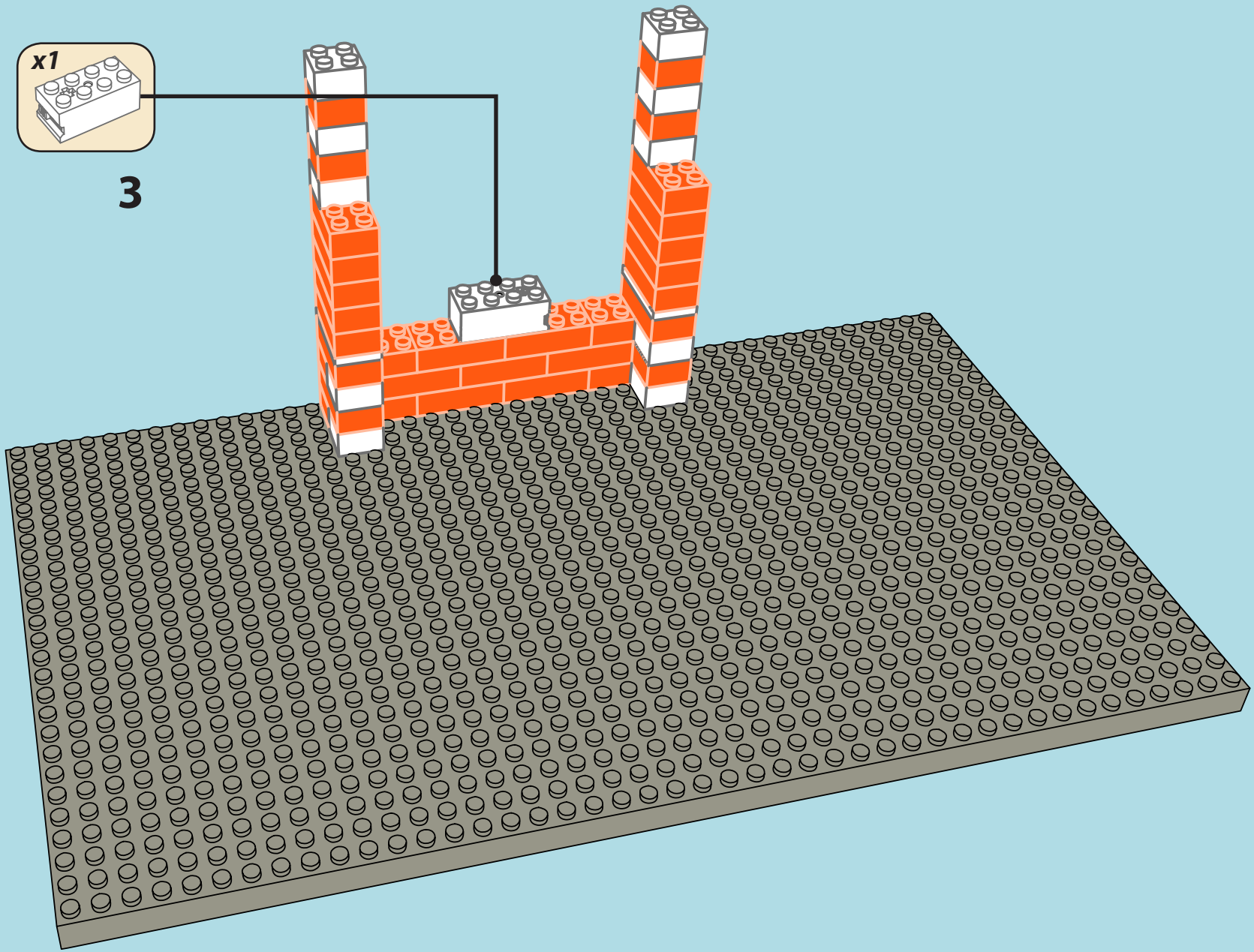

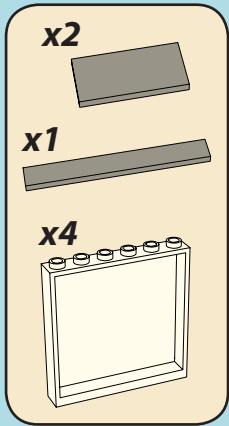

4

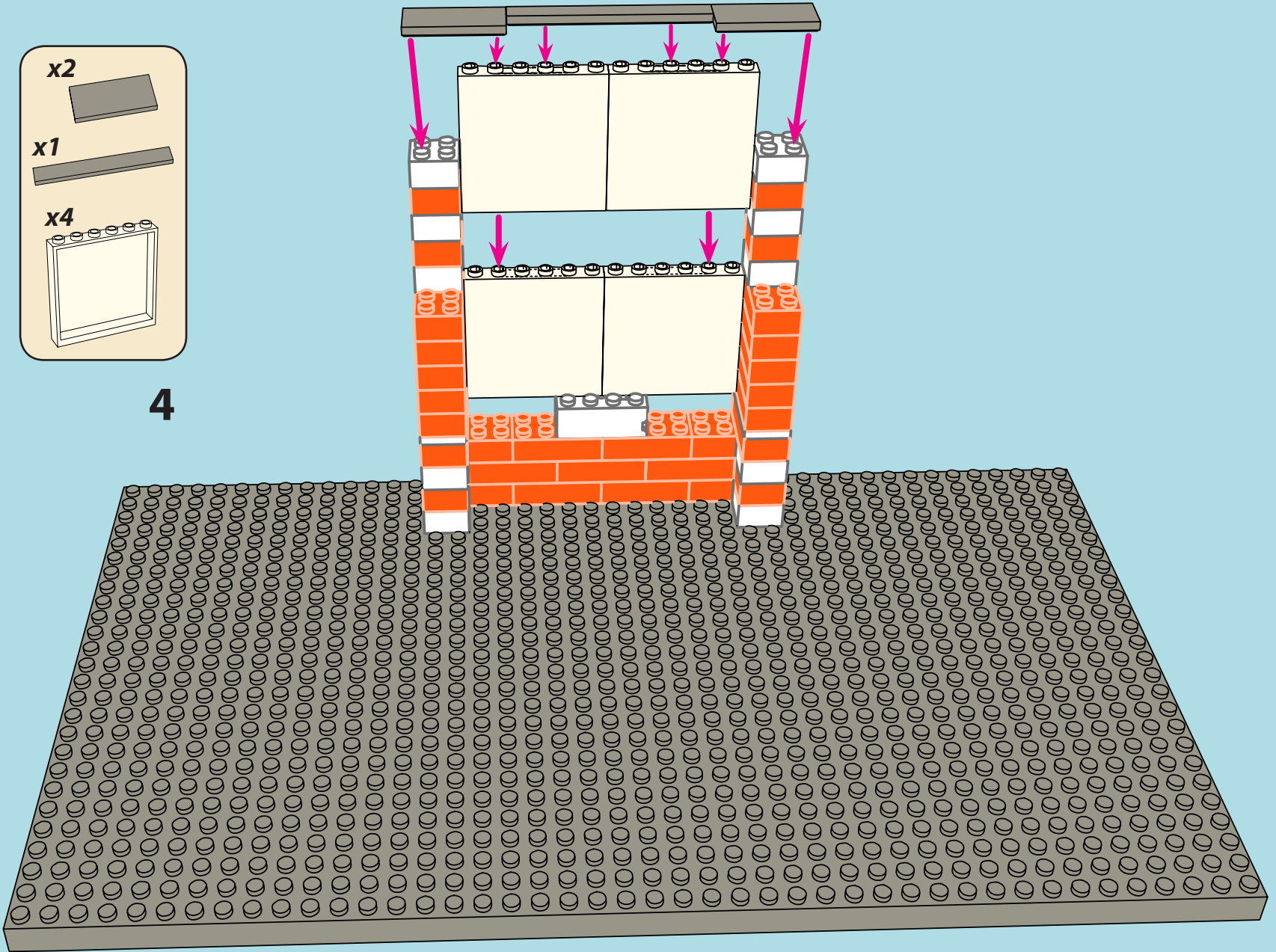

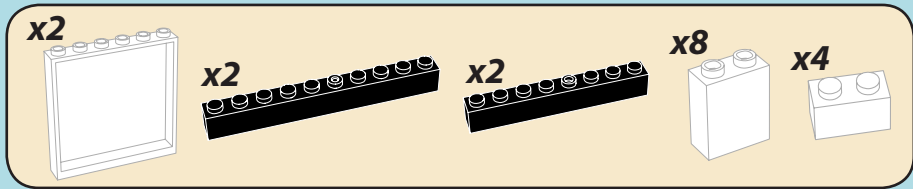

1

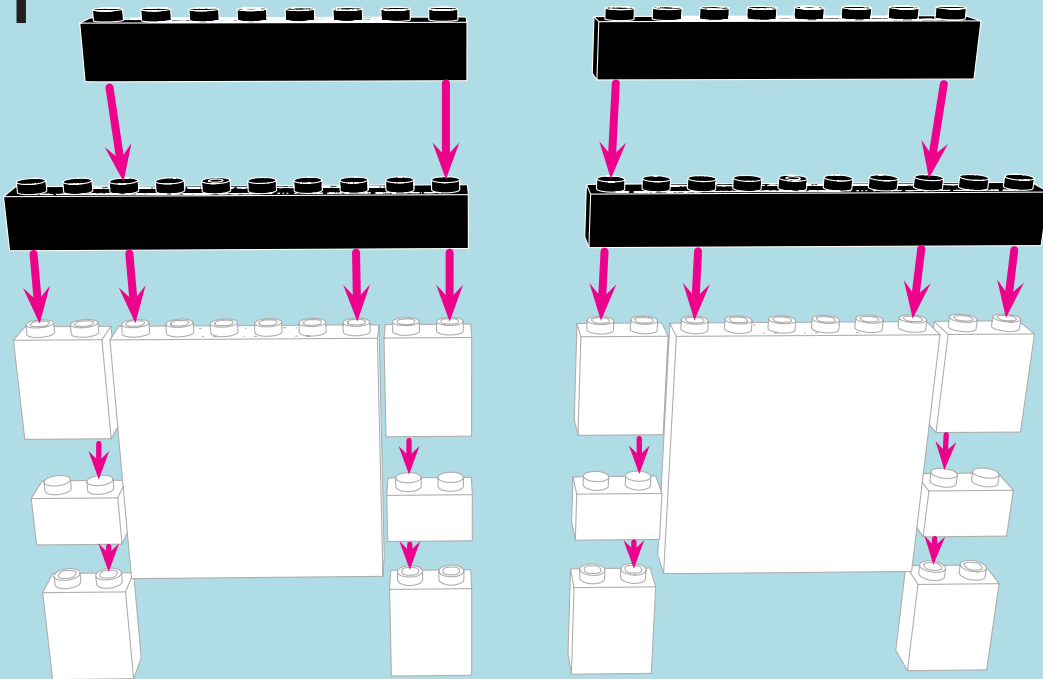

1a

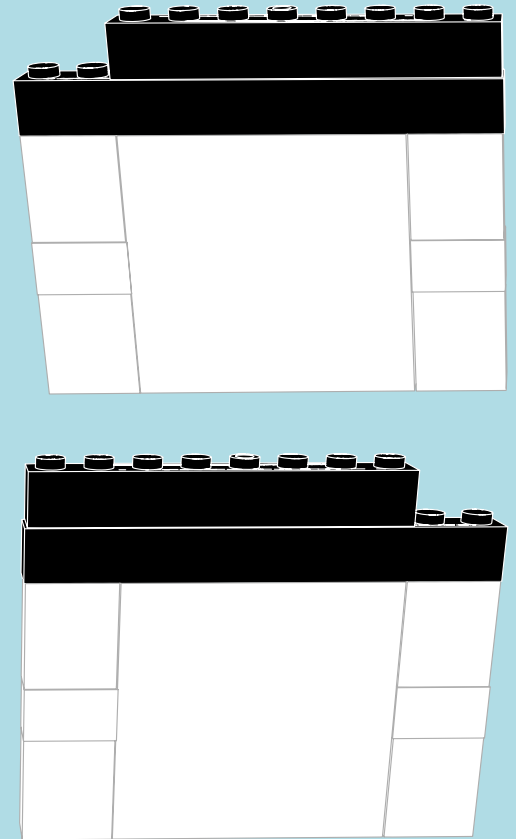

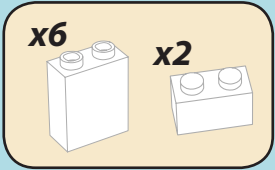

2

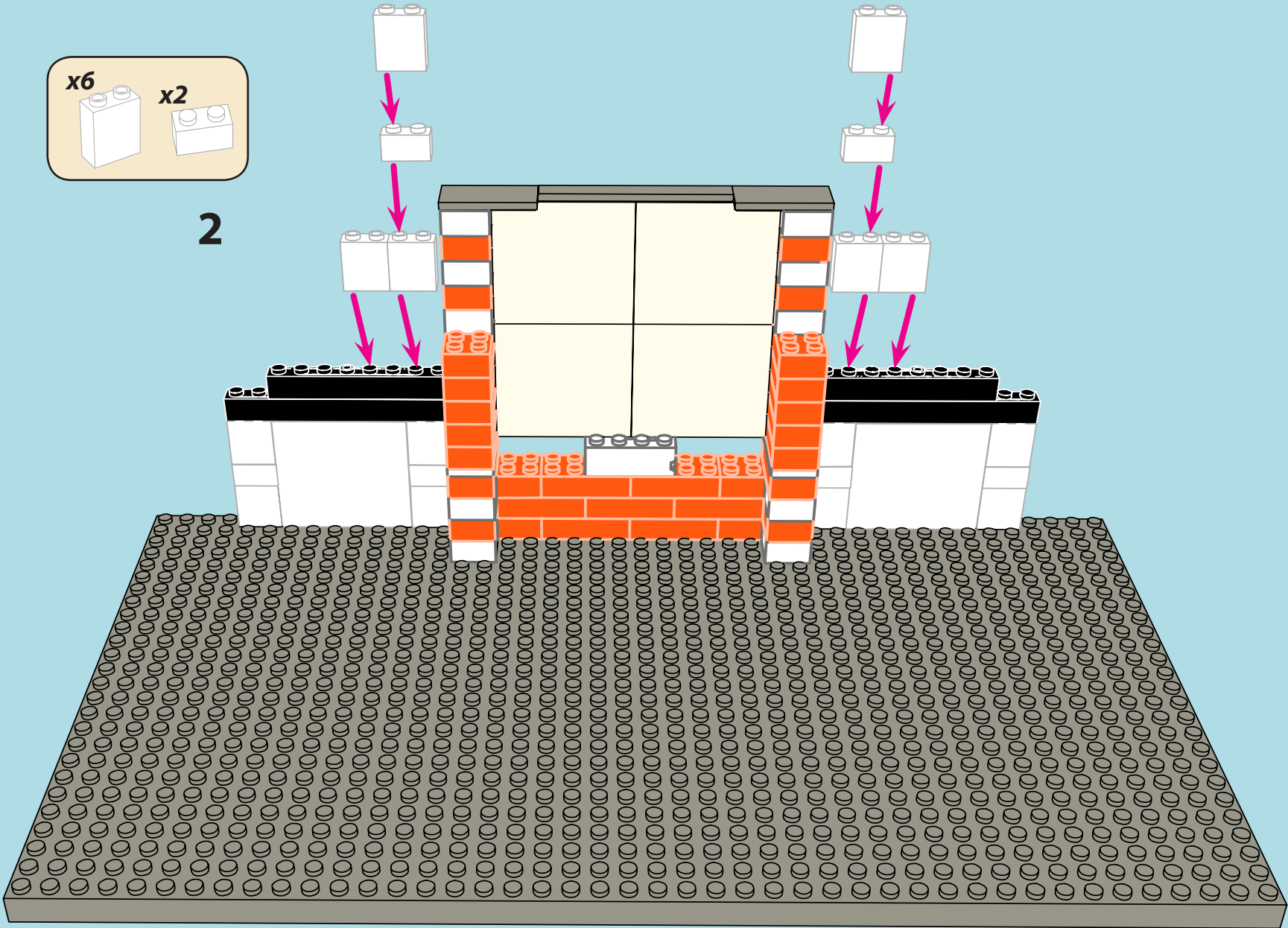

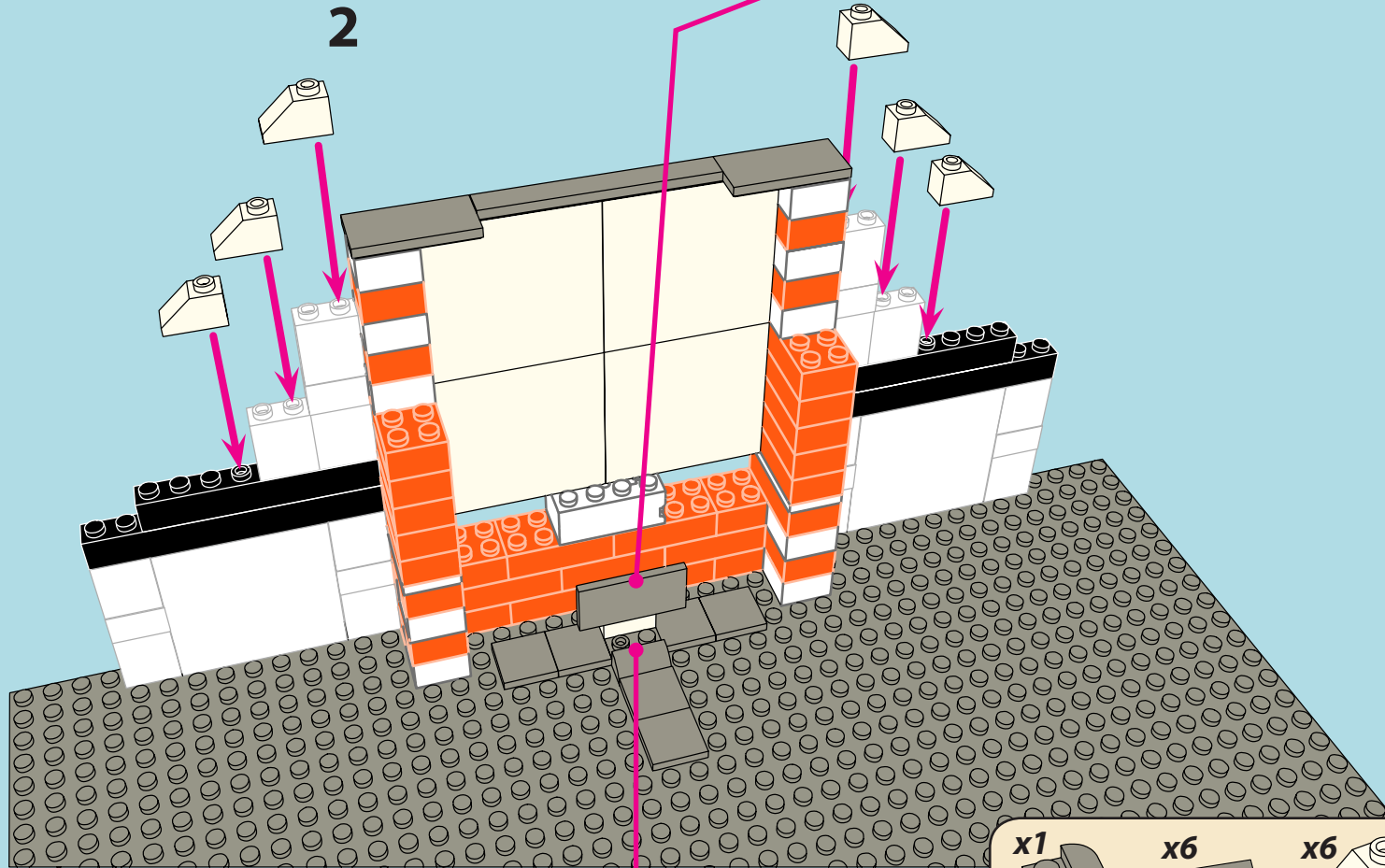
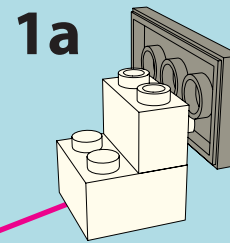
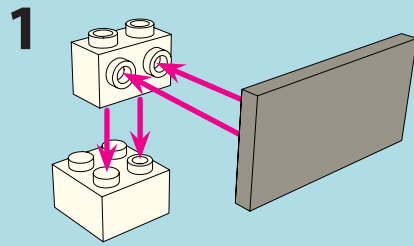
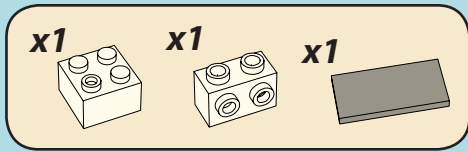

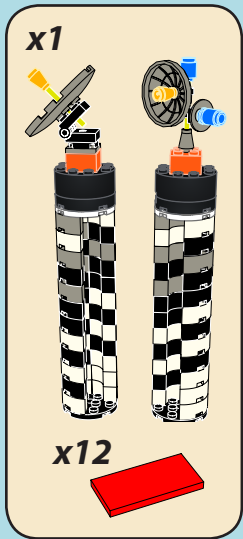

3

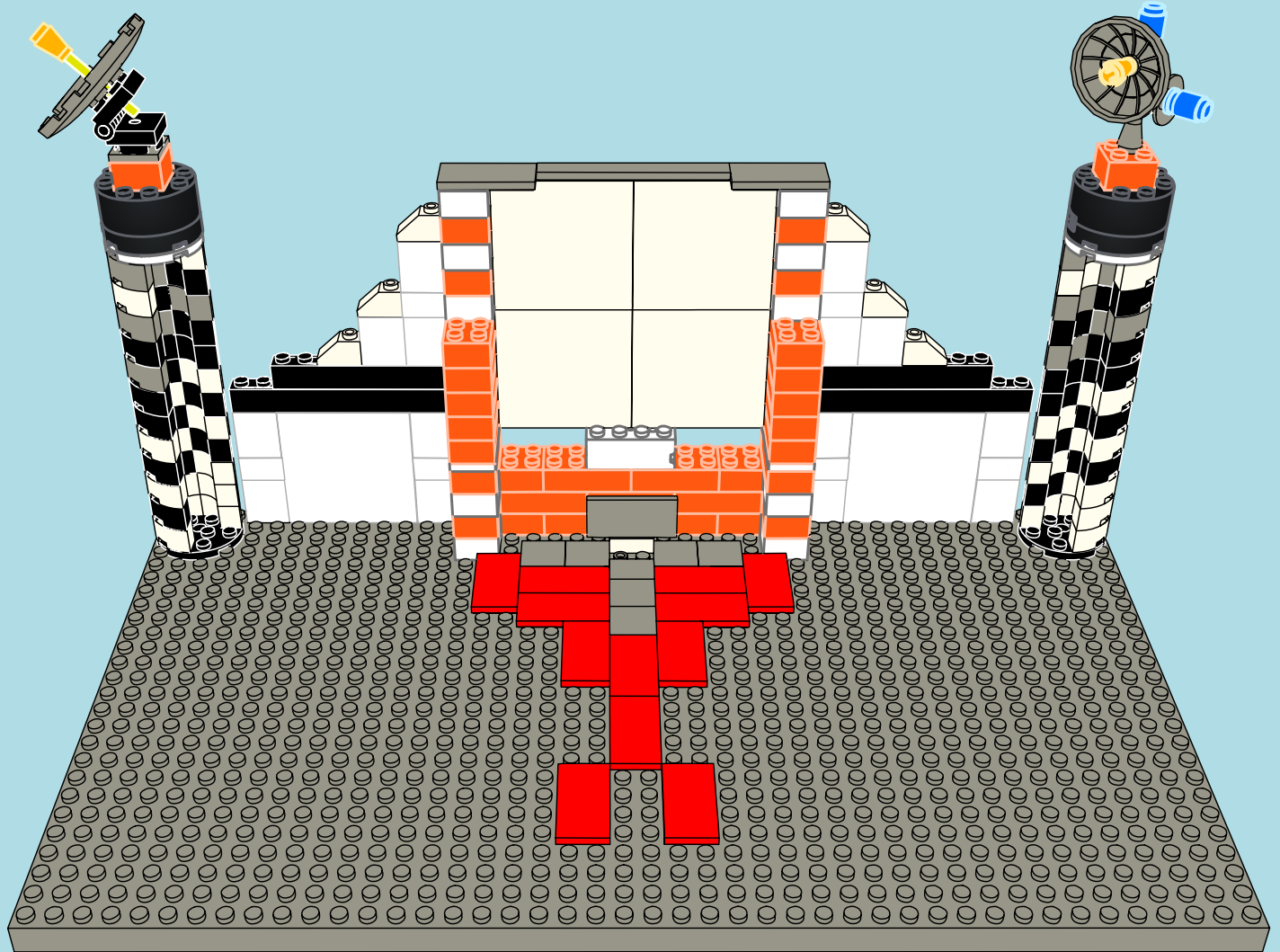

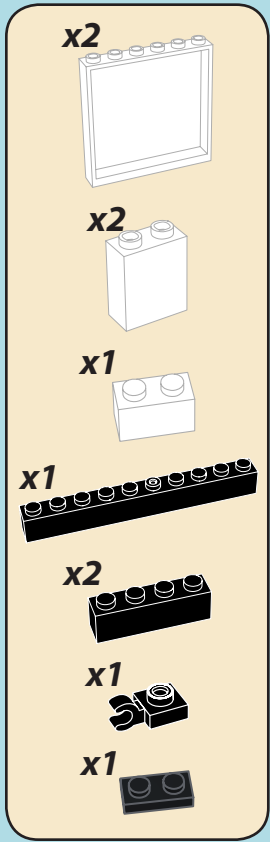

1

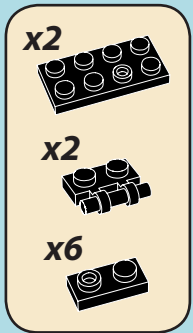
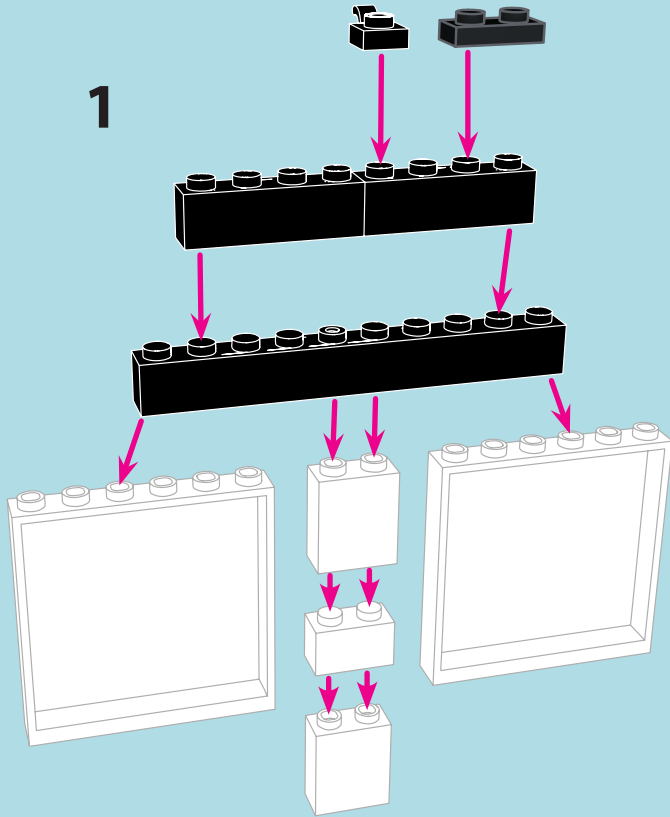

2

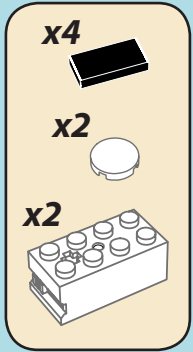
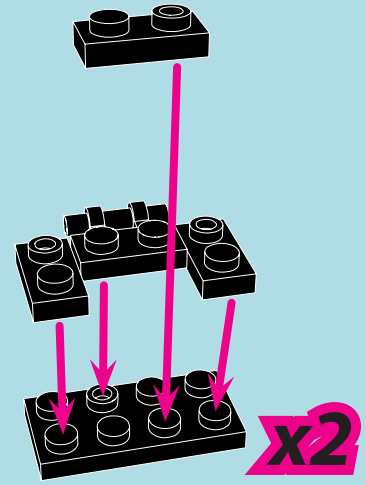

3

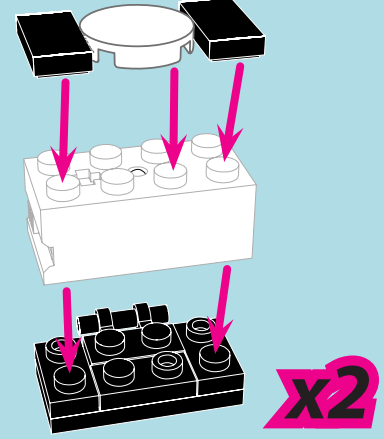

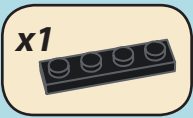

4

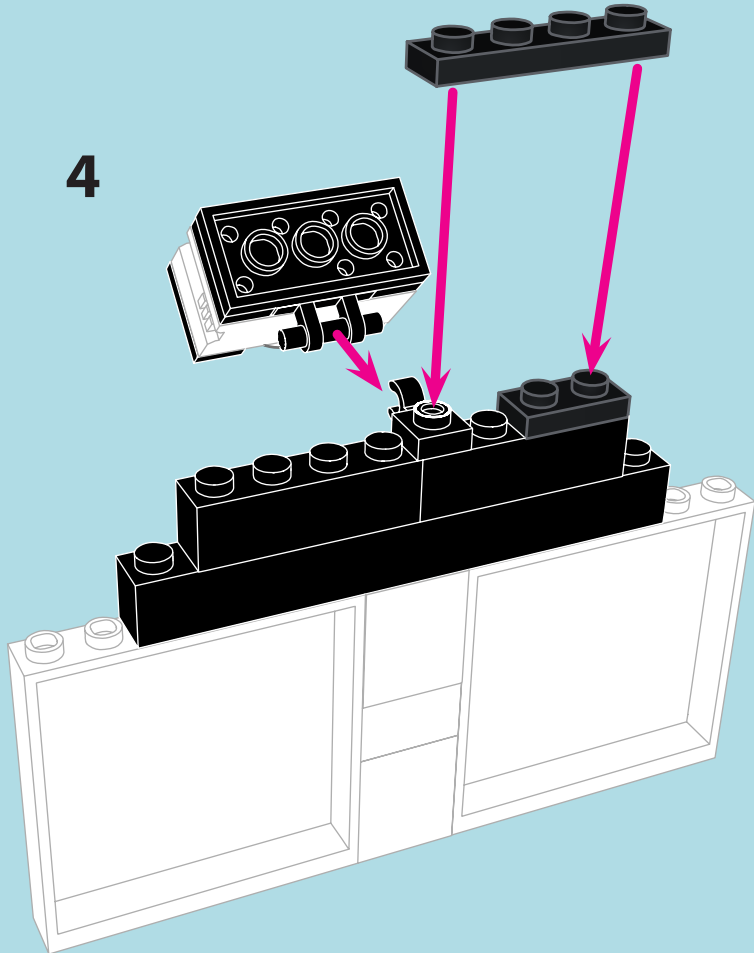

4a

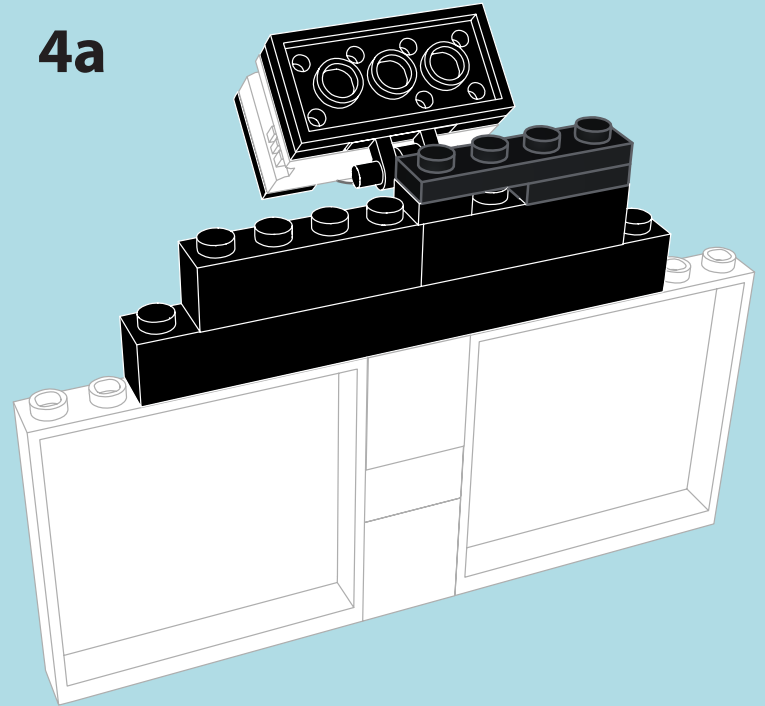

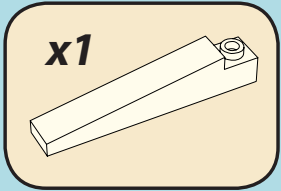

5

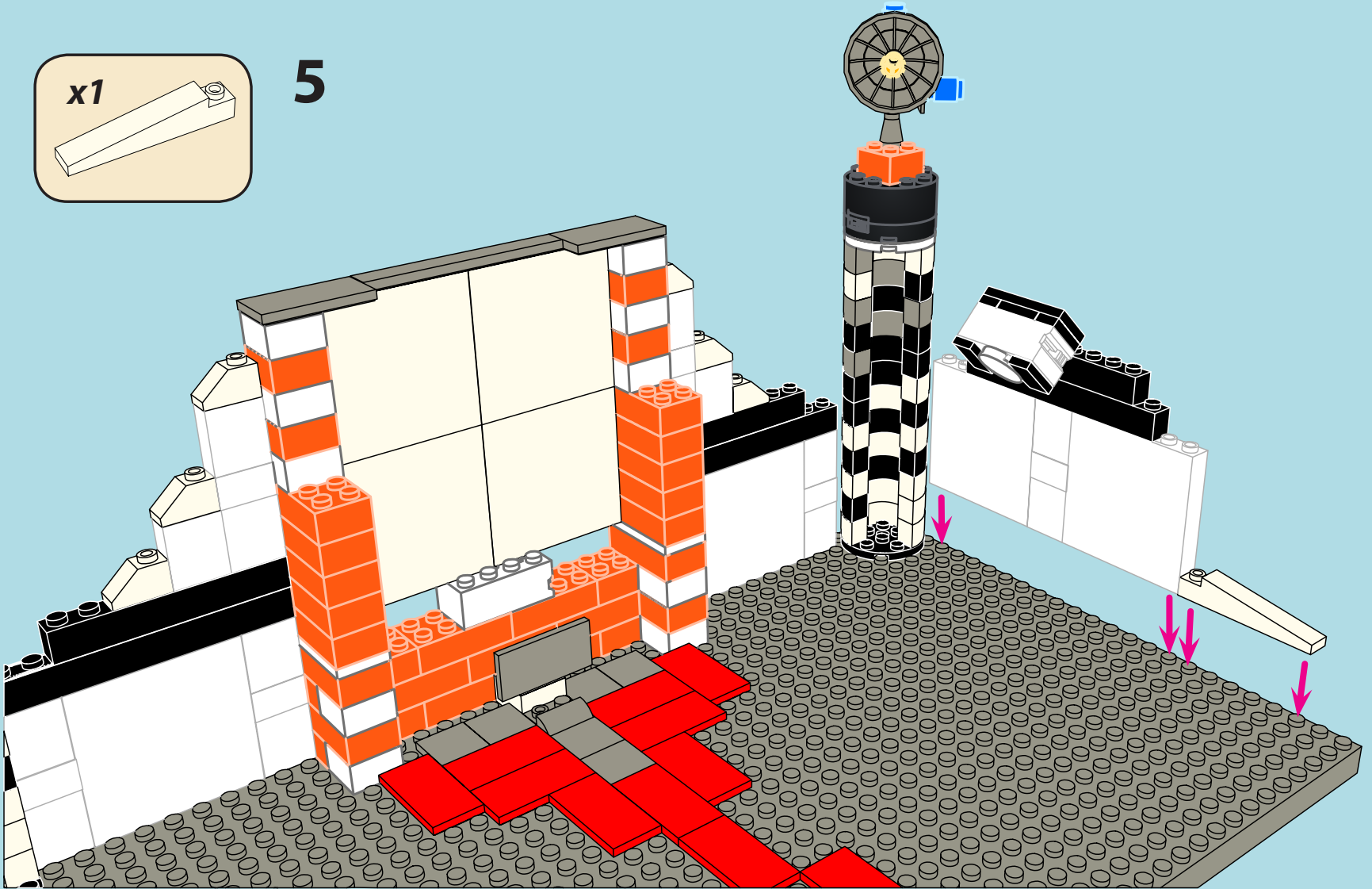

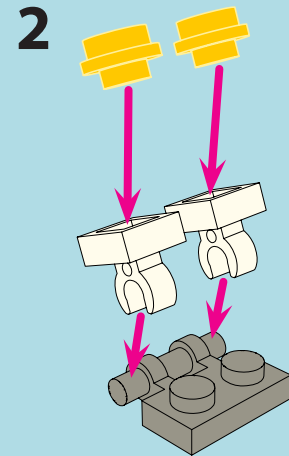
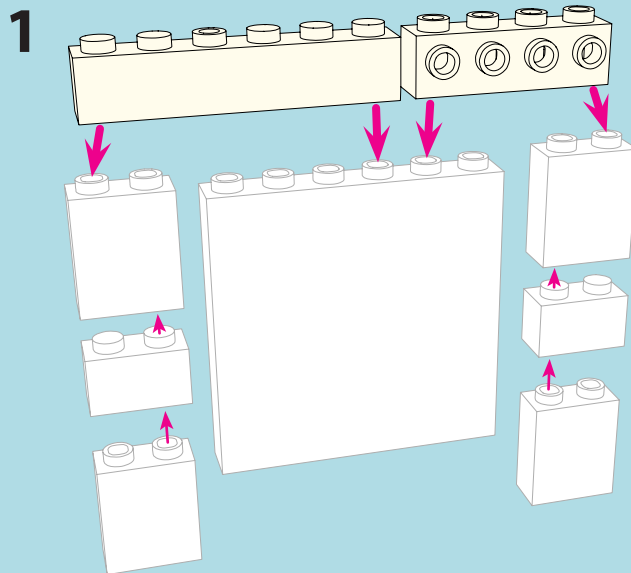
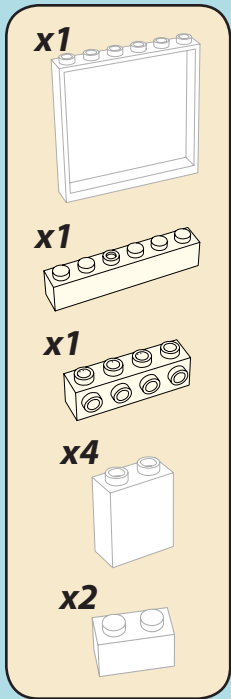
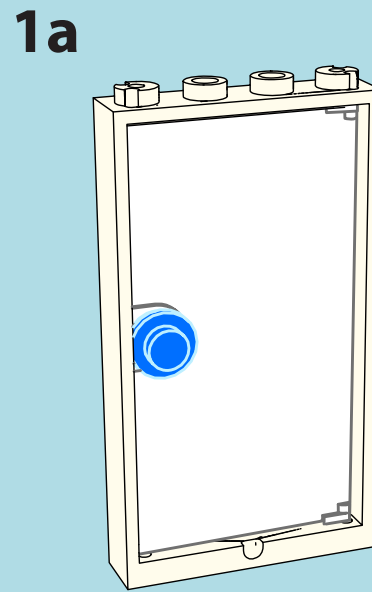
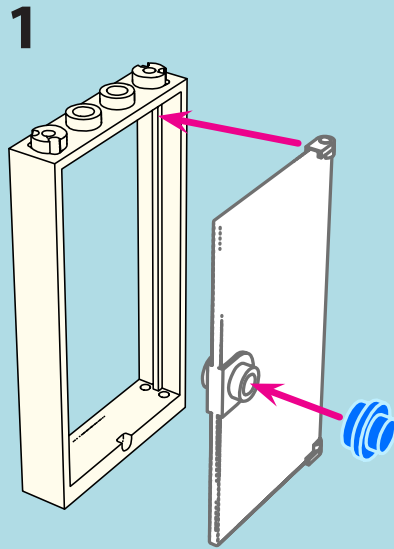
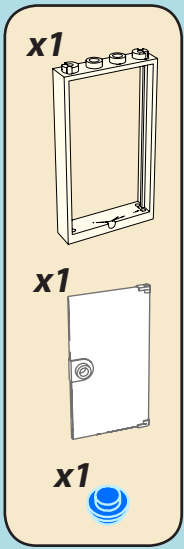

3

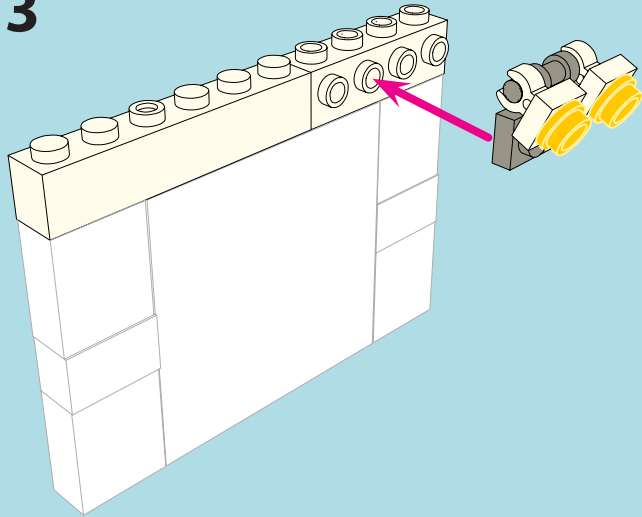

3a

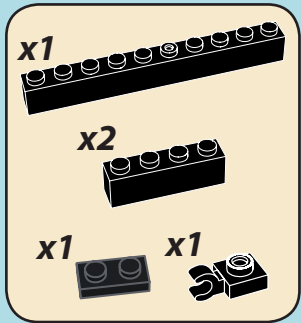
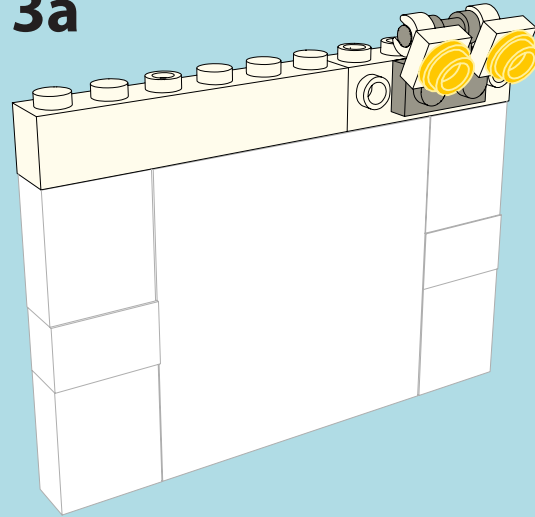

1

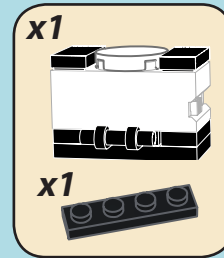
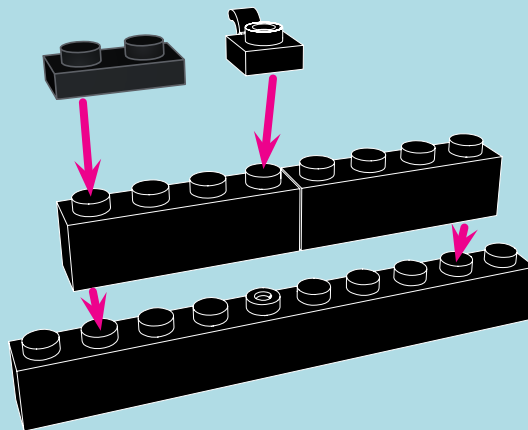

2

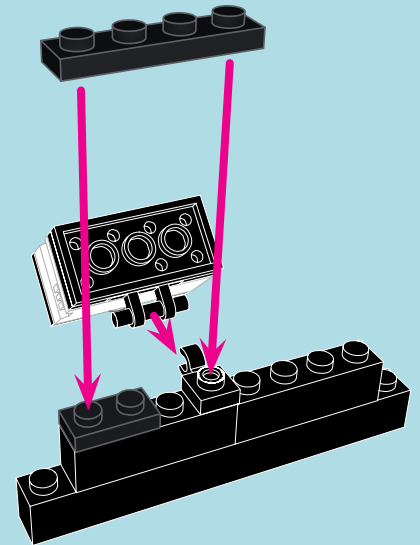

3

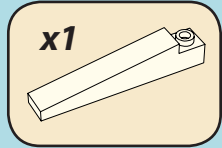
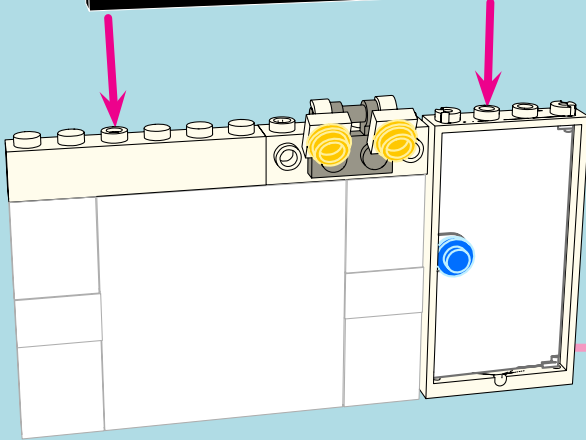
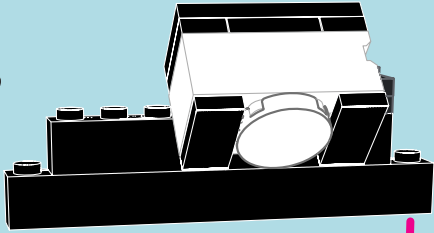

4

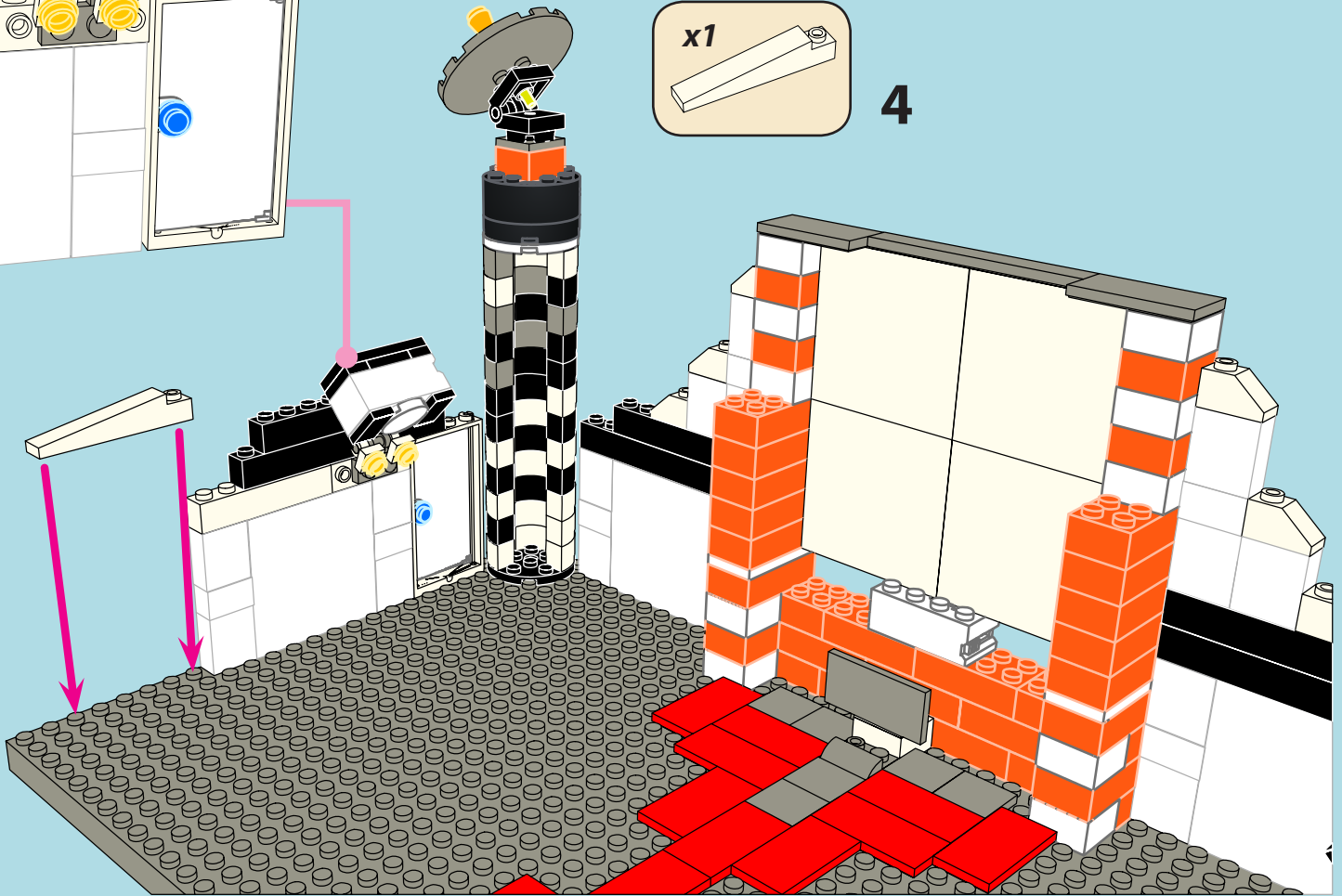

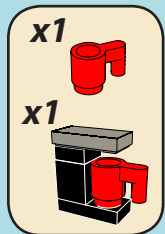

4

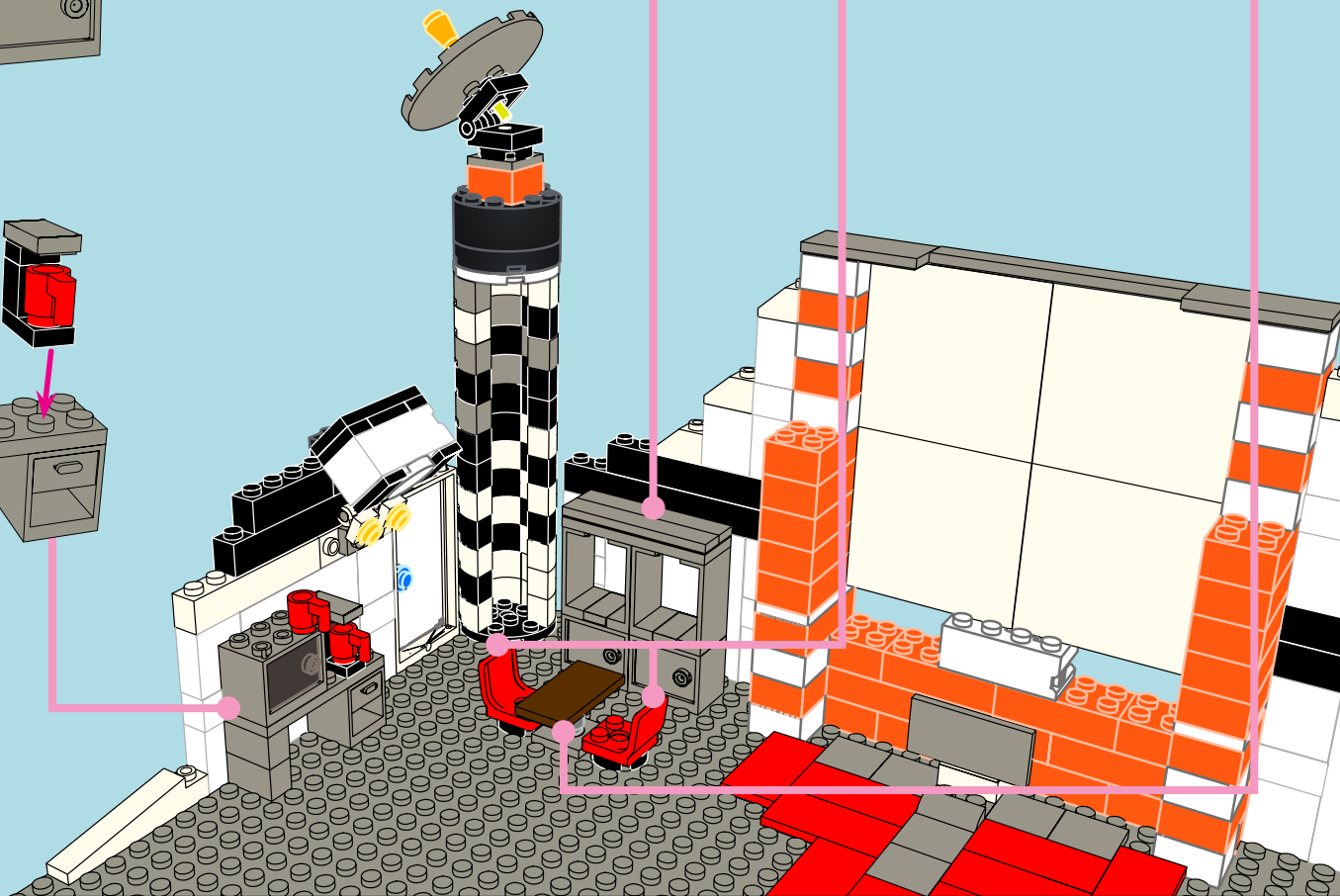
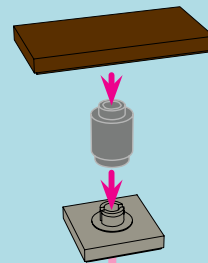
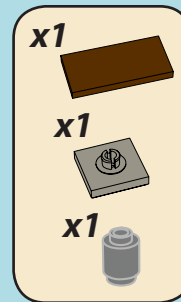
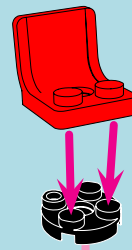
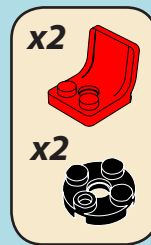
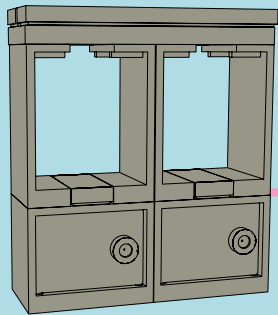
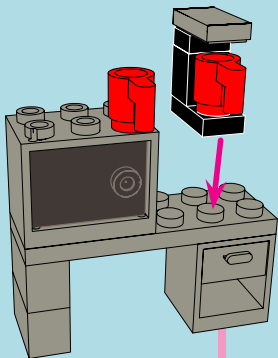

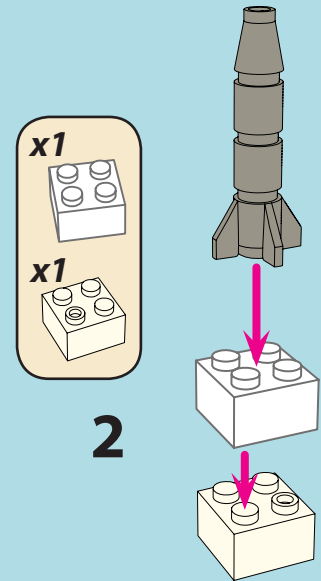
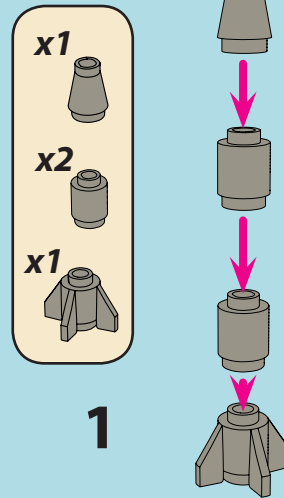
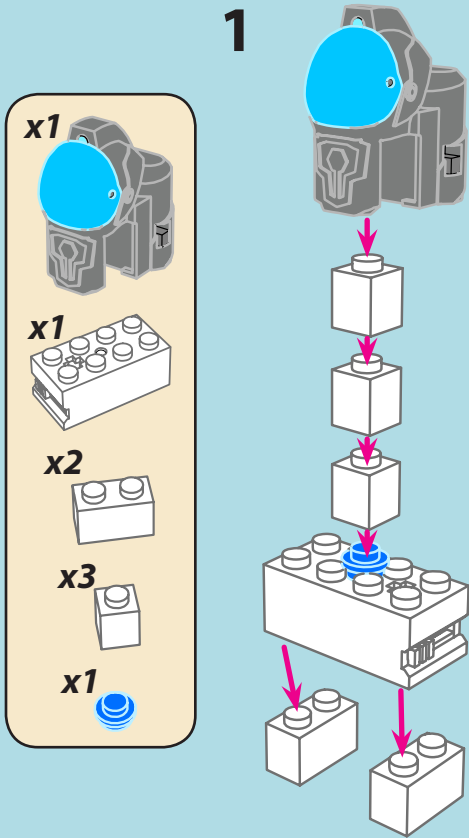
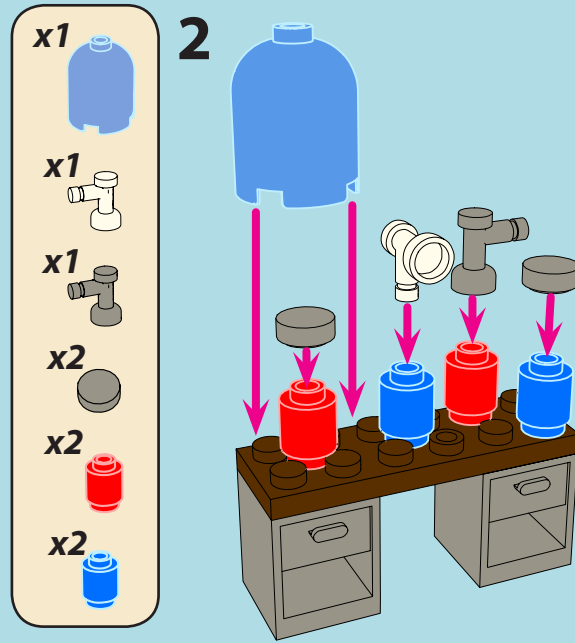
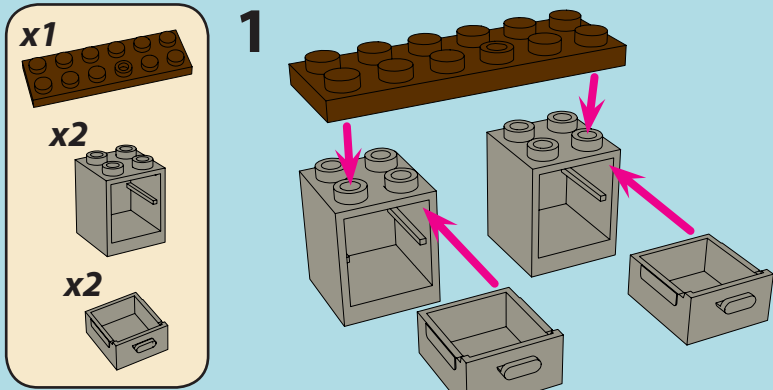

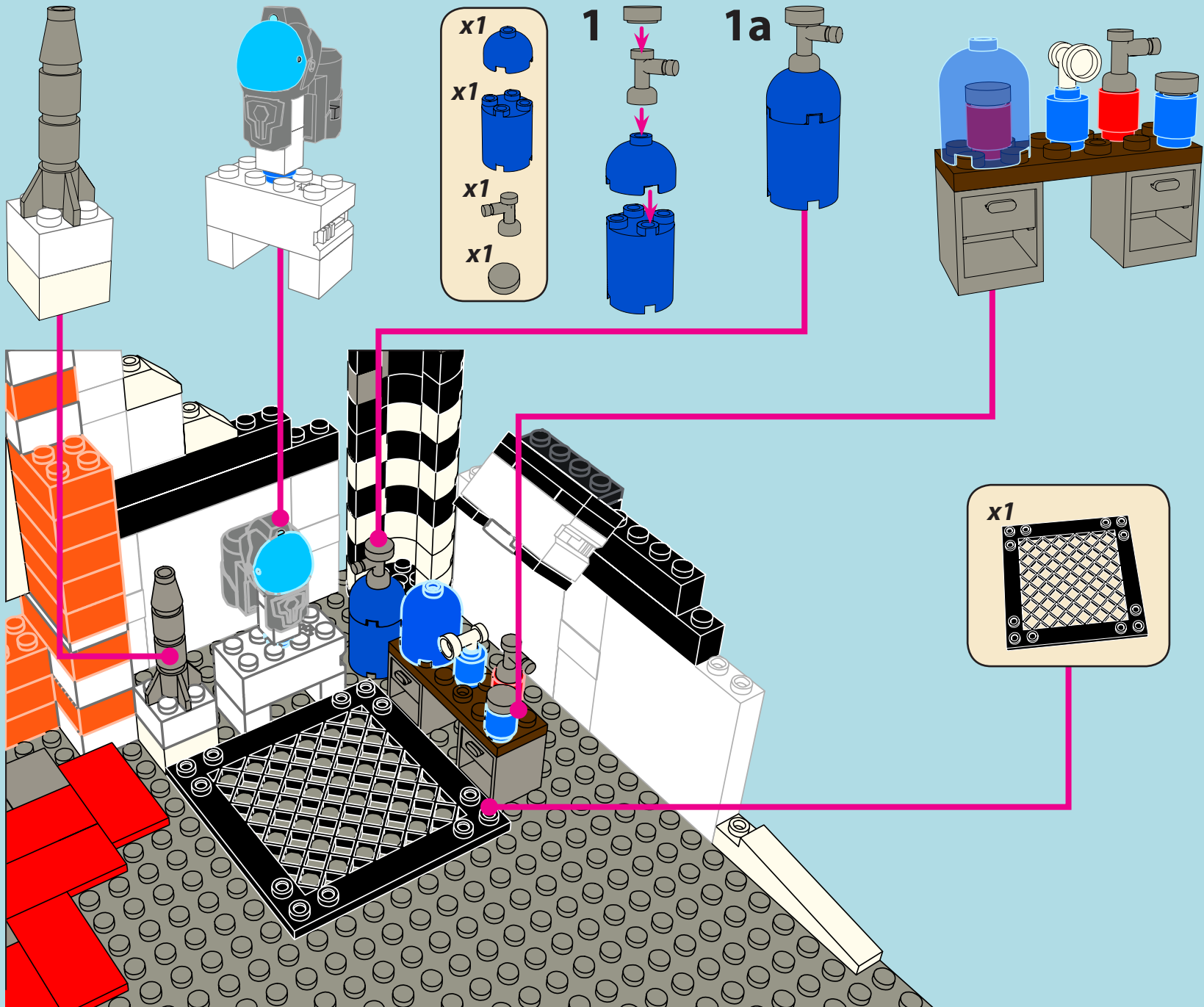

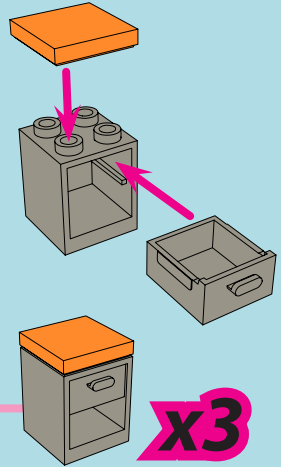
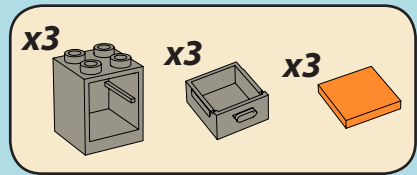
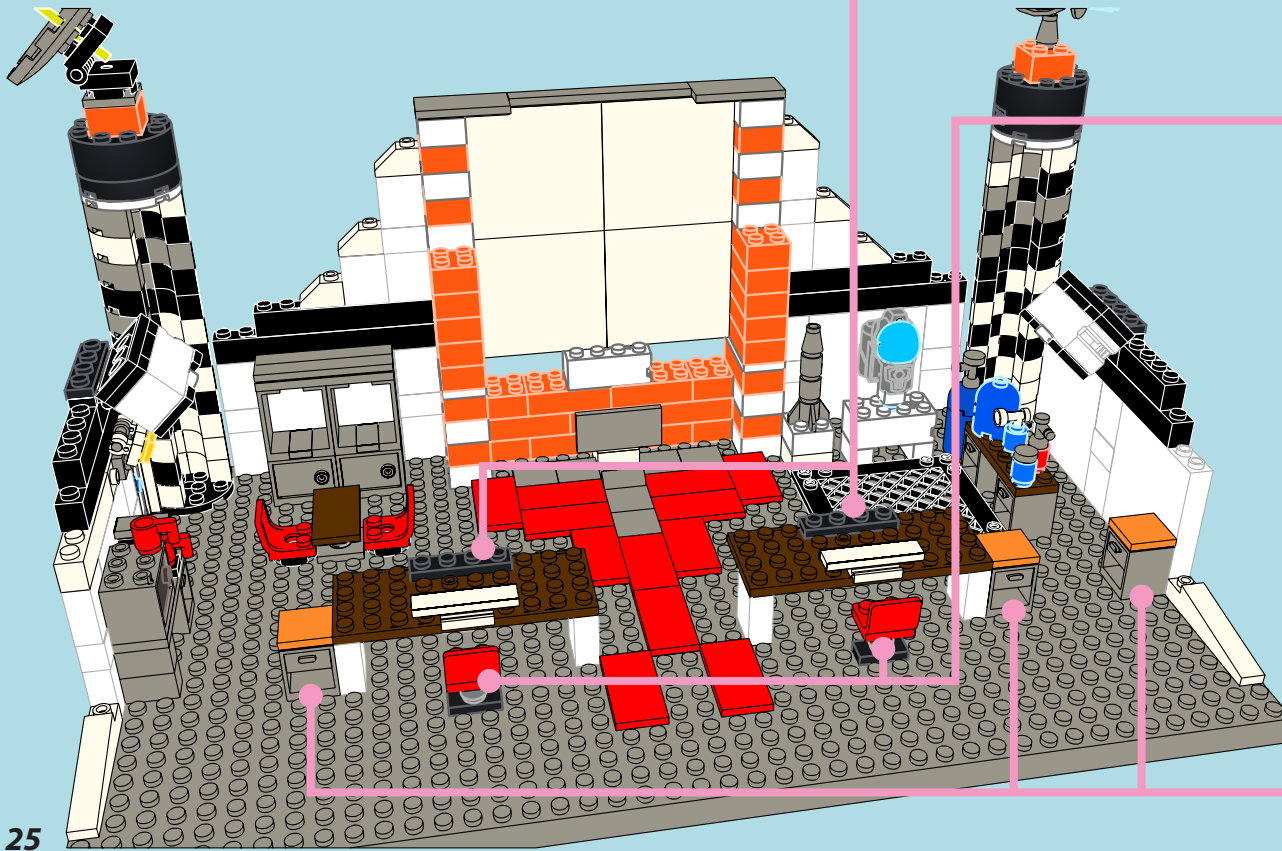
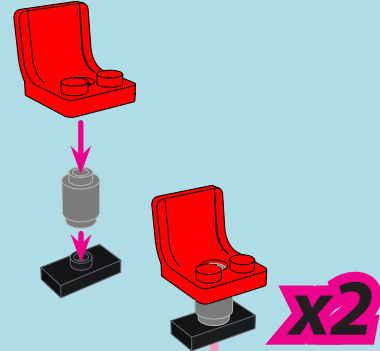
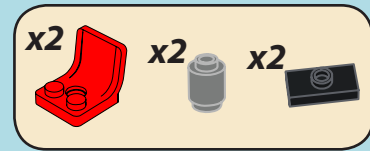
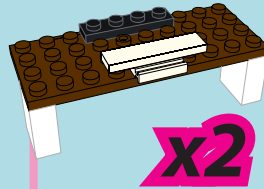
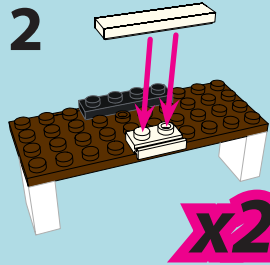
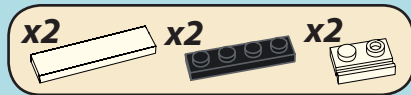
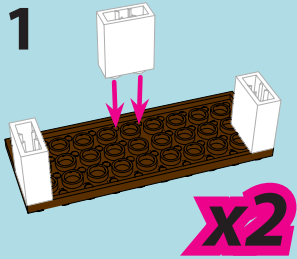

3

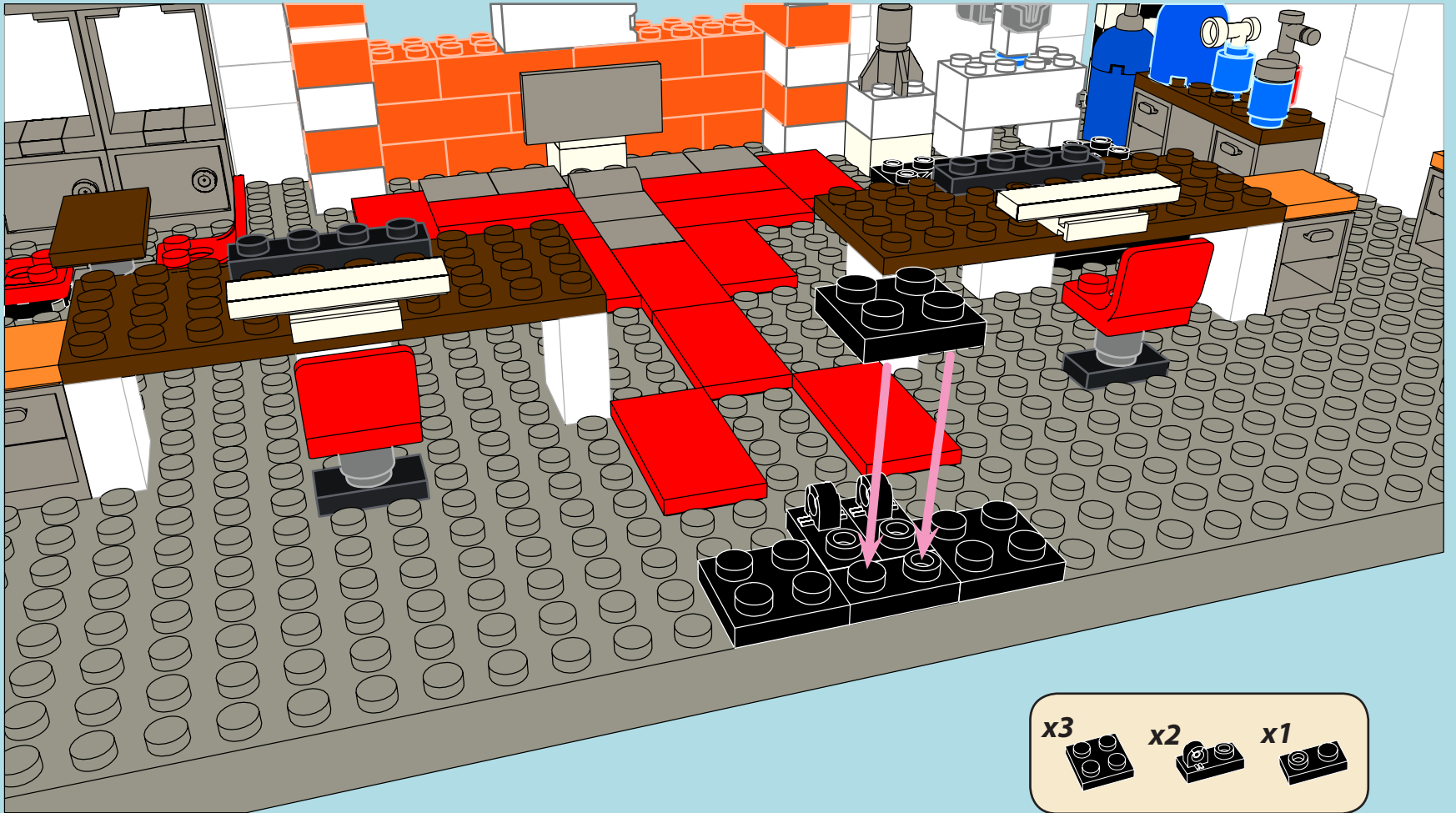

x3 x2 x1

This block contains a parts list for step 3. It lists three 1x4 black Technic bricks with holes (labeled x3), two 1x2 black Technic bricks with holes (labeled x2), and one 1x2 black Technic brick with a hole (labeled x1).

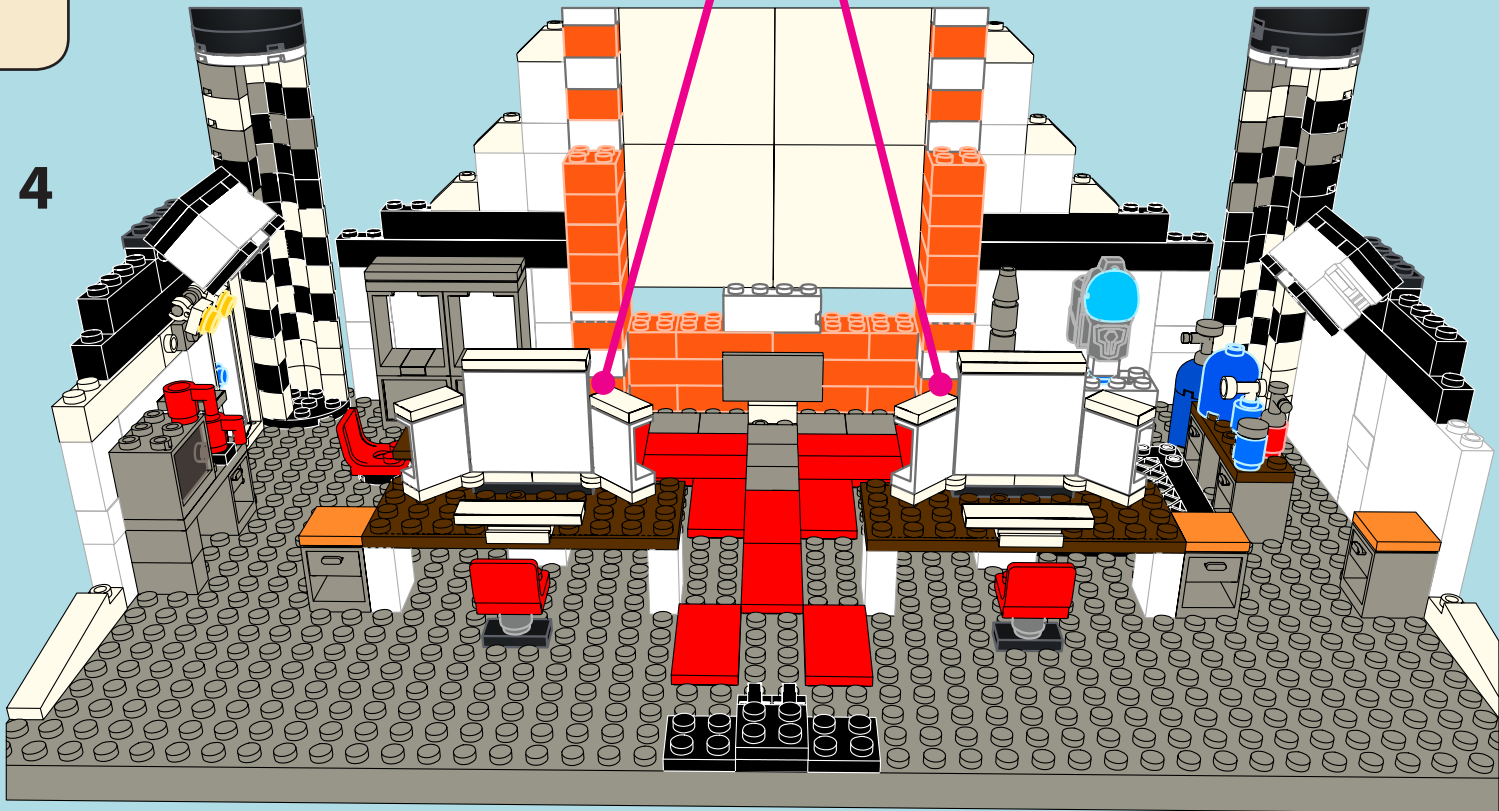
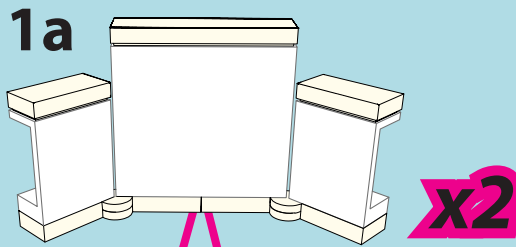
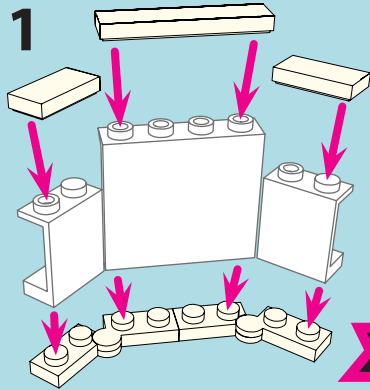
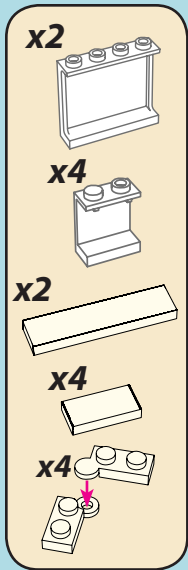

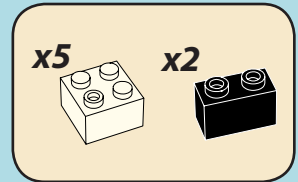
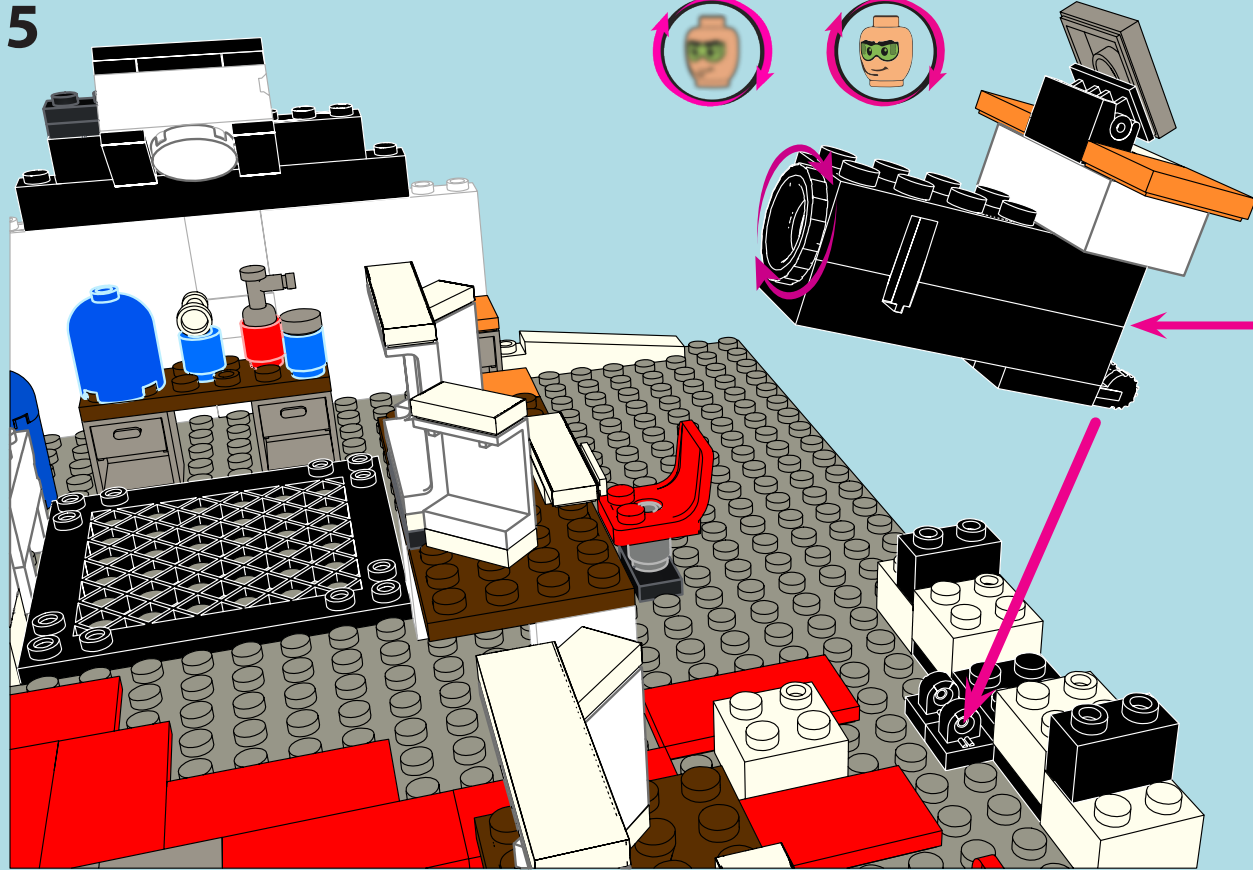
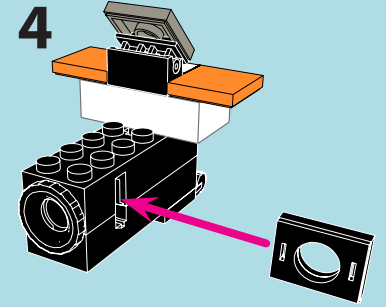
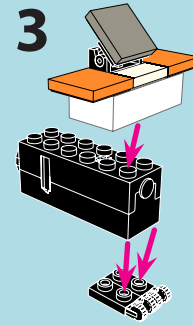
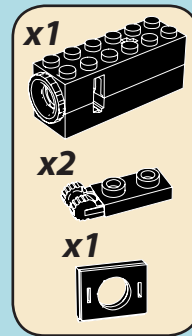
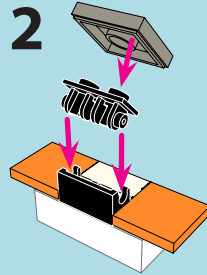
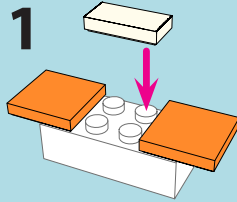
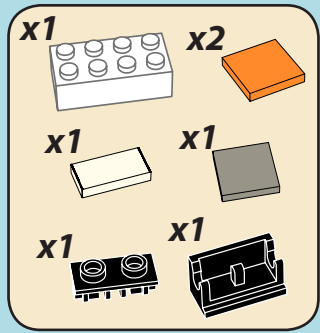

5a

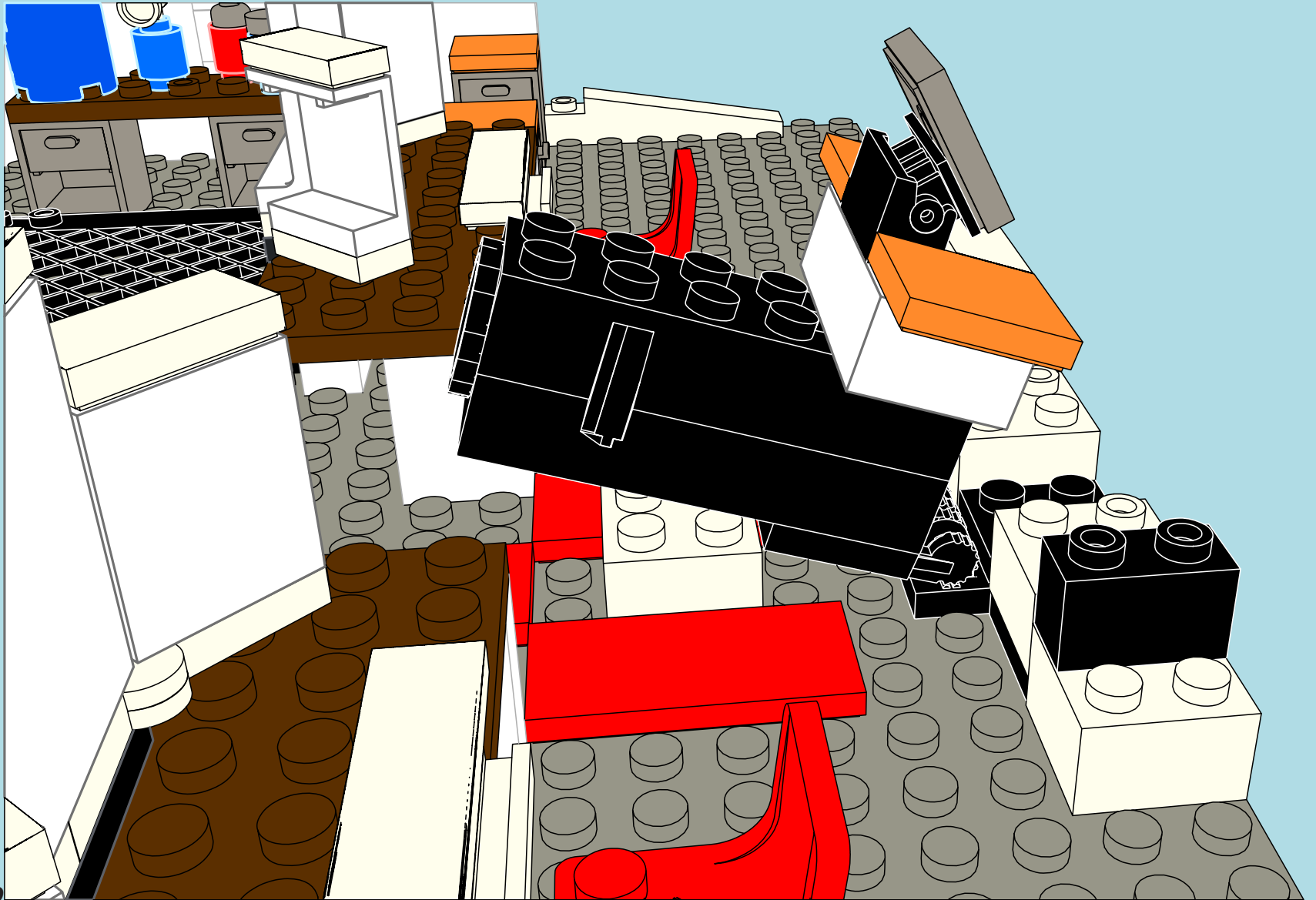

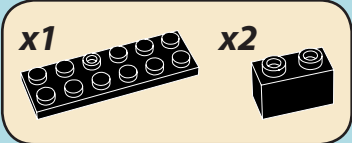
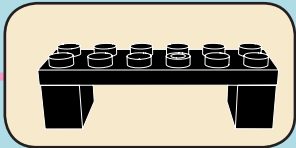
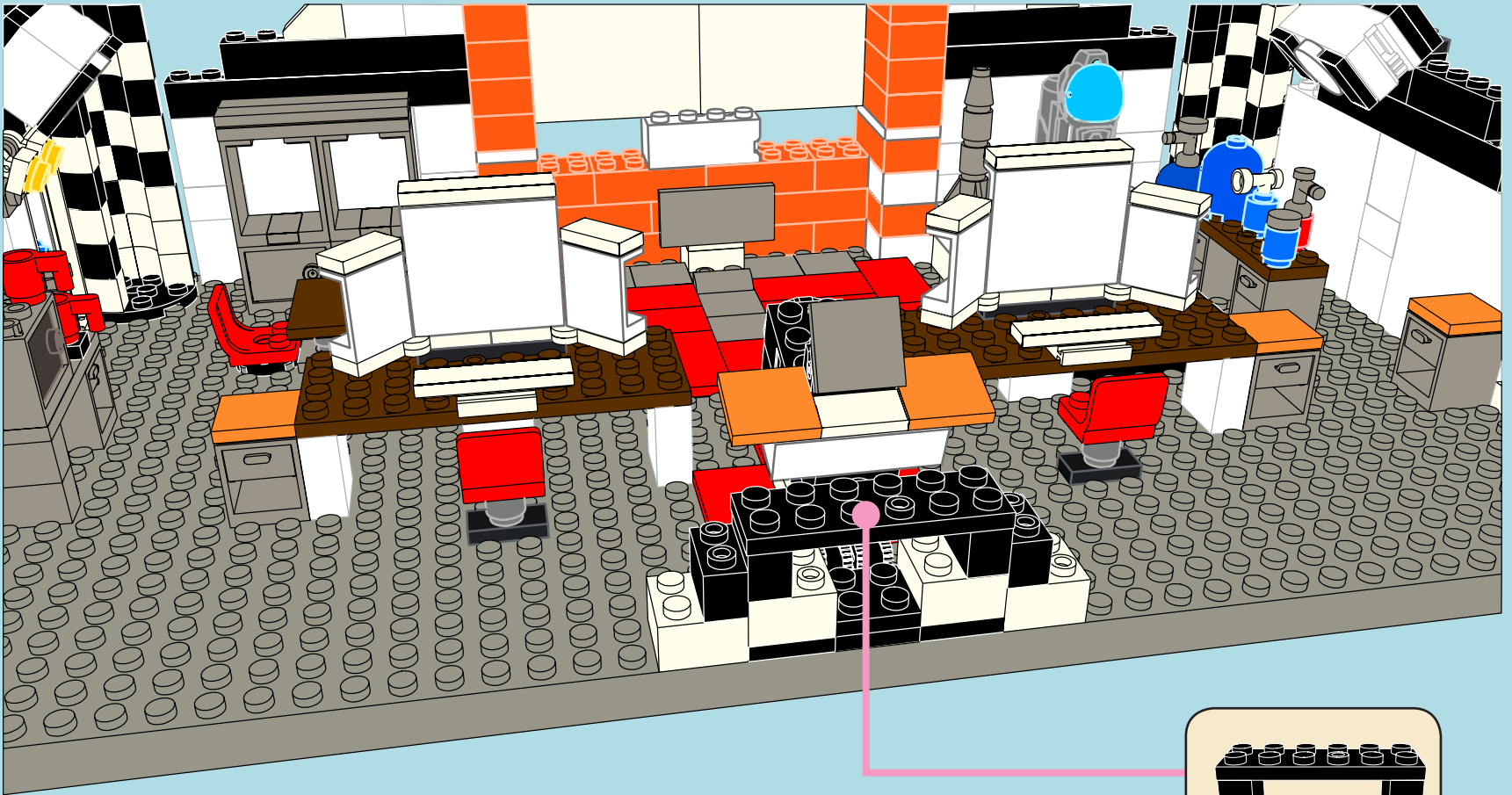

6

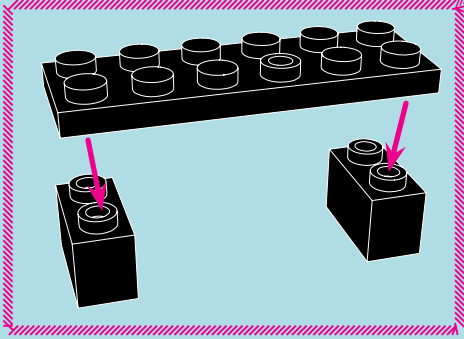



6a

x1

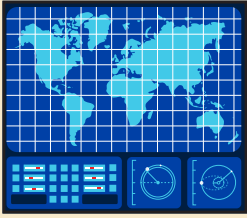

x1

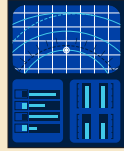

x1

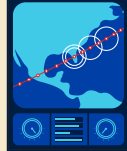

x1

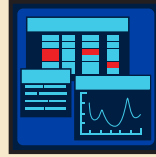

x1



x1



x1



1

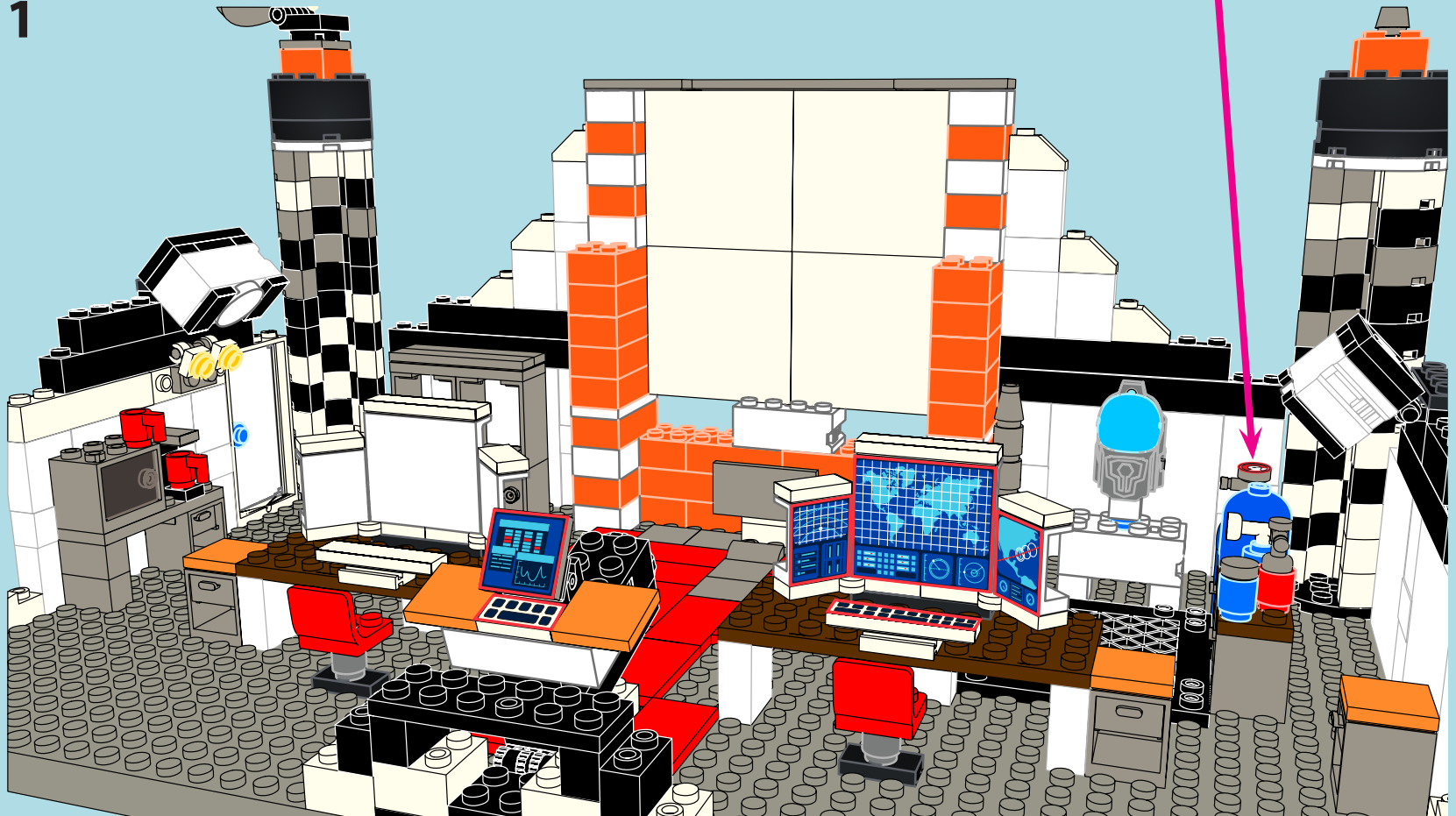

x1

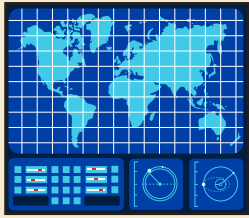

x1

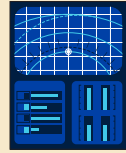

x1

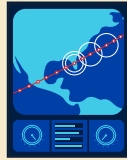

x1



x1



