

Nikon

with **WARRANTY**

DIGITAL CAMERA

D780

User's Manual (with Warranty)

- Read this manual thoroughly before using the camera.
- To ensure proper use of the camera, be sure to read "For Your Safety" (page xv).
- After reading this manual, keep it in a readily accessible place for future reference.

En

Package Contents

Be sure all items listed here were included with your camera.

Camera



BF-1B body cap



DK-31 rubber eyecup
(comes attached to camera)



EN-EL15b rechargeable Li-ion battery with terminal cover

MH-25a battery charger
(comes with either an AC wall adapter or power cable of a type and shape that varies with the country or region of sale)

DK-5 eyepiece cap

UC-E24 USB cable

AN-DC21 strap

Warranty (printed on the back cover of this manual)

User's Manual

- Memory cards are sold separately.
- Purchasers of the lens kit option should confirm that the package also includes a lens (manuals for the lens may also be provided).

D780 Model Name: N1722

✔ The Nikon Download Center

A pdf version of this manual is available from the Nikon Download Center, together with an English-language reference manual with detailed operating instructions, which can be downloaded in pdf format or viewed online in html. Visit the Nikon Download Center to download firmware updates, ViewNX-i and other Nikon computer software, and manuals for other Nikon products including cameras, NIKKOR lenses, and flash units.





<https://downloadcenter.nikonimglib.com/>

About This Manual

■ Symbols

The following symbols and conventions are employed in this manual. Use them to help locate the information you need.

	This icon marks notes, information that should be read before using this product.
	This icon marks tips, additional information you may find helpful when using this product.
	This icon marks references to other sections in this manual.

■ Conventions

- This camera uses SD, SDHC, and SDXC memory cards, referred to throughout this manual as “memory cards”.
- Throughout this manual, battery chargers are referred to as “battery chargers” or “chargers”.
- Throughout this manual, smartphones and tablets are referred to as “smart devices”.
- Throughout this manual, the term “default settings” is used to refer to the settings in effect at shipment. The explanations in this manual assume that default settings are used.

For Your Safety

“For Your Safety” contains important safety instructions. Be sure to read them before using the camera. For more information, see “For Your Safety” ( xv).

■ ■ Nikon User Support

Visit the site below to register your camera and keep up-to-date with the latest product information. You will find answers to frequently asked questions (FAQs) and can contact us for technical assistance.

<https://www.europe-nikon.com/support>

Table of Contents

Package Contents	ii
About This Manual.....	iv
Menu List.....	ix
For Your Safety.....	xv
Notices	xxi
Getting to Know the Camera	1
<hr/>	
Parts of the Camera	1
Camera Body.....	1
The Control Panel.....	7
The Viewfinder	8
The Live View Displays (Photos/Movies).....	11
The MENU Button	13
First Steps	19
<hr/>	
Readying the Camera	19
Attaching the Strap	19
Charging the Battery.....	20
Inserting the Battery.....	22
Attaching a Lens	23
Inserting Memory Cards.....	25
Camera Setup	28
The Battery Level and Number of Exposures Remaining	31
Battery Level.....	31
Memory Card Indicators and Number of Exposures Remaining.....	32

Basic Photography and Playback 34

Taking Photographs (AUTO Mode)	34
Framing Photographs in the Viewfinder (Viewfinder Photography).....	34
Framing Photographs in the Monitor (Live View).....	38
Recording Movies (AUTO Mode)	43
Taking Photos During Filming	48
Playback	49
Viewing Movies	51
Deleting Unwanted Pictures.....	54

Technical Notes 55

Caring for the Camera and Battery: Cautions.....	55
Camera Care	55
Battery Care.....	59
Using the Charger.....	62
Using the Charging AC Adapter	62
Specifications	63
Nikon D780 Digital Camera.....	63

Approved Memory Cards	83
Battery Endurance	84
Trademarks and Licenses	87
Notices	91
Bluetooth and Wi-Fi (Wireless LAN).....	93
Kit Lens Manual	98
<hr/>	
Kit Lenses	98
AF-S NIKKOR 24–120mm f/4G ED VR Lens Manual.....	98
Warranty Terms - Nikon Europe Service Warranty	105
<hr/>	

Menu List

The camera offers the following menus. Some items may not be displayed depending on camera settings or on the type of lens, flash unit, or other accessory attached.

PLAYBACK MENU	PHOTO SHOOTING MENU
Delete	White balance
Playback folder	Set Picture Control
Playback display options	Manage Picture Control
Copy image(s)	Color space
Image review	Active D-Lighting
After delete	Long exposure NR
Rotate tall	High ISO NR
Slide show	Vignette control
Rating	Diffraction compensation
PHOTO SHOOTING MENU	Auto distortion control
Reset photo shooting menu	Flicker reduction
Storage folder	Flash control
File naming	Auto bracketing
Role played by card in Slot 2	Multiple exposure
Image area	HDR (high dynamic range)
Image quality	Interval timer shooting
Image size	Time-lapse movie
NEF (RAW) recording	Focus shift shooting
ISO sensitivity settings	Silent live view photography

MOVIE SHOOTING MENU

Reset movie shooting menu

File naming

Destination

Image area

Frame size/frame rate

Movie quality

Movie file type

ISO sensitivity settings

White balance

Set Picture Control

Manage Picture Control

Active D-Lighting

High ISO NR

Diffraction compensation

Flicker reduction

Electronic VR

Microphone sensitivity

Attenuator

Frequency response

Wind noise reduction

Headphone volume

Timecode

CUSTOM SETTING MENU

Reset custom settings

a Autofocus

a1 AF-C priority selection

a2 AF-S priority selection

a3 Focus tracking with lock-on

a4 3D-tracking face-detection

a5 Auto-area AF face/eye
detection

a6 Focus points used

a7 Store points by orientation

a8 AF activation

a9 Focus point wrap-around

a10 Focus point options

a11 Low-light AF

a12 Manual focus ring in AF
mode

CUSTOM SETTING MENU**b Metering/exposure**

b1	EV steps for exposure cntrl
b2	Easy exposure compensation
b3	Matrix metering
b4	Center-weighted area
b5	Fine-tune optimal exposure

c Timers/AE lock

c1	Shutter-release button AE-L
c2	Standby timer
c3	Self-timer
c4	Monitor off delay

CUSTOM SETTING MENU**d Shooting/display**



d1	CL mode shooting speed
d2	Max. continuous release
d3	Sync. release mode options
d4	Exposure delay mode
d5	Electronic front-curtain shutter
d6	Extended shutter speeds (M)
d7	File number sequence
d8	Save original (EFFECTS)
d9	Exposure preview (Lv)
d10	Framing grid display
d11	Peaking highlights
d12	LCD illumination
d13	Live view in continuous mode
d14	Optical VR

CUSTOM SETTING MENU

e Bracketing/flash

e1	Flash sync speed
e2	Flash shutter speed
e3	Exposure comp. for flash
e4	Auto  ISO sensitivity control
e5	Modeling flash
e6	Bracketing order

f Controls

f1	Customize  menu
f2	Customize  menu (Lv)
f3	Custom controls
f4	OK button
f5	Customize command dials
f6	Release button to use dial
f7	Reverse indicators
f8	 switch

CUSTOM SETTING MENU

g Movie

g1	Customize  menu
g2	Custom controls
g3	AF speed
g4	AF tracking sensitivity
g5	Highlight display

SETUP MENU

Format memory card

Save user settings

Reset user settings

Language

Time zone and date

Monitor brightness

Monitor color balance

Virtual horizon

Information display

SETUP MENU
AF fine-tuning options
Non-CPU lens data
Clean image sensor
Lock mirror up for cleaning
Image Dust Off ref photo
Pixel mapping
Image comment
Copyright information
Beep options
Touch controls
HDMI
Location data
Wireless remote (WR) options
Assign remote (WR) Fn button

SETUP MENU
Airplane mode
Connect to smart device
Connect to PC
Wireless transmitter (WT-7)
Conformity marking
Battery info
Slot empty release lock
Save/load menu settings
Reset all settings
Firmware version

RETOUCH MENU

NEF (RAW) processing

Trim

Resize

D-Lighting

Quick retouch

Red-eye correction

Straighten

Distortion control

Perspective control

Monochrome

Image overlay

Trim movie

MY MENU

Add items

Remove items

Rank items

Choose tab

For Your Safety

To prevent damage to property or injury to yourself or to others, read “For Your Safety” in its entirety before using this product.

Keep these safety instructions where all those who use this product will read them.

 **DANGER:** Failure to observe the precautions marked with this icon carries a high risk of death or severe injury.

 **WARNING:** Failure to observe the precautions marked with this icon could result in death or severe injury.

 **CAUTION:** Failure to observe the precautions marked with this icon could result in injury or property damage.

WARNING

Do not use while walking or operating a vehicle.

Failure to observe this precaution could result in accidents or other injury.

Do not disassemble or modify this product. Do not touch internal parts that become exposed as the result of a fall or other accident.

Failure to observe these precautions could result in electric shock or other injury.

Should you notice any abnormalities such as the product producing smoke, heat, or unusual odors, immediately disconnect the battery or power source.

Continued operation could result in fire, burns or other injury.

Keep dry. Do not handle with wet hands. Do not handle the plug with wet hands.

Failure to observe these precautions could result in fire or electric shock.

Do not let your skin remain in prolonged contact with this product while it is on or plugged in.

Failure to observe this precaution could result in low-temperature burns.

Do not use this product in the presence of flammable dust or gas such as propane, gasoline or aerosols.

Failure to observe this precaution could result in explosion or fire.

Do not directly view the sun or other bright light source through the lens or camera.

Failure to observe this precaution could result in visual impairment.

Do not aim the flash or AF-assist illuminator at the operator of a motor vehicle

Failure to observe this precaution could result in accidents.

Keep this product out of reach of children.

Failure to observe this precaution could result in injury or product malfunction. In addition, note that small parts constitute a choking hazard. Should a child swallow any part of this product, seek immediate medical attention.

Do not entangle, wrap or twist the straps around your neck.

Failure to observe this precaution could result in accidents.

Do not use batteries, chargers, or AC adapters not specifically designated for use with this product. When using batteries, chargers, and AC adapters designated for use with this product, do not:

- **Damage, modify, forcibly tug or bend the cords or cables, place them under heavy objects, or expose them to heat or flame.**
- **Use travel converters or adapters designed to convert from one voltage to another or with DC-to-AC inverters.**

Failure to observe these precautions could result in fire or electric shock.

Do not handle the plug when charging the product or using the AC adapter during thunderstorms.

Failure to observe this precaution could result in electric shock.

Do not handle with bare hands in locations exposed to extremely high or low temperatures.

Failure to observe this precaution could result in burns, or frostbite.

CAUTION

Do not leave the lens pointed at the sun or other strong light sources.

Light focused by the lens could cause fire or damage to product's internal parts. When shooting backlit subjects, keep the sun well out of the frame. Sunlight focused into the camera when the sun is close to the frame could cause fire.

Turn this product off when its use is prohibited. Disable wireless features when the use of wireless equipment is prohibited.

The radio-frequency emissions produced by this product could interfere with equipment onboard aircraft or in hospitals or other medical facilities.

Remove the battery and disconnect the AC adapter if this product will not be used for an extended period.

Failure to observe this precaution could result in fire or product malfunction.

Do not fire the flash in contact with or in close proximity to the skin or objects.

Failure to observe this precaution could result in burns or fire.

Do not leave the product where it will be exposed to extremely high temperatures, for an extended period such as in an enclosed automobile or in direct sunlight.

Failure to observe this precaution could result in fire or product malfunction.

Do not look directly at the AF-assist illuminator.

Failure to observe this precaution could have adverse effects on vision.

Do not transport cameras or lenses with tripods or similar accessories attached.

Failure to observe this precaution could result in injury or product malfunction.

DANGER (Batteries)

Do not mishandle batteries.

Failure to observe the following precautions could result in the batteries leaking, overheating, rupturing, or catching fire:

- Use only rechargeable batteries approved for use in this product.
- Do not expose batteries to flame or excessive heat.
- Do not disassemble.
- Do not short-circuit the terminals by touching them to necklaces, hairpins, or other metal objects.
- Do not expose batteries or the products in which they are inserted to powerful physical shocks.
- Do not step on batteries, pierce them with nails, or strike them with hammers.

Charge only as indicated.

Failure to observe this precaution could result in the batteries leaking, overheating, rupturing, or catching fire.

If battery liquid comes into contact with the eyes, rinse with plenty of clean water and seek immediate medical attention.

Delaying action could result in eye injuries.

WARNING (Batteries)

Keep batteries out of reach of children.

Should a child swallow a battery, seek immediate medical attention.

Keep batteries out of reach of household pets and other animals.

The batteries could leak, overheat, rupture, or catch fire if bitten, chewed, or otherwise damaged by animals.

Do not immerse batteries in water or expose to rain.

Failure to observe this precaution could result in fire or product malfunction. Immediately dry the product with a towel or similar object should it become wet.

Discontinue use immediately should you notice any changes in the batteries, such as discoloration or deformation. Cease charging EN-EL15b rechargeable batteries if they do not charge in the specified period of time.

Failure to observe these precautions could result in the batteries leaking, overheating, rupturing, or catching fire.

When batteries are no longer needed, insulate the terminals with tape.

Overheating, rupture, or fire may result should metal objects come into contact with the terminals.

If battery liquid comes into contact with a person's skin or clothing, immediately rinse the affected area with plenty of clean water.

Failure to observe this precaution could result in skin irritation.

Notices

- No part of the manuals included with this product may be reproduced, transmitted, transcribed, stored in a retrieval system, or translated into any language in any form, by any means, without Nikon's prior written permission.
- Nikon reserves the right to change the appearance and specifications of the hardware and software described in these manuals at any time and without prior notice.
- Nikon will not be held liable for any damages resulting from the use of this product.
- While every effort has been made to ensure that the information in these manuals is accurate and complete, we would appreciate it were you to bring any errors or omissions to the attention of the Nikon representative in your area (address provided separately).

● **Notice Concerning Prohibition of Copying or Reproduction**

Note that simply being in possession of material that has been digitally copied or reproduced by means of a scanner, digital camera, or other device may be punishable by law.

• **Items prohibited by law from being copied or reproduced**

Do not copy or reproduce paper money, coins, securities, government bonds, or local government bonds, even if such copies or reproductions are stamped "Sample."

The copying or reproduction of paper money, coins, or securities which are circulated in a foreign country is prohibited.

Unless the prior permission of the government has been obtained, the copying or reproduction of unused postage stamps or post cards issued by the government is prohibited.

The copying or reproduction of stamps issued by the government and of certified documents stipulated by law is prohibited.

• **Cautions on certain copies and reproductions**

The government has issued cautions on copies or reproductions of securities issued by private companies (shares, bills, checks, gift certificates, etc.), commuter passes, or coupon tickets, except when a minimum of necessary copies are to be provided for business use by a company. Also, do not copy or reproduce passports issued by the government, licenses issued by public agencies and private groups, ID cards, and tickets, such as passes and meal coupons.

• **Comply with copyright notices**

Under copyright law, photographs or recordings of copyrighted works made with the camera cannot be used without the permission of the copyright holder. Exceptions apply to personal use, but note that even personal use may be restricted in the case of photographs or recordings of exhibits or live performances.

● Use Only Nikon Brand Electronic Accessories

Nikon cameras are designed to the highest standards and include complex electronic circuitry. Only Nikon brand electronic accessories (including lenses, chargers, batteries, AC adapters, and flash accessories) certified by Nikon specifically for use with this Nikon digital camera are engineered and proven to operate within the operational and safety requirements of this electronic circuitry.

The use of non-Nikon electronic accessories could damage the camera and may void your Nikon warranty. The use of third-party rechargeable Li-ion batteries not bearing the Nikon holographic seal shown at right could interfere with normal operation of the camera or result in the batteries overheating, igniting, rupturing, or leaking.



For more information about Nikon brand accessories, contact a local authorized Nikon dealer.

✔ Before Taking Important Pictures

Before taking pictures on important occasions (such as at weddings or before taking the camera on a trip), take a test shot to ensure that the camera is functioning normally. Nikon will not be held liable for damages or lost profits that may result from product malfunction.

✔ Life-Long Learning

As part of Nikon's "Life-Long Learning" commitment to ongoing product support and education, continually-updated information is available online at the following sites:

- **For users in the U.S.A.:** <https://www.nikonusa.com/>
- **For users in Europe and Africa:**
<https://www.europe-nikon.com/support/>
- **For users in Asia, Oceania, and the Middle East:**
<https://www.nikon-asia.com/>

Visit these sites to keep up-to-date with the latest product information, tips, answers to frequently-asked questions (FAQs), and general advice on digital imaging and photography. Additional information may be available from the Nikon representative in your area. See the following URL for contact information: <https://imaging.nikon.com/>



Getting to Know the Camera

Parts of the Camera

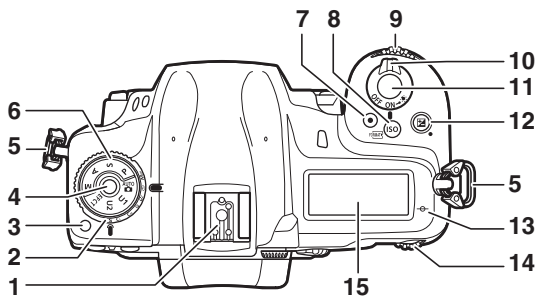
Camera Body



- 1 Accessory shoe (for optional flash unit)
- 2 Release mode dial
- 3 Release mode dial lock release
- 4 Mode dial lock release
- 5 Eyelet for camera strap (☞ 19)
- 6 Mode dial
- 7 Movie-record button (☞ 43)

- 8 **ISO** (FORMATS) button
- 9 Sub-command dial
- 10 Power switch
- 11 Shutter-release button (☞ 34)
- 12  button
- 13  (focal plane mark)
- 14 Main command dial
- 15 Control panel (☞ 7)

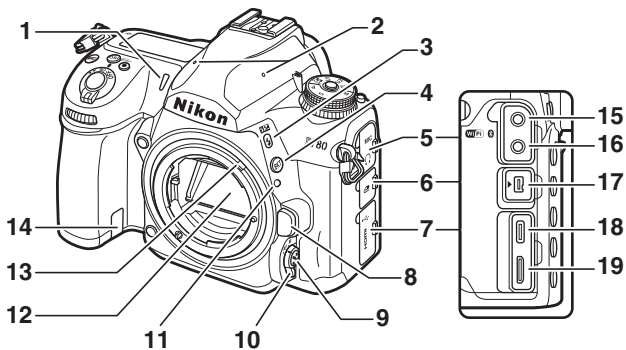

- | | | | |
|---|---------------------------------------|----|------------------------------------|
| 1 | Self-timer lamp | 10 | Focus-mode selector |
| 2 | Stereo microphone (☞ 43) | 11 | Lens mounting mark (☞ 23) |
| 3 | ⚡ (AE-L/AF-ON) button | 12 | Mirror |
| 4 | BKT button | 13 | Meter coupling lever |
| 5 | Audio connector cover | 14 | Power connector cover |
| 6 | Accessory terminal connector cover | 15 | Connector for external microphones |
| 7 | Cover for USB and HDMI connectors | 16 | Headphone connector |
| 8 | Lens release button (☞ 24) | 17 | Accessory terminal |
| 9 | AF-mode button | 18 | USB connector |
| | | 19 | HDMI connector |

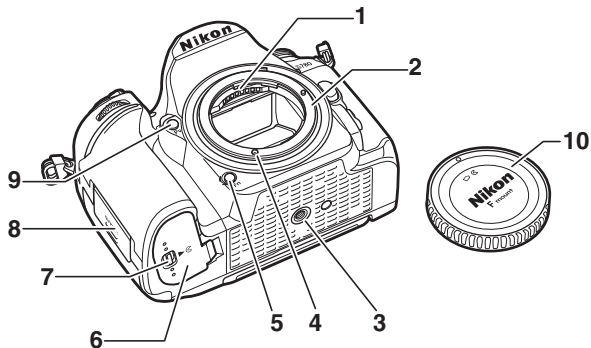

1 CPU contacts

2 Lens mount (☞ 23)

3 Tripod socket

4 AF coupling

5 **Fn** button

6 Battery-chamber cover

7 Battery-chamber cover latch

8 Memory card slot cover (☞ 25)

9 **P/v** button

10 Body cap (☞ 23)

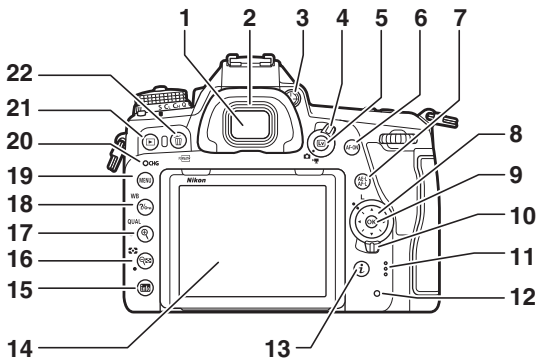

- | | | | |
|----|-----------------------------------|----|------------------------------------|
| 1 | Viewfinder eyepiece (☞ 10) | 12 | Memory card access lamp (☞ 25, 34) |
| 2 | Rubber eyecup | 13 | i button |
| 3 | Diopter adjustment control (☞ 10) | 14 | Tilting monitor (☞ 5) |
| 4 | Live view selector (☞ 38, 43) | 15 | info button |
| 5 | L button (☞ 38, 43) | 16 | Q (Q) button |
| 6 | AF-ON button | 17 | QUAL (QUAL) button |
| 7 | AE-L/AF-ON button | 18 | ?/WB (WB) button |
| 8 | Multi selector (☞ 14) | 19 | MENU button (☞ 13) |
| 9 | OK button (☞ 14) | 20 | Charge lamp |
| 10 | Focus selector lock | 21 | Play button (☞ 49) |
| 11 | Speaker | 22 | Format (FORMAT) button (☞ 54) |

✔ The Connector Covers

Be sure to close the covers when the connectors are not in use. Foreign matter in the connectors could cause malfunction.

✔ The Speaker

Close proximity to the speaker could corrupt data stored on magnetic stripe cards or other such magnetic storage devices. Keep magnetic storage devices away from the speaker.

✔ The Monitor

The angle of the monitor can be adjusted as shown.

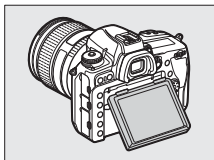
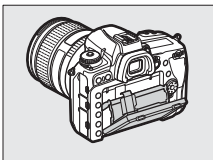

✔ The Serial Number

The product serial number is located behind the monitor.

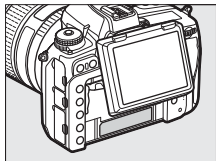

✔ Tilting the Monitor

- Rotate the monitor gently within the limits of the hinges. Do not use force; failure to observe this precaution could damage the camera or monitor.
- Do not touch the area to the rear of the monitor. Be particularly careful not to touch the area shown. Failure to observe this precaution could cause product malfunction.
- Do not allow liquid to contact the monitor's inner surface. Failure to observe this precaution could cause product malfunction.
- We recommend that you keep the monitor in the storage position when not using it to frame photographs.
- Do not lift or carry the camera by the monitor. Failure to observe this precaution could damage the camera.
- When the camera is mounted on a tripod, care should be taken to ensure that the monitor does not contact the tripod.

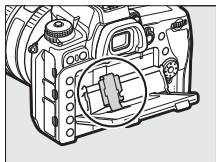

The Control Panel

The following indicators appear in the control panel at default settings.

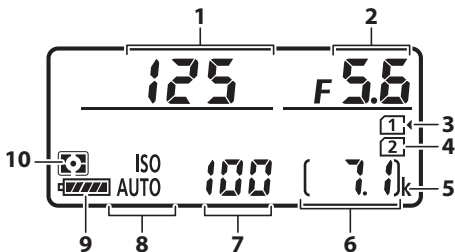

1 Shutter speed

2 Aperture

3 Memory card icon (Slot 1;
32)

4 Memory card icon (Slot 2;
32)

5 "k" (appears when memory
remains for over 1000
exposures; 32)

6 Number of exposures
remaining (32)

7 ISO sensitivity

8 ISO sensitivity indicator
Auto ISO sensitivity indicator

9 Battery indicator (31)

10 Metering

☑ Camera Off Display

If the camera is turned off with a battery inserted, the control panel will display a memory card icon and the number of exposures remaining. In rare instances, some memory cards may not display the memory card icon and number of exposures remaining when the camera is off, even if a battery is inserted. This information will be displayed when the camera is turned on.

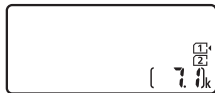

The Viewfinder

The following indicators appear in the viewfinder at default settings.

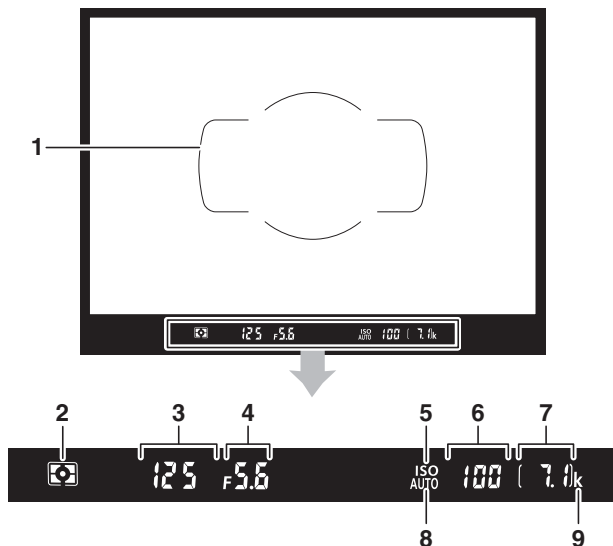

- 1 AF area brackets (34)
- 2 Metering
- 3 Shutter speed
- 4 Aperture
- 5 ISO sensitivity indicator
- 6 ISO sensitivity

- 7 Number of exposures remaining (32)
- 8 Auto ISO sensitivity indicator
- 9 "k" (appears when memory remains for over 1000 exposures; 32)

✔ The Viewfinder

When the battery is exhausted or no battery is inserted, the display in the viewfinder will dim. The display will return to normal when a charged battery is inserted.

✔ Temperature Extremes

The brightness of the control panel and viewfinder displays varies with temperature, and response times may drop when the temperature is low; the displays will return to normal at room temperature.

✔ Cover the Viewfinder

- When taking photos without your eye to the viewfinder, attach the supplied eyepiece cap to prevent light entering via the viewfinder appearing in photographs or interfering with exposure.
- Remove the rubber eyecup (①) and insert the supplied eyepiece cap as shown (②). Hold the camera firmly when removing the rubber eyepiece cup.

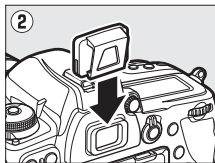
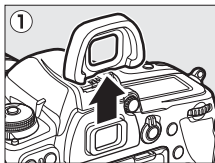

▣ The Diopter Adjustment Control

With your eye to the viewfinder, rotate the diopter control until display in the viewfinder is in sharp focus.

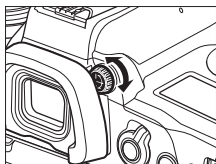

Viewfinder not in focus

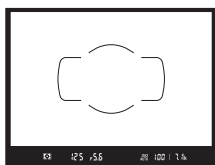

Viewfinder in focus

The Live View Displays (Photos/Movies)

Press the **[Lv]** button to display the view through the lens in the monitor. Rotate the live view selector to **[📷]** to take photographs or to **[🎥]** to record movies.

■ Live View Photography

The following indicators appear in the monitor at default settings.

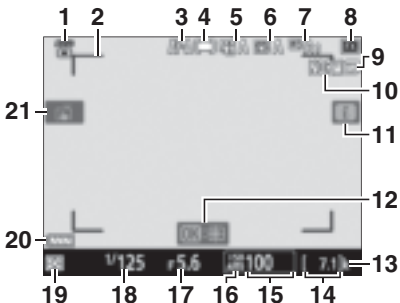

1 Shooting mode

2 AF-area brackets (📐 38)

3 Autofocus mode

4 AF-area mode

5 Active D-Lighting

6 Set Picture Control

7 White balance



8 Image area

9 Image size

10 Image quality





11 **z** icon

12 Subject tracking AF

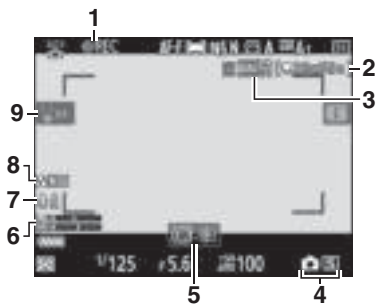
13	"k" (appears when memory remains for over 1000 exposures;  32)	17	Aperture
14	Number of exposures remaining ( 32)	18	Shutter speed
15	ISO sensitivity	19	Metering
16	ISO sensitivity indicator Auto ISO sensitivity indicator	20	Battery indicator ( 31)
		21	Touch shooting

■ Movies



1	Recording indicator ( 43) "No movie" indicator	5	Subject tracking AF
2	Time remaining ( 43)	6	Sound level ( 43)
3	Frame size and rate/image quality	7	Microphone sensitivity
4	Release mode (still photography)	8	Frequency response
		9	AF-area brackets ( 43)

The MENU Button

Press the MENU button to view the menus.

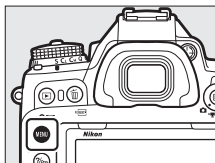

- 1 PLAYBACK MENU
- 2 PHOTO SHOOTING MENU
- 3 MOVIE SHOOTING MENU
- 4 CUSTOM SETTING MENU
- 5 SETUP MENU
- 6 RETOUCH MENU
- 7 MY MENU/
 RECENT SETTINGS *
- 8 Help icon
- 9 Current settings

* You can choose the menu displayed. The default is **[MY MENU]**.

■ Using the Menu

You can navigate the menus using the multi selector and **OK** button.

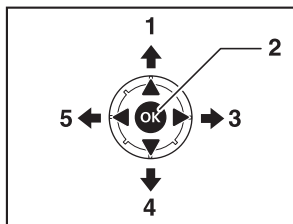

- 1 Move cursor up
- 2 Select highlighted item
- 3 Display sub-menu, select highlighted item, or move cursor right
- 4 Move cursor down
- 5 Cancel and return to previous menu, or move cursor left

1 Highlight the icon for the current menu.

Press **OK** to highlight the icon for the current menu.



2 Select a menu.

Press **Up** or **Down** to select the desired menu.



3 Position the cursor in the selected menu.

Press  to position the cursor in the selected menu.



4 Highlight a menu item.

Press  or  to highlight a menu item.



5 Display options.

Press  to display options for the selected menu item.



6 Highlight an option.

Press  or  to highlight an option.



7 Select the highlighted option.

- Press .
- To exit without making a selection, press the MENU button.
- To exit the menus and return to shooting mode, press the shutter-release button halfway.



✔ Grayed-Out Items

Some items and menu options may be unavailable depending on the mode and camera state. Unavailable items are displayed in gray and cannot be selected.



✔ Text Entry

A keyboard is displayed when text entry is required.





- 1 Text display area
- 2 Keyboard area
- 3 Keyboard selection

- Enter characters at the current cursor position by highlighting them with the multi selector and pressing **OK**.
 - To move the cursor left or right in the text display area, rotate the main command dial.
 - To cycle through the upper- and lower-case and symbol keyboards, highlight the keyboard selection icon and press **OK**. The keyboard selection icon may not be available in some cases.
 - If a character is entered when the text display area is full, the rightmost character will be deleted.
 - To delete the character under the cursor, press the **DELETE (FORMAT)** button.
 - To complete entry, press **Q (QUAL)**.
 - To exit without completing text entry, press **MENU**.
-

▣ The ? (Help) Icon

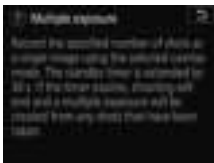
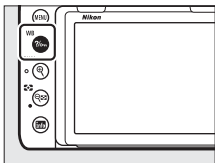
- Where available, a description of the currently-selected item can be viewed by pressing the ?/WB (WB) button.



- Press  or  to scroll.
- Press ?/WB (WB) again to return to the menus.

▣ Touch Controls

You can also navigate the menus using touch controls.

First Steps

Readying the Camera

Attaching the Strap

To attach a strap (whether the supplied strap or one that has been purchased separately):

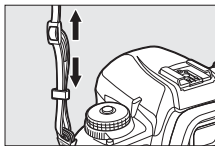
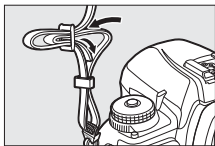
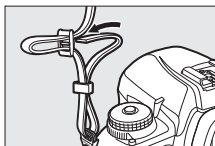
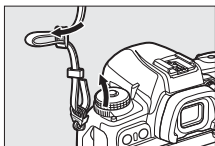

Charging the Battery

Charge the supplied EN-EL15b battery in the supplied MH-25a battery charger before use. Insert the battery and plug the charger in (depending on the country or region, the charger comes with either an AC wall adapter or a power cable).

- **AC wall adapter:** After inserting the AC wall adapter into the charger AC inlet (①), slide the AC wall adapter latch as shown (②) and rotate the adapter 90° to fix it in place (③).

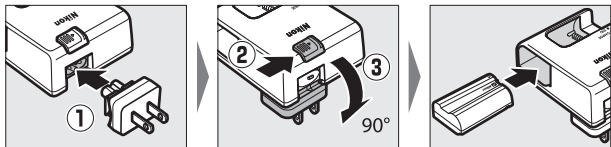

- **Power cable:** After connecting the power cable with the plug in the orientation shown, insert the battery and plug the cable in.

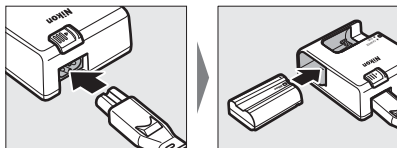

- An exhausted battery will fully charge in about two hours and 35 minutes.

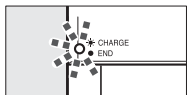

Battery charging (flashes)

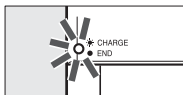

Charging complete (steady)

✔ The Battery and Charger

Read and follow the warnings and cautions in “For Your Safety” (☞ xv) and “Caring for the Camera and Battery: Cautions” (☞ 55).

✔ If the CHARGE Lamp Flashes Rapidly

If the **CHARGE** lamp flashes rapidly (8 times a second):

- **A battery charging error has occurred:** Unplug the charger and remove and reinsert the battery.
- **The ambient temperature is too hot or too cold:** Use the battery charger at temperatures within the designated temperature range (0 – 40 °C).

If the problem persists, unplug the charger and end charging. Bring the battery and charger to a Nikon-authorized service representative.

Inserting the Battery

- Turn the camera off before inserting or removing the battery.
- Using the battery to keep the orange battery latch pressed to one side, slide the battery into the battery chamber until the latch locks it in place.

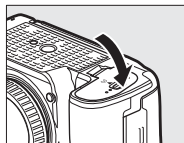
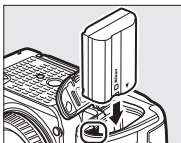
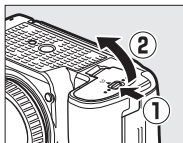

■ Removing the Battery

Turn the camera off and open the battery-chamber cover. Press the battery latch in the direction shown to release the battery and then remove the battery by hand.

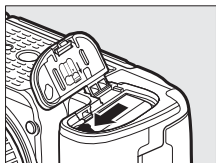

Attaching a Lens

- The lens generally used in this manual for illustrative purposes is an AF-S NIKKOR 24–120mm f/4G ED VR.
- Be careful to prevent dust entering the camera.
- Confirm that the camera is off before attaching the lens.
 - Remove the camera body cap (①, ②) and rear lens cap (③, ④).

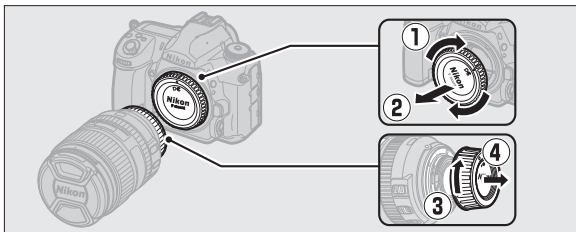

- Align the mounting marks on the camera (⑤) and lens (⑥).

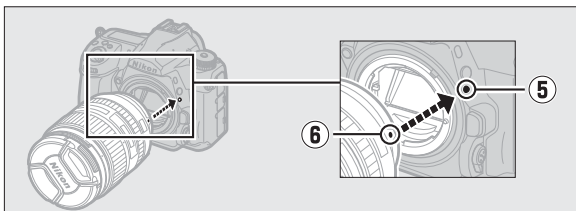

- Rotate the lens as shown until it clicks into place (7, 8).



- Remove the lens cap before taking pictures.

✓ CPU Lenses with Aperture Rings

When using a CPU lens equipped with an aperture ring, lock aperture at the minimum setting (highest f-number).

■ Detaching Lenses

- After turning the camera off, press and hold the lens release button (1) while turning the lens in the direction shown (2).
- After removing the lens, replace the lens caps and camera body cap.

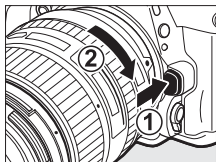

Inserting Memory Cards

- Turn the camera off before inserting or removing memory cards.
- The camera has two memory card slots: Slot 1 (①) and Slot 2 (②). If you are using only one memory card, insert it into Slot 1.

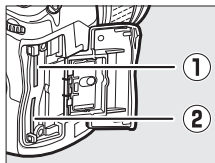

- Holding the memory card in the orientation shown, slide it straight into the slot until it clicks into place.

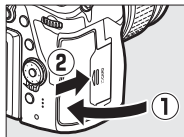
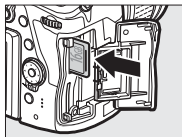
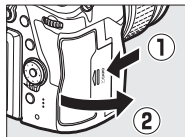

■ Removing Memory Cards

After confirming that the memory card access lamp is off, turn the camera off and open the memory card slot cover. Press the card in to eject it (①); the card can then be removed by hand (②).

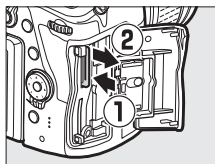

✔ Memory Cards

- Memory cards may be hot after use. Observe due caution when removing memory cards from the camera.
- Do not perform the following operations during formatting or while data are being recorded, deleted, or copied to a computer or other device. Failure to observe these precautions could result in loss of data or in damage to the camera or card.
 - Do not remove or insert memory cards
 - Do not turn the camera off
 - Do not remove the battery
 - Do not disconnect AC adapters
- Do not touch the card terminals with your fingers or metal objects.
- Do not use excessive force when handling memory cards. Failure to observe this precaution could damage the card.
- Do not bend or drop memory cards or subject them to strong physical shocks.
- Do not expose memory cards to water, heat, or direct sunlight.
- Do not format memory cards in a computer.

✔ No Memory Card Inserted

If no memory card is inserted, the exposure count displays in the control panel and viewfinder will show (- E -). If the camera is turned off with a battery and no memory card inserted, (- E -) will be displayed in the control panel.



✔ The Write Protect Switch

- SD memory cards are equipped with a write-protect switch. Sliding the switch to the “lock” position write-protects the card, protecting the data it contains.
- If you attempt to release the shutter while a write-protected card is inserted, a warning will be displayed and no picture will be recorded. Unlock the memory card before attempting to take or delete pictures.

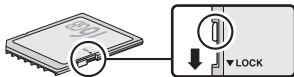

Camera Setup



Choose a language and set the camera clock. Pictures cannot be taken nor settings adjusted until the clock is set.

1 Turn the camera on.

When the camera is turned on for the first time after purchase, a language-selection dialog will be displayed. The languages available vary with the country or region in which the camera was originally purchased.

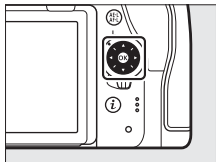
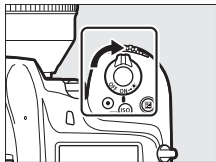
Use the multi selector and **OK** button to navigate the menus.



Press  and  to highlight a language and press **OK** to select. The language can be changed at any time using the [**Language**] item in the setup menu.

2 Set the camera clock.

Use the multi selector and **OK** button to set the camera clock.



Select time zone



Select date format



Select daylight saving time option



Set time and date (note that the camera uses a 24-hour clock)

The clock can be adjusted at any time using the **[Time zone and date] > [Date and time]** item in the setup menu.

✓ The **CLOCK** (“Clock Not Set”) Icon

Flashing **CLOCK** icon in the control panel indicates that the camera clock has been reset. The date and time recorded with new photographs will not be correct; use the [Time zone and date] > [Date and time] item in the setup menu to set the clock to the correct time and date. The camera clock is powered by an independent clock battery. The clock battery charges when the main battery is inserted or the camera is powered by an optional power connector and AC adapter. It takes about 2 days to charge. Once charged, it will power the clock for about a month.

📱 SnapBridge

Use the SnapBridge app to synchronize the camera clock with the clock on a smartphone or tablet (smart device). See SnapBridge online help for details.



The Battery Level and Number of Exposures Remaining

Before taking photographs, check the battery level and number of exposures remaining.

Battery Level

Check the battery level before taking photographs. The battery level is shown in the control panel and viewfinder.

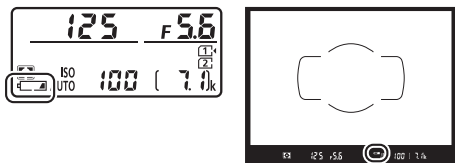

Control panel	Viewfinder	Description
	—	Battery fully charged.
	—	Battery partially discharged.
	—	
	—	
		Low battery. Charge battery or ready spare battery.
(flashes)	(flashes)	Shutter release disabled. Charge or exchange battery.

Memory Card Indicators and Number of Exposures Remaining

The control panel and viewfinder show the number of additional photographs that can be taken at current settings (i.e, the number of exposures remaining).

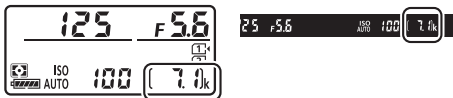

- The control panel shows the slot or slots that currently hold a memory card (the example shows the icons displayed when cards are inserted in both slots).
- At default settings, **[Overflow]** is selected for **[Role played by card in Slot 2]** in the photo shooting menu. When two memory cards are inserted, pictures will first be recorded to the card in Slot 1, switching to Slot 2 when the card in Slot 1 is full.

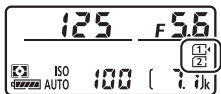

- If two memory cards are inserted, the camera will show the number of additional photographs that can be recorded to the card in Slot 1. When the card in Slot 1 is full, the display will show the number of exposures remaining on the card in Slot 2.
- Values over 1000 are rounded down to the nearest hundred. For example, values between 1400 and 1499 are shown as 1.4 k.
- If the memory card is full or locked or a card error has occurred, the icon for the affected slot will flash.

Basic Photography and Playback

Taking Photographs (AUTO Mode)

Select ^{AUTO} (auto) mode for simple “point-and-shoot” photography. Photographs can be framed in the viewfinder (viewfinder photography) or in the monitor (live view photography).

Framing Photographs in the Viewfinder (Viewfinder Photography)

- 1 Pressing the mode dial lock release on top of the camera, rotate the mode dial to ^{AUTO}.

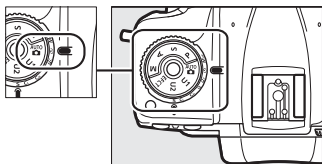

2 Ready the camera.

Holding the handgrip in your right hand and cradling the camera body or lens with your left, bring your elbows in against the sides of your chest.



3 Frame the photograph.

- *Frame a photograph in the viewfinder.*
- Position the main subject in the AF-area brackets.

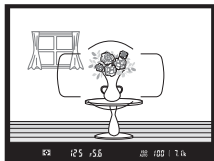

4 Press the shutter-release button halfway to focus.



- The in-focus indicator (●) will appear in the viewfinder when the focus operation is complete.

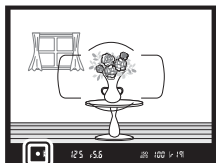

Viewfinder display	Description
● (steady)	The subject is in focus.
▶ (steady)	The focus point is in front of the subject.
◀ (steady)	The focus point is behind the subject.
▶ ◀ (flashes)	The camera is unable to focus using autofocus.

- The active focus point is displayed in the viewfinder.

5 Smoothly press the shutter-release button the rest of the way down to take the photograph.



The memory card access lamp will light while the photograph is being recorded. *Do not eject the memory card or remove or disconnect the power source until the lamp has gone out and recording is complete.*

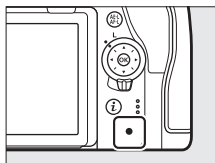

The Standby Timer (Viewfinder Photography)

The camera uses a standby timer to help reduce the drain on the battery. The timer starts when the shutter-release button is pressed halfway and expires if no operations are performed for about 6 seconds. The viewfinder display and some indicators in the control panel turn off when the timer expires. To restart the timer and restore the displays, press the shutter-release button halfway a second time. The length of time before the standby timer expires can be adjusted using Custom Setting c2 [Standby timer].

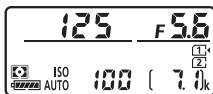

 125 F5.6 ISO 100 (7.0)k

Standby timer on

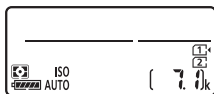

Standby timer off

Framing Photographs in the Monitor (Live View)

- 1 Pressing the mode dial lock release on top of the camera, rotate the mode dial to .**

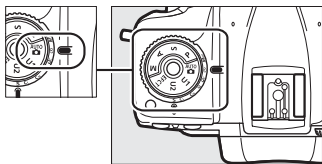

- 2 Rotate the live view selector to  (live view photography).**

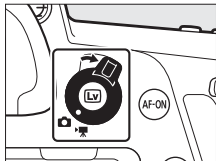

- 3 Press the  button.**

The mirror will be raised and live view will start. The viewfinder will go dark and the view through the lens will be displayed in the monitor.

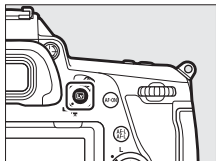

4 Ready the camera.

Hold the handgrip securely in your right hand and cradle the camera body or lens with your left.

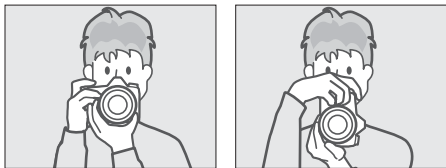

5 Frame the photograph.

- Position the subject near the center of the frame.
- At default settings, the camera automatically detects portrait subjects and positions the focus point over their faces or eyes.



6 Press the shutter-release button halfway to focus.

If the camera is able to focus, the focus point will be displayed in green. If the camera is unable to focus, for example because the subject is too close to the camera, the focus area will flash red.



7 Press the shutter-release button the rest of the way down to take the photograph.

The monitor turns off during shooting.



8 Press the  button to exit live view.

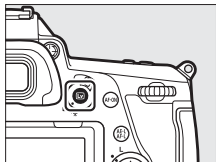

✔ Shooting in Live View

- Although these effects are not visible in the final pictures, during live view you may notice that:
 - Moving objects in the display appear distorted (individual subjects such as trains or cars moving at high speed through the frame may be distorted, or the entire frame may appear distorted when the camera is panned horizontally)
 - Jagged edges, color fringing, *moiré*, and bright spots are present in the display
 - Bright regions or bands may appear in scenes lit by flashing signs and other intermittent light sources or when the subject is briefly illuminated by a strobe or other bright, momentary light source
- Flicker and banding visible in the monitor under fluorescent, mercury vapor, or sodium lamps can be reduced using the **[Flicker reduction]** item in the movie shooting menu, although they may still be visible in photographs taken at some shutter speeds.
- To prevent light entering via the viewfinder from interfering with photographs or exposure, we recommend that you cover the viewfinder with the supplied eyepiece cap (☐ 9).
- When shooting in live view, avoid pointing the camera at the sun or other bright light sources. Failure to observe this precaution could result in damage to the camera's internal circuitry.
- Regardless of the option selected for Custom Setting c2 [**Standby timer**], the standby timer will not expire during live view.

☑ **The Count Down Display**

A count down will appear in the top left corner of the display approximately 30 s before live view ends automatically.

- If the timer has been triggered by Custom Setting c4 [**Monitor off delay**], the count down will be displayed in black starting 30 s before the timer expires, switching to red when there are only 5 s to go. If [**No limit**] is selected for [**Monitor off delay**] > [**Live view**], the camera may nevertheless terminate live view as necessary to protect its internal circuits from high temperatures and the like.
 - A count down will be displayed in red starting 30 s before the camera shuts down to protect its internal circuits. Depending on shooting conditions, the timer may appear immediately when live view is selected.
-

☑ **Exposure Preview (Lv)**

When [**On**] is selected for Custom Setting d9 [**Exposure preview (Lv)**], exposure can be previewed in the monitor during live view photography. You may find this useful when using exposure compensation or shooting in mode **M**.

☑ **Touch Controls**

Touch controls can be used in place of the shutter-release button to focus and take pictures during live view photography.

Recording Movies (AUTO Mode)

 (auto) mode can also be used for simple “point-and-shoot” movie recording.

“Filming” Versus “Recording”

Throughout this manual, the terms “filming” and “recording” are used as follows: “filming” is used if the live view selector is rotated to , while “recording” refers to the act of shooting footage using the movie-record button.

- 1 Pressing the mode dial lock release on top of the camera, rotate the mode dial to .**

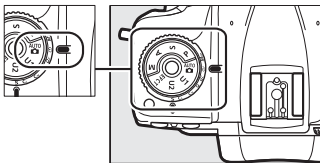

- 2 Rotate the live view selector to  (movie live view).**

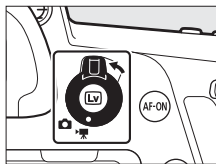

3 Press the **[Lv]** button.

- The mirror will be raised and live view will start. The viewfinder will go dark and the view through the lens will be displayed in the monitor.
- During live view, exposure for movies and photographs can be previewed in the monitor.

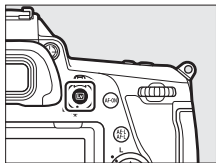

4 Press the **movie-record button** to start recording.

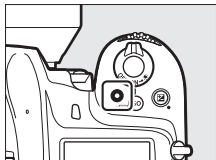

- A recording indicator will be displayed in the monitor. The monitor also shows the time remaining, or in other words the approximate amount of new footage that can be recorded to the memory card.

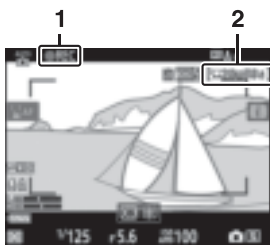

- | | |
|---|---------------------|
| 1 | Recording indicator |
| 2 | Time remaining |

- Sound is recorded via the built-in microphone. Do not cover the microphone during recording.
- Focus can be adjusted by tapping your subject in the monitor.

5 Press the movie-record button again to end recording.

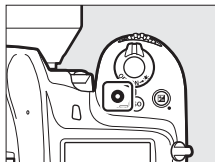

6 Press the **[Lv]** button to exit live view.

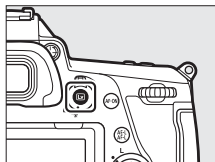

✔ Recording Movies



- When filming movies, you may notice the following in the display. These phenomena will also be visible in any footage recorded with the camera.
 - Flicker or banding in scenes lit by such sources as fluorescent, mercury vapor, or sodium lamps
 - Distortion associated with motion (individual subjects such as trains or cars moving at high speed through the frame may be distorted, or the entire frame may appear distorted when the camera is panned horizontally)
 - Jagged edges, color fringing, *moiré*, and bright spots in the display
 - Bright regions or bands in scenes lit by flashing signs and other intermittent light sources or when the subject is briefly illuminated by a strobe or other bright, momentary light source
 - Flicker occurring while power aperture is in use
- Note that noise (randomly-spaced bright pixels, fog, or lines) and unexpected colors may appear if you use the  (**QUAL**) button to zoom in on the view through the lens during filming.
- Movie recording will end automatically if:
 - The maximum length is reached
 - The live view selector is rotated to another setting
 - The lens is removed
- When recording movies, avoid pointing the camera at the sun or other strong light sources. Failure to observe this precaution could result in damage to the camera's internal circuitry.

- Sounds made by the camera may be audible in footage recorded:
 - During autofocus
 - When power aperture is used
 - During aperture adjustment
 - With vibration reduction enabled on vibration reduction (VR) lenses
- If the sound level is displayed in red, the volume is too high. Adjust microphone sensitivity.

✔ The Count-Down Display

- A count-down timer will be displayed in the top left corner of the monitor 30 s before movie recording ends automatically.
- Depending on shooting conditions, the timer may appear immediately when movie recording begins.
- Note that regardless of the time available (displayed in the top right corner of the monitor), filming will end automatically when the count-down timer expires.

✔ Adjusting Settings During Movie Recording

- Headphone volume cannot be adjusted during recording.
- If an option other than  (microphone off) is currently selected, microphone sensitivity can be changed while recording is in progress.  cannot be selected.

Focusing During Movie Recording

Focus can also be adjusted by pressing the shutter-release button halfway.

Taking Photos During Filming

Photos can be taken during filming by pressing the shutter-release button all the way down. The resulting photo will have an aspect ratio of 16:9.



- A  icon will flash in the display when a photo is taken.
- Photos can be taken while recording is in progress. Taking photos does not interrupt movie recording.



✓ Taking Photos During Filming

- Up to 40 photographs can be taken with each movie.
 - Note that photos can be taken even when the subject is not in focus.
 - Photos are recorded at the dimensions currently selected for movie frame size.
 - Photos are recorded in [**JPEG fine★**] format, regardless of the option selected for image quality.
 - The frame advance rate for continuous release modes varies with the option selected for [**Frame size/frame rate**]. While recording is in progress, only one photo will be taken each time the shutter-release button is pressed.
 - Photographs taken during filming will not be displayed automatically after shooting even if [**On**] is selected for [**Image review**] in the playback menu.
-

Playback

Press the  button to view photos and movies recorded with the camera.

1 Press the button.

- A picture will be displayed in the monitor.
- The memory card containing the picture currently displayed is shown by an icon.

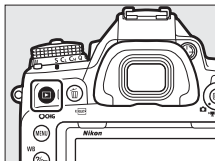

2 Press or to view additional pictures.



- Additional pictures can also be viewed by flicking a finger left or right over the display.
- To end playback and return to shooting mode, press the shutter-release button halfway.

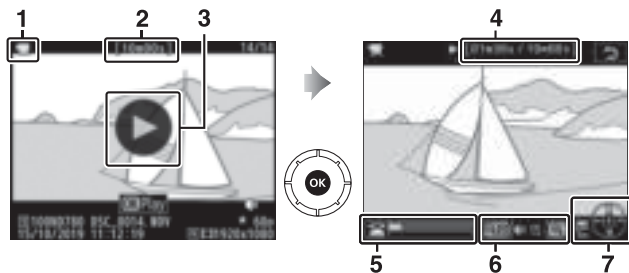



Image Review

When **[On]** is selected for **[Image review]** in the playback menu, pictures are automatically displayed in the monitor after shooting without the user pressing the  button.















Viewing Movies

Movies are indicated by a  icon. Tap the  icon in the display or press  to start playback (a progress bar shows your approximate position in the movie).



- 1  icon
- 2 Length
- 3  icon
- 4 Current position/total length
- 5 Progress bar
- 6 Volume
- 7 Guide

Movie Playback Operations

To	Description
Pause	Press  to pause playback.
Resume	Press  to resume playback when playback is paused or during rewind/advance.
Rewind/advance	<ul style="list-style-type: none">Press  to rewind,  to advance. Speed increases with each press, from 2x to 4x to 8x to 16x.Keep  or  pressed to skip respectively to the first frame or last frame.The first frame is indicated by a  in the top right corner of the display, the last frame by a .  
Start slow-motion playback	Press  while the movie is paused to start slow-motion playback.
Jog rewind/advance	<ul style="list-style-type: none">Press  or  while the movie is paused to rewind or advance one frame at a time.Keep  or  pressed for continuous rewind or advance.
Skip 10 s	Rotate the main command dial one stop to skip ahead or back 10 s.
Skip to last or first frame	If the movie contains no indices, you can skip to the first or last frame by rotating the sub-command dial.

To	Description
Skip to index	If the movie contains indices, rotating the sub-command dial takes you to the next or previous index. <ul style="list-style-type: none"> Indices can be added or removed from the [EDIT MOVIE] menu, which can be displayed by pausing playback and pressing the i button.
Adjust volume	Press QUAL to increase volume, QUAL (Q) to decrease.
Trim movie	To display the [EDIT MOVIE] menu, pause playback and press the i button.
Exit	Press Q or Q to exit to full-frame playback.
Exit to shooting mode	Press the shutter-release button halfway to exit playback and return to shooting mode.

Indices



Indices can be added when playback is paused by pressing the **i** button and selecting **[Add index]**. You can quickly jump to indexed locations during playback and editing. The presence of indices is indicated by a **i** icon in the full-frame playback display.



Deleting Unwanted Pictures



Pictures can be deleted as described below. *Note that once deleted, pictures cannot be recovered.*

1 Display the picture.

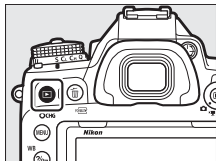
- Press the  button to start playback and press  or  until the desired picture is displayed.
- The location of the current image is shown by an icon at the bottom left corner of the display.



2 Delete the picture

- Press the  (FORMAT) button; a confirmation dialog will be displayed. Press the  (FORMAT) button again to delete the image and return to playback.
- To exit without deleting the picture, press .

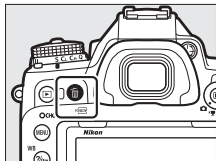

Technical Notes

Caring for the Camera and Battery: Cautions

Camera Care

● **Do Not Drop**

Do not drop the camera or lens or subject them to blows. The product may malfunction if subjected to strong shocks or vibration.

● **Keep Dry**

Keep the camera dry. Rusting of the internal mechanism caused by water inside the camera can not only be expensive to repair but can in fact cause irreparable damage.

● **Avoid Sudden Changes in Temperature**

Sudden changes in temperature, such as those that occur when entering or leaving a heated building on a cold day, can cause condensation inside the device. To prevent condensation, place the device in a carrying case or plastic bag before exposing it to sudden changes in temperature.

● **Keep Away from Strong Magnetic Fields**

Static charges or the magnetic fields produced by equipment such as radio transmitters could interfere with the monitor, corrupt data stored on the memory card, or affect the product's internal circuitry.

● **Do Not Leave the Lens Pointed at the Sun**

Do not leave the lens pointed at the sun or other strong light source for extended periods. Intense light may damage the image sensor or cause fading or "burn in". Photographs taken with the camera may exhibit a white blur effect.

● **Lasers and other bright light sources**

Do not direct lasers or other extremely bright light sources toward the lens, as this could damage the camera's image sensor.

● **Cleaning**

When cleaning the camera body, use a blower to gently remove dust and lint, then wipe gently with a soft, dry cloth. After using the camera at the beach or seaside, wipe off any sand or salt using a cloth lightly dampened in fresh water and then dry the camera thoroughly. In rare instances, static electricity may cause the LCD display to light up or go dark; this does not indicate a malfunction. The display will soon return to normal.

● **Cleaning the Lens and Mirror**

These elements are easily damaged: remove dust and lint with a blower. If using an aerosol blower, keep the can vertical to prevent the discharge of liquid that could damage glass elements. To remove fingerprints and other stains from the lens, apply a small amount of lens cleaner to a soft cloth and wipe the lens carefully.

● **The Lens Contacts**

Keep the lens contacts clean.

● **Do Not Touch the Shutter Curtain**

- The shutter curtain is extremely thin and easily damaged: under no circumstances should you exert pressure on the curtain, poke it with cleaning tools, or subject it to powerful air currents from a blower. These actions could scratch, deform, or tear the curtain.
- The shutter curtain may appear to be unevenly colored; this does not indicate a malfunction. It also has no effect on pictures.

● **Store in a Well-Ventilated Area**

To prevent mold or mildew, store the camera in a dry, well-ventilated area. Do not store the camera with naphtha or camphor moth balls, next to equipment that produces strong electromagnetic, or where it will be exposed to extremely high temperatures, for example near a heater or in an enclosed vehicle on a hot day. Failure to observe these precautions could result in product malfunction.

● **Long-Term Storage**

To prevent damage caused by, for example, leaking battery fluid, remove the battery if the product will not be used for an extended period. Store the camera in a plastic bag containing a desiccant. Do not, however, store the camera case in a plastic bag, as this may cause the material to deteriorate. Store the battery in a cool, dry place. Note that desiccant gradually loses its capacity to absorb moisture and should be replaced at regular intervals. To prevent mold or mildew, take the camera out of storage at least once a month, insert the battery, and release the shutter a few times.

● **Turn the Product Off Before Removing or Disconnecting the Power Source**

Removing or disconnecting the power source while the camera is on could damage the product. Particular care should be taken not to remove or disconnect the power source while images are being recorded or deleted.

● **Notes on the Monitor**

- The monitor is constructed with extremely high precision; at least 99.99% of pixels are effective, with no more than 0.01% being missing or defective. Hence while these displays may contain pixels that are always lit (white, red, blue, or green) or always off (black), this is not a malfunction. Images recorded with the device are unaffected. Your understanding is requested.
- Images in the monitor may be difficult to see in a bright light.
- Do not apply pressure to the monitor. The monitor could malfunction or suffer damage. Dust or lint on the monitor can be removed with a blower. Stains can be removed by wiping the monitor lightly with a soft cloth or chamois leather. Should the monitor break, care should be taken to avoid injury from broken glass. Be careful that liquid crystal from the monitor does not touch the skin or enter the eyes or mouth.

● **Bright Lights and Back-Lit Subjects**

Noise in the form of lines may in rare cases appear in pictures that include bright lights or back-lit subjects.

Battery Care

● Precautions for Use

- If improperly handled, batteries may rupture or leak, causing the product to corrode. Observe the following precautions when handling batteries:
 - Turn the product off before replacing the battery.
 - Batteries may be hot after extended use.
 - Keep the battery terminals clean.
 - Use only batteries approved for use in this equipment.
 - Do not short or disassemble batteries or expose them to flame or excessive heat.
 - Replace the terminal cover when the battery is not inserted in the camera or charger.
- If the battery is hot, for example immediately after use, wait for it to cool before charging. Attempting to charge the battery while its internal temperature is elevated will impair battery performance, and the battery may not charge or charge only partially.
- If the battery will not be used for some time, insert it in the camera and run it flat before removing it from the camera for storage. The battery should be stored in a cool location with an ambient temperature of 15 °C to 25 °C (59 °F to 77 °F). Avoid hot or extremely cold locations.
- Batteries should be charged within six months of use. During long periods of disuse, charge the battery and use the camera to run it flat once every six months before returning it to a cool location for storage.

- Remove the battery from the camera or charger when not in use. The camera and charger draw minute amounts of charge even when off and could draw the battery down to the point that it will no longer function.
- Do not use the battery at ambient temperatures below 0 °C (32 °F) or above 40 °C (104 °F). Failure to observe this precaution could damage the battery or impair its performance. Charge the battery indoors at ambient temperatures of 5 °C–35 °C (41 °F–95 °F). The battery will not charge if its temperature is below 0 °C (32 °F) or above 60 °C (140 °F).
- Capacity may be reduced and charging times increase at battery temperatures from 0 °C (32 °F) to 15 °C (59 °F) and from 45 °C (113 °F) to 60 °C (140 °F).
- Batteries in general exhibit a drop in capacity at low ambient temperatures. Even fresh batteries charged at temperatures under about 5 °C (41 °F) may show a temporary increase from “0” to “1” in the setup menu [**Battery info**] age display, but the display will return to normal once the battery has been recharged at a temperature of about 20 °C (68 °F) or higher.
- Battery capacity drops at low temperatures. The change in capacity with temperature is reflected in the camera battery-level display. As a result, the battery display may show a drop in capacity as the temperature drops, even if the battery is fully charged.
- Batteries may be hot after use. Observe due caution when removing batteries from the camera.

● **Charge Batteries Before Use**

Charge the battery before use. The supplied battery is not fully charged at shipment.

● **Ready Spare Batteries**

Before taking photographs, ready a spare battery and keep it fully charged. Depending on your location, it may be difficult to purchase replacement batteries on short notice.

● **Have Fully-Charged Spare Batteries Ready on Cold Days**

Partially-charged batteries may not function on cold days. In cold weather, charge one battery before use and keep another in a warm place, ready to be exchanged as necessary. Once warmed, a cold battery may recover some of its charge.

● **Battery Level**

- Turning the camera on or off repeatedly when the battery is fully discharged will shorten battery life. Batteries that have been fully discharged must be charged before use.
- A marked drop in the time a fully charged battery retains its charge when used at room temperature indicates that it requires replacement. Purchase a new rechargeable battery.

● **Do Not Attempt to Charge Fully-Charged Batteries**

Continuing to charge the battery after it is fully charged can impair battery performance.

● **Recycling Used Batteries**

Recycle rechargeable batteries in accord with local regulations, being sure to first insulate the terminals with tape.

Using the Charger

- Do not move the charger or touch the battery during charging; failure to observe this precaution could in very rare instances result in the charger showing that charging is complete when the battery is only partially charged. Remove and reinsert the battery to begin charging again.
- Do not short the charger terminals. Failure to observe this precaution could result in overheating and damage to the charger.
- Unplug the charger when it is not in use.
- Use the MH-25a with compatible batteries only.
- Do not use chargers with damage that leaves the interior exposed or that produce unusual sounds when used.

Using the Charging AC Adapter

- Do not move the camera or touch the battery during charging. Failure to observe this precaution could in very rare instances result in the camera showing that charging is complete when the battery is only partially charged. Disconnect and reconnect the adapter to begin charging again.
- Do not short the adapter terminals. Failure to observe this precaution could result in overheating and damage to the adapter.
- Unplug the adapter when it is not in use.
- Do not use adapters with damage that leaves the interior exposed or that produce unusual sounds when used.

Specifications

Nikon D780 Digital Camera

Type

Type	Single-lens reflex digital camera
Lens mount	Nikon F mount (with AF coupling and AF contacts)
Effective angle of view	Nikon FX format

Effective pixels

Effective pixels	24.5 million
-------------------------	--------------

Image sensor

Type	35.9 × 23.9 mm CMOS sensor
Total pixels	25.28 million
Dust-reduction system	Image sensor cleaning, Image Dust Off reference data (Capture NX-D software required)

Storage

Image size (pixels)	<ul style="list-style-type: none">• FX (36×24) image area:<ul style="list-style-type: none">- 6048 × 4024 (Large: 24.3 M)- 4528 × 3016 (Medium: 13.7 M)- 3024 × 2016 (Small: 6.1 M)• DX (24×16) image area:<ul style="list-style-type: none">- 3936 × 2624 (Large: 10.3 M)- 2944 × 1968 (Medium: 5.8 M)- 1968 × 1312 (Small: 2.6 M)• 1:1 (24×24) image area:<ul style="list-style-type: none">- 4016 × 4016 (Large: 16.1 M)- 3008 × 3008 (Medium: 9.0 M)- 2000 × 2000 (Small: 4.0 M)• 16:9 (36×20) image area:<ul style="list-style-type: none">- 6048 × 3400 (Large: 20.6 M)- 4528 × 2544 (Medium: 11.5 M)- 3024 × 1696 (Small: 5.1 M)• Photographs taken while filming movies at a frame size of 3840 × 2160: 3840 × 2160• Photographs taken while filming movies at other frame sizes: 1920 × 1080
File format (image quality)	<ul style="list-style-type: none">• NEF (RAW): 12 or 14 bit (lossless compressed or compressed)• JPEG: JPEG-Baseline compliant with fine (approx. 1:4), normal (approx. 1:8), or basic (approx. 1:16) compression; size-priority and optimal-quality compression available• NEF (RAW)+JPEG: Single photograph recorded in both NEF (RAW) and JPEG formats

Storage	
Picture Control System	Auto, Standard, Neutral, Vivid, Monochrome, Portrait, Landscape, Flat, Creative Picture Controls (Dream, Morning, Pop, Sunday, Somber, Dramatic, Silence, Bleached, Melancholic, Pure, Denim, Toy, Sepia, Blue, Red, Pink, Charcoal, Graphite, Binary, Carbon); selected Picture Control can be modified; storage for custom Picture Controls
Media	SD (Secure Digital) and UHS-II compliant SDHC and SDXC memory cards
Double card slots	The card in Slot 2 can be used for overflow or backup storage or for separate storage of NEF (RAW) and JPEG images; pictures can be copied between cards.
File system	DCF 2.0, Exif 2.31
Viewfinder	
Viewfinder	Eye-level pentaprism single-lens reflex viewfinder
Frame coverage	<ul style="list-style-type: none"> • FX: Approx. 100% horizontal and 100% vertical • DX: Approx. 97% horizontal and 97% vertical • 1:1: Approx. 97% horizontal and 100% vertical • 16:9: Approx. 100% horizontal and 97% vertical
Magnification	Approx. 0.7× (50 mm f/1.4 lens at infinity, -1.0 m^{-1})
Eyepoint	21 mm (-1.0 m^{-1} ; from center surface of viewfinder eyepiece lens)
Diopter adjustment	$-3 - +1 \text{ m}^{-1}$

Viewfinder	
Focusing screen	Type B BriteView Clear Matte Mark VIII screen (with AF-area brackets; framing grid can be displayed)
Reflex mirror	Quick return
Depth-of-field preview	Pressing Pv button stops lens aperture down to value selected by user (A and M modes) or by camera (P and S modes)
Lens aperture	Instant return, electronically controlled

Lens	
Compatible lenses	<ul style="list-style-type: none"> • Types G, E, and D (some restrictions apply to PC lenses) • Other AF NIKKOR lenses (excluding IX NIKKOR lenses and lenses for the F3AF) • AI-P NIKKOR lenses • DX lenses (using [DX (24 × 16)] image area) • Non-CPU AI lenses (modes A and M only) • During viewfinder photography, the electronic rangefinder can be used with lenses that have a maximum aperture of f/5.6 or faster. With lenses that have a maximum aperture of f/8 or faster, the electronic rangefinder supports 11 focus points.

Shutter	
Type	Electronically-controlled vertical-travel focal-plane mechanical shutter; electronic front-curtain shutter; electronic shutter
Speed	$1/8000$ –30 s (choose from step sizes of $1/3$ and $1/2$ EV, extendable to 900 s in mode M); Bulb; Time; X200
Flash sync speed	$X=1/200$ s; synchronizes with shutter at $1/200$ s or slower <ul style="list-style-type: none"> • Auto FP high-speed sync supported
Release	
Release mode	S (single frame), CL (continuous low speed), CH (continuous high speed), Q (quiet shutter-release), QC (quiet continuous shutter-release), ⌚ (self-timer), MUP (mirror up)
Approximate frame advance rate	<ul style="list-style-type: none"> • CL: 1 – 6 fps (viewfinder photography); 1–3 fps (live view photography) • CH: 7 fps; when shooting NEF/RAW pictures during silent photography, either 8 fps (bit depth 14 bits) or 12 fps (bit depth 12 bits) • QC: 3 fps
Self-timer	2 s, 5 s, 10 s, 20 s; 1 – 9 exposures at intervals of 0.5, 1, 2, or 3 s

Exposure	
Metering system	<ul style="list-style-type: none"> • Viewfinder photography: TTL exposure metering using RGB sensor with approximately 180K (180,000) pixels • Live view: TTL exposure metering performed by image sensor
Metering mode	<ul style="list-style-type: none"> • Matrix: 3D color matrix metering III (type G, E, and D lenses); color matrix metering III (other CPU lenses); color matrix metering available with non-CPU lenses if user provides lens data • Center-weighted: Weight of 75% given to 12 mm circle in center of frame; diameter of circle can be changed to 8, 15, or 20 mm, or weighting can be based on average of entire frame (non-CPU and AF-S Fisheye NIKKOR 8–15mm f/3.5–4.5E ED lenses use 12-mm circle) • Spot: Meters circle approximately 4 mm in diameter (about 1.5% of frame) centered on selected focus point (on center focus point when non-CPU or AF-S Fisheye NIKKOR 8–15mm f/3.5–4.5E ED lens is used) • Highlight-weighted: Available with type G, E, and D lenses
Range*	<ul style="list-style-type: none"> • Matrix and center-weighted metering: –3 – +20 EV • Spot metering: 2 – 20 EV • Highlight-weighted metering: 0 – 20 EV <p>* Figures are for ISO 100 and f/1.4 lens at 20 °C/68 °F</p>

Exposure	
Exposure meter coupling	Combined CPU and AI
Mode	<p><small>AUTO</small> : Auto, P: programmed auto with flexible program, S: shutter-priority auto, A: aperture-priority auto, M: manual</p> <ul style="list-style-type: none"> • EFCT Special effects modes: night vision; VI super vivid; POP pop; photo illustration; toy camera effect; miniature effect; selective color; silhouette; high key; low key • U1 and U2: user settings
Exposure compensation	-5 – +5 EV; -3 – +3 EV when filming movies (choose from step sizes of 1/3 and 1/2 EV) available in P, S, A, M, and EFCT modes
Exposure lock	Luminosity locked at detected value
ISO sensitivity (Recommended Exposure Index)	ISO 100–51200 (choose from step sizes of 1/3 and 1/2 EV); can also be set to approx. 0.3, 0.5, 0.7, or 1 EV (ISO 50 equivalent) below ISO 100 or to approx. 0.3, 0.5, 0.7, 1, or 2 EV (ISO 204800 equivalent) above ISO 51200; auto ISO sensitivity control available
Active D-Lighting	Can be selected from Auto, Extra high, High, Normal, Low, or Off



Autofocus	
Type	<ul style="list-style-type: none"> • Viewfinder photography: TTL phase detection performed using Advanced Multi-CAM 3500 II autofocus sensor module with support for 51 focus points (including 15 cross-type sensors; f/8 supported by 11 sensors); autofocus fine-tuning supported • Live view: Hybrid phase-detection/contrast-detect AF performed by image sensor; autofocus fine-tuning supported
Detection range	<ul style="list-style-type: none"> • Viewfinder photography¹: -3 – +19 EV • Live view²: -5 – +19 EV; -7 – +19 EV with low-light AF <p>1 Figures are for ISO 100 at 20 °C/68 °F. 2 Still photography using single-servo AF (AF-S) and apertures of f/1.4 at dark end of range and f/5.6 at bright end of range; ISO 100; 20 °C/68 °F</p>
Lens servo	<ul style="list-style-type: none"> • Autofocus (AF): Single-servo AF (AF-S); continuous-servo AF (AF-C); AF mode auto-switch (AF-A, still photography only); full-time AF (AF-F, movie recording only); predictive focus tracking activated automatically according to subject status • Manual focus (M): Electronic rangefinder can be used
Focus points	<ul style="list-style-type: none"> • Viewfinder photography: 51 points with [All points] selected for Custom Setting a6 [Focus points used], 11 points with [Every other point] selected • Live view[*]: 273 points with [All points] selected for Custom Setting a6 [Focus points used], 77 points with [Every other point] selected <p>[*] Still photography, [FX (36×24)] image area, single-point AF</p>

Autofocus

AF-area mode	<ul style="list-style-type: none">• Viewfinder photography: Single-point AF, 9-, 21-, or 51- point dynamic-area AF, 3D-tracking, group-area AF, auto-area AF• Live view: Pinpoint AF (still photography only, single-servo AF/AF-S), single-point AF, dynamic-area AF (still photography only, continuous-servo AF/AF-C), wide-area AF (S), wide-area AF (L), auto-area AF
Focus lock	Focus can be locked by pressing shutter-release button halfway (single-servo AF/ AF-S) or by pressing $\frac{1}{2}$ button

Flash

Flash control	<ul style="list-style-type: none">• Viewfinder photography: TTL flash control performed by RGB sensor with approximately 180K (180,000) pixels• Live view photography: TTL flash control performed by image sensor• i-TTL balanced fill flash for digital SLR available with matrix, center-weighted, and highlight-weighted metering; standard i-TTL fill-flash for digital SLR available with spot metering
Flash mode	Front-curtain sync, red-eye reduction, slow sync, red-eye reduction with slow sync, rear-curtain sync, off
Flash compensation	-3 – +1 EV (choose from step sizes of $\frac{1}{3}$ and $\frac{1}{2}$ EV) available in P , S , A , and M modes

Flash	
Flash-ready indicator	Lights when optional flash unit is fully charged; flashes after flash is fired at full output
Accessory shoe	ISO 518 hot-shoe with sync and data contacts and safety lock
Nikon Creative Lighting System (CLS)	i-TTL flash control, radio-controlled Advanced Wireless Lighting, optical Advanced Wireless Lighting, modeling illumination, FV lock, Color Information Communication, auto FP high-speed sync, AF-assist for multi-area AF (viewfinder photography), unified flash control
Sync terminal	AS-15 sync terminal adapter (available separately)
White balance	
White balance	Auto (3 types), natural light auto, direct sunlight, cloudy, shade, incandescent, fluorescent (7 types), flash, choose color temperature (2500 K–10,000 K), preset manual (up to 6 values can be stored, spot white balance measurement available during live view photography), all except choose color temperature with fine-tuning
Bracketing	
Bracketing	Exposure and/or flash, white balance, and ADL
Live view	
Mode	 (photo live view),  (movie live view)

Movie	
Metering system	TTL metering using camera image sensor
Metering mode	Matrix, center-weighted, or highlight-weighted
Frame size (pixels) and frame rate	<ul style="list-style-type: none"> • 3840 × 2160 (4K UHD); 30p (progressive), 25p, 24p • 1920 × 1080; 120p, 100p, 60p, 50p, 30p, 25p, 24p • 1920 × 1080 (slow-motion); 30p ×4, 25p ×4, 24p ×5 <p>* Actual frame rates for 120p, 100p, 60p, 50p, 30p, 25p, and 24p are 119.88, 100, 59.94, 50, 29.97, 25, and 23.976 fps respectively</p> <p>* Quality selection available at all sizes except 3840 × 2160, 1920 × 1080 120p/100p, and 1920 × 1080 slow-motion, when quality is fixed at ★ (high)</p>
File format	MOV, MP4
Video compression	H.264/MPEG-4 Advanced Video Coding
Audio recording format	Linear PCM, AAC
Audio recording device	Built-in stereo or external microphone with attenuator option; sensitivity adjustable

Movie	
ISO sensitivity (Recommended Exposure Index)	Manual selection (ISO 100 to 51200; choose from step sizes of $\frac{1}{3}$ and $\frac{1}{2}$ EV) with additional options available equivalent to approximately 0.3, 0.5, 0.7, 1, or 2 EV (ISO 204800 equivalent) above ISO 51200; auto ISO sensitivity control (ISO 100 to Hi 2) available with selectable upper limit
Active D-Lighting	Can be selected from Same as photo settings, Extra high, High, Normal, Low, or Off
Other options	Time-lapse movie recording, electronic vibration reduction, time codes, logarithmic (N-Log) and HDR (HLG) movie output
Monitor	
Monitor	8-cm/3.2-in., approx. 2359k-dot (XGA) tilting TFT touch-sensitive LCD with 170° viewing angle, approximately 100% frame coverage, 11-level manual brightness adjustment, and color balance control

Playback

Playback	Full-frame and thumbnail (4, 9, or 72 images or calendar) playback with playback zoom, playback zoom cropping, movie playback, photo and/or movie slide shows, histogram display, highlights, photo information, location data display, picture rating, auto image rotation, and index marking
-----------------	--

Interface

USB	Type C USB connector (SuperSpeed USB); connection to built-in USB port is recommended
HDMI output	Type C HDMI connector
Audio input	Stereo mini-pin jack (3.5mm diameter; plug-in power supported)
Audio output	Stereo mini-pin jack (3.5mm diameter)
Accessory terminal	Built-in (can be used with accessories such as the MC-DC2 remote cord)

Wi-Fi

- **Standards:**
 - IEEE 802.11b/g/n (Africa, Asia, and Oceania)
 - IEEE 802.11b/g/n/a/ac (Europe, U.S.A., Canada, and Mexico)
 - IEEE 802.11b/g/n/a (other countries in the Americas)
- **Operating frequency:**
 - 2412–2462 MHz (channel 11; Africa, Asia, and Oceania)
 - 2412–2462 MHz (channel 11) and 5180–5825 MHz (U.S.A., Canada, and Mexico)
 - 2412–2462 MHz (channel 11) and 5180–5805 MHz (other countries in the Americas)
 - 2412–2462 MHz (channel 11) and 5745–5805 MHz (Georgia)
 - 2412–2462 MHz (channel 11) and 5180–5320 MHz (other European countries)
- **Maximum output power (EIRP):**
 - 2.4 GHz band: 2.9 dBm
 - 5 GHz band: 5.7 dBm (Georgia)
 - 5 GHz band: 8.7 dBm (other countries)
- **Authentication:** Open system, WPA2-PSK

Wi-Fi/Bluetooth

Bluetooth	<ul style="list-style-type: none">• Communication protocols: Bluetooth Specification Version 4.2• Operating frequency:<ul style="list-style-type: none">- Bluetooth: 2402–2480 MHz- Bluetooth Low Energy: 2402–2480 MHz• Maximum output power (EIRP):<ul style="list-style-type: none">- Bluetooth: –2.6 dBm- Bluetooth Low Energy: –4.1 dBm
Range (line of sight)	Approximately 10 m (32 ft) * * Without interference. Range may vary with signal strength and presence or absence of obstacles.

Power source

Battery	One EN-EL15b rechargeable Li-ion battery * * EN-EL15a/EN-EL15 batteries can also be used. Note, however, that fewer pictures may sometimes be taken on a single charge with the EN-EL15 than with an EN-EL15b/EN-EL15a. EH-7P charging AC adapter can be used to charge EN-EL15b batteries only.
AC adapter	EH-5d/EH-5c/EH-5b AC adapter; requires EP-5B power connector (available separately)

Tripod socket**Tripod socket** 1/4 in. (ISO 1222)**Dimensions/weight****Dimensions (W × H × D)** Approx. 143.5 × 115.5 × 76 mm (5.7 × 4.6 × 3 in.)**Weight** Approx. 840 g (1 lb. 13.7 oz.) with battery and SD memory card but without body cap; approx. 755 g/1 lb. 10.7 oz. (camera body only)**Operating environment****Temperature** 0 °C–40 °C (+32 °F–104 °F)**Humidity** 85% or less (no condensation)

- Unless otherwise stated, all measurements are performed in conformity with Camera and Imaging Products Association (CIPA) standards or guidelines.
- All figures are for a camera with a fully-charged battery.
- The sample images displayed on the camera and the images and illustrations in the manuals are for expository purposes only.
- Nikon reserves the right to change the appearance and specifications of the hardware and software described in this manual at any time and without prior notice. Nikon will not be held liable for damages that may result from any mistakes that this manual may contain.

■ MH-25a Battery Charger

Rated input	AC 100–240 V, 50/60 Hz, 0.23–0.12 A
Rated output	DC 8.4 V/1.2 A
Supported batteries	EN-EL15b rechargeable Li-ion batteries
Charging time	Approx. 2 hours and 35 minutes * Time required to charge battery at an ambient temperature of 25 °C (77 °F) when no charge remains
Operating temperature	0 °C–40 °C (+32 °F–104 °F)
Dimensions (W × H × D)	Approx. 95 × 33.5 × 71 mm (3.7 × 1.3 × 2.8 in.), excluding projections
Length of power cable	Approx. 1.5 m (4.9 ft), if supplied
Weight	Approx. 115 g (4.1 oz), excluding supplied power connector (power cable or AC wall adapter)

The symbols on this product represent the following:

~ AC, = DC, □ Class II equipment (the construction of the product is double-insulated)

■ EN-EL15b Rechargeable Li-ion Battery:

Type	Rechargeable lithium-ion battery
Rated capacity	7.0 V/1900 mAh
Operating temperature	0 °C–40 °C (+32 °F–104 °F)
Dimensions (W× H × D)	Approx. 40 × 56 × 20.5 mm (1.6 × 2.2 × 0.8 in.)
Weight	Approx. 80 g (2.9 oz), excluding terminal cover

✔ **Disposing of Data Storage Devices**

Please note that deleting images or formatting memory cards or other data storage devices does not completely erase the original image data. Deleted files can sometimes be recovered from discarded storage devices using commercially available software, potentially resulting in the malicious use of personal image data. Ensuring the privacy of such data is the user's responsibility.

Before discarding a data storage device or transferring ownership to another person, erase all data using commercial deletion software, or format the device and then completely refill it with images containing no private information (for example, pictures of empty sky). Care should be taken to avoid injury when physically destroying data storage devices. Before discarding the camera or transferring ownership to another person, you should also use the **[Reset all settings]** item in the camera setup menu to delete network settings and other personal information.

☑ Supported Standards

- **DCF Version 2.0:** The Design Rule for Camera File System (DCF) is a standard widely used in the digital camera industry to ensure compatibility among different makes of camera.
 - **Exif version 2.31:** The camera supports Exif (Exchangeable Image File Format for Digital Still Cameras) version 2.31, a standard introduced with the goal of improving the interoperability of printers and digital cameras, making it easier to produce high-quality prints. Information stored with photographs is used for optimal color reproduction when the images are output on Exif-compliant printers. See the printer manual for details.
 - **HDMI:** High-Definition Multimedia Interface is a standard for multimedia interfaces used in consumer electronics and AV devices. This standard ensures that audiovisual data and control signals can be transmitted to HDMI-compliant devices via a single cable connection.
-

Approved Memory Cards

- The camera can be used with SD, SDHC, and SDXC memory cards.
- UHS-I and UHS-II are supported.
- Cards rated UHS Speed Class 3 or better are recommended for movie recording and playback. Slower speeds may result in recording or playback being interrupted.
- When choosing cards for use in card readers, be sure they are compatible with the device.
- Contact the manufacturer for information on features, operation, and limitations on use.



Battery Endurance

The movie footage or number of shots that can be recorded with a fully-charged EN-EL15b (1900 mAh) rechargeable Li-ion battery is given below. ¹ Actual endurance varies with such factors as the condition of the battery, the interval between shots, and the options selected in the camera menus.

- Photographs, single-frame release mode: Approximately 2260 (CIPA standard ²)
- Photographs, continuous release modes: Approximately 4570 (Nikon standard ³)
- Movies: Approximately 95 minutes ⁴

Actions such as the following can reduce battery endurance:

- Using the monitor, for example for live view photography
- Keeping the shutter-release button pressed halfway
- Repeated autofocus operations
- Taking NEF (RAW) photographs
- Slow shutter speeds
- Using camera Wi-Fi (wireless LAN) and Bluetooth features
- Using the camera with optional accessories connected
- Using VR (vibration reduction) mode with VR lenses
- Repeatedly zooming in and out with an AF-P lens
- Taking pictures at low ambient temperatures

To ensure that you get the most from rechargeable Nikon EN-EL15b batteries:

- Keep the battery contacts clean. Soiled contacts can reduce battery performance.
 - Use batteries immediately after charging. Batteries will lose their charge if left unused.
- 1 EN-EL15a/EN-EL15 batteries can also be used. Note, however, that fewer pictures may sometimes be taken on a single charge with the EN-EL15 than with an EN-EL15b/EN-EL15a.
 - 2 Lens cycled from infinity to minimum range and one photograph taken at default settings once every 30 s. Live view not used. Measured at 23 °C/73.4 °F (± 2 °C/3.6 °F) with an AF-S NIKKOR 24–120mm f/4G ED VR lens. Figures are for a 32 GB SanDisk SD UHS-II memory card (SDSDXPK-032G-JNJIP – 32GB, measured in September 2019).
 - 3 Image quality set to JPEG normal, image size set to large, shutter speed $1/250$ s, focus cycled from infinity to minimum range three times after shutter-release button has been pressed halfway for 3 s; six shots are then taken in succession and monitor turned on for 5 s and then turned off; no operations performed until stand-by timer has expired. The cycle is then repeated. Measured at 23 °C/73.4 °F (± 2 °C/3.6 °F) with an AF-S NIKKOR 70–200mm f/2.8E FL ED VR lens (VR off). Figures are for a 32 GB SanDisk SD UHS-II memory card (SDSDXPK-032G-JNJIP – 32GB, measured in September 2019).

4 Actual battery endurance as measured under conditions specified by the Camera and Imaging Products Association (CIPA). Measured at 23 °C/73.4 °F (± 2 °C/3.6 °F) with an AF-S NIKKOR 24–120mm f/4G ED VR lens. Figures are for a 32 GB SanDisk SD UHS-II memory card (SDSDXPK-032G-JNJIP – 32GB, measured in September 2019).

Measurement performed at default settings.

- Each shot can be up to 29 minutes 59 seconds in length.
- Each shot can be up to 4 GB in size.
- If camera temperature rises, recording may end before maximum length or size is reached.

Trademarks and Licenses

- The SD, SDHC, and SDXC logos are trademarks of SD-3C, LLC.
- Windows is either a registered trademark or a trademark of Microsoft Corporation in the United States and/or other countries.
- Apple®, App Store®, the Apple logos, iPhone®, iPad®, iPod touch®, Mac, macOS, and OS X are trademarks of Apple Inc. registered in the U.S. and/or other countries.
- Android, Google Play and the Google Play logo are trademarks of Google LLC. The Android robot is reproduced or modified from work created and shared by Google and used according to terms described in the Creative Commons 3.0 Attribution License.
- IOS is a trademark or registered trademark of Cisco Systems, Inc., in the United States and/or other countries and is used under license.
- HDMI, the HDMI logo and High-Definition Multimedia Interface are trademarks or registered trademarks of HDMI Licensing, LLC.

HDMI

- The Bluetooth® word mark and logo are registered trademarks owned by Bluetooth SIG, Inc., and any use of such marks by Nikon is under license.
- Wi-Fi and the Wi-Fi logo are trademarks or registered trademarks of the Wi-Fi Alliance.
- All other trade names mentioned in this manual or the other documentation provided with your Nikon product are trademarks or registered trademarks of their respective holders.

Use of the Made for Apple badge means that an accessory has been designed to connect specifically to the Apple products identified in the badge, and has been certified by the developer to meet Apple performance standards. Apple is not responsible for the operation of this device or its compliance with safety and regulatory standards. Please note that the use of this accessory with an Apple product may affect wireless performance.

✔ FreeType License (FreeType2)

Portions of this software are copyright © 2012 The FreeType Project (<https://www.freetype.org>). All rights reserved.

✔ MIT License (HarfBuzz)

Portions of this software are copyright © 2018 The HarfBuzz Project (<https://www.freedesktop.org/wiki/Software/HarfBuzz>). All rights reserved.

☑ Unicode® Character Database License (Unicode® Character Database)

The software for this product uses the Unicode® Character Database License open-source software. The terms of the software license are as follows:

COPYRIGHT AND PERMISSION NOTICE

Copyright © 1991-2019 Unicode, Inc. All rights reserved.

Distributed under the Terms of Use in

<https://www.unicode.org/copyright.html>.

Permission is hereby granted, free of charge, to any person obtaining a copy of the Unicode data files and any associated documentation (the "Data Files") or Unicode software and any associated documentation (the "Software") to deal in the Data Files or Software without restriction, including without limitation the rights to use, copy, modify, merge, publish, distribute, and/or sell copies of the Data Files or Software, and to permit persons to whom the Data Files or Software are furnished to do so, provided that either

- (i) this copyright and permission notice appear with all copies of the Data Files or Software, or
- (ii) this copyright and permission notice appear in associated Documentation.

THE DATA FILES AND SOFTWARE ARE PROVIDED "AS IS", WITHOUT WARRANTY OF ANY KIND, EXPRESS OR IMPLIED, INCLUDING BUT NOT LIMITED TO THE WARRANTIES OF MERCHANTABILITY, FITNESS FOR A PARTICULAR PURPOSE AND NON-INFRINGEMENT OF THIRD PARTY RIGHTS.

IN NO EVENT SHALL THE COPYRIGHT HOLDER OR HOLDERS INCLUDED IN THIS NOTICE BE LIABLE FOR ANY CLAIM, OR ANY SPECIAL INDIRECT OR CONSEQUENTIAL DAMAGES, OR ANY DAMAGES WHATSOEVER RESULTING FROM LOSS OF USE, DATA OR PROFITS, WHETHER IN AN ACTION OF CONTRACT, NEGLIGENCE OR OTHER TORTIOUS ACTION, ARISING OUT OF OR IN CONNECTION WITH THE USE OR PERFORMANCE OF THE DATA FILES OR SOFTWARE.

Except as contained in this notice, the name of a copyright holder shall not be used in advertising or otherwise to promote the sale, use or other dealings in these Data Files or Software without prior written authorization of the copyright holder.

☑ AVC Patent Portfolio License

THIS PRODUCT IS LICENSED UNDER THE AVC PATENT PORTFOLIO LICENSE FOR THE PERSONAL AND NON-COMMERCIAL USE OF A CONSUMER TO (i) ENCODE VIDEO IN COMPLIANCE WITH THE AVC STANDARD ("AVC VIDEO") AND/OR (ii) DECODE AVC VIDEO THAT WAS ENCODED BY A CONSUMER ENGAGED IN A PERSONAL AND NONCOMMERCIAL ACTIVITY AND/OR WAS OBTAINED FROM A VIDEO PROVIDER LICENSED TO PROVIDE AVC VIDEO. NO LICENSE IS GRANTED OR SHALL BE IMPLIED FOR ANY OTHER USE. ADDITIONAL INFORMATION MAY BE OBTAINED FROM MPEG LA, L.L.C. SEE

<https://www.mpegla.com>

Notices

Notices for Customers in the U.S.A.

The Battery Charger

IMPORTANT SAFETY INSTRUCTIONS—SAVE THESE INSTRUCTIONS

DANGER—TO REDUCE THE RISK OF FIRE OR ELECTRIC SHOCK, CAREFULLY FOLLOW THESE INSTRUCTIONS

For connection to a supply not in the U.S.A., use an attachment plug adapter of the proper configuration for the power outlet if needed. This power unit is intended to be correctly oriented in a vertical or floor mount position.

Federal Communications Commission (FCC) Radio Frequency Interference Statement

This equipment has been tested and found to comply with the limits for a Class B digital device, pursuant to Part 15 of the FCC rules. These limits are designed to provide reasonable protection against harmful interference in a residential installation. This equipment generates, uses, and can radiate radio frequency energy and, if not installed and used in accordance with the instructions, may cause harmful interference to radio communications. However, there is no guarantee that interference will not occur in a particular installation. If this equipment does cause harmful interference to radio or television reception, which can be determined by turning the equipment off and on, the user is encouraged to try to correct the interference by one or more of the following measures:

- Reorient or relocate the receiving antenna.
- Increase the separation between the equipment and receiver.
- Connect the equipment into an outlet on a circuit different from that to which the receiver is connected.
- Consult the dealer or an experienced radio/television technician for help.



Nikon
D780

CAUTIONS

Modifications

The FCC requires the user to be notified that any changes or modifications made to this device that are not expressly approved by Nikon Corporation may void the user's authority to operate the equipment.

Interface Cables

Use the interface cables sold or provided by Nikon for your equipment. Using other interface cables may exceed the limits of Class B Part 15 of the FCC rules.

Nikon Inc., 1300 Walt Whitman Road,
Melville, New York 11747-3064, U.S.A.
Tel.: 631-547-4200

Power Cable

At voltages over AC 125 V (U.S.A. only): The power cable must be rated for the voltage in use, be at least AWG no. 18 gauge, and have SVG insulation or better with a NEMA 6P-15 plug rated for AC 250 V 15 A.

Notice for Customers in Canada

CAN ICES-3 B / NMB-3 B

Notices for Customers in Europe

CAUTION: RISK OF EXPLOSION IF BATTERY IS REPLACED BY AN INCORRECT TYPE. DISPOSE OF USED BATTERIES ACCORDING TO THE INSTRUCTIONS.

This symbol indicates that electrical and electronic equipment is to be collected separately.



The following apply only to users in European countries:

- This product is designated for separate collection at an appropriate collection point. Do not dispose of as household waste.
- Separate collection and recycling helps conserve natural resources and prevent negative consequences for human health and the environment that might result from incorrect disposal.
- For more information, contact the retailer or the local authorities in charge of waste management.

This symbol on the battery indicates that the battery is to be collected separately.



The following apply only to users in European countries:

- All batteries, whether marked with this symbol or not, are designated for separate collection at an appropriate collection point. Do not dispose of as household waste.
- For more information, contact the retailer or the local authorities in charge of waste management.

Bluetooth and Wi-Fi (Wireless LAN)

This product is controlled by the United States Export Administration Regulations (EAR). The permission of the United States government is not required for export to countries other than the following, which as of this writing are subject to embargo or special controls: Cuba, Iran, North Korea, Sudan, and Syria (list subject to change).

The use of wireless devices may be prohibited in some countries or regions. Contact a Nikon-authorized service representative before using the wireless features of this product outside the country of purchase.

The Bluetooth transmitter in this device operates in the 2.4 GHz band.

Notice for Customers in the U.S.A. and Canada

This device complies with part 15 of FCC Rules and Innovation, Science and Economic Development Canada's licence-exempt RSSs. Operation is subject to the following two conditions: (1) this device may not cause harmful interference, and (2) this device must accept any interference received, including interference that may cause undesired operation.

FCC WARNING

The FCC requires the user to be notified that any changes or modifications made to this device that are not expressly approved by Nikon Corporation may void the user's authority to operate the equipment.

Compliance with FCC requirement 15.407(c)

Data transmission is always initiated by software, which is then passed down through the MAC, through the digital and analog baseband, and finally to the RF chip. Several special packets are initiated by the MAC. These are the only ways the digital baseband portion will turn on the RF transmitter, which it then turns off at the end of the packet. Therefore, the transmitter will be on only while one of the aforementioned packets is being transmitted. In other words, this device automatically discontinues transmission in case of either absence of information to transmit or operational failure.

Frequency Tolerance: ± 20 ppm

FCC Radio Frequency Interference Statement

Note: This equipment has been tested and found to comply with the limits for a Class B digital device, pursuant to part 15 of the FCC Rules. These limits are designed to provide reasonable protection against harmful interference in a residential installation. This equipment generates, uses and can radiate radio frequency energy and, if not installed and used in accordance with the instructions, may cause harmful interference to radio communications. However, there is no guarantee that interference will not occur in a particular installation. If this equipment does cause harmful interference to radio or television reception, which can be determined by turning the equipment off and on, the user is encouraged to try to correct the interference by one or more of the following measures:

- Reorient or relocate the receiving antenna.
- Increase the separation between the equipment and receiver.
- Connect the equipment into an outlet on a circuit different from that to which the receiver is connected.
- Consult the dealer or an experienced radio/TV technician for help.

Co-location

This transmitter must not be co-located or operated in conjunction with any other antenna or transmitter.

Nikon Inc., 1300 Walt Whitman Road, Melville, New York 11747-3064, U.S.A.
Tel.: 631-547-4200

FCC/ISED RF Exposure Statement

The available scientific evidence does not show that any health problems are associated with using low power wireless devices. There is no proof, however, that these low power wireless devices are absolutely safe. Low power Wireless devices emit low levels of radio frequency energy (RF) in the microwave range while being used. Whereas high levels of RF can produce health effects (by heating tissue), exposure of low-level RF that does not produce heating effects causes no known adverse health effects. Many studies of low-level RF exposures have not found any biological effects. Some studies have suggested that some biological effects might occur, but such findings have not been confirmed by additional research. This product has been tested and found to comply with FCC/ISED radiation exposure limits set forth for an uncontrolled environment and meets the FCC radio frequency (RF) Exposure Guidelines and RSS-102 of the ISED radio frequency (RF) Exposure rules. Please refer to the SAR test report that was uploaded to FCC website.

Compliance with RSS-247 Issue 2 §6.4

Data transmission is always initiated by software, which is then passed down through the MAC, through the digital and analog baseband, and finally to the RF chip. Several special packets are initiated by the MAC. These are the only ways the digital baseband portion will turn on the RF transmitter, which it then turns off at the end of the packet. Therefore, the transmitter will be on only while one of the aforementioned packets is being transmitted. In other words, this device automatically discontinues transmission in case of either absence of information to transmit or operational failure.

Notice for Customers in Canada

For indoor use only (5150-5350MHz).

Notice for Customers in Europe and in Countries Complying with the Radio Equipment Directive

Hereby, Nikon Corporation declares that the radio equipment type D780 is in compliance with Directive 2014/53/EU.



The full texts of the EU declarations of conformity are available at the following internet addresses:

https://imaging.nikon.com/support/pdf/DoC_N1722.pdf

Notice for Customers in Singapore

Trade Name: **Nikon**
Model: D780

This device complies with radio-frequency regulations. The content of certification labels not affixed to the device is given below.

Complies with
IMDA Standards
DA103423

Notice for Customers in Nigeria

Connection and use of this communications
equipment is permitted by the Nigerian
Communications Commission

Security

Although one of the benefits of this product is that it allows others to freely connect for the wireless exchange of data anywhere within its range, the following may occur if security is not enabled:

- Data theft: Malicious third-parties may intercept wireless transmissions to steal user IDs, passwords, and other personal information.
- Unauthorized access: Unauthorized users may gain access to the network and alter data or perform other malicious actions. Note that due to the design of wireless networks, specialized attacks may allow unauthorized access even when security is enabled.
- Unsecured networks: Connecting to open networks may result in unauthorized access. Use secure networks only.

Conformity Marking

The standards with which the camera complies can be viewed using the **Conformity marking** option in the setup menu.

Certificates

• Maroc/

المغرب

AGREE PAR L'ANRT MAROC

Numéro d'agrément : MR 20875 ANRT 2019

• México

IFETEL: RCPMU1M18-0171

1MW

La operación de este equipo está sujeta a las siguientes dos condiciones:

- (1) es posible que este equipo o dispositivo no cause interferencia perjudicial y
- (2) este equipo o dispositivo debe aceptar cualquier interferencia, incluyendo la que pueda causar su operación no deseada.

• Paraguay



CONATEL

Emap S.A. (Casa Nissei)

Avda Adrian Jara, Esq. Regimiento Piribebuy, Ciudad del Este, Paraguay.

Tel: 595 61 500 115

Fax: 595 61 500 115

• عُمان

Oman-TRA

D090024

R/8043/19

• الإمارات العربية المتحدة

TRA

REGISTERED No:

ER61596/18

DEALER No:

DA39487/15

Kit Lens Manual

Kit Lenses

AF-S NIKKOR 24–120mm f/4G ED VR Lens Manual

Note that lens kits may not be available in some countries or regions.

Parts of the Lens

The parts of the AF-S NIKKOR 24–120mm f/4G ED VR are listed below.

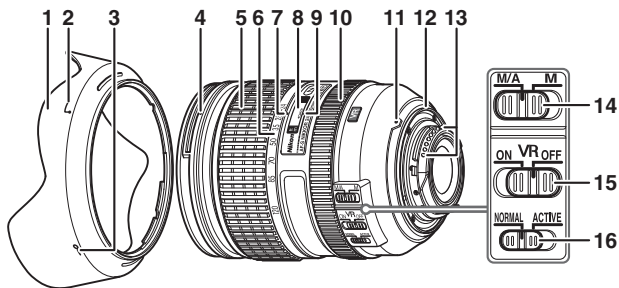

- 1 Lens hood
- 2 Lens hood alignment mark
- 3 Lens hood lock mark
- 4 Lens hood mounting mark
- 5 Zoom ring
- 6 Focal length scale
- 7 Focal length mark
- 8 Focus distance indicator

- 9 Focus distance mark
- 10 Focus ring
- 11 Lens mounting mark (☞ 23)
- 12 Rubber lens-mount gasket
- 13 CPU contacts
- 14 Focus-mode switch
- 15 Vibration reduction switch
- 16 Vibration reduction mode switch

■ Specifications

Type	Type G AF-S lens with built-in CPU and F mount
Focal length	24–120 mm
Maximum aperture	f/4
Lens construction	17 elements in 13 groups (including 2 ED lens elements, 3 aspherical lens elements, and lens elements with Nano Crystal Coat)
Angle of view	84° – 20° 20' (Nikon FX-format D-SLR cameras) 61° – 13° 20' (Nikon DX-format D-SLR cameras)
Focal length scale	Graduated in millimeters (24, 28, 35, 50, 70, 85, 120)
Distance information	Output to camera
Zoom	Manual zoom using independent zoom ring
Focusing	Nikon Internal Focusing (IF) System with autofocus controlled by Silent Wave Motor and separate focus ring for manual focus
Vibration reduction	Lens shift using voice coil motors (VCMs)
Focus distance indicator	0.45 m to infinity (∞)
Minimum focus distance	0.45 m (1.48 ft) from focal plane at all zoom positions

Diaphragm blades	9 (rounded diaphragm opening)
Diaphragm	Fully automatic
Aperture range	f/4–22
Metering system	Full aperture
Filter-attachment size	77 mm (P = 0.75 mm)
Dimensions	Approx. 84 mm maximum diameter × 103.5 mm (distance from camera lens mount flange)
Weight	Approx. 710 g (1 lb 9.1 oz)

- Nikon reserves the right to change the appearance and specifications of the hardware and software described in this manual at any time and without prior notice.
- Nikon will not be held liable for damages that may result from any mistakes that this manual may contain.



A series of horizontal lines for writing, consisting of 15 parallel lines spaced evenly down the page. A solid black rectangular block is positioned on the left side of the page, overlapping the first few lines.



A series of 18 horizontal lines spanning the width of the page, providing a template for handwriting practice.



A series of 15 horizontal lines for writing, starting from the top of the page and extending to the bottom. A solid black rectangular block is positioned on the left side of the page, partially overlapping the first few lines.

Warranty Terms - Nikon Europe Service Warranty

Dear Nikon Customer,

We thank you for your purchasing this Nikon product. Should your Nikon product require warranty service, please contact the dealer from whom it was purchased or a member of our authorized service network within the sales territory of Nikon Europe B.V. (e.g. Europe/Russia/others). See details under: <https://www.europe-nikon.com/support>

In order to avoid any unnecessary inconvenience, we advise you to read the user manuals carefully before contacting the dealer or our authorized service network.

Your Nikon equipment is guaranteed against any manufacturing defects for one full year from the date of original purchase. If during this period of guarantee the product proves defective due to improper material or workmanship, our authorized service network within the sales territory of Nikon Europe B.V. will, without charge for labor and parts, repair the product in the terms and conditions set as below. Nikon reserves the right (at its sole discretion) to replace or repair the product.

1. This warranty is only provided upon presentation of the completed warranty card and original invoice or purchase receipt indicating the date of purchase, product type and dealer's name, together with the product. Nikon reserves the right to refuse free-of-charge warranty service if the above documents cannot be presented or if the information contained in it is incomplete or illegible.

2. This warranty will not cover:

- necessary maintenance and repair or replacement of parts due to normal wear and tear.
- modifications to upgrade the product from its normal purpose as described in user manuals, without the prior written consent of Nikon.
- transport costs and all risks of transport relating directly or indirectly to the warranty of the products.
- any damage resulting from modifications or adjustments which may be made to the product, without the prior written consent of Nikon, in order to comply with local or national technical standards in force in any other country than the ones for which the product was originally designed and/or manufactured.

3. The warranty will not be applicable in the case of:

- damage caused by misuse including but not limited to failure to use the product for its normal purpose or according to the user instructions on the proper use and maintenance, and to installation or use of the product inconsistent with the safety standards in force in the country where it is used.
- damage caused by accidents including but not limited to lightning, water, fire, misuse or neglect.
- defacing, illegibility or removal of the model or serial number on the product.
- damage resulting from repairs or adjustments which have been conducted by unauthorized service organizations or persons.
- defects in any system into which the product is incorporated or with which it is used.

4. This service warranty does not affect the consumer's statutory rights under applicable national laws in force, nor the consumer's right against the dealer arising from their sales/ purchase contract.

Notice: An overview of all authorized Nikon Service Stations can be found online by following this Link
(URL = <https://www.europe-nikon.com/service/>).

Nikon Europe Service Warranty Card

Model name

Nikon D780

Serial No.

Purchase date

■ Name and address of customer

■ Dealer

■ Distributor

Nikon Europe B.V.
Tripolis 100, Burgerweeshuispad 101,
1076 ER Amsterdam, The Netherlands

■ Manufacturer

NIKON CORPORATION
Shinagawa Intercity Tower C, 2-15-3, Konan,
Minato-ku, Tokyo 108-6290 Japan

No reproduction in any form of this manual, in whole or in part (except for brief quotation in critical articles or reviews), may be made without written authorization from NIKON CORPORATION.

NIKON CORPORATION

© 2020 Nikon Corporation

AMA17061

Printed in Europe



SB9L01(11)
6MB46311-01