



KLARSTEIN

CHAL-TEC GmbH

Wallstraße 16,
10179 Berlin, Germany
WEEE-Nr.: DE 46906833

Importer for Great Britain:
Berlin Brands Group UK Limited
PO Box 42
272 Kensington High Street
London, W8 6ND
United Kingdom

Item-Nr.: 10045902

Description: Wine Cooler

Specifications:

Voltage/ Frequency: 220-240V/50Hz

Current: 1A

Power: 95W

Climate Class: N/ST

Storage Volume: 147L

Refrigerant (Weight): R600a/30g

Foaming Gas: Cyclopentane

Serial number: 1004590216023120001

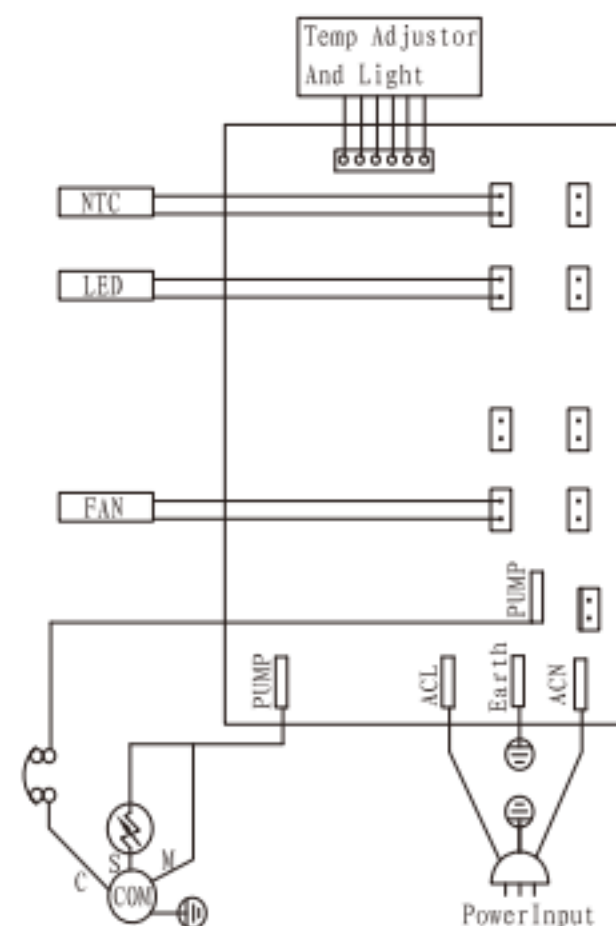

Electrocircuit Line Diagram