

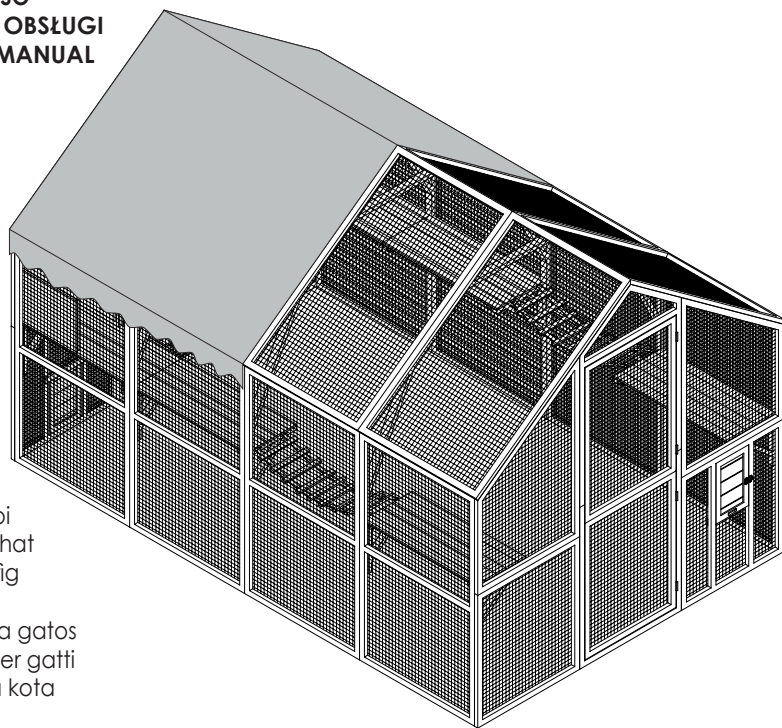

Kattenkooi

GEBRUIKERSHANDLEIDING
MODE D'EMPLOI
BEDIENUNGSANLEITUNG
USER'S MANUAL
MANUAL DE USUARIO
MANUALE D'USO
INSTRUKCJA OBSŁUGI
ANVÄNDARMANUAL



NL: Kattenkooi
FR: Cage à chat
DE: Katzenkäfig
EN: Cat cage
ES: Jaula para gatos
IT: Gabbia per gatti
PL: Klatka dla kota
SE: Kattburar

Model: 88048 - 88205

Onderdelen / Comosants / Komponenten / Components
Componentes / Componenti / Podzespoły / Komponenter

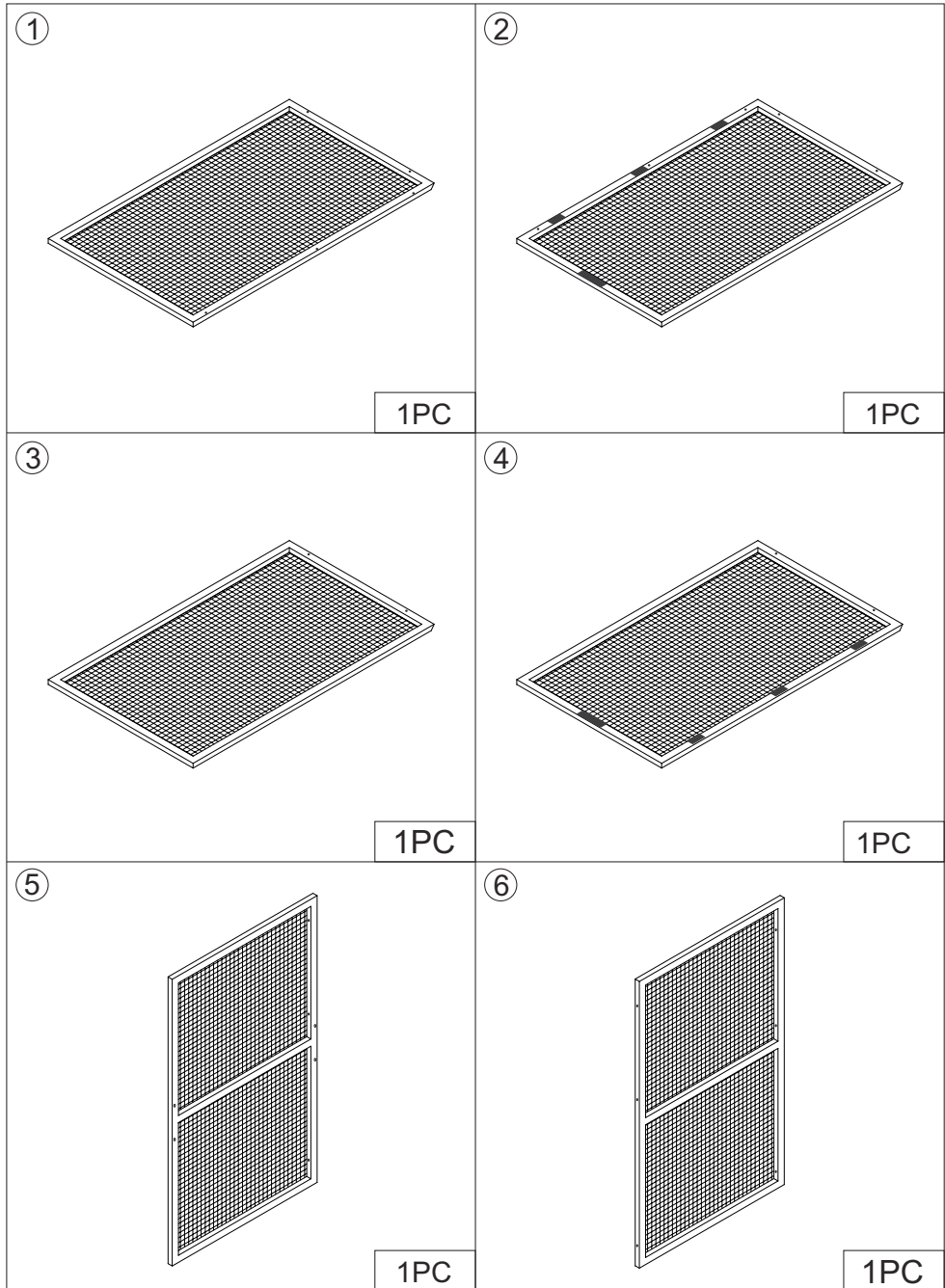

Onderdelen / Comosants / Komponenten / Components
Componentes / Componenti / Podzespoły / Komponenter

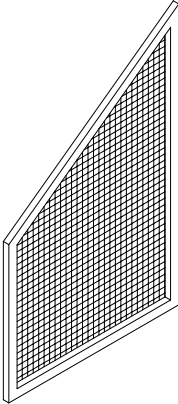
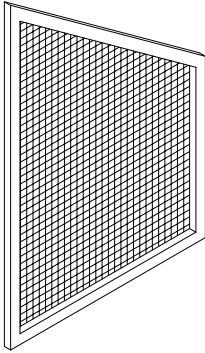
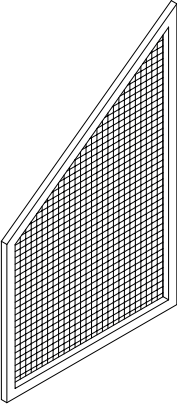
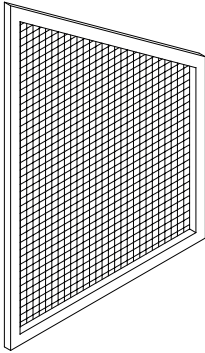
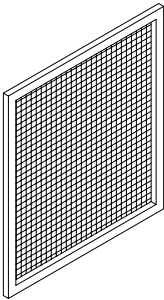
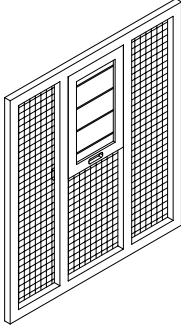
<p>⑦</p>  <p>1PC</p>	<p>⑧</p>  <p>1PC</p>
<p>⑨</p>  <p>1PC</p>	<p>⑩</p>  <p>1PC</p>
<p>⑪</p>  <p>1PC</p>	<p>⑫</p>  <p>1PC</p>

Onderdelen / Comosants / Komponenten / Components
Componentes / Componenti / Podzespoły / Komponenter

13

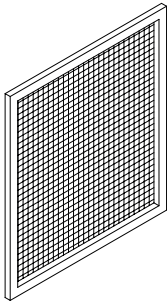

1PC

14

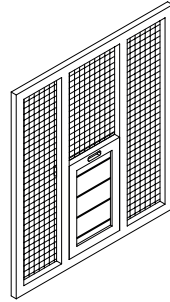

1PC

15

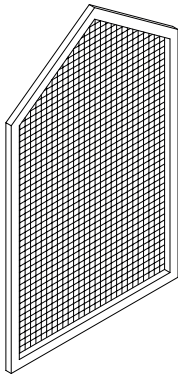

1PC

16

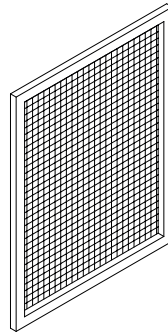

1PC

17

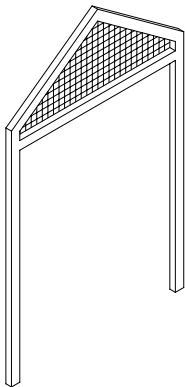

1PC

18

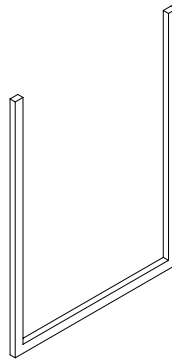

1PC

Onderdelen / Comosants / Komponenten / Components
Componentes / Componenti / Podzespoły / Komponenter

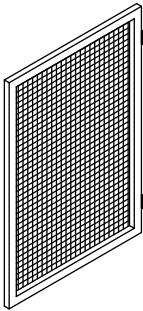
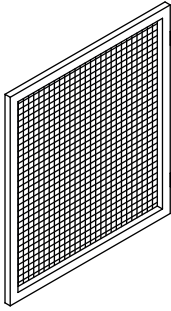
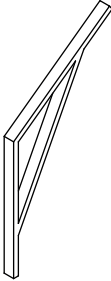
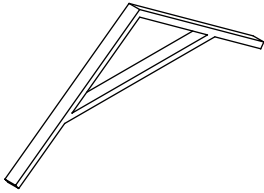
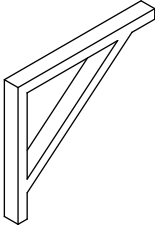
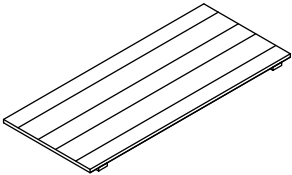
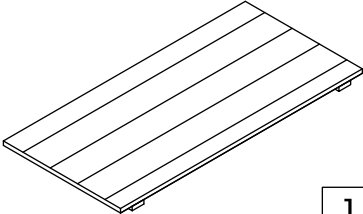
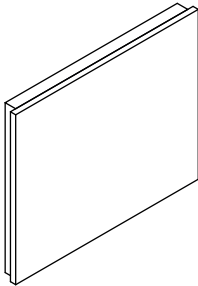
<p>19</p>  <p>1PC</p>	<p>20</p>  <p>1PC</p>
<p>21</p>  <p>6PCS</p>	<p>22</p>  <p>3PCS</p>
<p>23</p>  <p>10PCS</p>	<p>24</p>  <p>6PCS</p>
<p>25</p>  <p>1PC</p>	<p>26</p>  <p>4PCS</p>



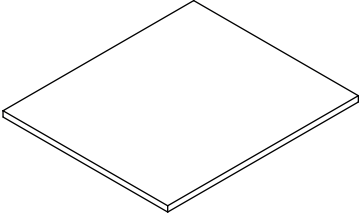
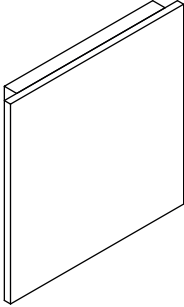
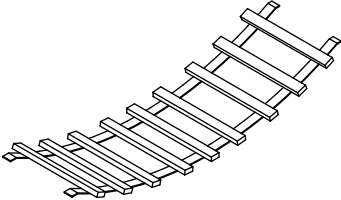
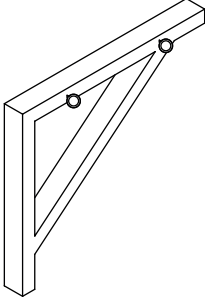
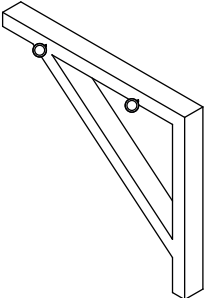
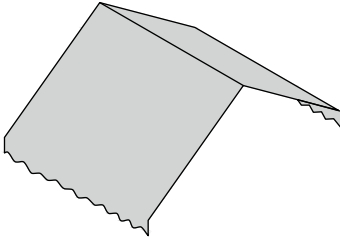
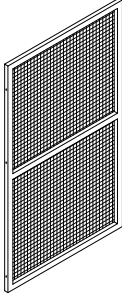
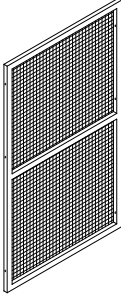

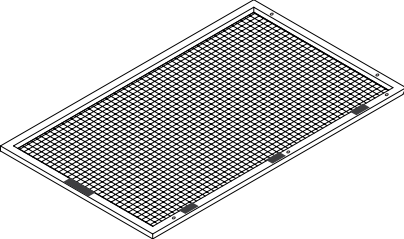
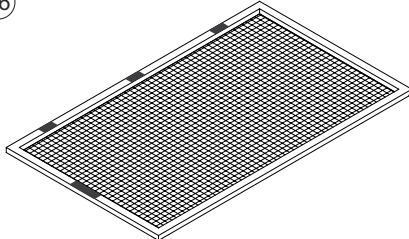
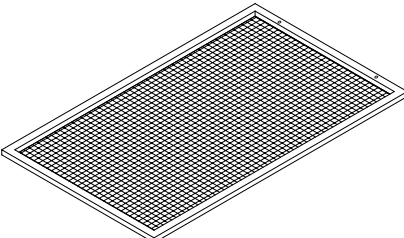
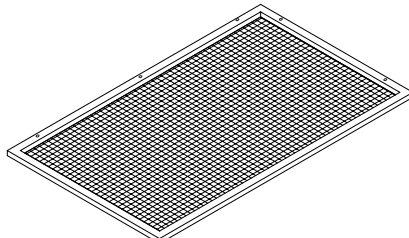
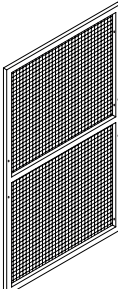
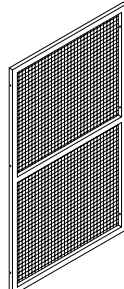
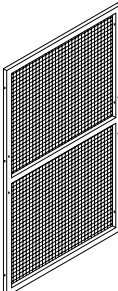
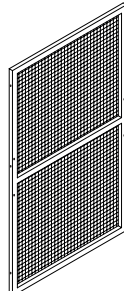

Onderdelen / Comosants / Komponenten / Components
Componentes / Componenti / Podzespoły / Komponenter

<p>27</p>  <p>2 PCS</p>	<p>28</p>  <p>2 PCS</p>
<p>29</p>  <p>2 PCS</p>	<p>30</p>  <p>2 PCS</p>
<p>31</p>  <p>2 PCS</p>	<p>32</p>  <p>1 PC</p>
<p>33</p>  <p>1 PC</p>	<p>34</p>  <p>1 PC</p>

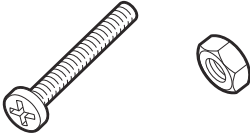
Onderdelen / Comosants / Komponenten / Components
Componentes / Componenti / Podzespoły / Komponenter

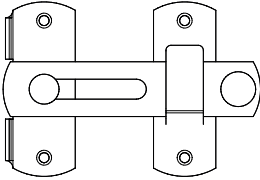
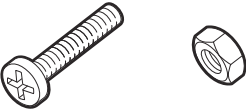

<p>35</p>  <p>1PC</p>	<p>36</p>  <p>1PC</p>
<p>37</p>  <p>1PC</p>	<p>38</p>  <p>1PC</p>
<p>39</p>  <p>1PC</p>	<p>40</p>  <p>1PC</p>
<p>41</p>  <p>1PC</p>	<p>42</p>  <p>1PC</p>

Onderdelen / Composants / Komponenten / Components
Componentes / Componenti / Podzespoły / Komponenter



<p>A</p>  <p>M5.0x45mm</p> <p>28PCS</p>	<p>B</p>  <p>M5.0x65mm</p> <p>50PCS</p>
<p>C</p>  <p>M3.5x35mm</p> <p>92PCS</p>	<p>D</p>  <p>M3.5x20mm</p> <p>40PCS</p>
<p>E</p>  <p>M3.0x10mm</p> <p>24PCS</p>	<p>F</p>  <p>4PCS</p>
<p>G</p>  <p>M5.0x55mm</p> <p>16PCS</p>	<p>H</p>  <p>M3.5x25mm</p> <p>12PCS</p>

Montage / Etapes de l'assemblage / Schritte zur Montage / Assembly steps
 Pasos del montaje / Fasi di montaggio / Etapy montażu / Stęg för montering

1



E x 8pcs

F x 2pcs

2

	
A x 8pcs	

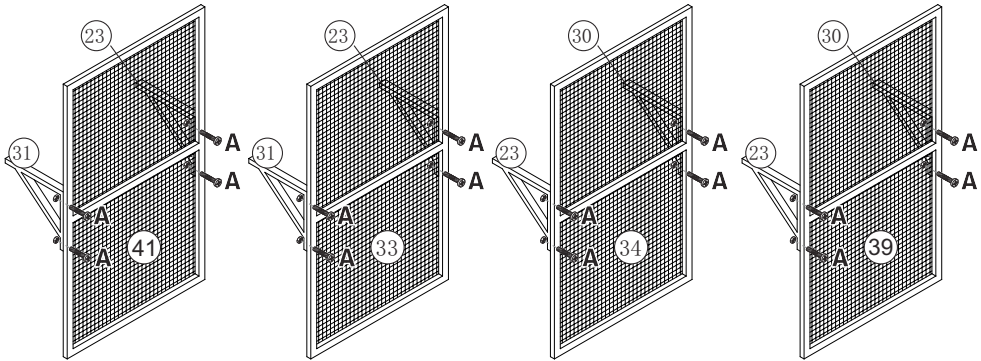
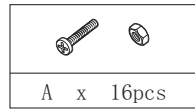
Montage / Etapes de l'assemblage / Schritte zur Montage / Assembly steps
 Pasos del montaje / Fasi di montaggio / Etapy montażu / Steg för montering

3



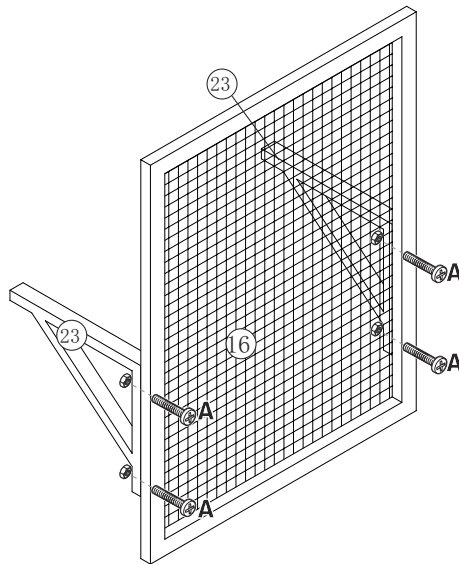
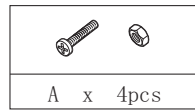

4



Montage / Etapes de l'assemblage / Schritte zur Montage / Assembly steps
 Pasos del montaje / Fasi di montaggio / Etapy montażu / Steg för montering

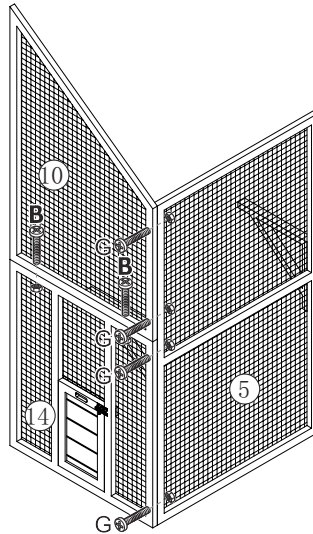
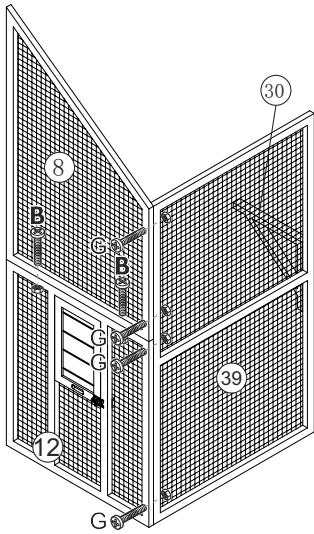

5

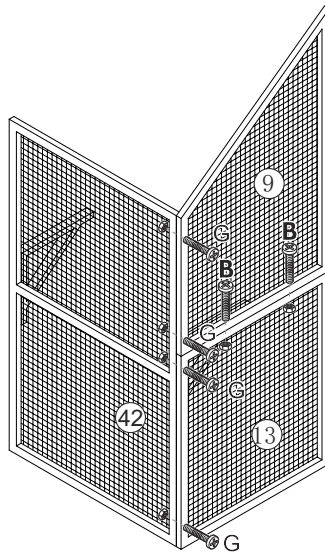
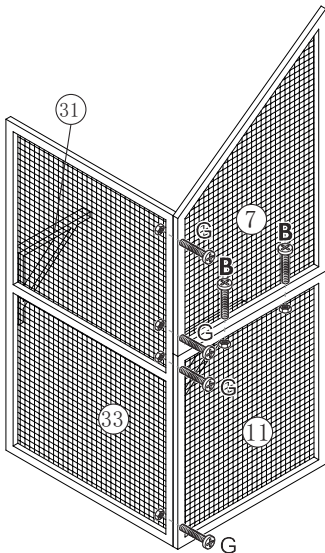

	
B	x 4pcs
	
G	x 8pcs

6



	
B	x 4pcs
	
G	x 8pcs

Montage / Etapes de l'assemblage / Schritte zur Montage / Assembly steps
 Pasos del montaje / Fasi di montaggio / Etapy montażu / Steg för montering

7

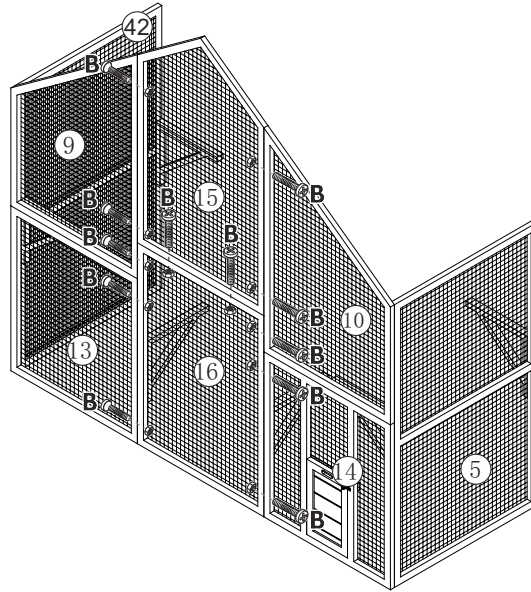

B x 12pcs

8

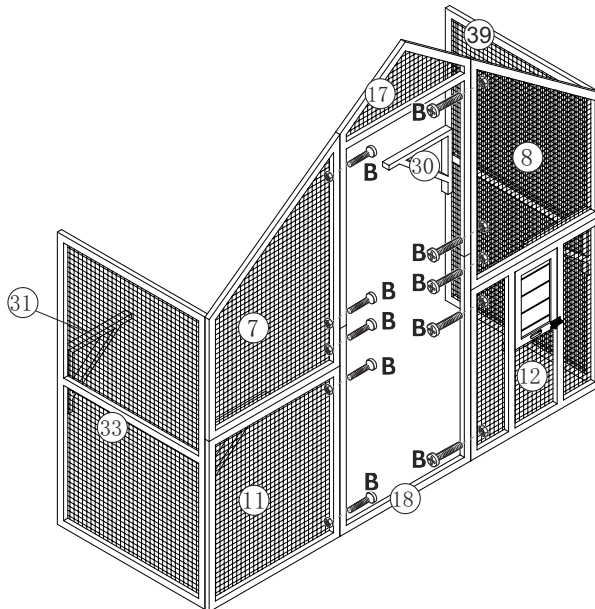



B x 10pcs

Montage / Etapes de l'assemblage / Schritte zur Montage / Assembly steps
 Pasos del montaje / Fasi di montaggio / Etapy montażu / Steg för montering

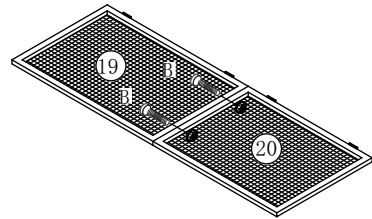
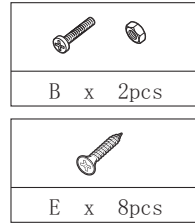
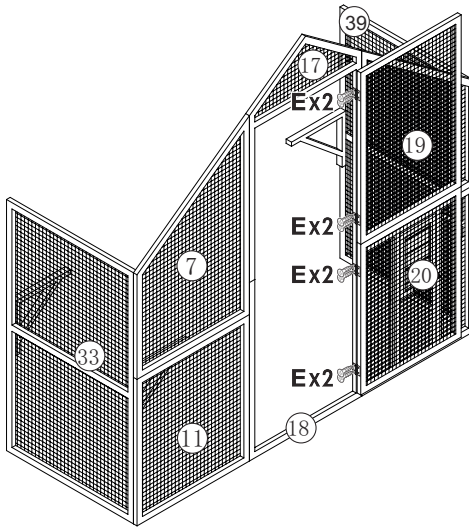
9

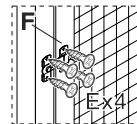
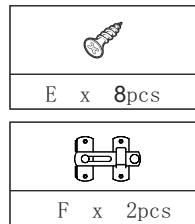
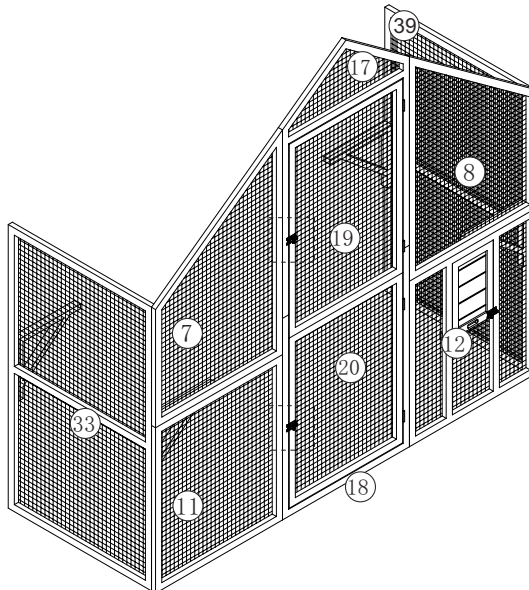

10



Montage / Etapes de l'assemblage / Schritte zur Montage / Assembly steps
 Pasos del montaje / Fasi di montaggio / Etapy montażu / Steg för montering

11

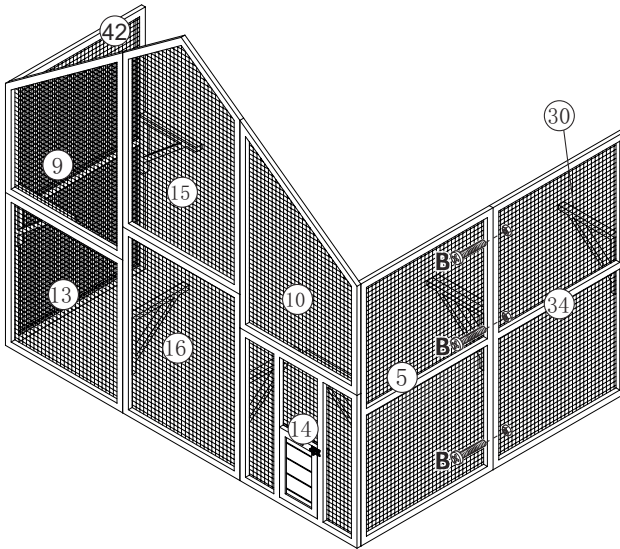
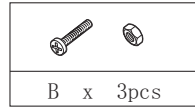

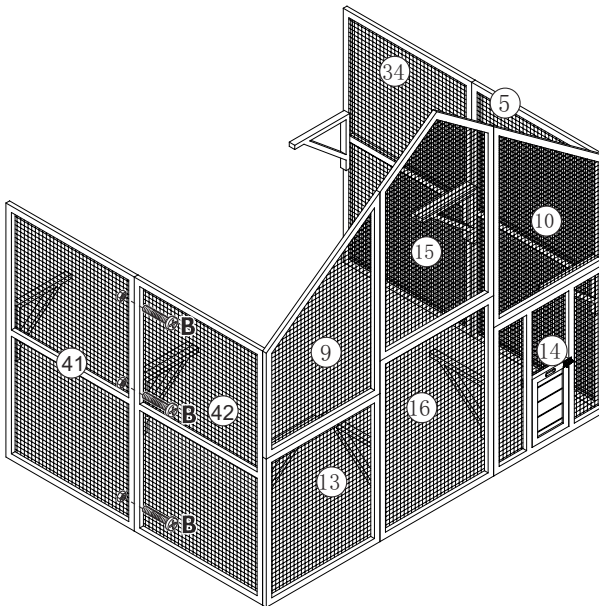
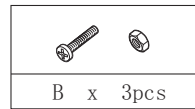

12

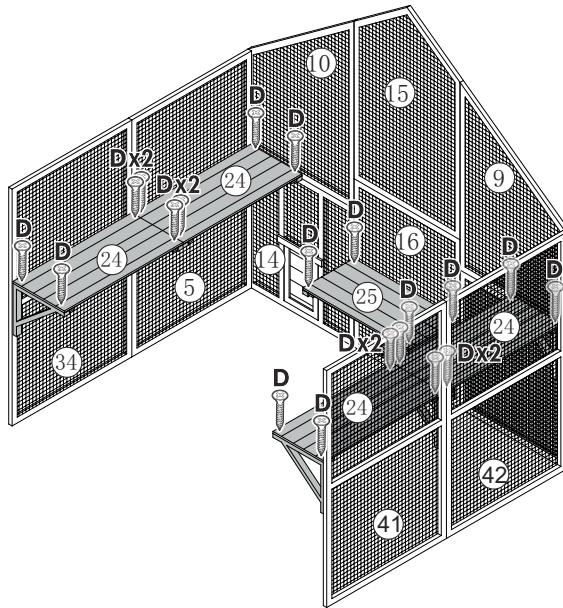

Montage / Etapes de l'assemblage / Schritte zur Montage / Assembly steps
 Pasos del montaje / Fasi di montaggio / Etapy montażu / Steg för montering

13



D x 20pcs

14

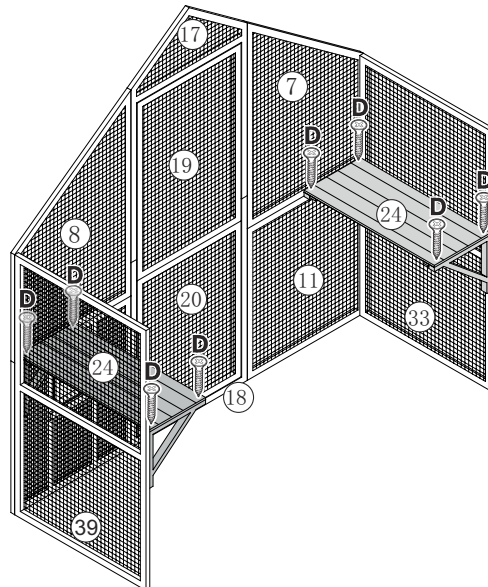



D x 8pcs

Montage / Etapes de l'assemblage / Schritte zur Montage / Assembly steps
Pasos del montaje / Fasi di montaggio / Etapy montażu / Steg för montering

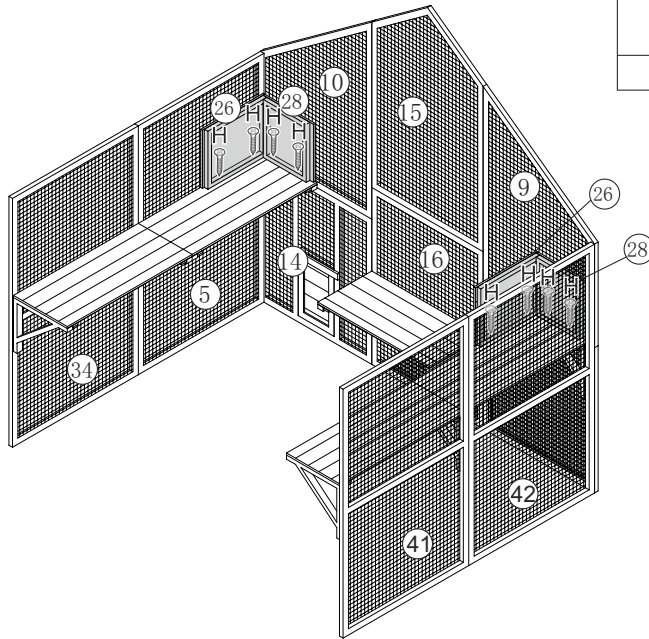
15

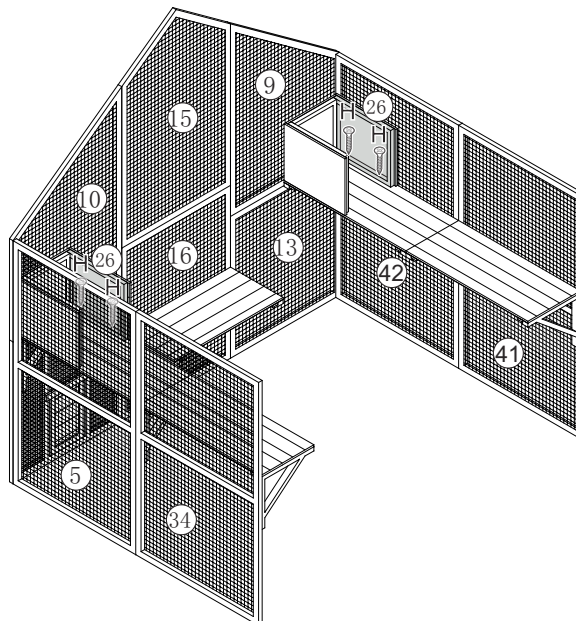

16



Montage / Etapes de l'assemblage / Schritte zur Montage / Assembly steps
 Pasos del montaje / Fasi di montaggio / Etapy montażu / Steg för montering

17

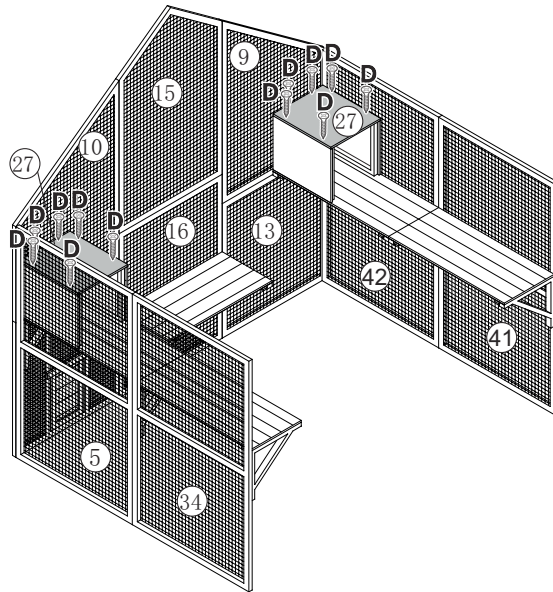

D x 12pcs

18

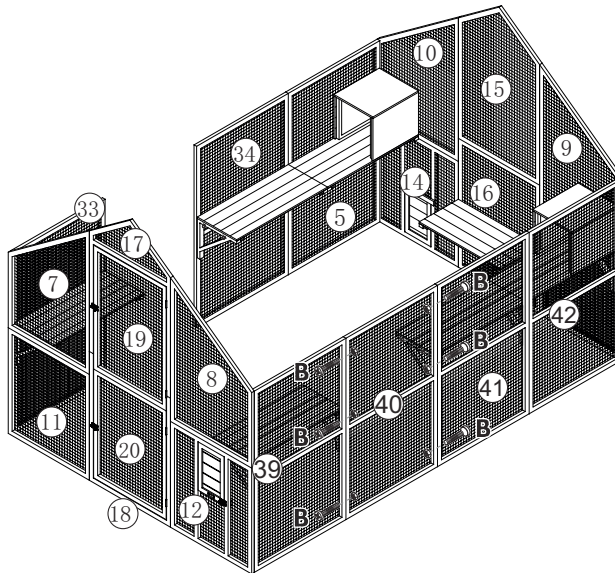

B x 6pcs

Montage / Etapes de l'assemblage / Schritte zur Montage / Assembly steps
 Pasos del montaje / Fasi di montaggio / Etapy montażu / Steg för montering

19

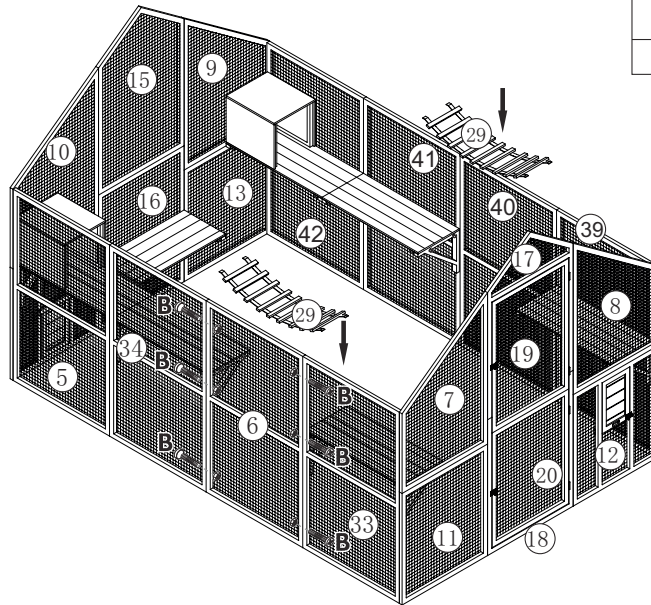

20

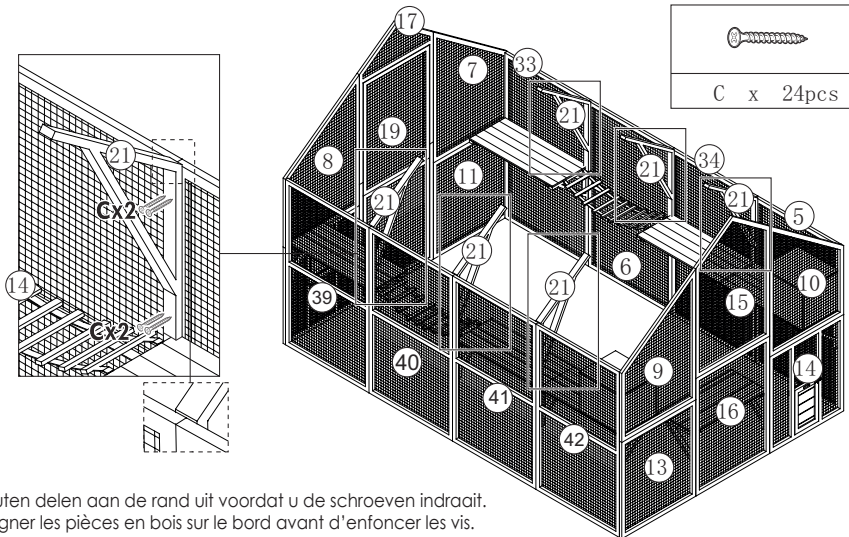

- NL. Lijn de houten delen aan de rand uit voordat u de schroeven indraait.
 FR. Veuillez aligner les pièces en bois sur le bord avant d'enfoncer les vis.
 DE. Bitte richten Sie die Holzteile am Rand aus, bevor Sie die Schrauben eindrehen.
 EN. Please align the wood parts at the edge before you drive the screws.
 ES. Alinee las piezas de madera en el borde antes de colocar los tornillos.
 IT. Si prega di allineare le parti in legno al bordo prima di avvitare le viti.
 PL. Przed wkręceniem śrub wyrównaj drewniane części na krawędziach.
 SE. Rikta in trädelarna i kanten innan du skruvar in skruvarna.

Montage / Etapes de l'assemblage / Schritte zur Montage / Assembly steps
 Pasos del montaje / Fasi di montaggio / Etapy montażu / Steg för montering

21

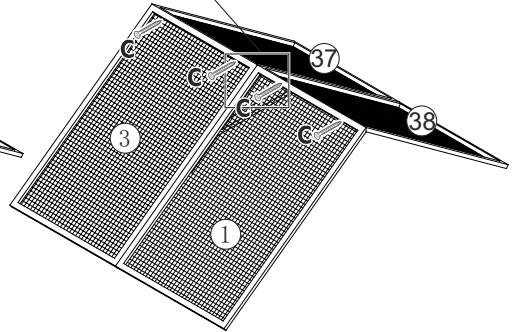
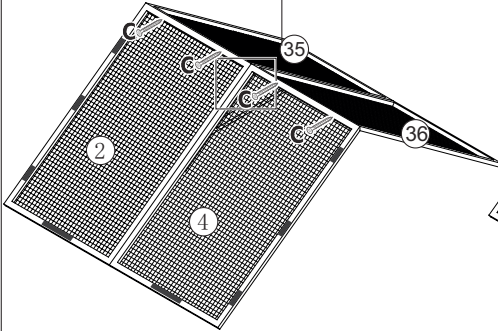
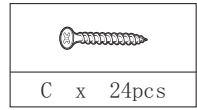
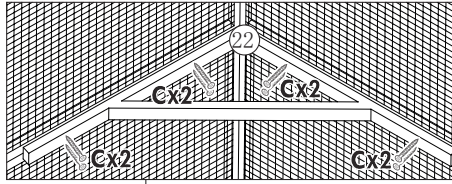

22

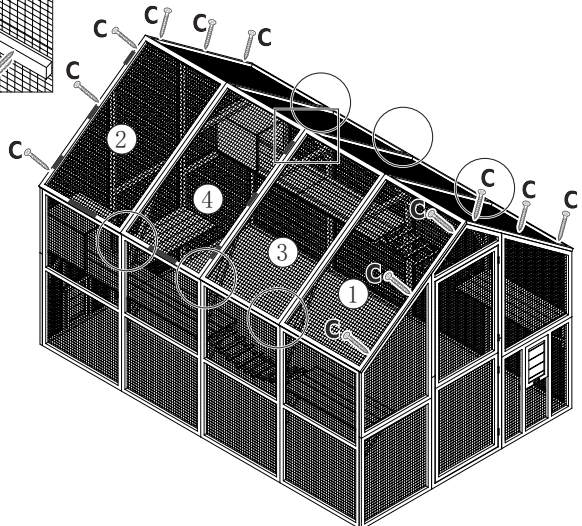
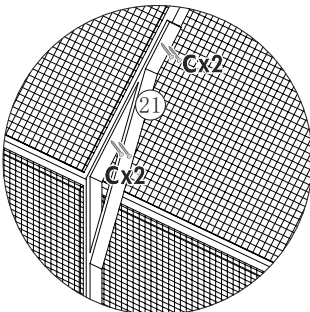
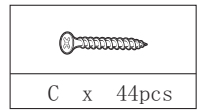
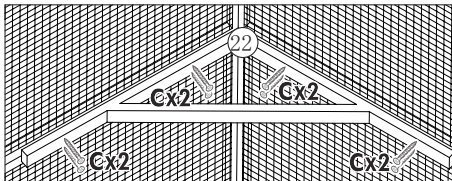

Montage / Etapes de l'assemblage / Schritte zur Montage / Assembly steps
Pasos del montaje / Fasi di montaggio / Etapy montażu / Steg för montering

23

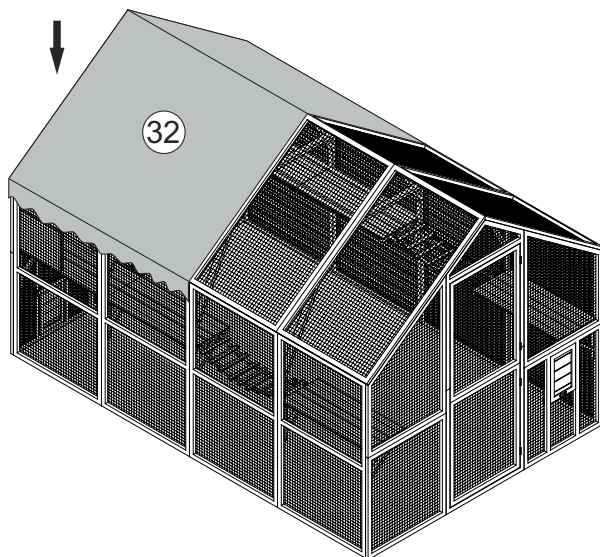

CONGRATULATIONS
YOU ARE DONE!



NUUESTRO EQUIPO MAXXTOOLS TE AYUDA CON:

- Preguntas sobre tu pedido
- Quejas
- Piezas y manuales

Si tiene alguna pregunta o queja, contáctenos y estaremos encantados de ayudarle.

IL NOSTRO TEAM MAXXTOOLS TI AIUTA CON:

- Domande sul tuo ordine
- Reclami
- Parti e manuali

In caso di domande o reclami, non esitate a contattarci e saremo felici di aiutarvi.

NASZ ZESPÓŁ SERWISOWY MAXXTOOLS POMOŻE CI:

- Pytania dotyczące zamówienia
- Reklamacje
- Części i instrukcje

Jeśli masz jakiegokolwiek pytania lub skargi, skontaktuj się z nami, a my z przyjemnością Ci pomożemy.

VÅRT SERVICETEAM MAXXTOOLS HJÄLPER DIG MED:

- Frågor om din beställning
- Klagomål
- Delar och manualer

Om du har några frågor eller klagomål, vänligen kontakta oss så hjälper vi dig gärna.



SCAN ME



TELEFONSUPPORT: +32 (0) 11 191391

Måndag till fredag - 9 - 17

Telefonkostnader kan variera beroende på din mobilabonnemang.

SERVICIO TELEFÓNICO: +32 (0) 11 191391

De lunes a viernes de 9 a.m. a 5 p.m.

Los costos telefónicos pueden variar según su suscripción móvil.

SERVIZIO TELEFONICO: +32 (0) 11 191391

Dal lunedì al venerdì - 9:00 - 17:00

I costi del telefono possono variare a seconda dell'abbonamento mobile.

WSPARCIE TELEFONICZNE: +32 (0) 11 191391

Od poniedziałku do piątku w godz. 9-17

Opłaty za telefon mogą się różnić w zależności od abonamentu komórkowego.

MaxxTools

The biggest online selection of home, garden, pet & toys.

support@maxxtools.be
www.maxxpet.be



ONS MAXXTOOLS TEAM HELPT JE MET:

- Vragen over je bestelling
- Klachten
- Onderdelen en handleidingen

Heb je vragen of klachten contacteer ons en we helpen je graag verder.

NOTRE EQUIPE MAXXTOOLS VOUS AIDERA VOLONTIÈRE AUX CAS SUIVANTS:

- Questions sur votre commande
- Réclamations
- Pièces et manuels

Si vous avez des questions ou des plaintes, s'il vous plaît contactez-nous et nous serons heureux de vous aider.

OUR MAXXTOOLS SERVICE TEAM HELPS YOU WITH:

- Questions about your order
- Complaints
- Parts and manuals

If you have any questions or complaints, please contact us and we will be happy to help you.

UNSER MAXXTOOLS TEAM HILFT IHNEN GERNE BEI:

- Fragen zu Ihrer Bestellung
- Reklamationen
- Teile und Handbücher

Wenn Sie Fragen oder Beschwerden haben, wenden Sie sich bitte an uns. Wir helfen Ihnen gerne weiter.



SCAN ME



TELEFOONSERVICE: +32 (0) 11 191391

Maandag tot vrijdag - 9u - 17u
De telefoon kosten kunnen variëren afhankelijk van uw mobiel abonnement.

ASSISTANCE TÉLÉPHONIQUE: +32 (0) 11 191391

Du lundi au vendredi de 9h à 17h
Les frais de téléphone peuvent varier en fonction de votre abonnement mobile.

TELEPHONE SUPPORT: +32 (0) 11 191391

Monday to friday - 9 am - 5 pm
Phone charges may vary depending on your mobile subscription.

TELEFON-SERVICE: +32 (0) 11 191391

Montag bis freitag von 9 bis 17 Uhr
Die Telefonkosten können je nach Mobilfunkabonnement variieren.

MaxxTools

The biggest online selection of home, garden, pet & toys.

support@maxxtools.be
www.maxxpet.be