



40759/\*\*/16

Gebruiksaanwijzing

Notice d'emploi

Benutzerhandbuch

User manual

Manual de usuario

Manual do usuário



**PHILIPS**

Incl.

**A**



**B**

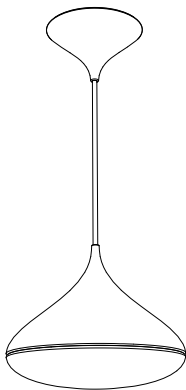

Excl.

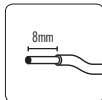
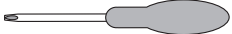
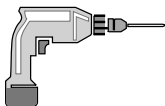

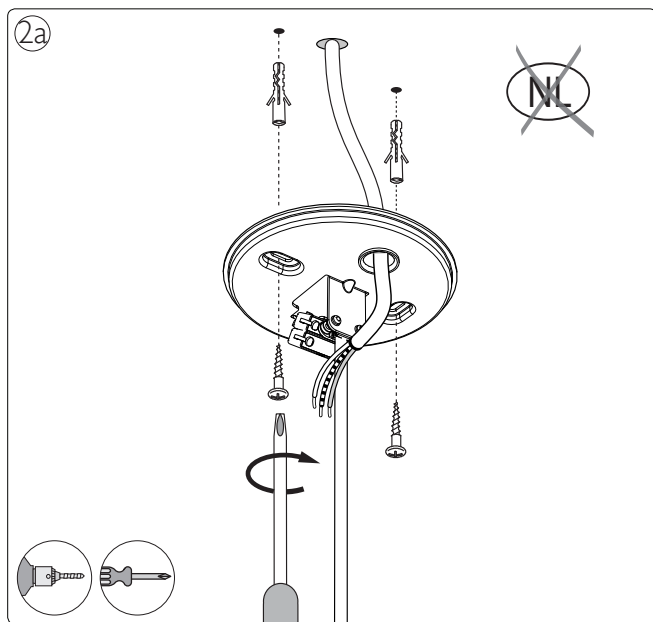
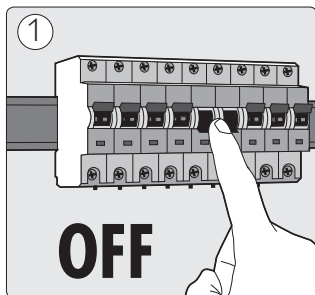

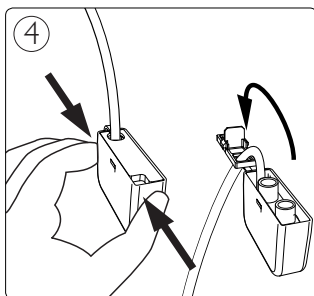
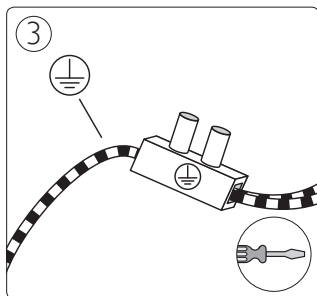
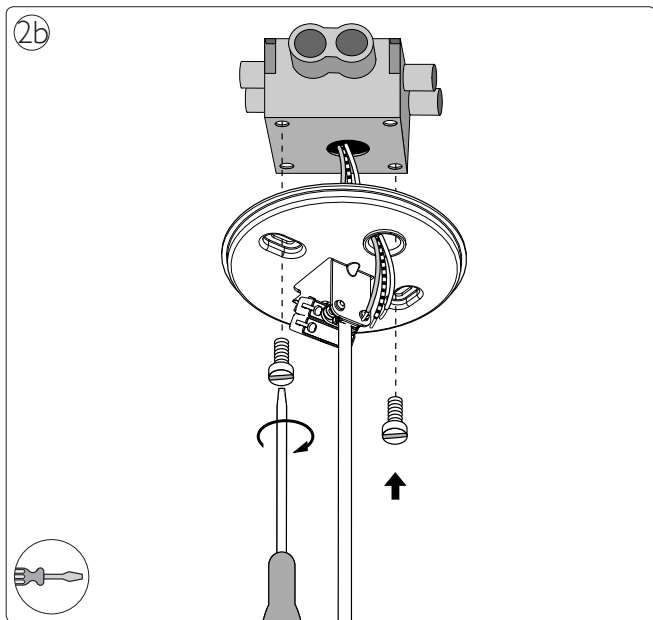

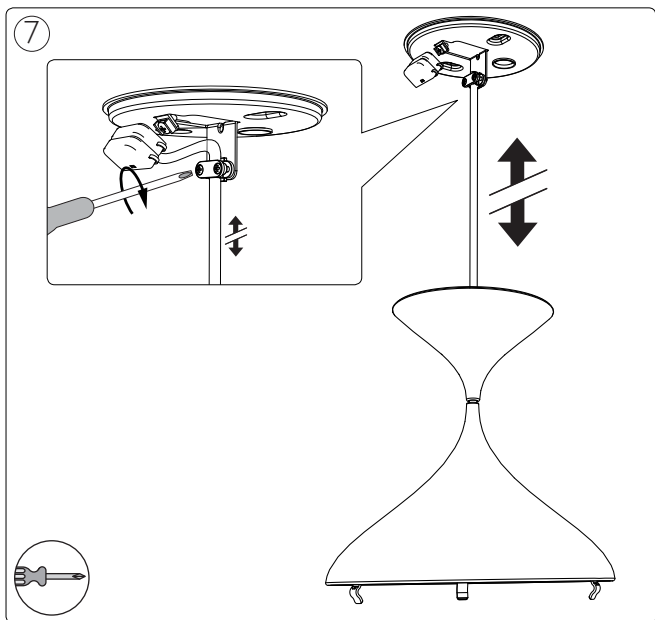
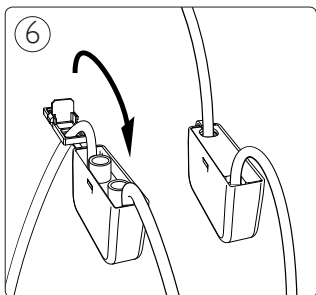
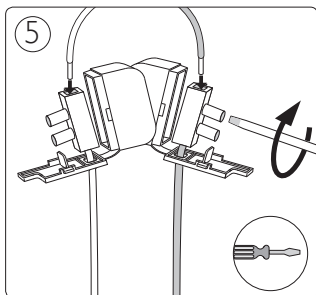

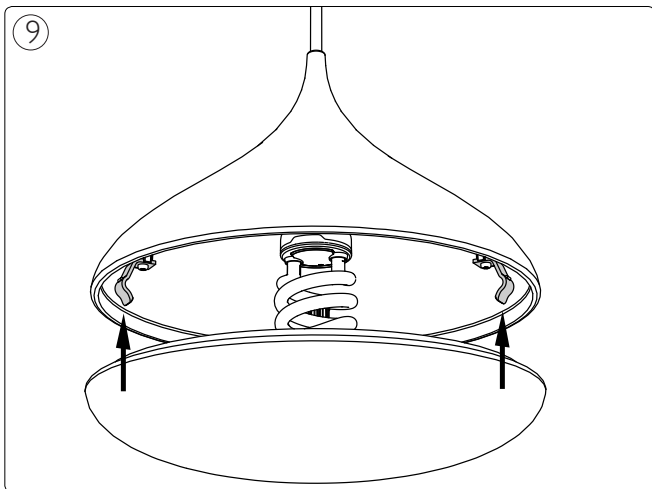
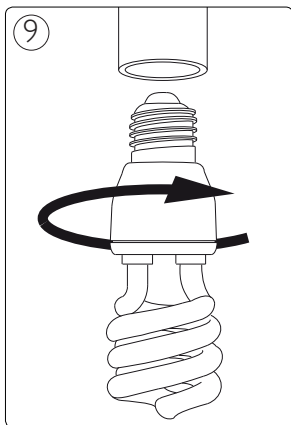
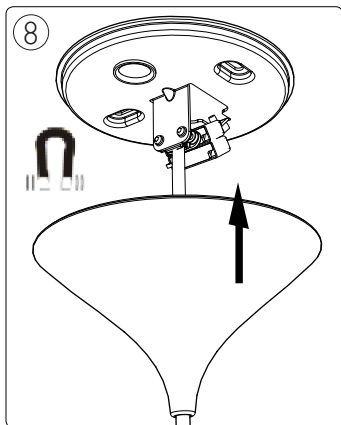





Philips Lighting Contact Centre  
Int. Business Reply Service  
I.B.R.S. / C.C.R.I. Numéro 10461  
5600 VB Eindhoven  
Pays-Bas / The Netherlands

[www.philips.com/homelighting](http://www.philips.com/homelighting)  
☎ +800 7445 4775

4404.018.28541  
Last update: 05/11/13