

Graphic Pen Tablet

Deco 03 Manual

Windows 10, 8, 7 and Mac OS X and above

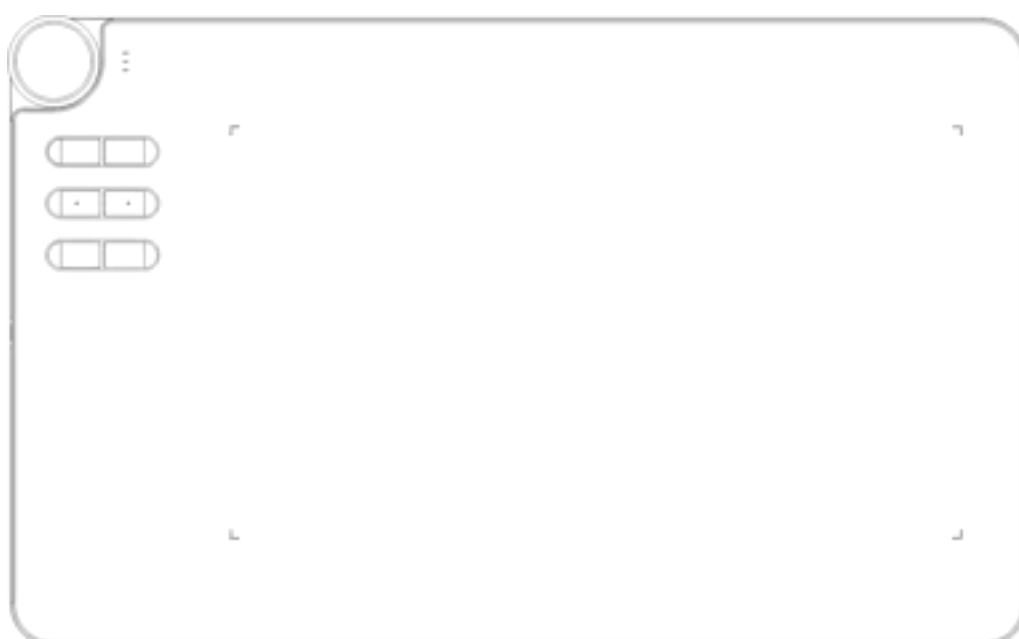

Safety Precautions

This manual uses the following symbols to ensure that the XP-PEN Tablet is used correctly and safely. Be sure to read and observe the Safety Precautions.



Do not use this product in a control system area that requires a high degree of safety and reliability.

In such a system, this product could negatively affect other electronic devices and could malfunction due to the effect of those devices.



Turn the power off in areas where use of electronic devices is prohibited.

Turn the power off your tablet when onboard an aircraft or in any other location where use of electronic devices is prohibited, otherwise it may negatively affect other electronic devices in the area.

Unplug the USB connector from this product and turn the power off.



Keep the product away from infants and young children.

Accessories to this gadget may present a choking hazard to small children. Keep all accessories away from infants and young children.



CAUTION

Do not place this product on unstable surfaces.

Avoid placing this product on unstable, tilted surfaces or any locations exposed to excessive vibrations. This may cause the tablet to fall or impact surfaces which can result in damage and/or malfunction to the tablet.

Do not place heavy objects on top of this product.

Do not place heavy objects on the product. Do not step on, or place your body weight on this product as this may cause damage.



Avoid extreme high or low-temperature exposure to the XP-Pen tablet.

Do not store this product in areas that drop below 5°C or above 40°C. Avoid locations with excessive temperature fluctuations. This may result in damage to the product and its components.



Do not disassemble

Do not disassemble or modify this product. Doing so may expose you to heat, fire, electric shock and injury. Disassembling the product will void your warranty.



Do not use alcohol for cleaning

Never use alcohol, thinner, benzene or other mineral solvents that may discolor and cause deterioration to the product.



Do not expose to water

Be cautious of water and all liquids that may be near the tablet. Exposure to water or liquid could damage the product.



CAUTION



Avoid placing metallic objects and especially magnetic objects on the tablet.

Placing metallic and/or magnetic objects on this product during operation may cause malfunction or permanent damage.



Do not strike the pen against hard objects.

Striking the pen against hard objects can cause damage to the pen.



Avoid gripping the pen too tightly, and DO NOT use excessive weight/pressure on the Express Key button and pen.

The stylus pen is a high-precision instrument. Avoid pressing too tightly on the Express Key button, and keep any objects from covering the pen to avoid potential damage. Keep the pen away from areas of high dust, contaminants, or any particulate matter that can affect or damage the pen.

Limitation of Liability

1. XP-Pen shall in no event be liable for damages resulting from fires or earthquakes, including those caused by third parties and those arising from user misuse, abuse or neglect.
2. XP-Pen shall in no event be liable for incidental damages-including but not limited to loss of business income, interruption of business activities, corruption or loss of data-that arise from use or failure to use this product correctly.
3. XP-Pen shall in no event be liable for damage resulting from uses not documented in this manual.
4. XP-Pen shall in no event be liable for damages or malfunction arising from the connection to other devices or use of third party software.

Contents

[I. Product Overview](#)

[Overview](#)

[Active area](#)

[II. Stylus](#)

[Overview](#)

[Pen tip replacement](#)

[III. Connecting the Deco 03](#)

[Wireless USB](#)

[Corded USB](#)

[Sleep mode](#)

[IV. Driver Installation](#)

[Windows](#)

[Mac](#)

[V. Driver Settings UI](#)

[Windows](#)

[Mac](#)

[VI. Driver Uninstallation](#)

[Windows](#)

[Mac](#)

[VII. FAQ](#)

{ I. Product Overview }

Overview

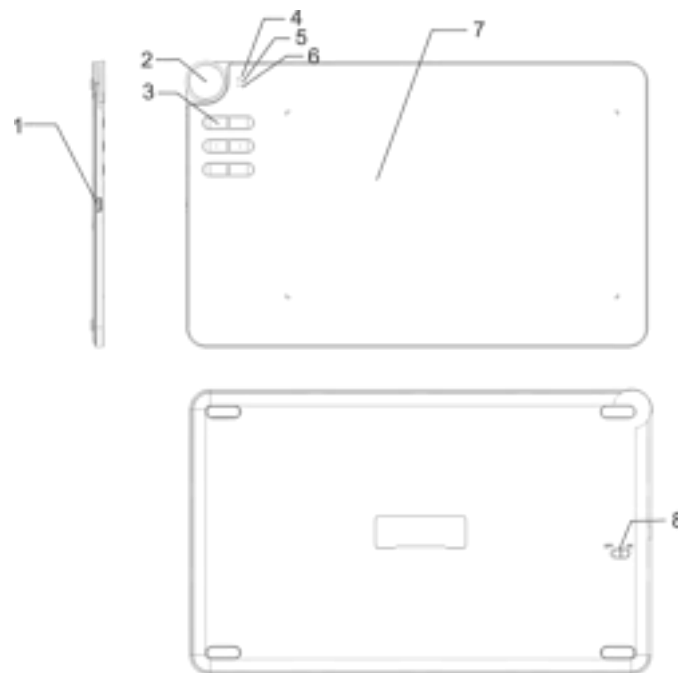

Figure 1. Overview

- {1}. Type-C port
- {2}. Roller key
- {3}. Shortcut keys
- {4}. Status indicator light
 - a. White, blinking: Stylus is in range, but not touching the working area.
 - b. White, solid: Stylus is touching the working area.
 - c. No light: Stylus is out of detection range.
- {5}. Wireless indicator light
 - a. Green light on: Tablet is connected via wireless USB.
 - b. Green light off: Tablet is not connected via wireless USB.
- {6}. Battery indicator light
 - a. Red, blinking: Tablet battery is low.
 - b. Blue: Tablet is connected and charging via corded USB.
 - c. Green: Tablet is fully charged.
 - d. Off: Tablet is not connected via corded USB and battery is sufficiently charged.
- {7}. Active area
- {8}. Power on/off button

Active area

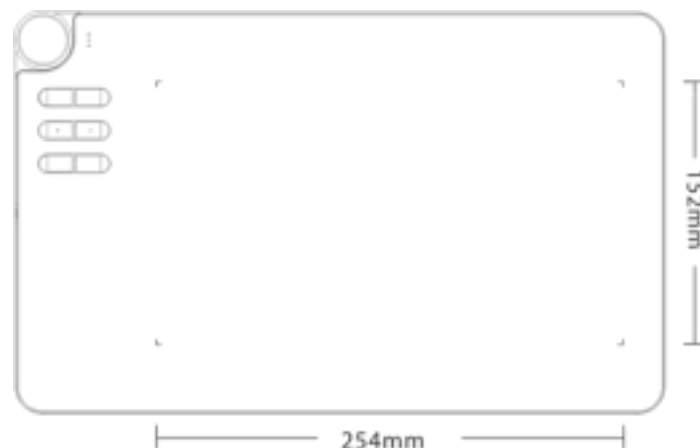

Figure 2. Active area

{ II. Stylus }

Overview



Image 2-1 Stylus

- {1}: Pen tip
- {2}: Barrel button 2
- {3}: Barrel button 1

NOTES:

- a. Barrel button functions can be customized in the tablet's driver settings.
- b. Stylus does not use a battery or require charging.

Pen Case, Pen stand, Pen tip, USB receiver and Pen clip hole



Image 2-2 Pen Case, Pen stand, Pen tip, USB receiver and Pen clip hole

- {1}: Pen clip
- {2}: USB receiver
- {3}: Pen clip hole
- {4}: Pen case
- {5}: Pen stand

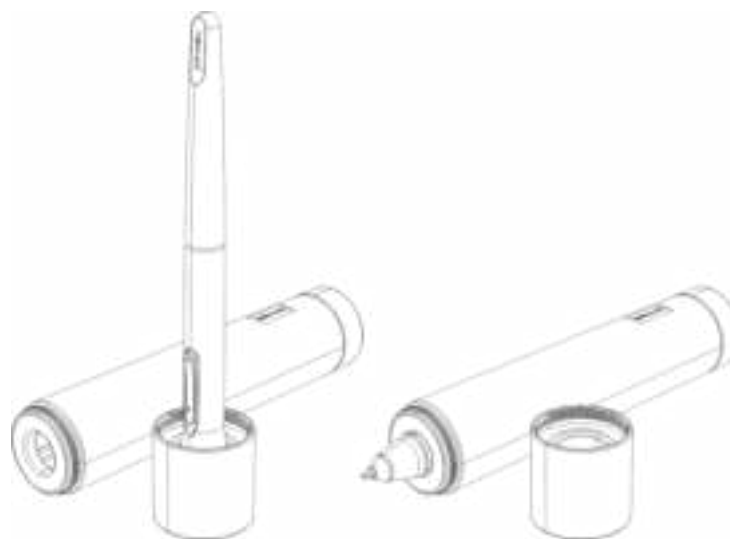

Image 2-3 Pen stand

Pen tip replacement

- (1). Twist the pen stand's top cover counter-clockwise to separate it from the pen stand.
Insert the stylus tip into the hole in its center. Tilt the stylus slightly so that the tip catches on the edge of the hole, then pull the stylus and pen stand apart to remove the pen tip.
- (2). Take a new pen tip from the inside of the pen stand.
- (3). Push the new pen tip straight into the stylus.

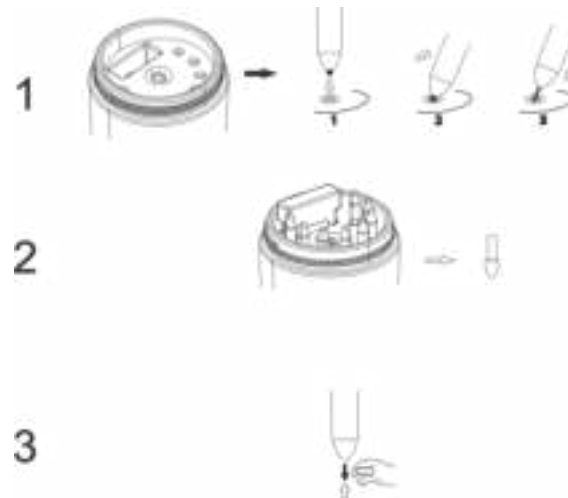

Figure 2-4 Pen tip replacement

{ III. Connecting the Deco 03 }

Wireless USB

- (1). With the Deco 03 switched "Off," insert the included USB wireless receiver into your computer's USB port.
- (2). Place the Deco 03 in range of the receiver.
- (3). Press and hold the <I> shortcut key while switching the Deco 03 "ON" to activate the tablet.
- (4). If successful, the Deco 03's green wireless indicator light will light up and remain on. If the wireless indicator light does not light up, repeat steps 1 and 3.

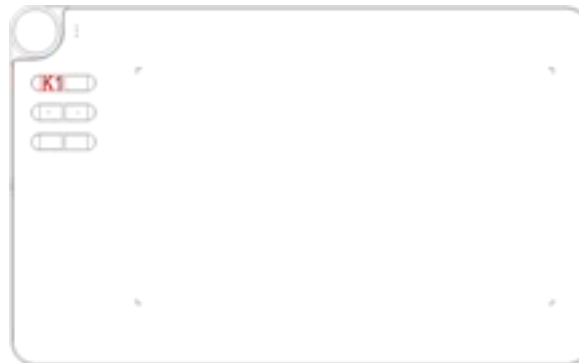

Figure 3-1 Wireless USB

Corded USB

- (1). Connect the Deco 03 to your computer with the included USB cable.
- (2). Switch the tablet on.

Sleep mode

When connected wirelessly, the Deco 03 will automatically enter "Sleep" mode after being idle for 30 minutes. The tablet can be woken up in two ways:

- Press any shortcut key.
- OR
- Turn the tablet off and back on with its power switch.

{ IV. Driver Installation }

Supported operating systems:

Windows 10, 8, 7

Mac OS X 10.8 or above

NOTES:

- (1). **Disable any antivirus or firewall software and close any non-essential background software before beginning the installation. Some software, such as OneDrive and Dropbox, may monopolize important files and prevent a successful installation. On Windows computers, check the system tray on the bottom-right of the screen and close any software unrelated to your computer hardware.**
- (2). **Uninstall any existing tablet software before attempting to install the Deco 03 driver. Other tablet drivers will conflict with the Deco 03 driver or prevent installation entirely.**
- (3). **You can download the latest driver version from the XP-Pen website (www.xp-pen.com). If you choose to download the driver from the website, be sure to extract the .zip file contents before running ".exe" or ".pkg."**

Windows

- (1). Connect the Deco 03 to your computer using the included USB cord.
- (2). Please download the Deco 03 latest driver from the support section of our website, www.xp-pen.com
- (3). Extract the ".zip" file contents before running ".exe".
- (4). After a successful installation, the driver's icon () will appear in your system tray and on your desktop. If the icon is not present, uninstall the driver, reboot, and repeat step 2.

Mac

- (1). Connect the Deco 03 to your computer using the included USB cord.
- (2). Please download the Deco 03 latest driver from the support section of our website, www.xp-pen.com
- (3). Extract the ".zip" file contents before running ".pkg".



Figure 4-1 Mac driver

- (4). If you run into the error message below, please complete the following steps.

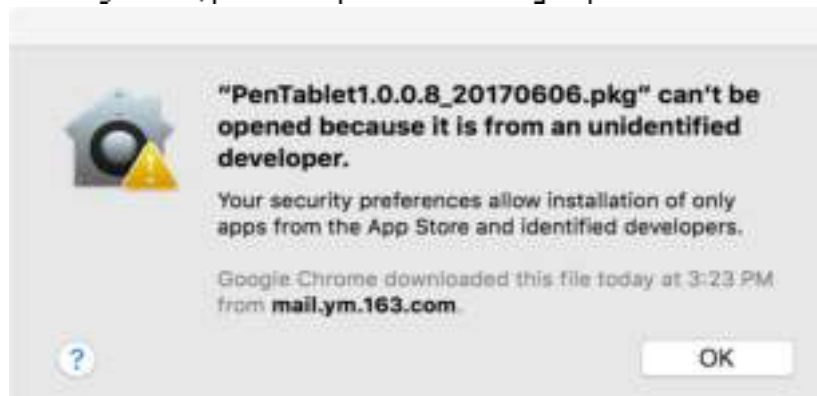

Figure 4-2 Unidentified developer

- a. Open "System Preferences," then "Security & Privacy".



Figure 4-3 Security & Privacy

b. Click "Open Anyway" button.

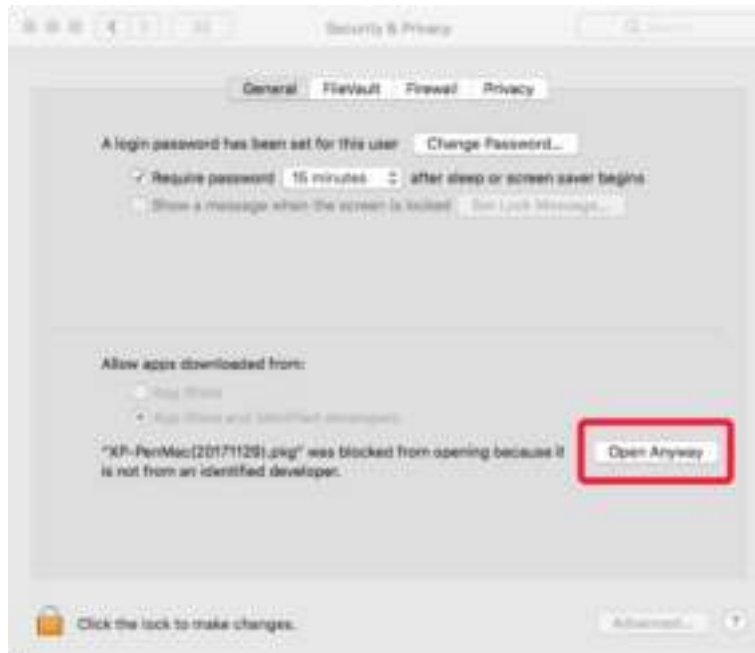

Figure 4-4 Open Anyway

c. Input your username and password, then click "Unlock."



Figure 4-5 Password

{ V. Driver Settings UI }

Notes:

- (a). The Deco 03' express keys are designed to work with US English keyboards. Keys may not function correctly with the other keyboard languages.
- (b). By default, the Deco 03 express keys are mapped to standard Photoshop keyboard shortcuts. Keys can be customized to function efficiently in other software.

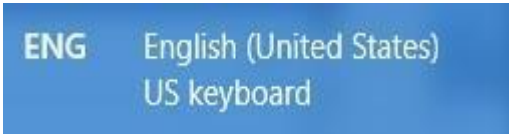



Figure 1. Keyboards

Windows

The Deco 03' driver settings can be opened in two ways:
 Double-click the driver's icon () in system tray or your desktop.

Driver UI

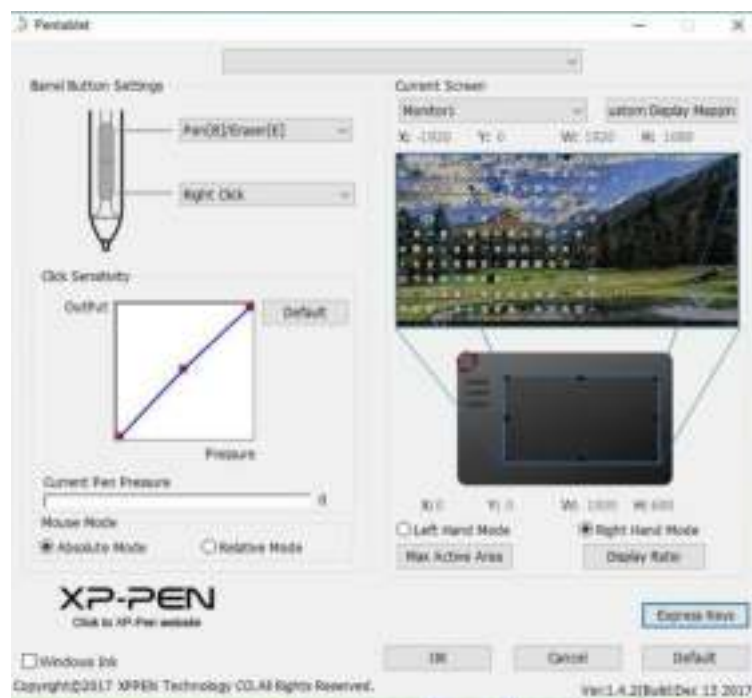

Figure 2. UI

1.1. Pen Function Settings

You may customize the functions of your tablet pen's barrel buttons here. Use the "Function Key" option to program custom keystrokes.

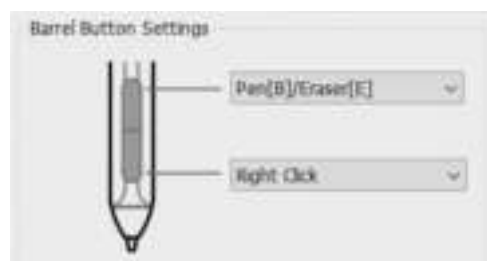

Figure 3. Pen Functions Setting

Note:

Pen/Eraser Toggle

With the stylus in range of the Deco 03' working area, press the assigned barrel button to toggle between pen and eraser modes in compatible drawing software. The current mode will briefly be displayed on your monitor.

1.2. Click Sensitivity & Current Pen Pressure

You can adjust pen pressure to "Output" or "Press" sensitivity on here.

Current Pen Pressure shows the current pressure level being exerted on your tablet and can be used to test pen pressure.

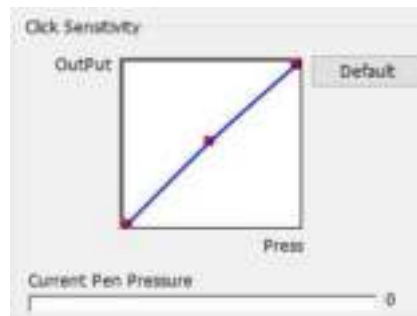

Figure 4: Click Sensitivity & Current Pen Pressure

1.3. Current Screen

The Deco 03 may be configured for use with single or dual monitors. If only one monitor is selected, your tablet input will be limited to that particular monitor. And the dimensions of your tablet's on-screen work area can be changed here.

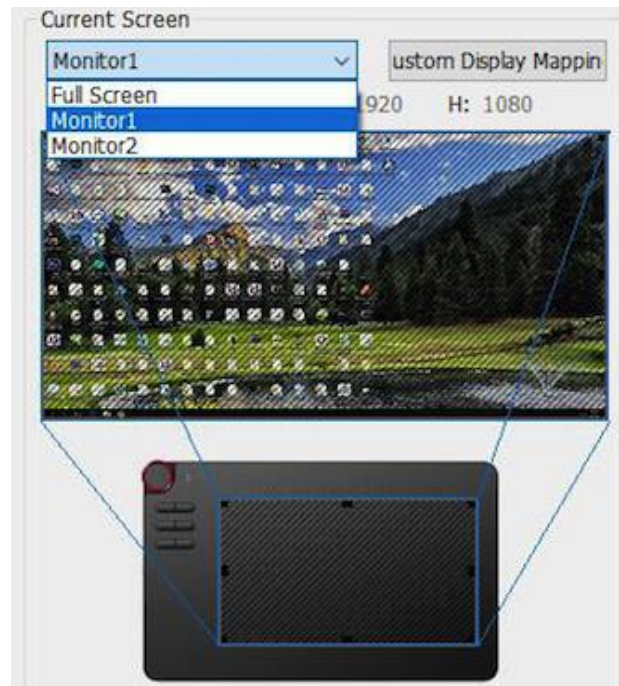

Figure 5: Update Screen & Full Screen

1.4. Mouse Mode

Absolute (iPen) Mode: Standard tablet mode: Each point of the tablet's work area corresponds to an absolute point on your computer display.
Relative (iMouse) Mode: Mouse mode: The tablet's work area does not correspond to absolute points on your computer display and your pen works as a standard mouse.



Figure 6: Mouse Mode

1.5. Windows Ink

Windows Ink capability can be toggled on and off here. Enabling this will allow support for Windows Ink and applications that run using Windows Ink.



Figure 7: Windows Ink

1.6. Right/Left Hand Mode & Max Active Area/Display Ratio

The Deco 03 are set up for right-handed use by default. When switching to left-handed mode, be sure to rotate the actual physical tablet 180 degrees to place its shortcut keys on its opposite side.

Max Active Area & Display Ratio

You can set your Deco 03 work area to the max or adjust the tablet's on-screen working area to match your monitor's resolution.

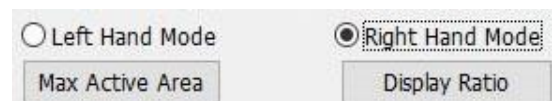

Figure 8: Right/Left Hand Mode & Max Active Area/Display Ratio

1.7. Express Keys Setting

In this tab, you may edit the functions of the Deco 03' shortcut keys. Use the 'Definition' option to program custom keystrokes.

Disable express keys: When you enable it, all of the express keys function will be disabled.

When you enable it, and click any express keys the message will not popup on the bottom of screen.

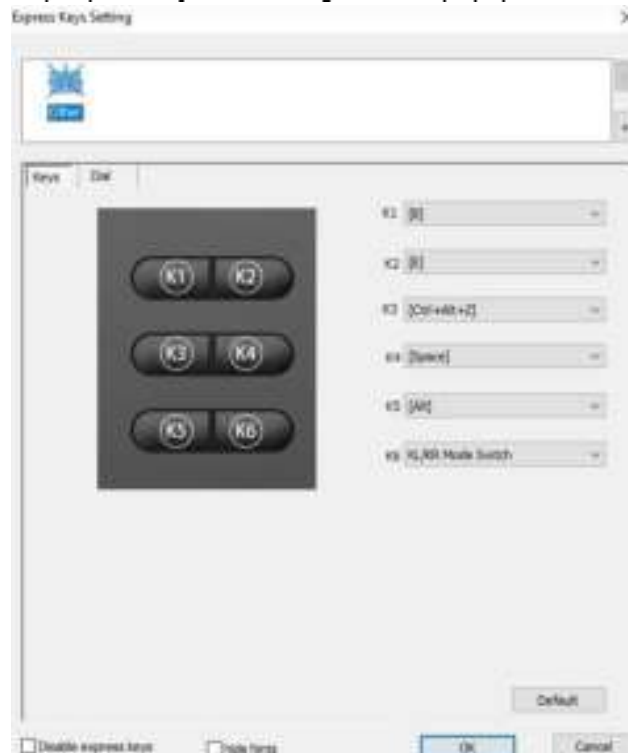

Figure 13: Keys

'KL' defines the function performed when spinning the roller key to the left. 'KR' defines the function for spinning to the right.

You also can define 4 suites dial functions on it.

Click "Default" to revert to manufacturer settings.

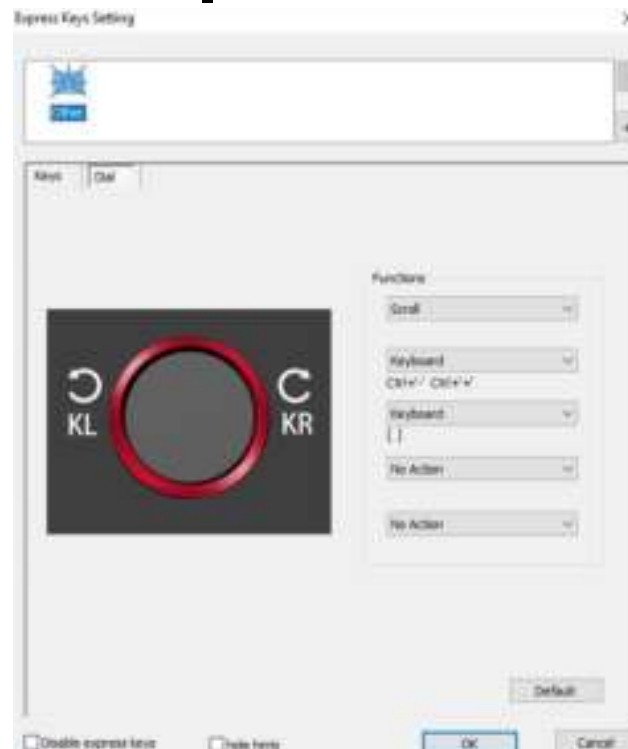

Figure 13: Dial

Mac

To open the Deco 03' driver settings, open Finder > Applications > PenTabletSetting.



Figure 11: Uninstall Setting

1.1. Pen



Figure 12: Pen UI

In this tab, you may customize the functions of your stylus's barrel buttons, adjust pressure sensitivity, and test your pen pressure.

Click "Default Button Setting" to revert to manufacturer settings.

The Deco 03 can also be configured for right or left-handed use in this tab. When switching to left-handed mode, be sure to rotate the actual physical tablet 180 degrees to place its shortcut keys on its opposite side.

Absolute (Pen) Mode: Standard tablet mode; Each point of the tablet's work area corresponds to an absolute point on your computer display.

Relative (iMouse) Mode: iMouse mode; The tablet's work area does not correspond to absolute points on your computer display and works as a standard mouse.

Note:

Pen/Eraser Toggle

With the stylus in range of the Deco 03's working area, press the assigned barrel button to toggle between pen and eraser modes in compatible drawing software. The current mode will briefly be displayed on your monitor.

1.2. Monitor

The "Monitor" tab allows you to configure your tablet for use with single or dual monitors. The tablet can also be configured to use only a portion of your display.



Figure 13: Full Monitor



Figure 14: Single Monitor



Figure 15: Single Monitor (Portion)

1.3. Tablet Area

You may adjust your tablet's on-screen working area in this tab.

'Full Area' automatically selects the largest possible working area.

'Screen Ratio' adjusts the tablet's on-screen working area to match your monitor's resolution.

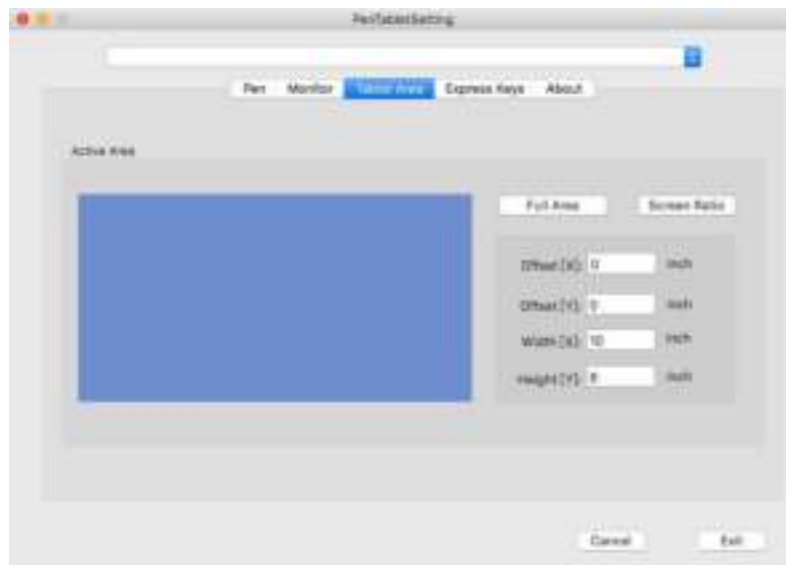

Figure 16: Full Area

1.4. Express Keys

In the Express Keys tab, you may choose your preferred functions for the Deco 03 shortcut keys. Use the "Reset Customer Defined" option to program custom keystrokes.



Figure 17: Express Keys

Click "Built-in Function Key:" to add or remove functions from the K1 key's queue.



Figure 18: Slider Switch Setting

1.5. About

This tab displays the current version of your driver software.



Figure 19: About

{ VI. Driver Uninstallment }

Windows

In the Start menu, open [Settings] → [Apps & features].
Find "Pen Tablet" and click "Uninstall." Follow the on-screen instructions.

Mac

Open [Finder] → [Application] → [Pen Tablet], then click "Uninstall Pen Tablet" and follow the on-screen instructions.

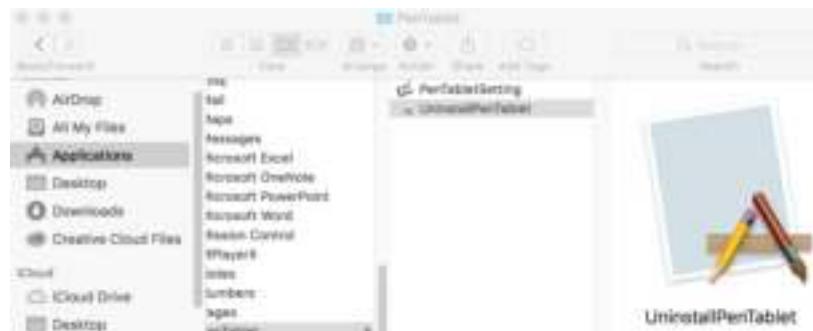

Figure 1 Mac Uninstallment

NOTE:

When attempting to reinstall the Deco 03 driver, be sure to reboot your computer after the unInstall is complete.

{ VII. FAQ }

1. I can't use the stylus to control the cursor.

a. Does the tablet's status indicator light come on when the stylus is in contact with the working area?

Yes: Uninstall the Deco 03 driver. If its uninstaller will not run, run the driver's installer again, then uninstall. Reboot, then connect the tablet to your computer and test your stylus. If the cursor responds to your pen input, the tablet's hardware is functional. Reinstall the Deco 03 driver according to these steps (Windows):

Download the tablet's latest driver from www.xp-pen.com, then extract the ".zip" contents to the desktop.

Close all non-essential software and processes (Some software may use the wintab process and interfere with the driver installation. OneDrive in particular often causes issues: its system tray icon looks like two grey clouds).

Open C:\Windows. Using the "search" box near the top-right of the window, search for "WinTab32.dll" and delete any instances. Connect the tablet and power it on, then run the driver installation. Complete the installation, then reboot. If the tablet's system tray icon is not visible after rebooting:

Open C:\Windows. Open File >>> Folder and Search options>>> View. Enable "Show hidden files and folders," then exit options. Search for "wclient2." Right-click both instances and "Run" each as Administrator. The driver icon should appear.

No: Ensure that the tablet's power switch is turned ON. If you are using wireless USB mode, test the tablet with a wired USB connection.

2. The Deco 03' response time is slow during wireless USB use.

a. The tablet's battery may be running low. Test the tablet in wired USB mode.

3. How do I know that the Deco 03 driver installed successfully?

a. After installing the driver, the Deco 03' driver icon  should be visible in your system tray on the bottom-right of your screen (Windows OS). Pen input will control the cursor and pressure sensitivity will be functional in the driver UI's "Pressure Test" tab.

4. How do I determine if a problem is software or hardware related?

a. Connect and install the Deco 03 on a different computer. If the tablet functions properly on the new computer, you are experiencing a software issue—confirm that ALL tablet drivers (including the Deco 03) are uninstalled and removed from your computer, then reinstall the Deco 03.

b. The Deco 03' indicator lights will help you determine if an issue is hardware-related. When functioning properly, the white status indicator light will light up when the stylus pen is in range of or touching the tablet's working area. If the light does not turn on under these conditions while the Deco 03 is powered ON, you may be experiencing a hardware issue.

If you have any questions, please contact us at:

Skype: XP-Pen

Web: www.xp-pen.com

Email: service@xp-pen.com