

Sicherheitsbestimmungen · Safety instructions · Consignes de sécurité  
 Disposiciones de seguridad · Norme di sicurezza · Veiligheidsbepalingen ·  
 Prescrições de segurança · Säkerhetsbestämmelser · Turvallisuusohjeet  
 Zasady bezpieczeństwa · Biztonsági rendelkezések · Varnostna določila  
 Bezpečnostní předpisy · Bezpečnostné predpisy · Sikkerhetsbestem-  
 melser · Sikkerhedsbestemmelser · أنظمة السلامة · Διατάξεις ασφαλείας ·  
 安全准则 · 안전수칙

#370160139 Drift Car

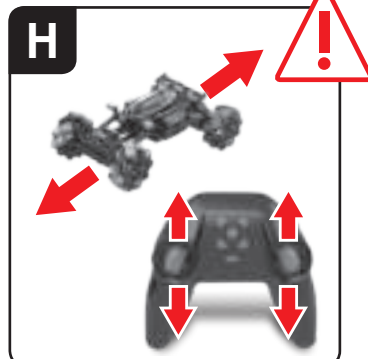
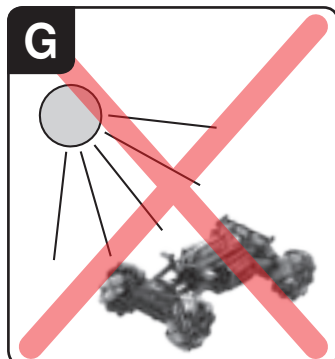
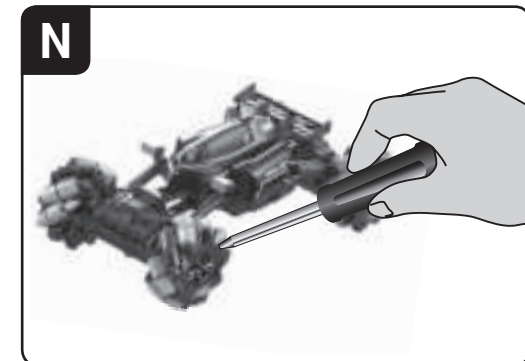
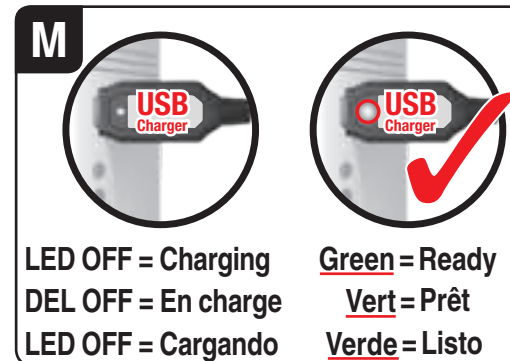
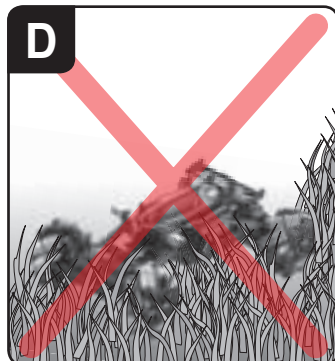
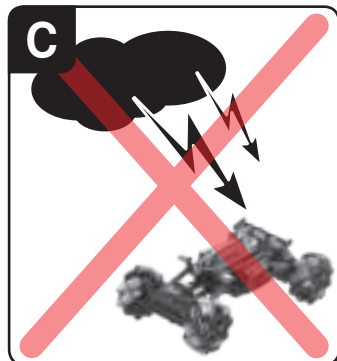
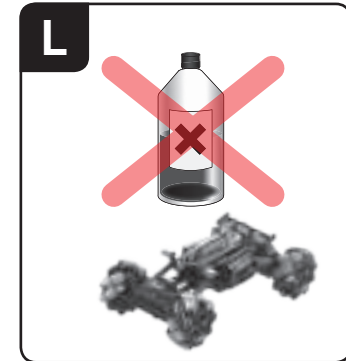
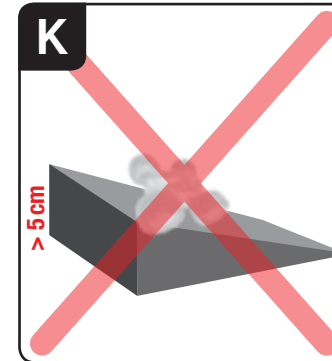
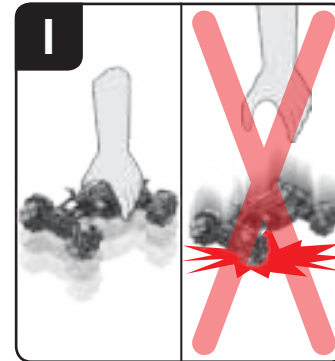

Vorläufiges Modell/Symbolabbildung  
 Preliminary model/Symbolic image only  
 Modèle provisoire/Illustration avec symboles  
 Modelo provisional/Illustración de símbolo

**1**

**USB Charger**

**6,4 V 700 mAh!  
4,48 Wh LiFePO<sub>4</sub>**

**2x 1.5 V Micro AAA batteries  
2x Piles 1, 5 V micro AAA  
2x Pilas de 1,5 V Micro AAA**

**8**

**~ 20 km/h**

**4m** **5m**

**9**

**2**

**1** **2** **6,4 V 700 mAh!  
4,48 Wh LiFePO<sub>4</sub>**

**LED OFF = Charging  
DEL OFF = En charge  
LED OFF = Cargando**

**Green = Connection OK  
Vert = Connexion OK  
Verde = Conexión OK**

**Green = Ready  
Vert = Prêt  
Verde = Listo**

**10**

**R** **L**

**11**

**360°**

**3**

**6,4 V  
700 mAh!  
4,48 Wh  
LiFePO<sub>4</sub>**

**4**

**2x 1.5 V Micro AAA batteries  
2x Piles 1, 5 V micro AAA  
2x Pilas de 1,5 V Micro AAA**

**12**

**L 2** **1 R** **2** **L** **R** **1**

**13**

**3** **4** **5** **6**

**5**

**OFF** **ON**

**6**

**OFF** **ON**

**7**

**14**

**ON-Road**

**OFF-Road**

**7**

**15**