



# CITY



60167



 [LEGO.com/city](http://LEGO.com/city)

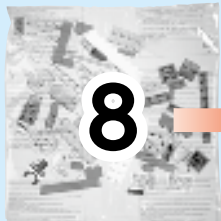
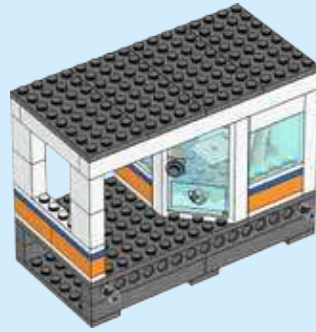

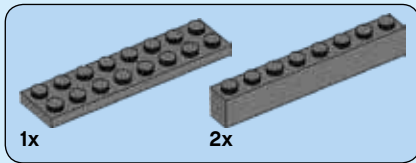
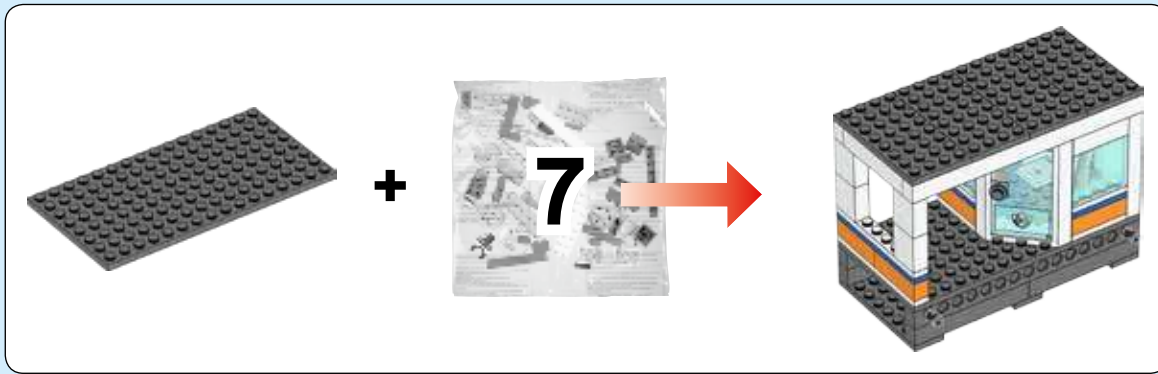

1

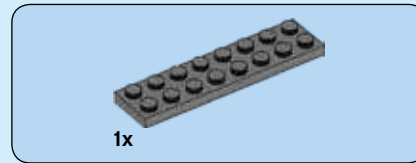
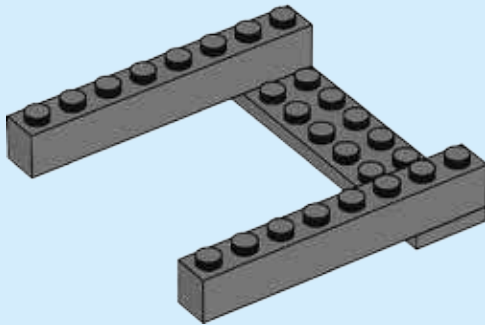

2

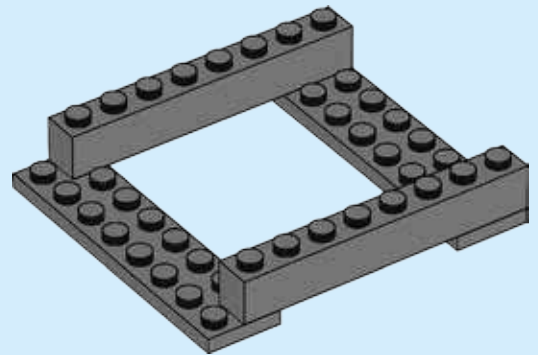

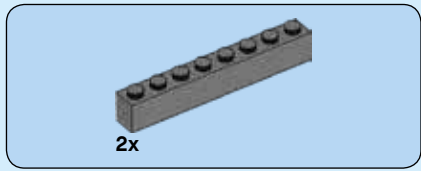

3

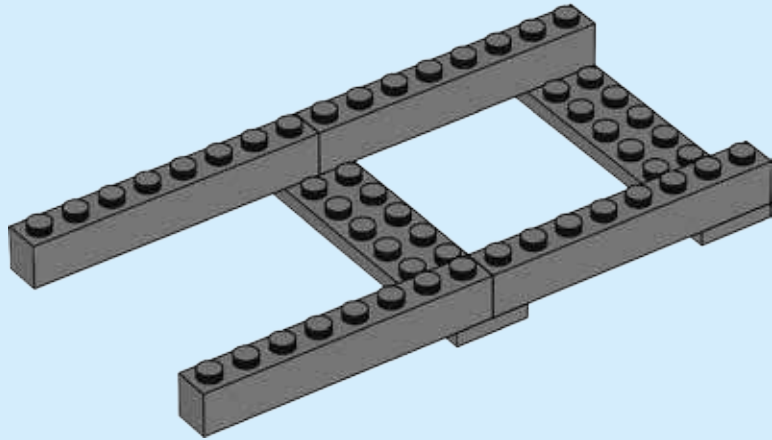

4

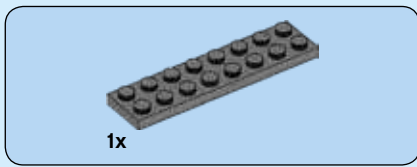

4

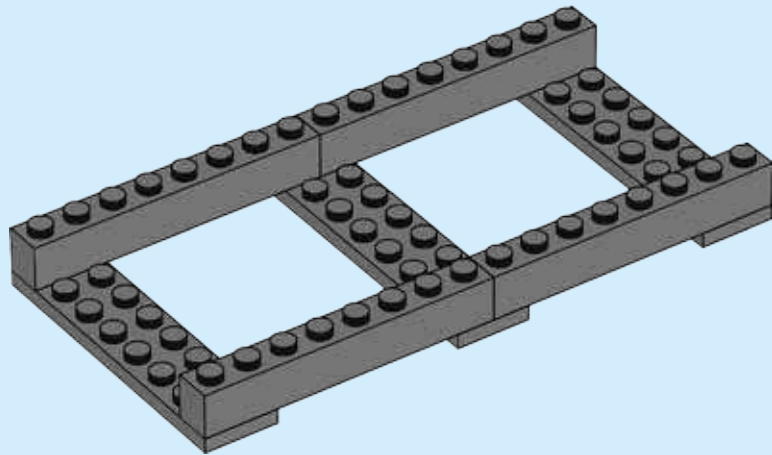

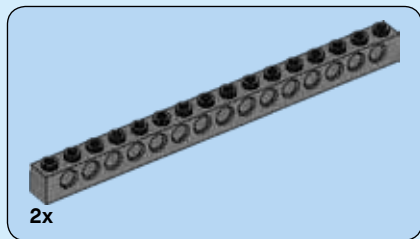

5

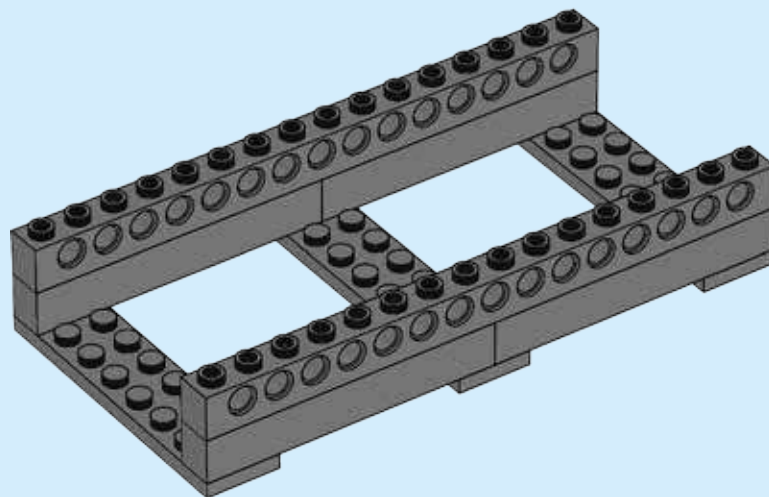

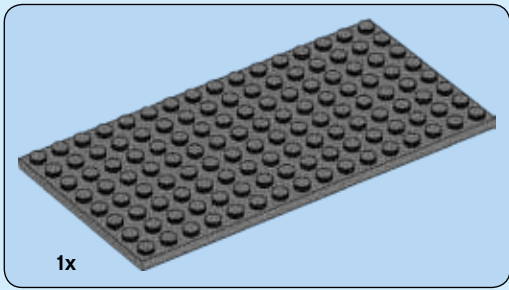

6

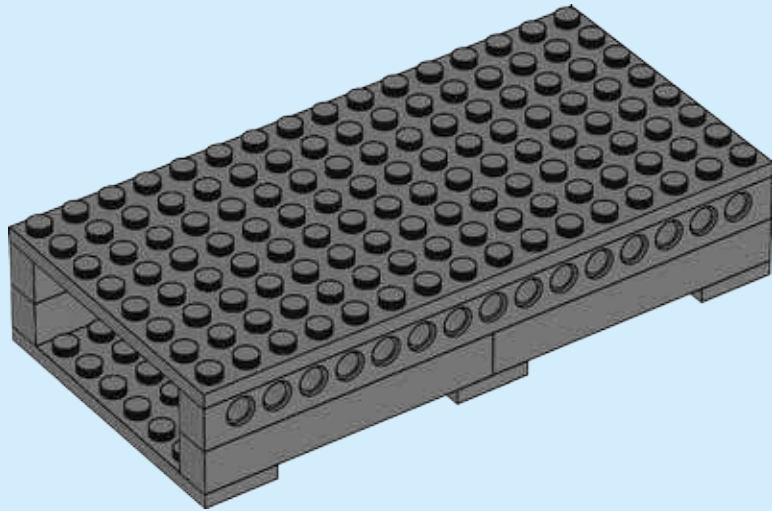





2x

7

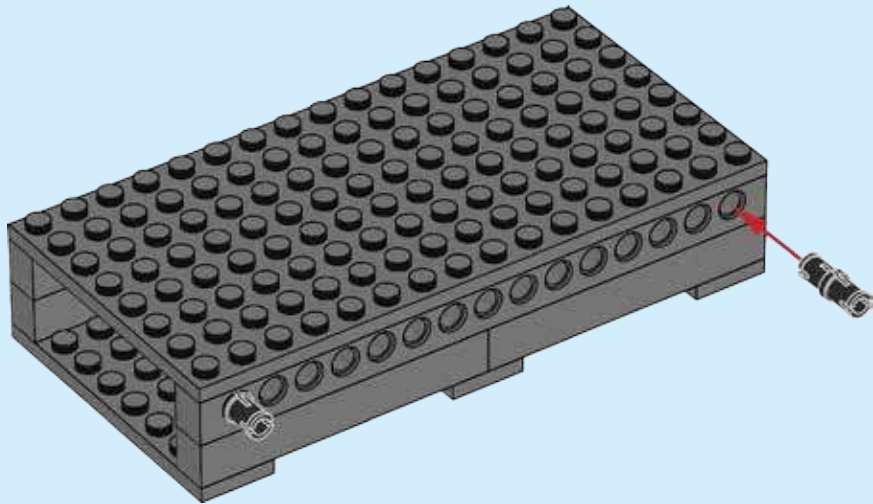

8



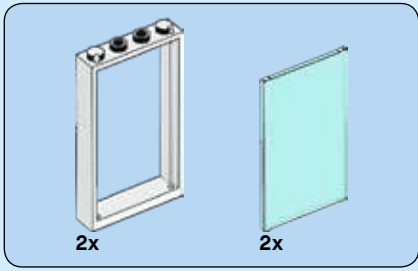

8

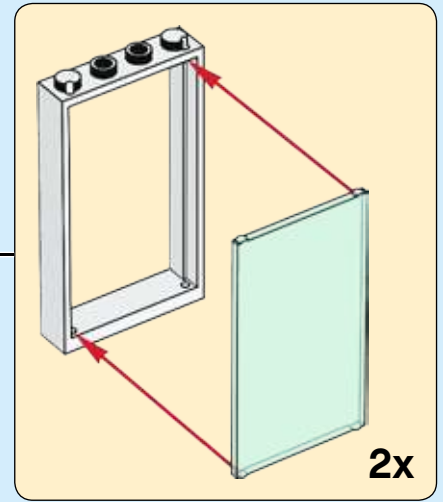
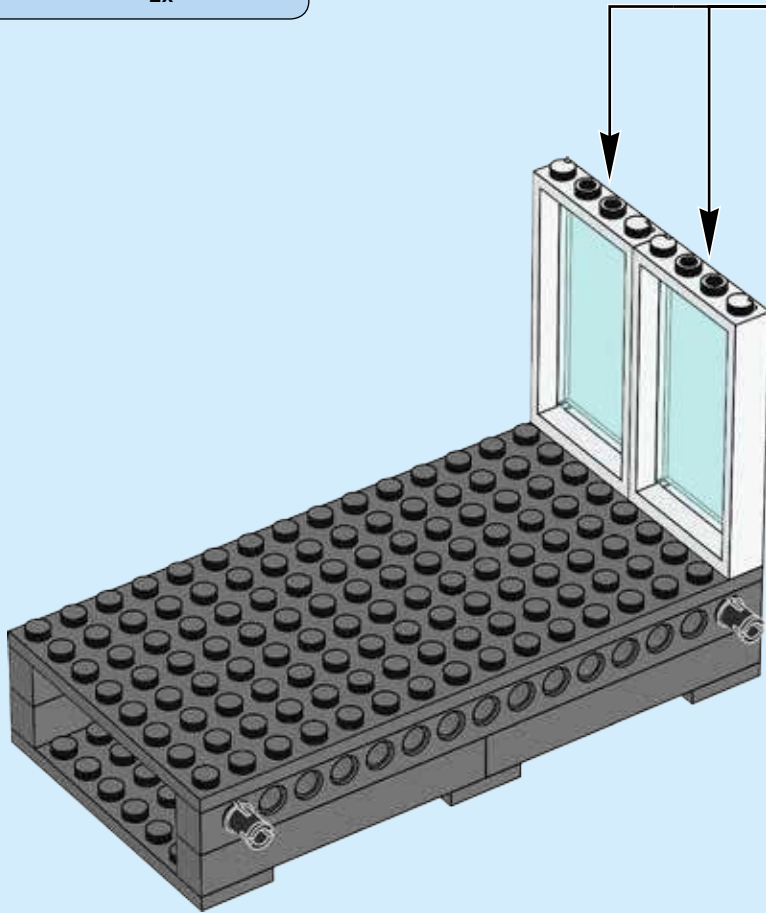

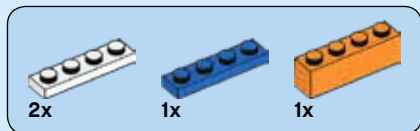

9

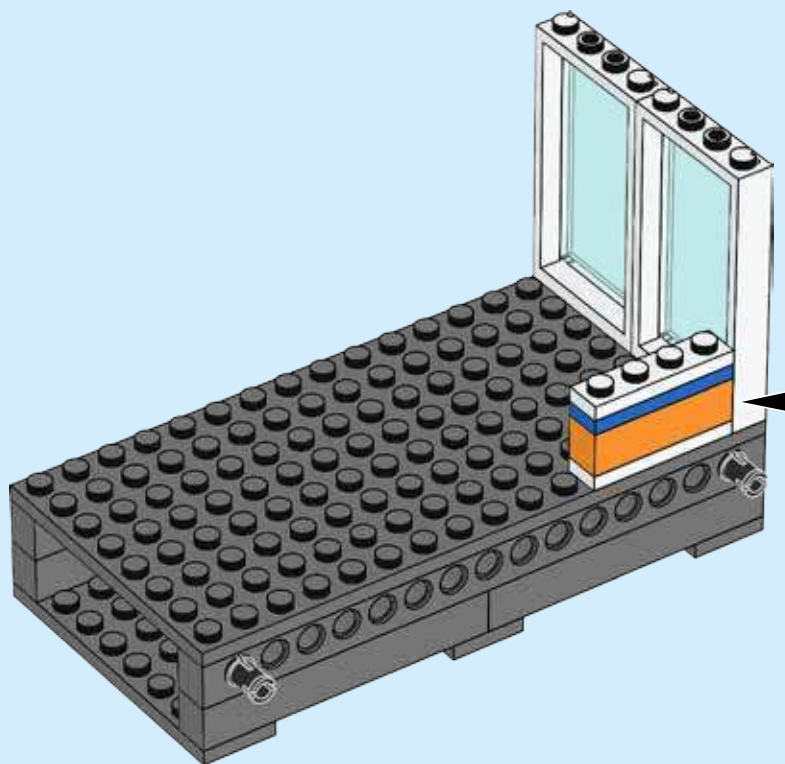
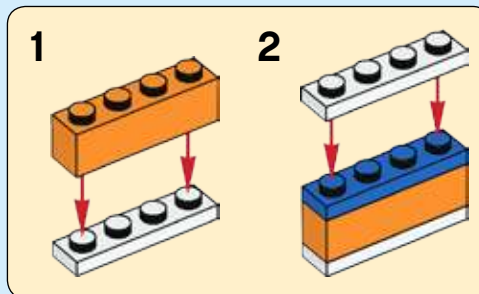

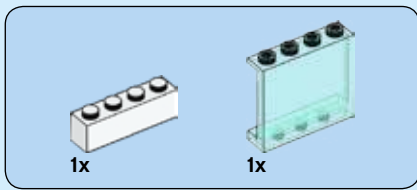

10

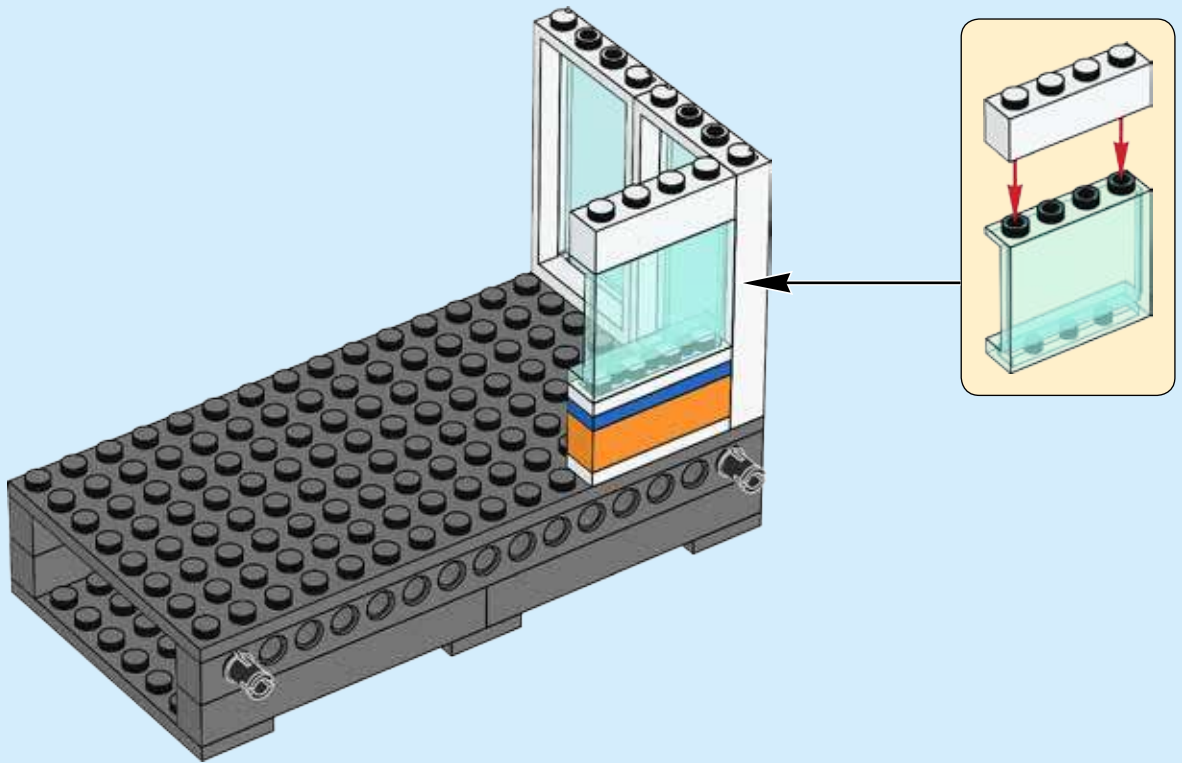

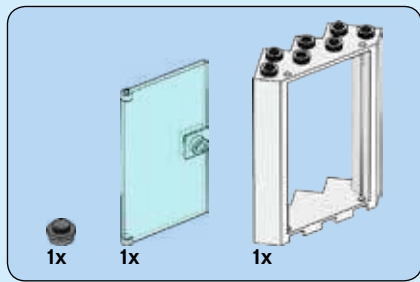

11

1

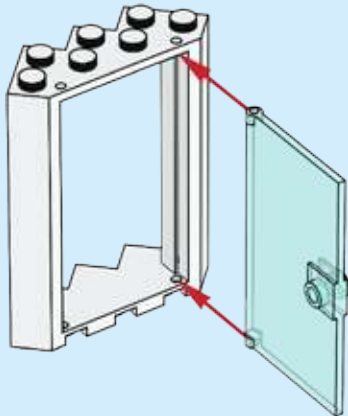

2

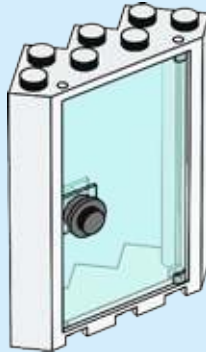

3



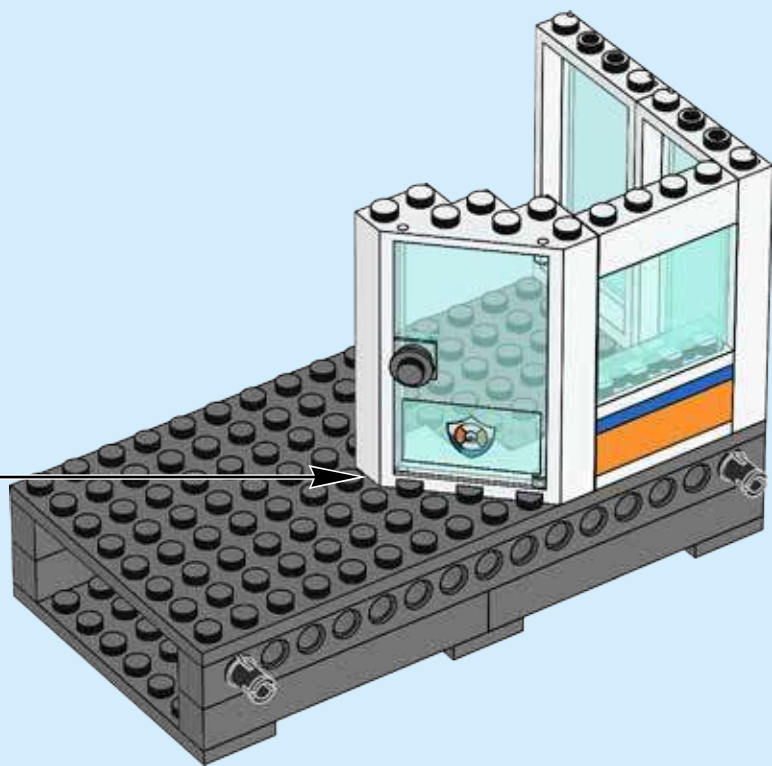



1x



1x

# 12

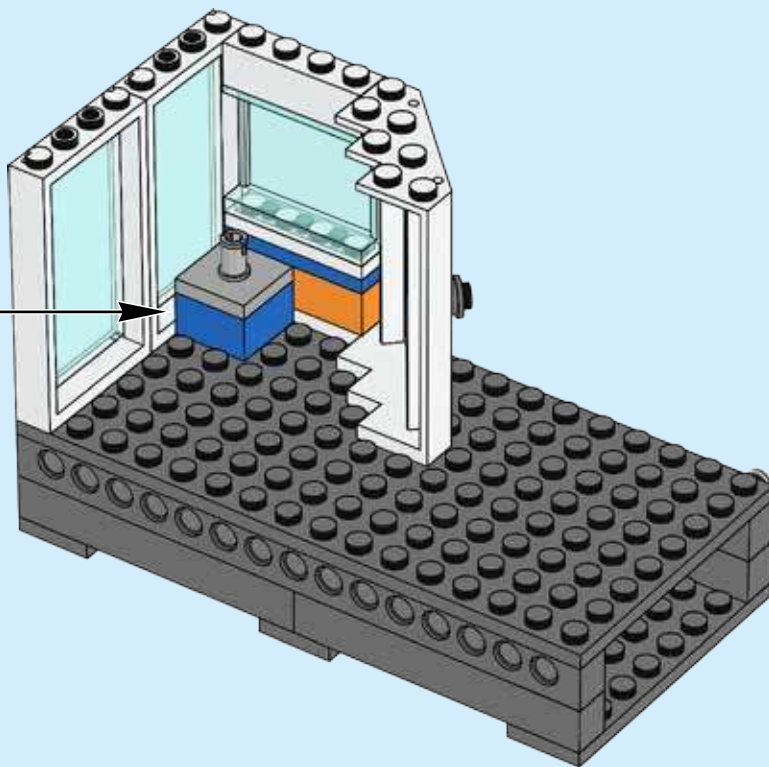
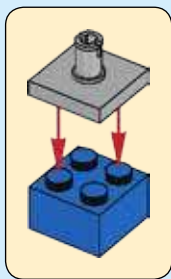
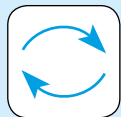

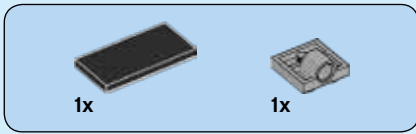

# 13

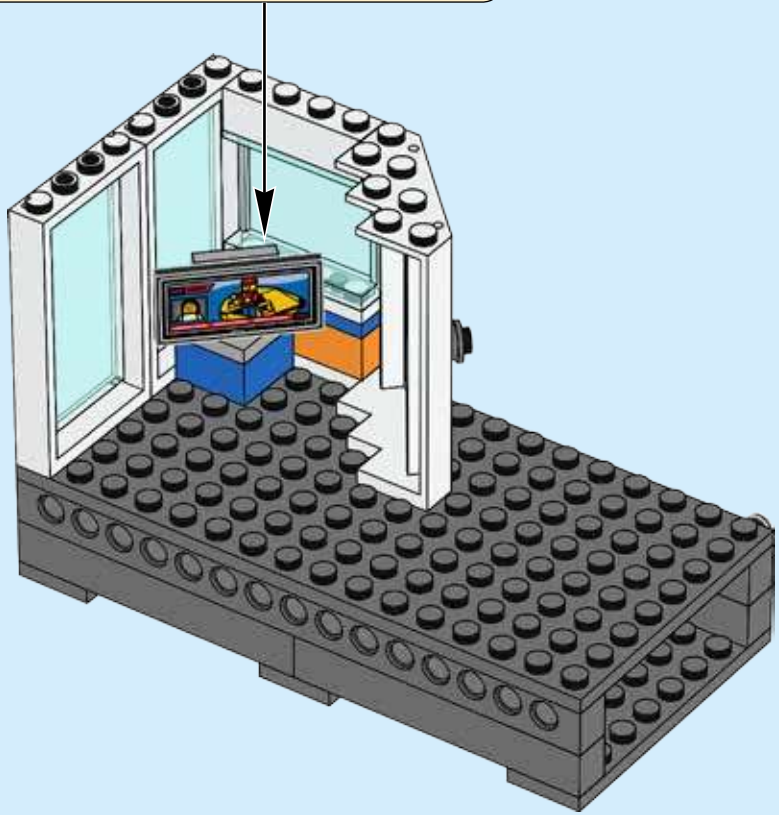
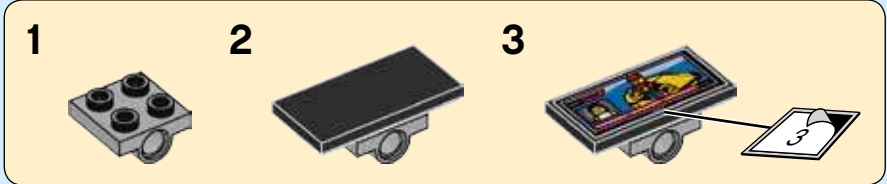



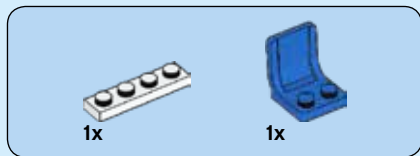

14

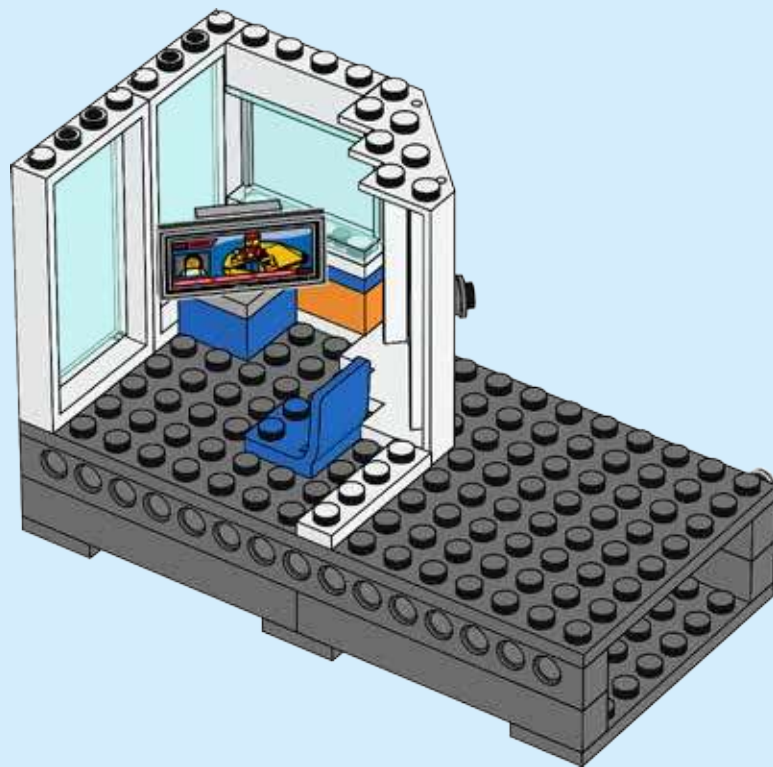



15

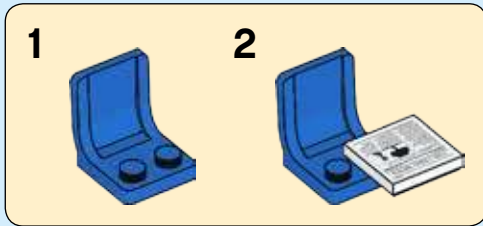
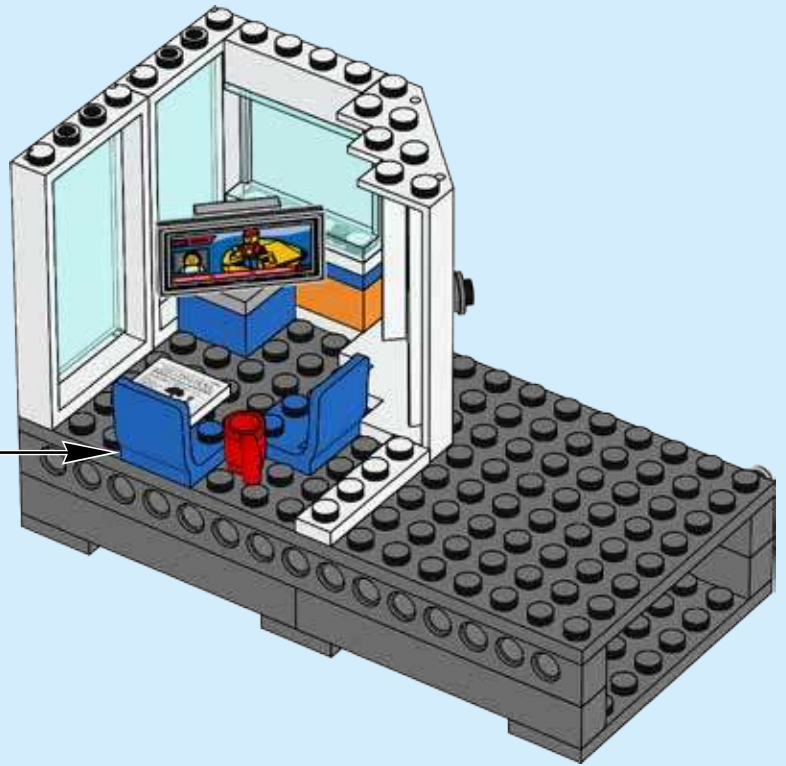

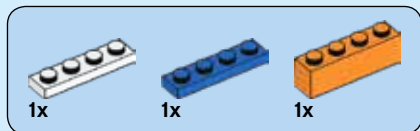

16

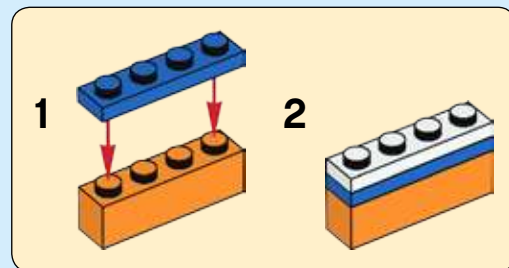
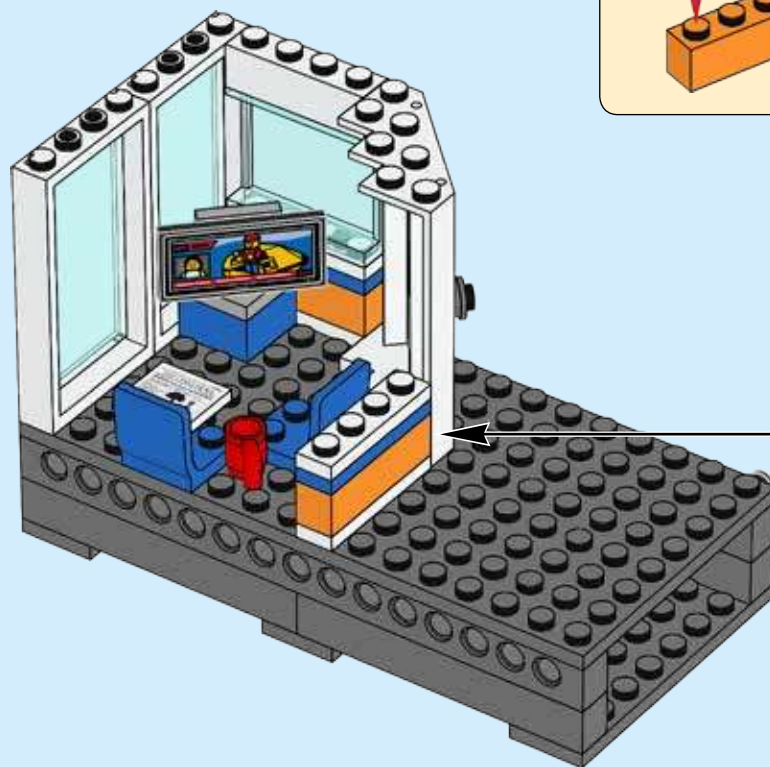

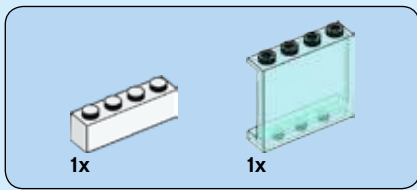

17

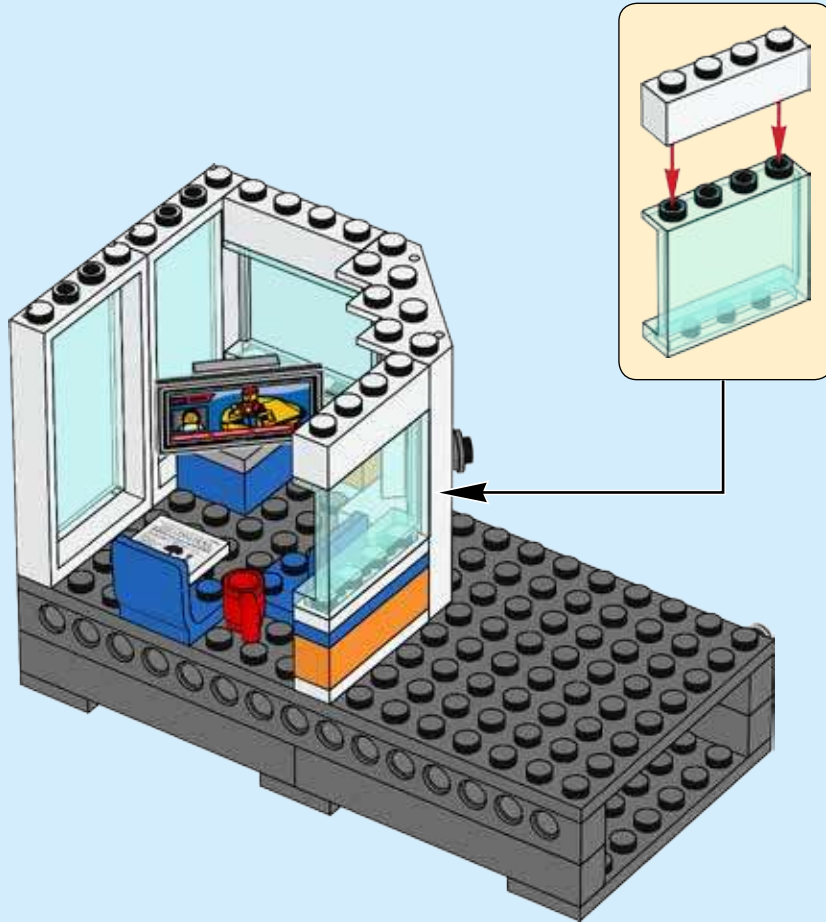

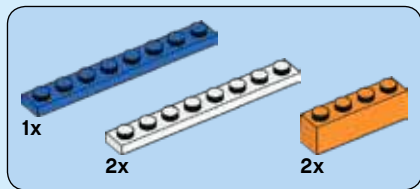

18

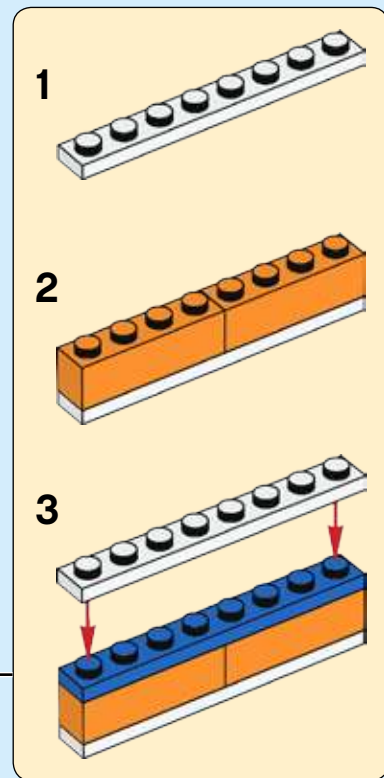
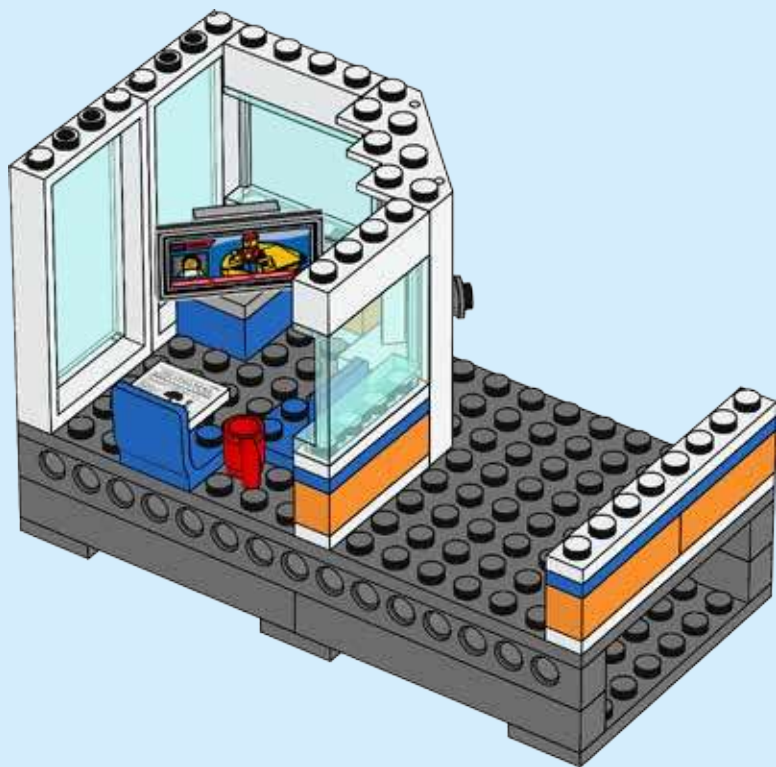



4x

19

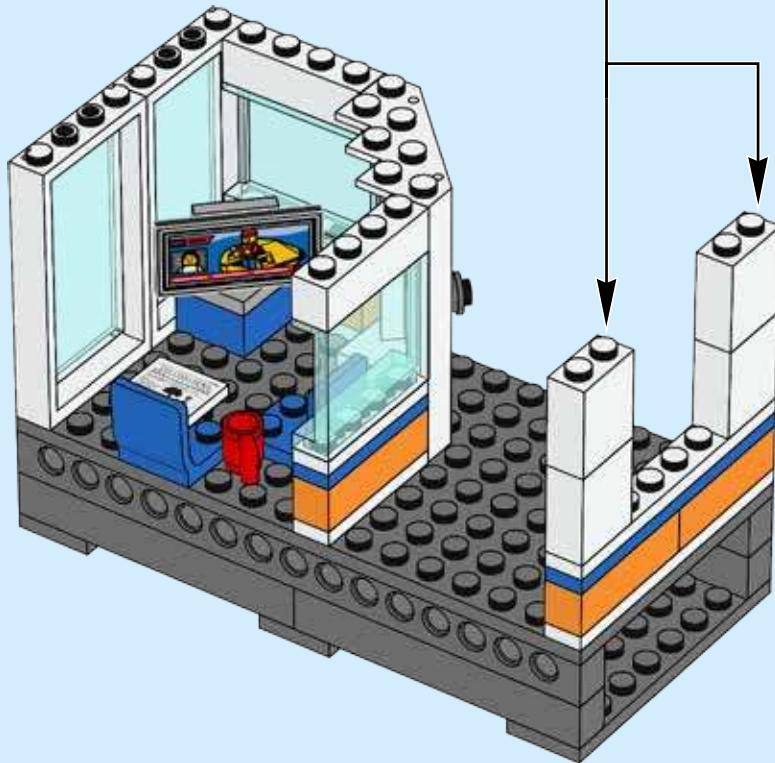
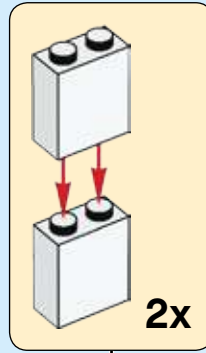



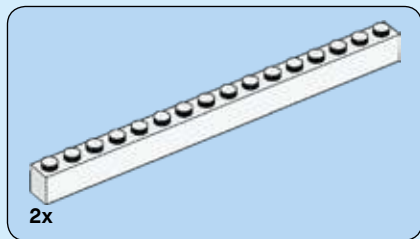

20

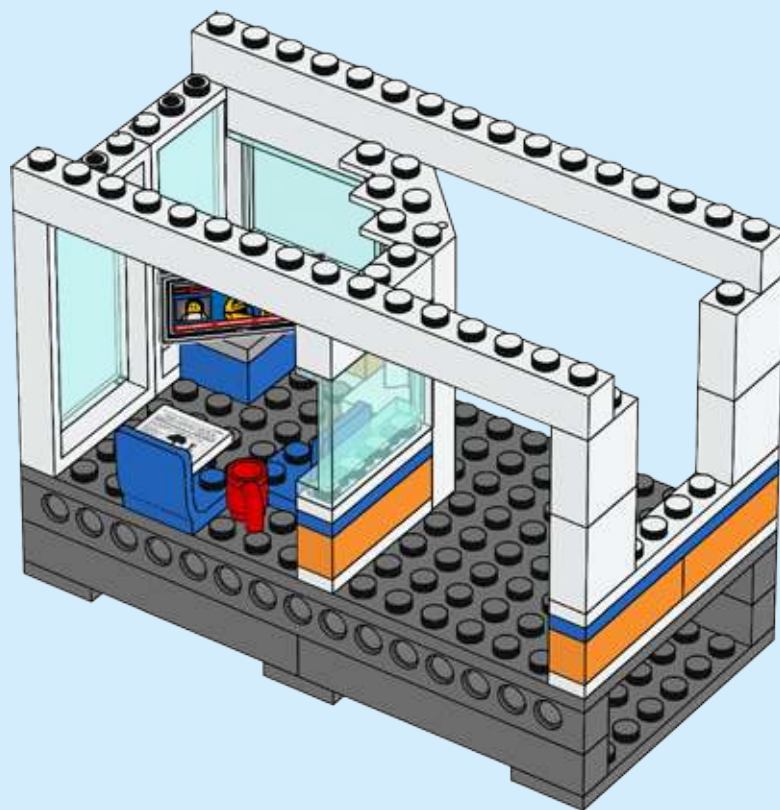



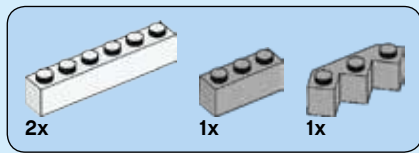

21

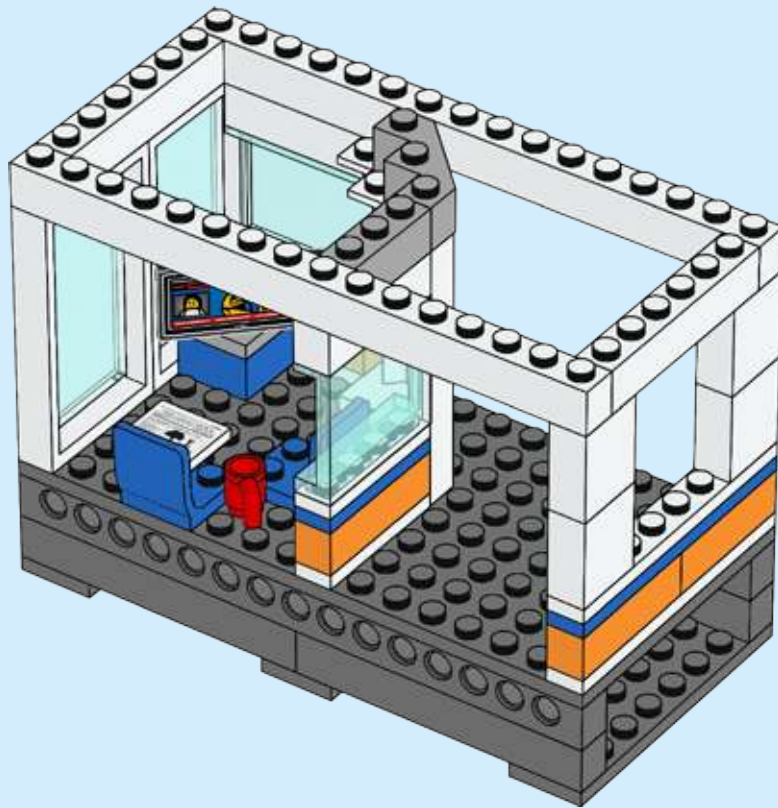

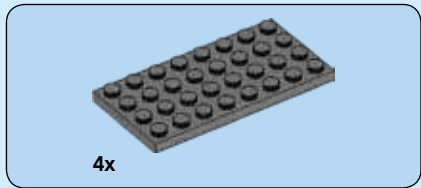

22

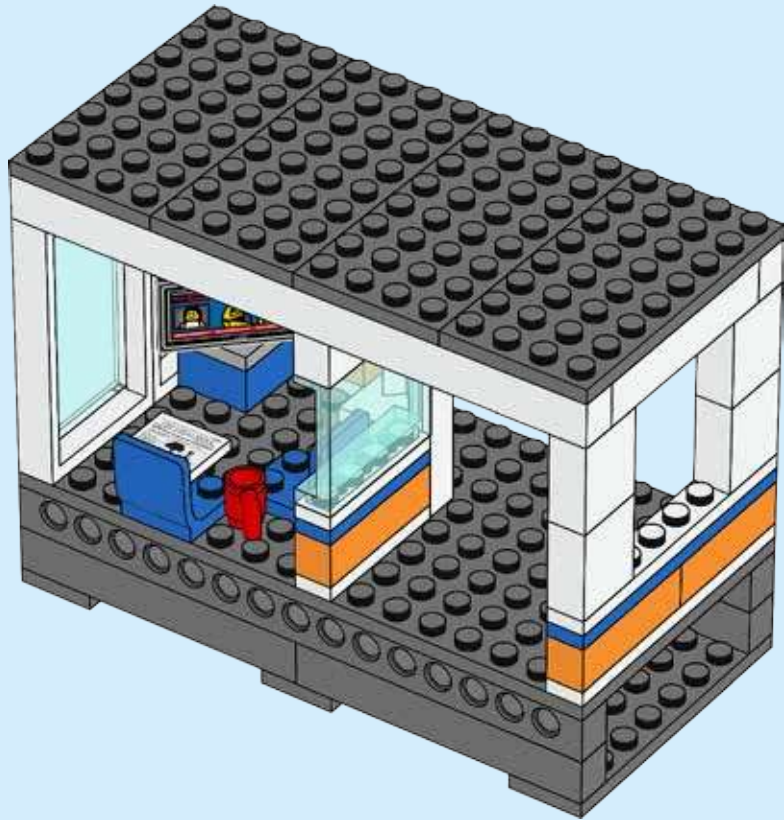



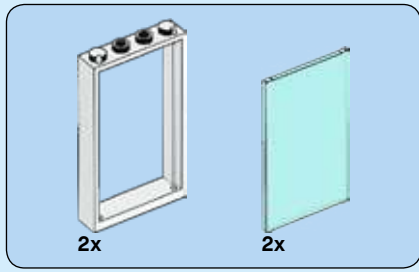

23

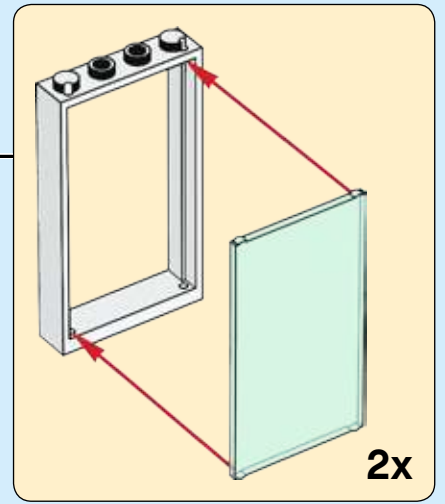
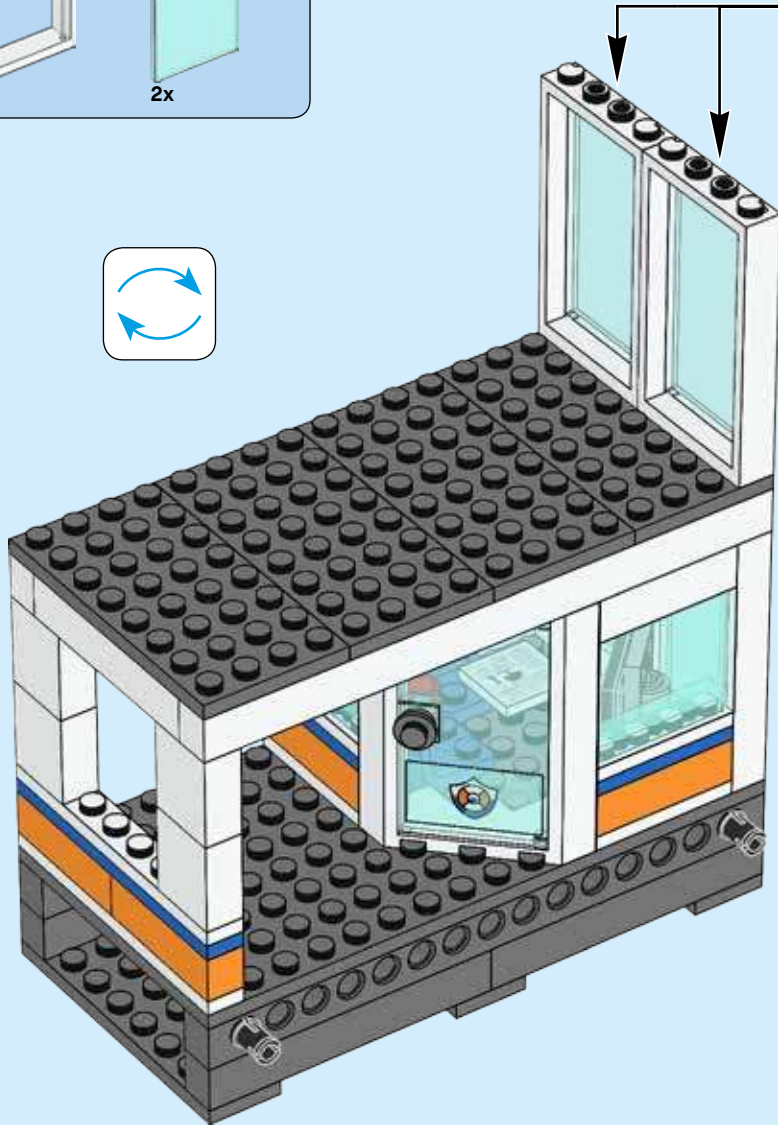
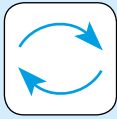

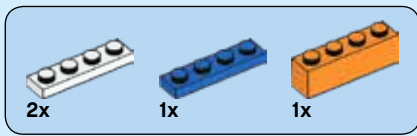

24

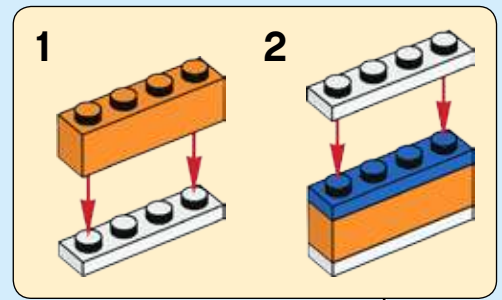
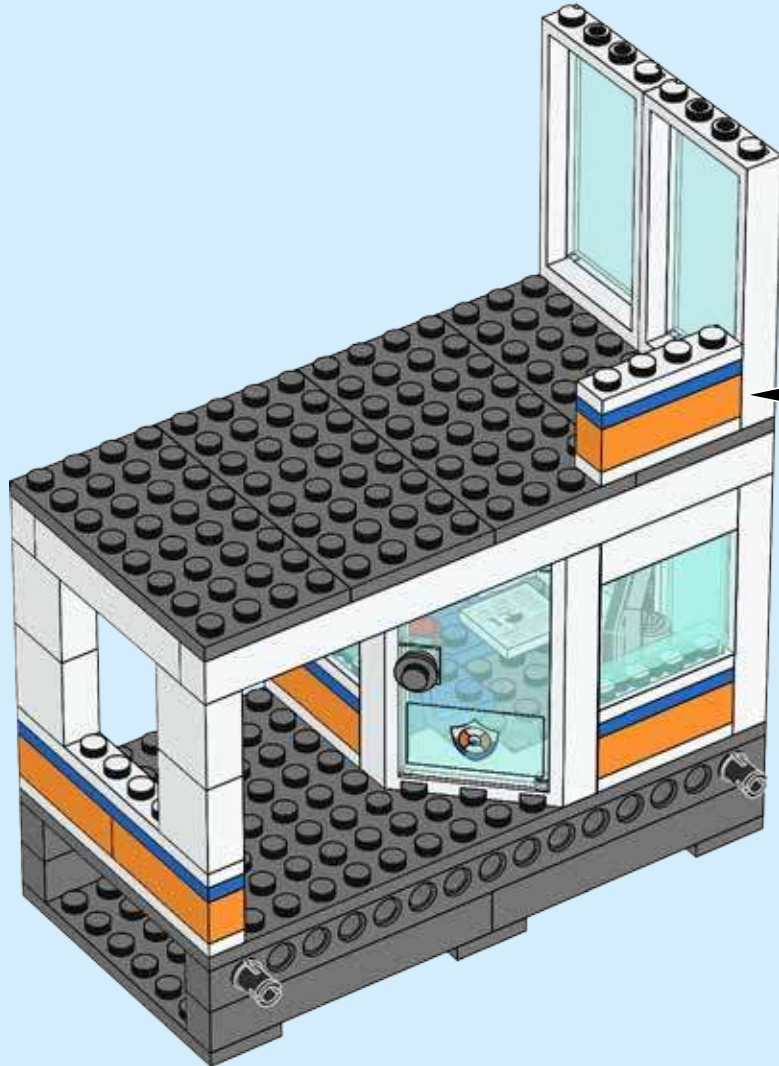

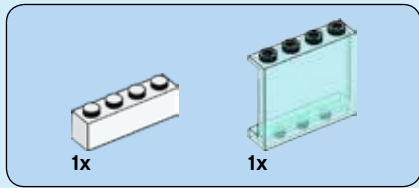

25

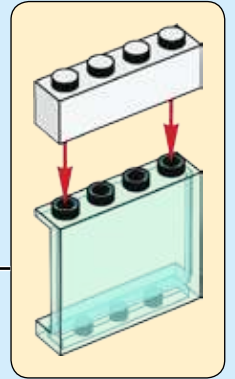
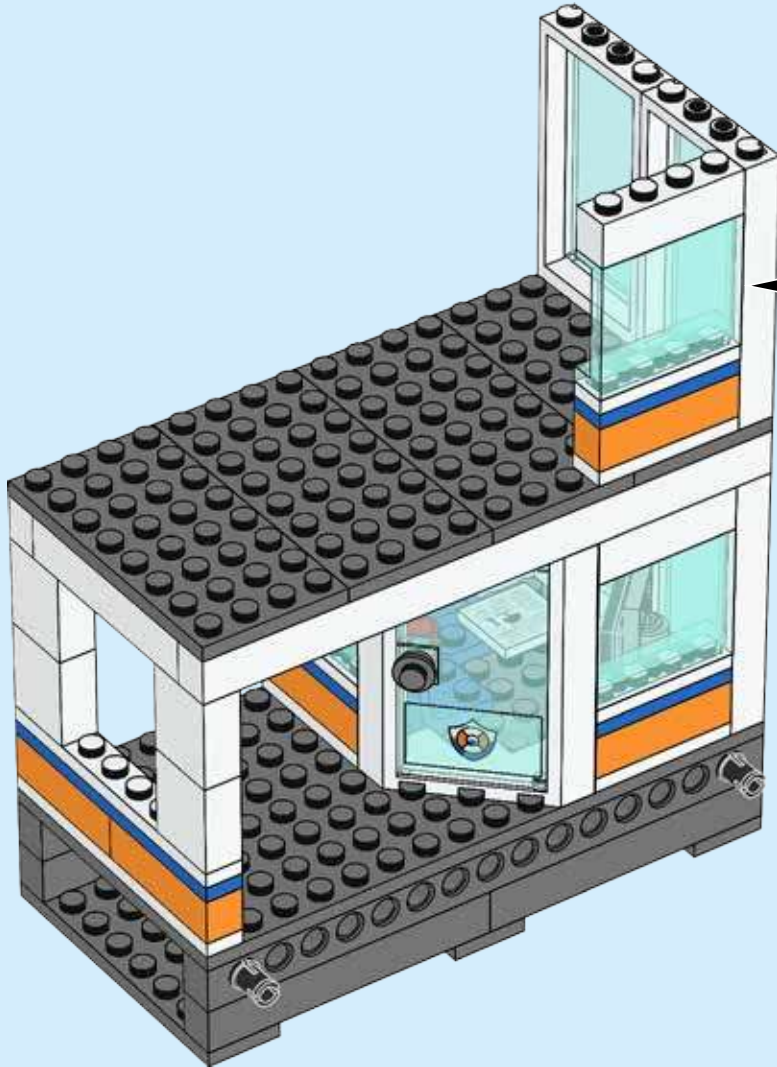



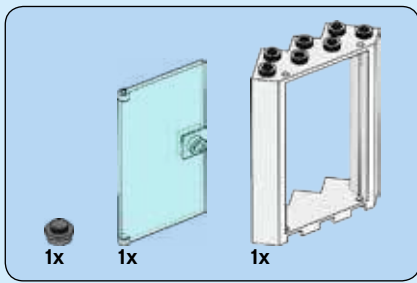

26

1

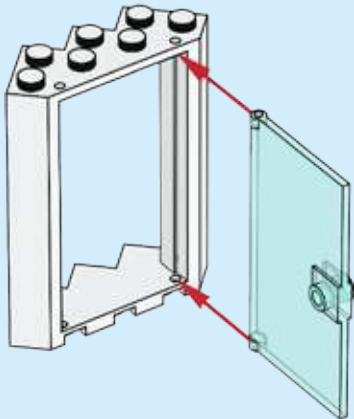

2

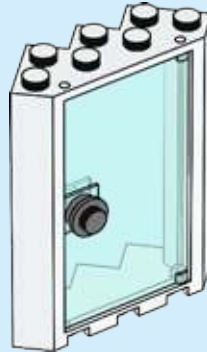

3





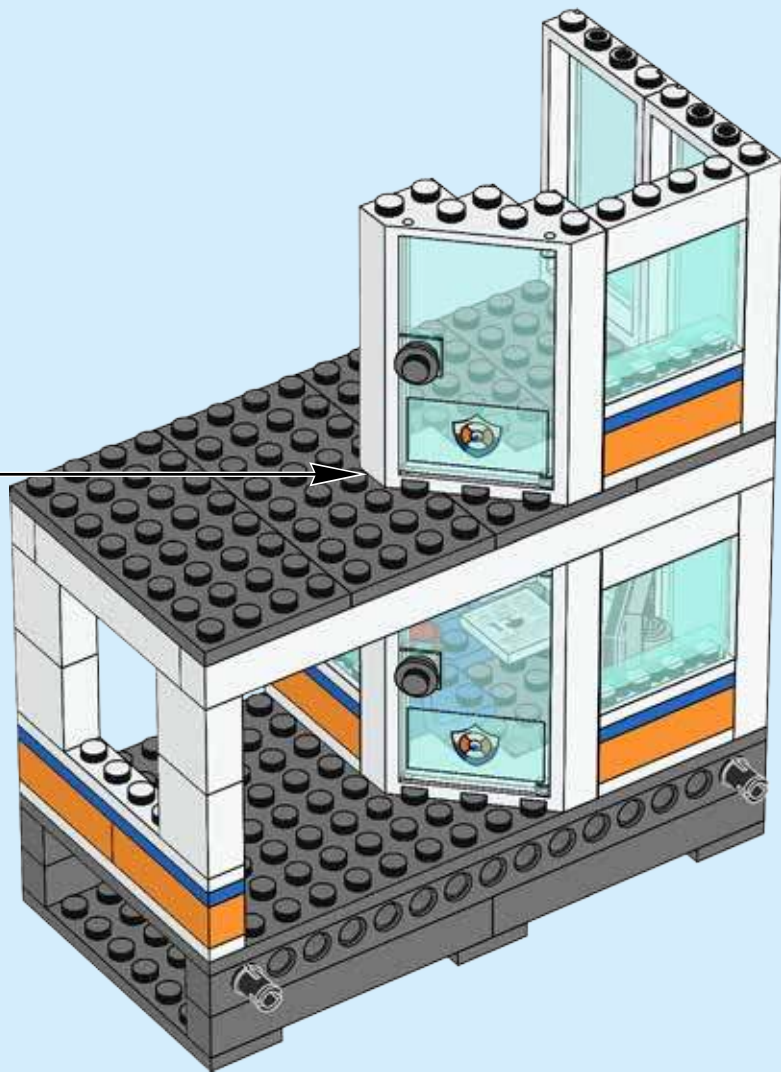

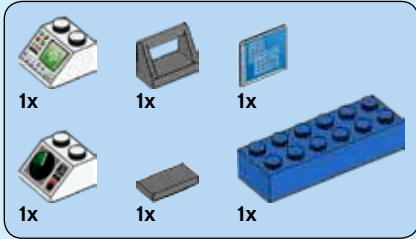

**27**

**1**

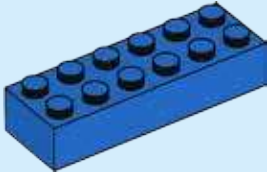

**2**

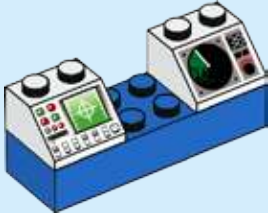

3



4



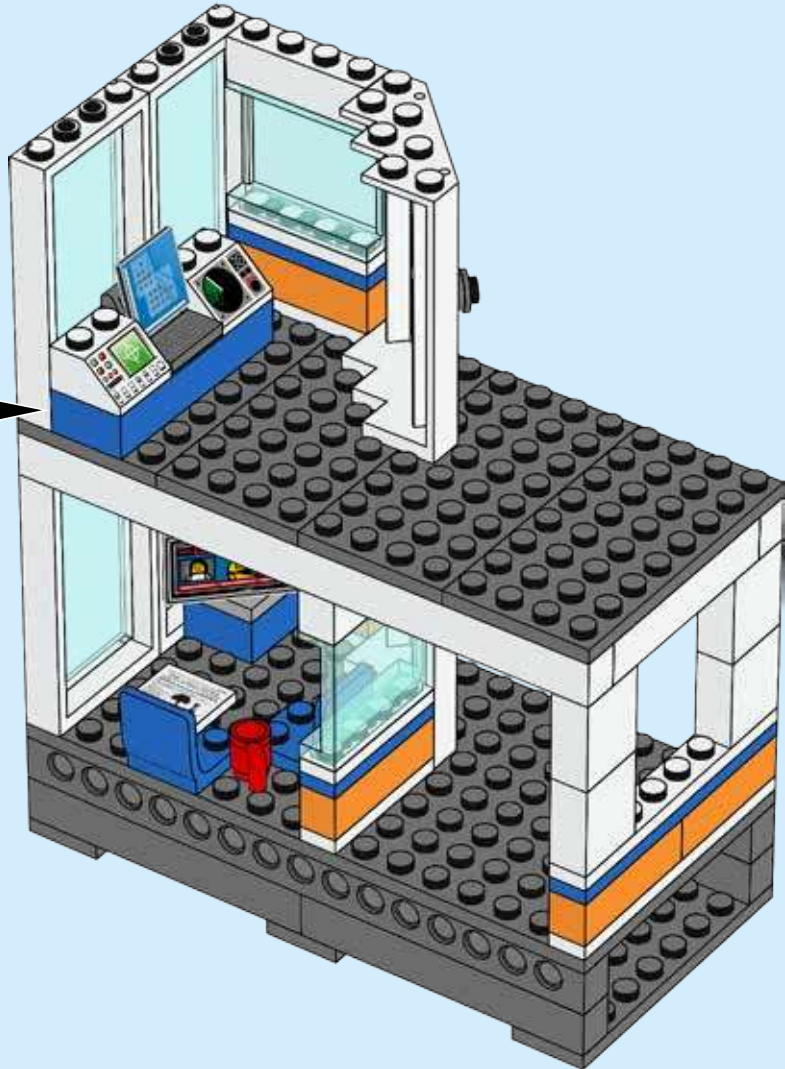
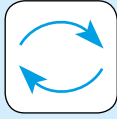



1x

28

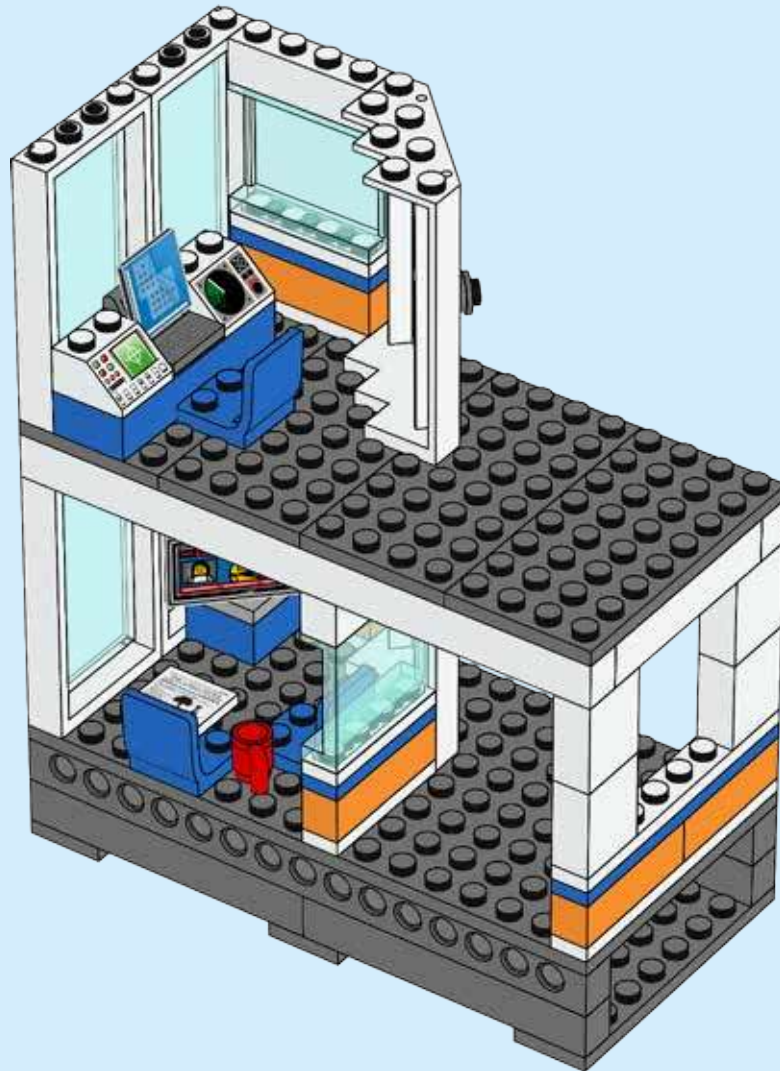

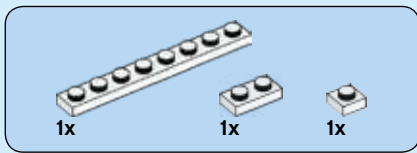

29

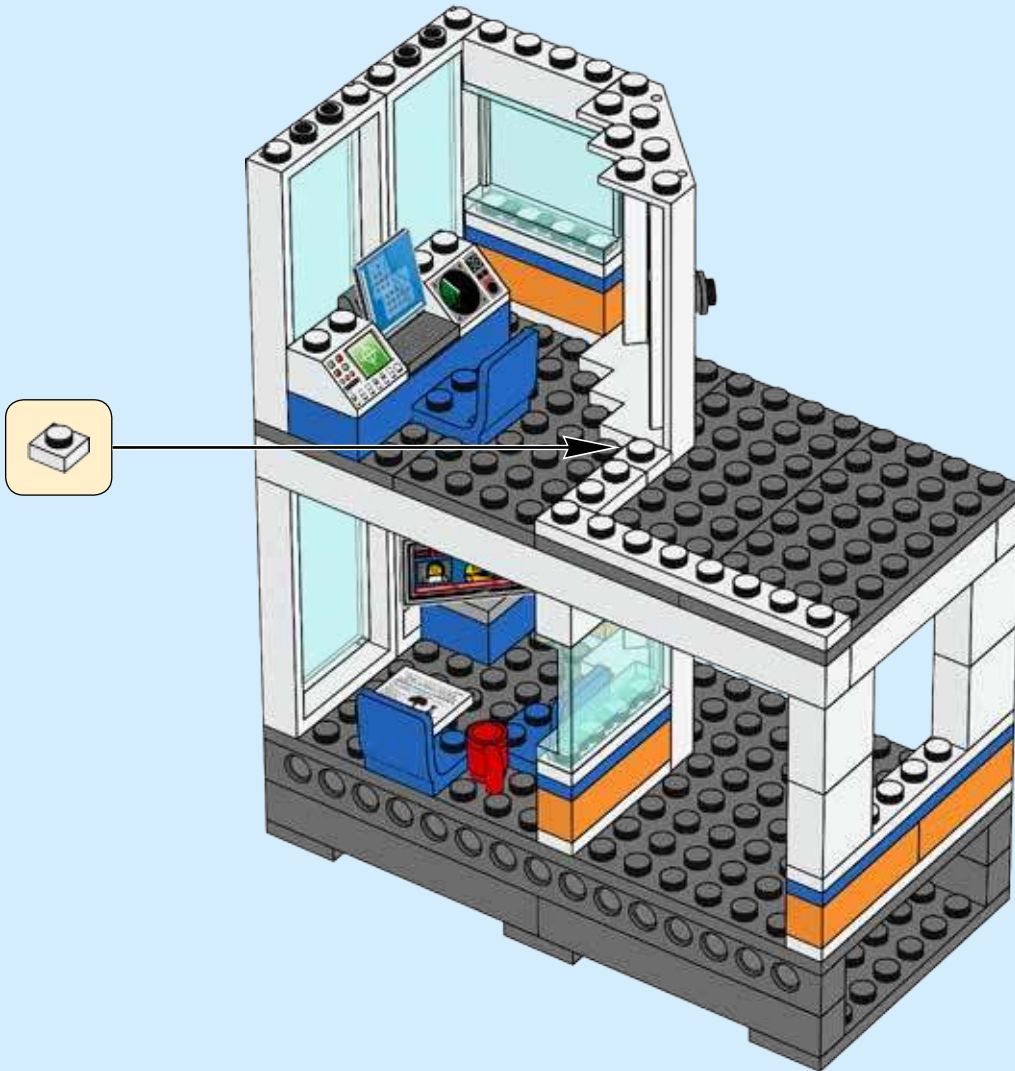



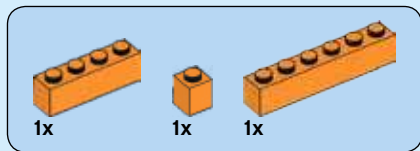

30

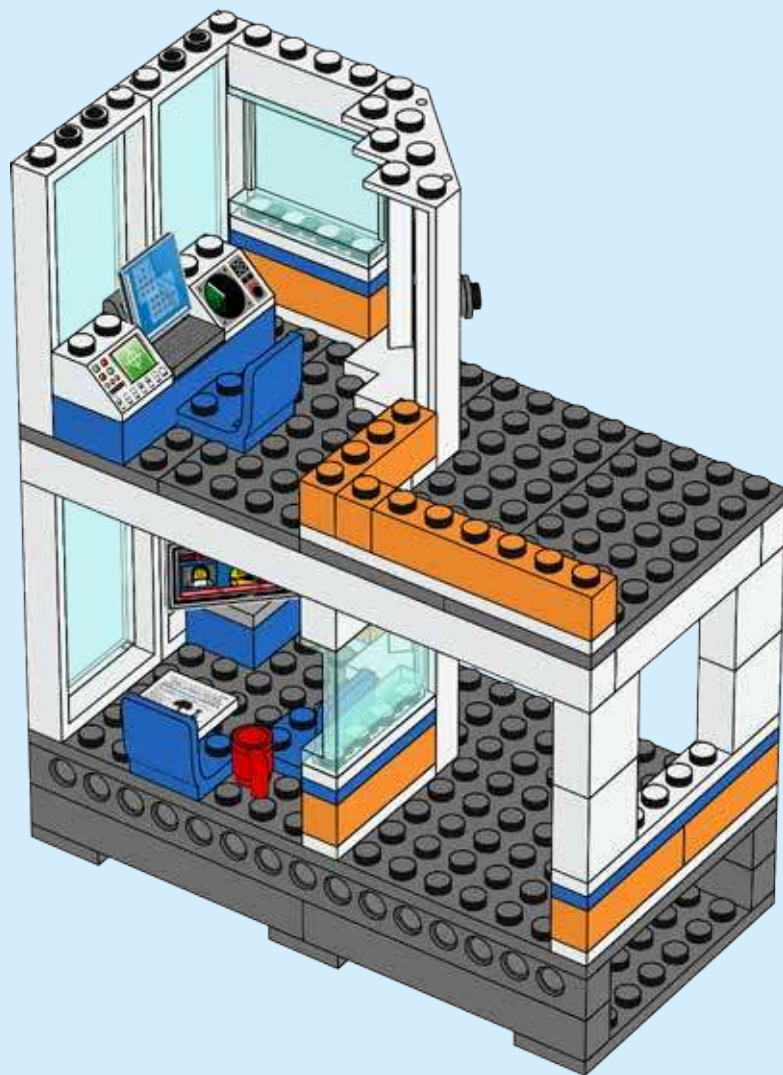



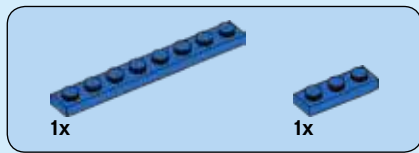

31

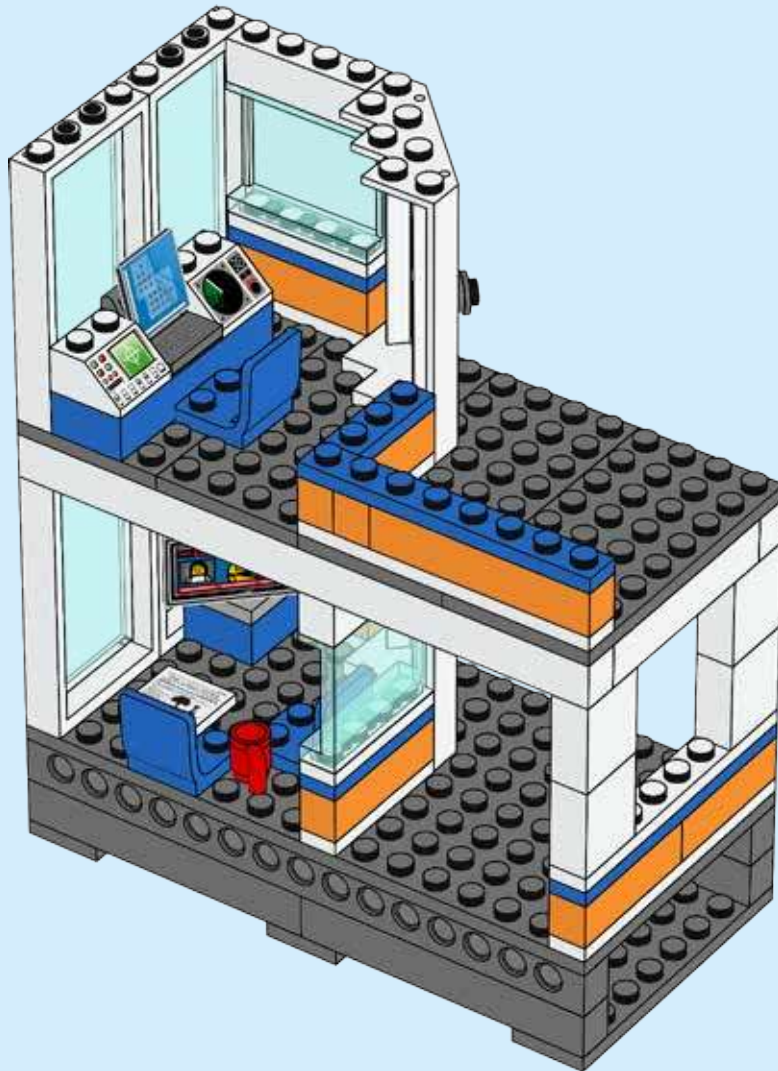

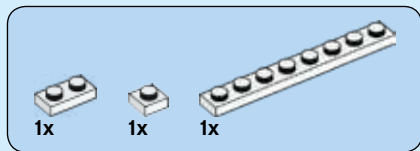

32

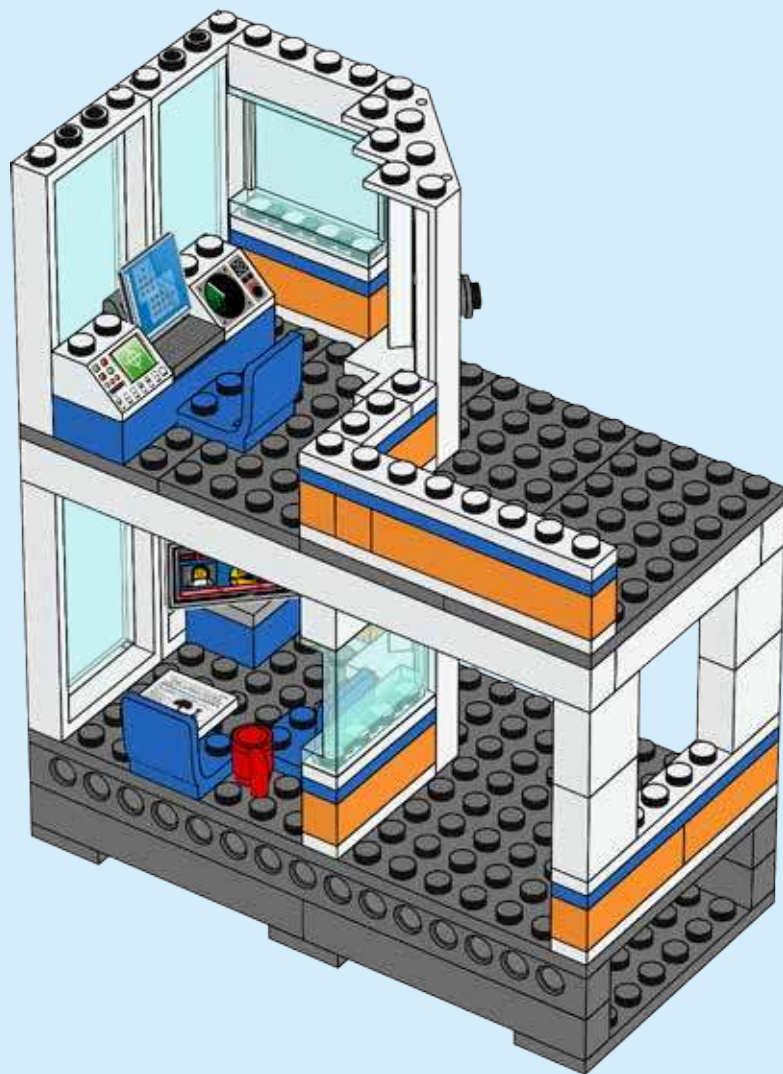

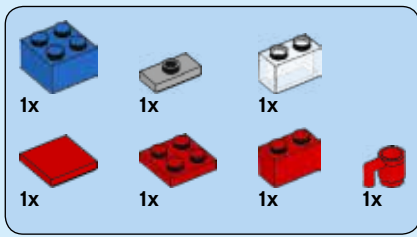

33

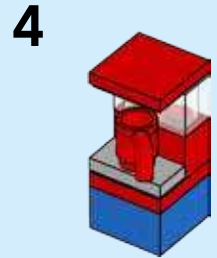
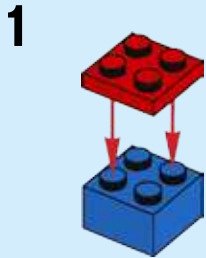

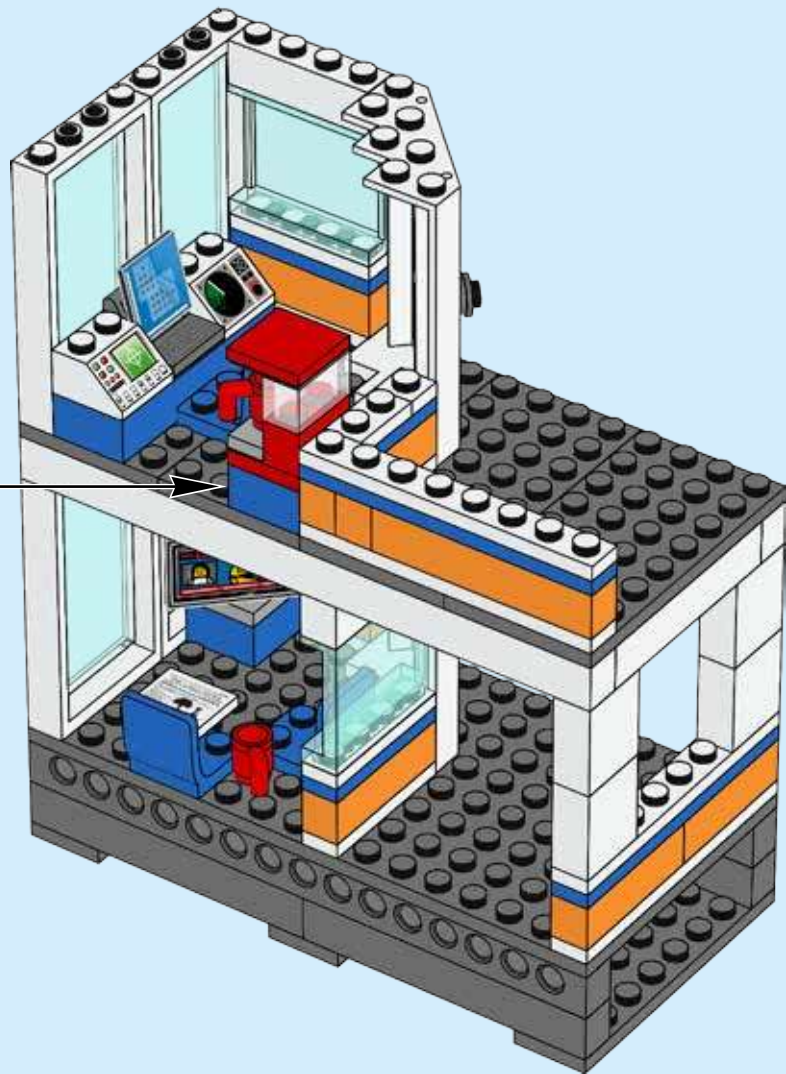

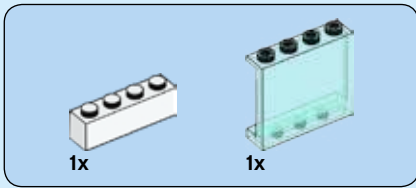

34

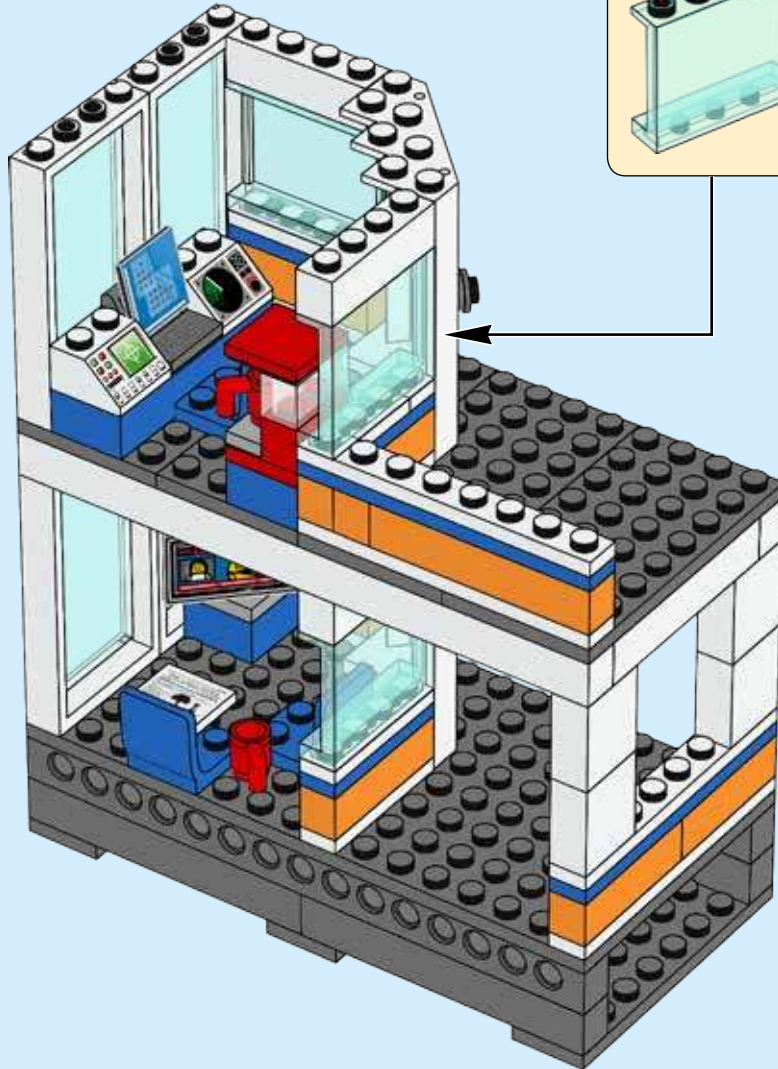
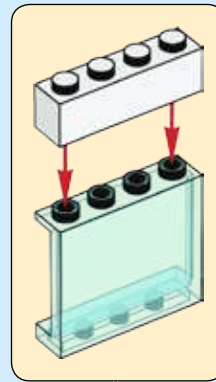



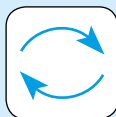
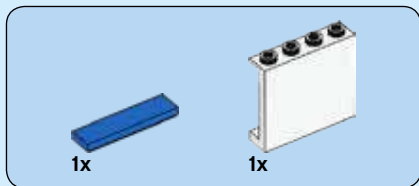

35

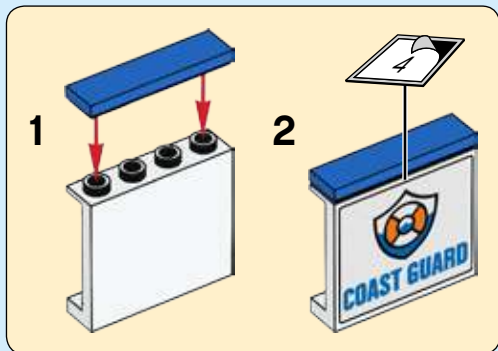



2x

36





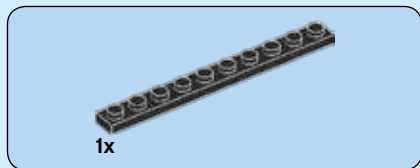

37



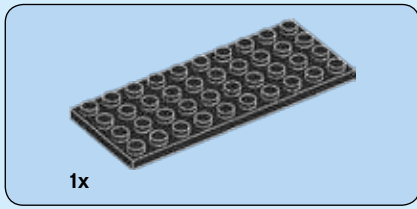

38



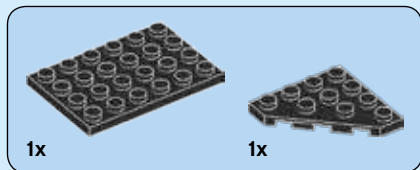

39





1x

40







4x

41





1x

42





2x



2x

43







2x

44





45

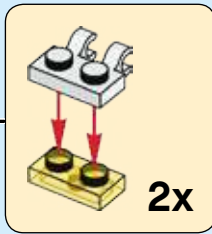

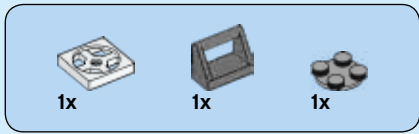

46

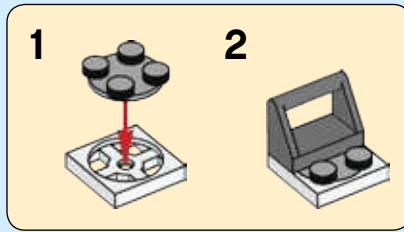

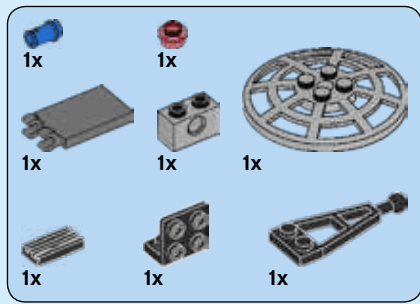

# 47

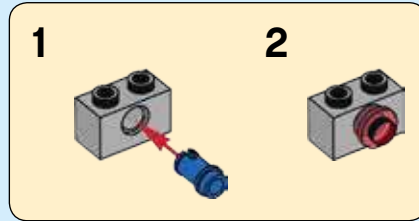

1



2



3

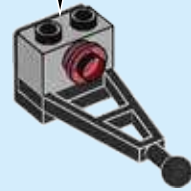

4



5

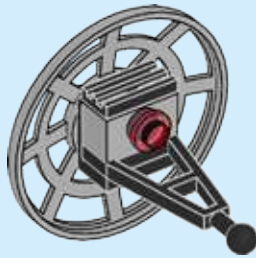

6

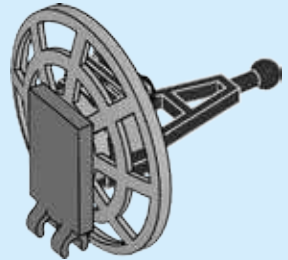
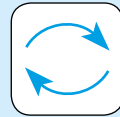





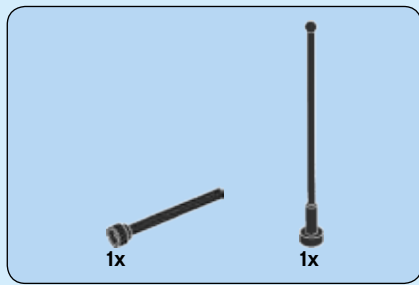

48









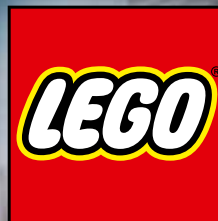

# CITY

## UNDERCOVER

**AVAILABLE NOW!**

[LEGO.com/videogames](http://LEGO.com/videogames)



www.pegi.info  
PROVISIONAL



PS4



XBOX ONE

© 2017 The LEGO Group.™ & © WBEL. (s17)



LEGO GAMES