





ASSEMBLY INSTRUCTIONS

6105

CAUTION :

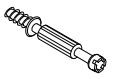
- BEFORE ASSEMBLING, READ ALL THE INSTRUCTION.
- ENSURE ALL COMPONENTS ARE PLACE ONTO CARDBOARD AS PROTECTION.
- CLEAN SURFACE WITH A DRY OR DAMP SOFT CLOTH.
- DO NOT USE ABRASIVE CLEANERS, DETERGENT OR CHEMICAL.

HARDWARE :

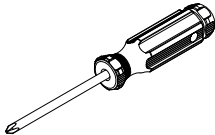
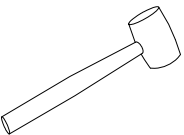
1	2	3	4	5	TOOLS REQUIRED :
					 
x 16 PCS	x 16 PCS	x 16 PCS	x 20 PCS	x 28 PCS	

COMPONENTS :

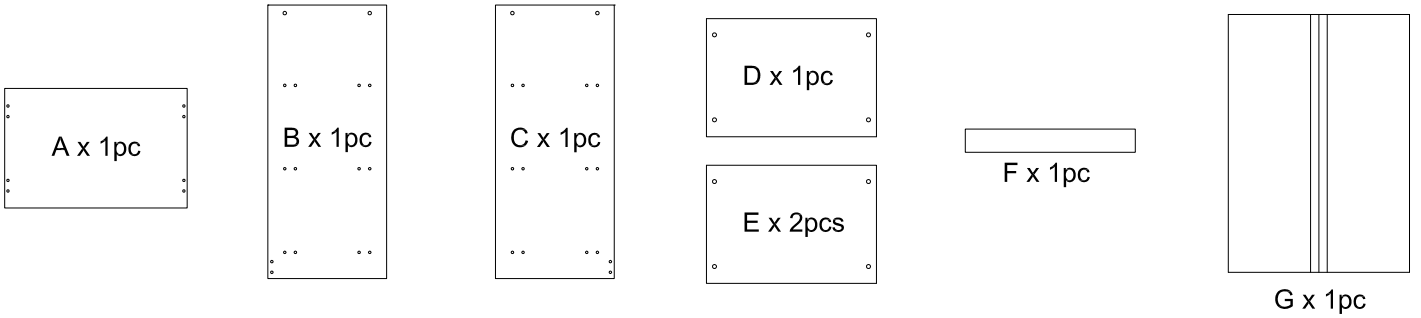

STEP 1

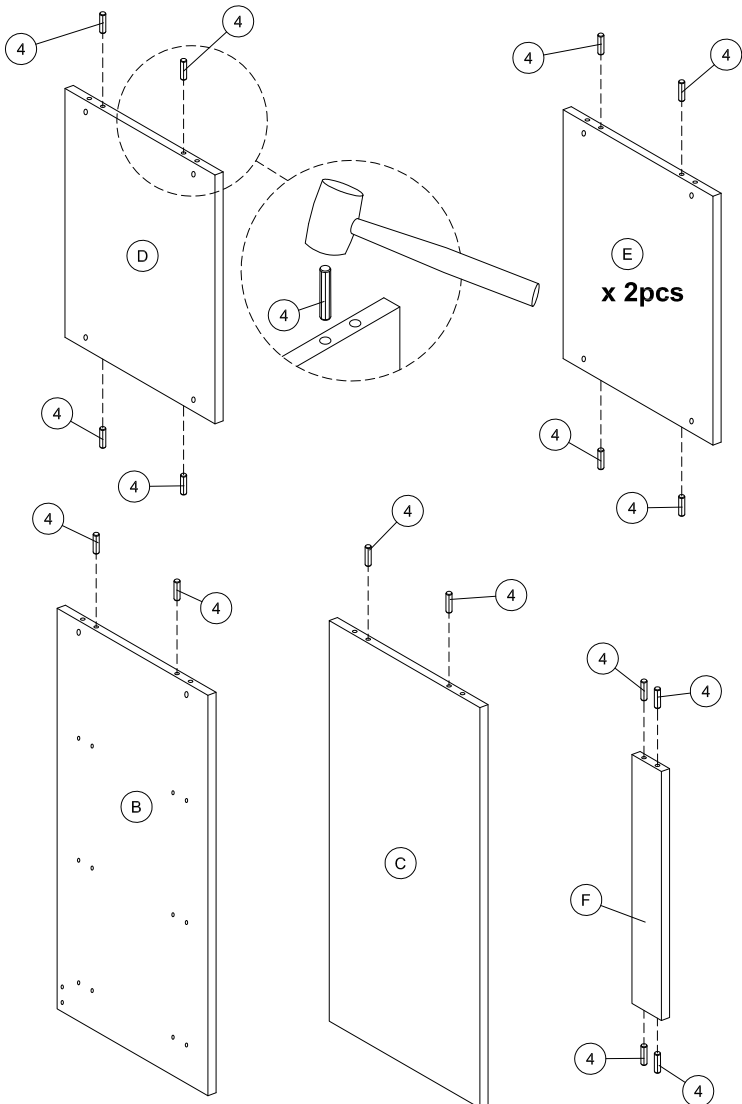

STEP 2

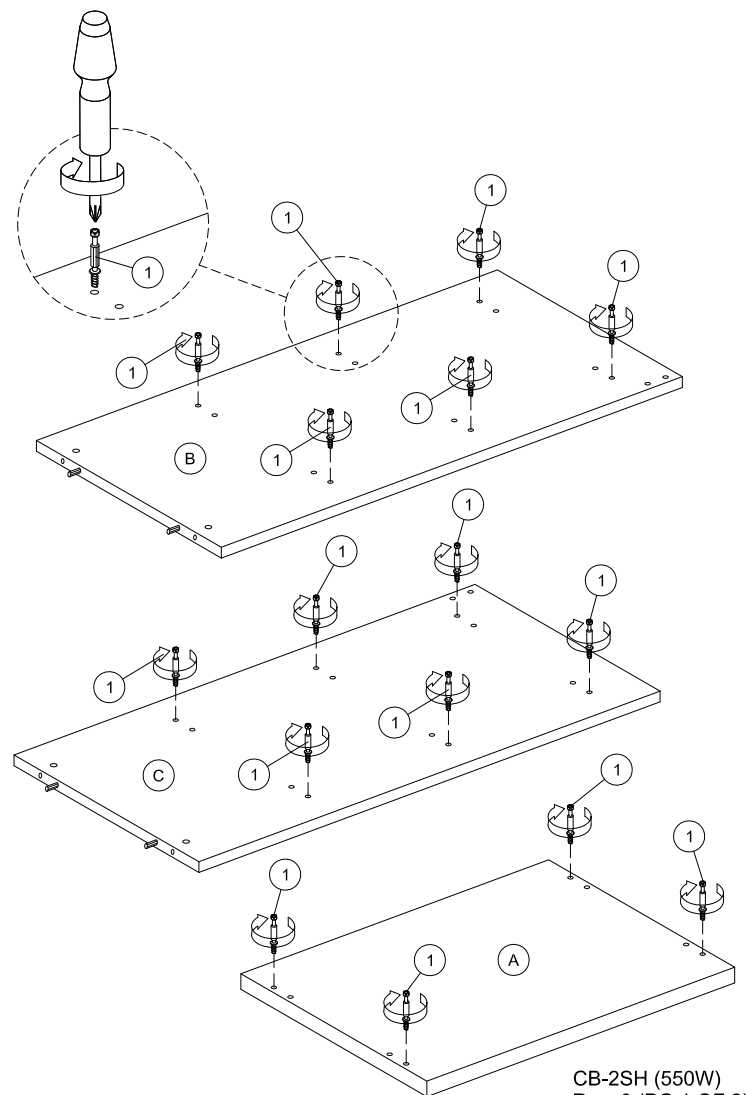

ASSEMBLY INSTRUCTIONS

STEP 3

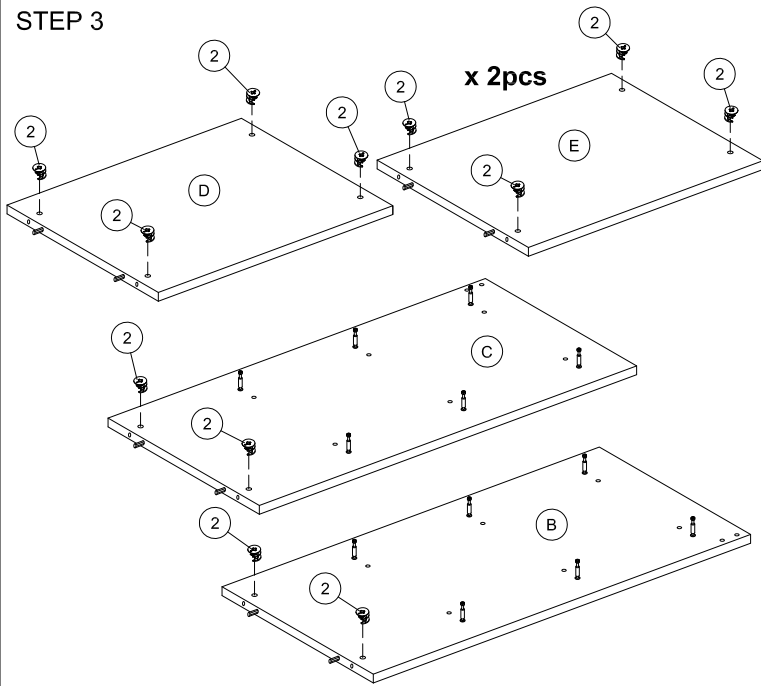

STEP 4

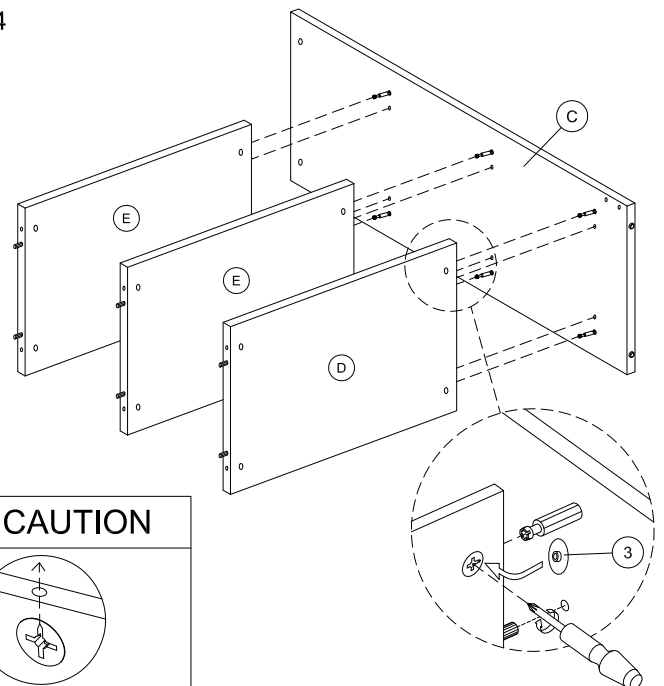

STEP 5

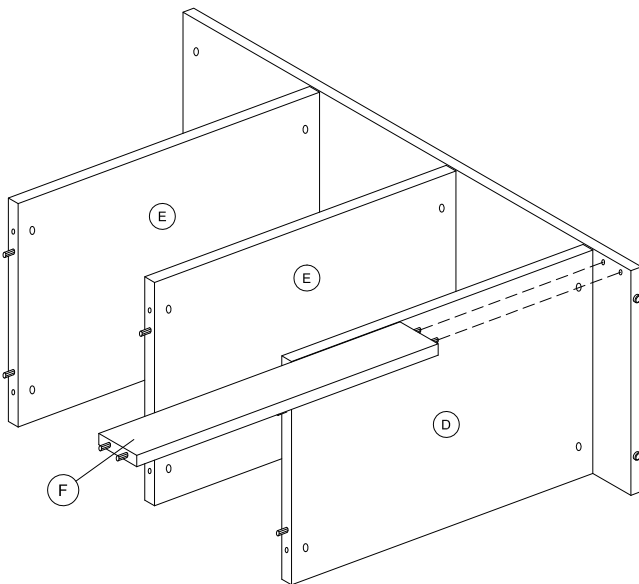

STEP 6

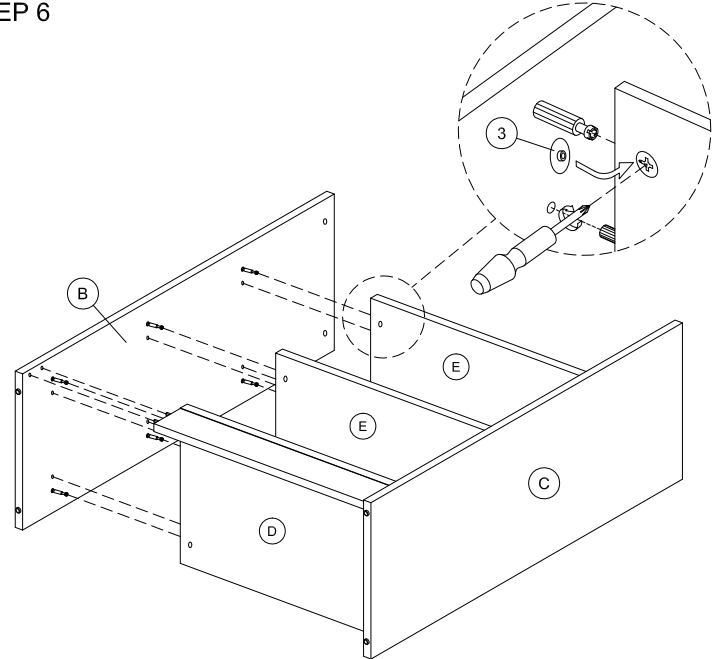

STEP 7

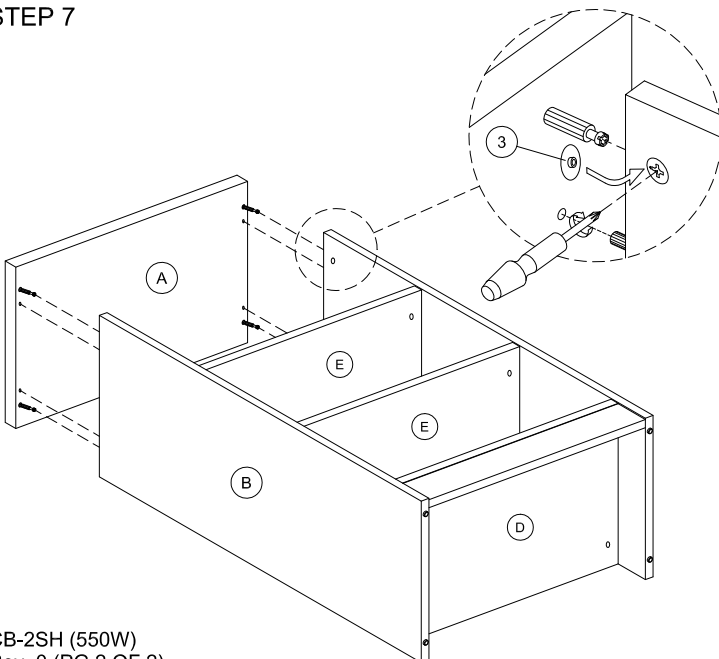

STEP 8

