

Contents

Getting started

Wearing the watch	1
Adjusting and Replacing the watch strap	1
Pairing your watch with your phone	5
Powering on/off and restarting the watch	7
Charging your watch	8
Buttons and gestures	10
Customizing the Down button	12
Adjusting screen brightness	12
Setting the vibration strength	12
Setting time and language	12
Enabling frequently used features	12
Unlocking your phone using your watch	13
Enabling Do not disturb mode	13
Connecting earbuds	13
Viewing the Bluetooth name and MAC address	14
Check the watch's version	14
Check the watch's SN	14
Updating the watch	14
Restoring the watch to its factory settings	15

App management

Getting notifications and deleting messages	16
Setting favorite contacts (using a watch to make/receive a call)	17
Answering or rejecting incoming calls	17
Checking your call log	18
Playing music	18
Using Stopwatch or Timer	19
Setting an alarm	19
Using Flashlight	20
Using the Barometer app	20
Using Compass	21
Weather reports	21
Finding your phone using your watch	21

Professional workouts

Starting a workout	23
Workout status	24
Tracking daily activities	25
Viewing the duration of moderate to high intensity activity	25

Recording workout routes	26
Syncing and sharing your fitness and health data	26
Fitness and health	
Monitoring your heart rate	27
Tracking sleep	31
Testing stress levels	31
Activity reminder	32
Enabling HUAWEI TruSleep™	32
Watch faces	
Changing watch faces	34
Setting Gallery watch faces	34
Installing, replacing, and deleting watch faces	36
Setting a standby watch face	37
Setting up dual time zones	37

Getting started

Wearing the watch

Attach the heart rate monitoring area of your watch on the top of your wrist, as shown in the following figure. To ensure the accuracy of heart rate measurement, wear your watch properly and do not wear it above the joint in your wrist. Do not wear it too loosely or too tightly but make sure that your watch is attached securely on your wrist.

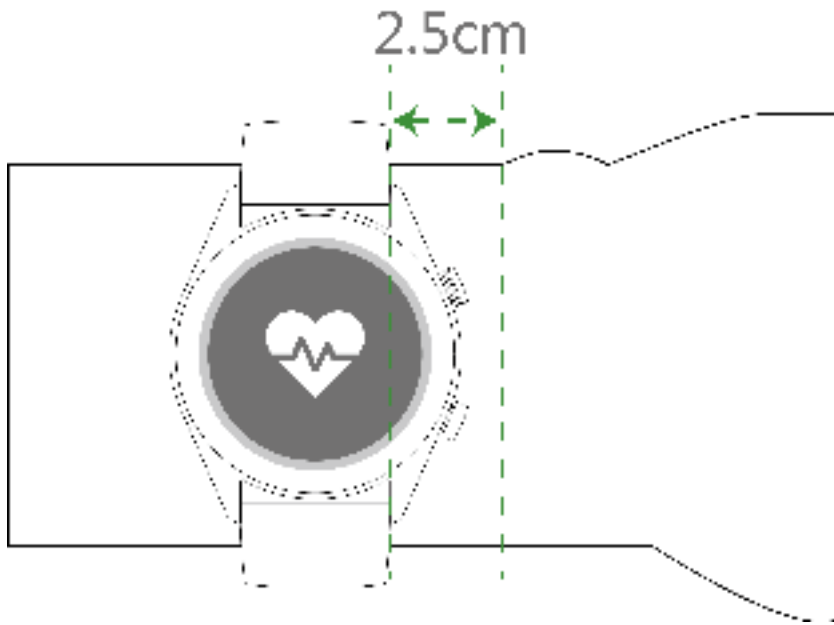

- i** • Your watch uses non-toxic materials that have passed strict skin allergy tests. Please rest reassured when wearing wear it. If you experience skin discomfort when wearing the watch, take it off and consult a doctor.
- Wear your watch correctly for greater comfort.
- You can wear your watch on either wrist.

Adjusting and Replacing the watch strap

Adjusting the strap

For watches with non-metallic straps and T-shaped buckles, you can adjust the strap to a comfortable fit depending on the circumference of your wrist.

If the strap is made of metallic materials, adjust it by performing the following:

Adjusting metal link straps

1. Use the screwdriver that comes with the watch to remove the screws from the links you want to remove.

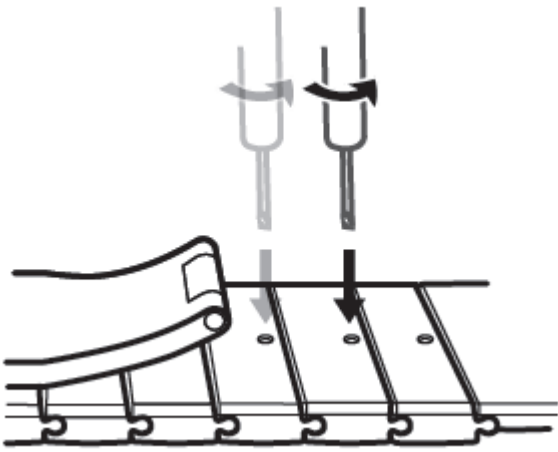

2. Remove a link from both sides of the clasp to make sure the watch face is still centered.

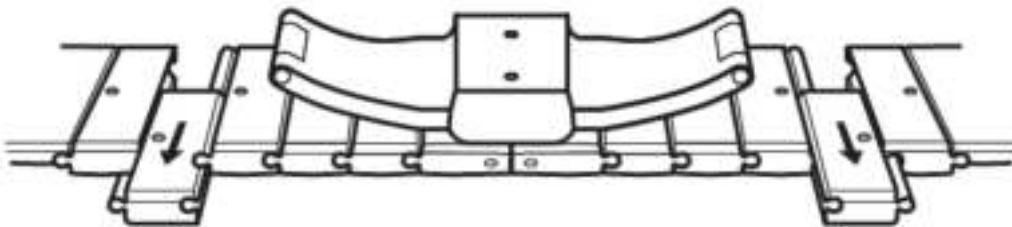

3. Re-assemble the strap.

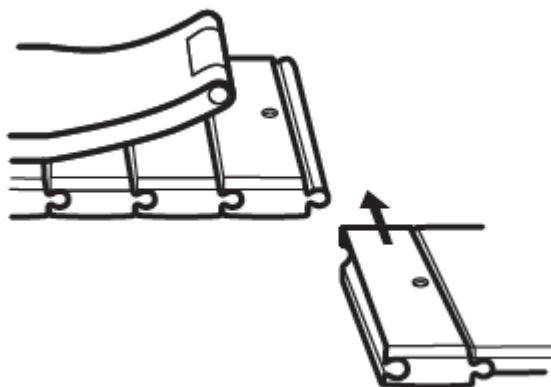

4. Put the screws back in.

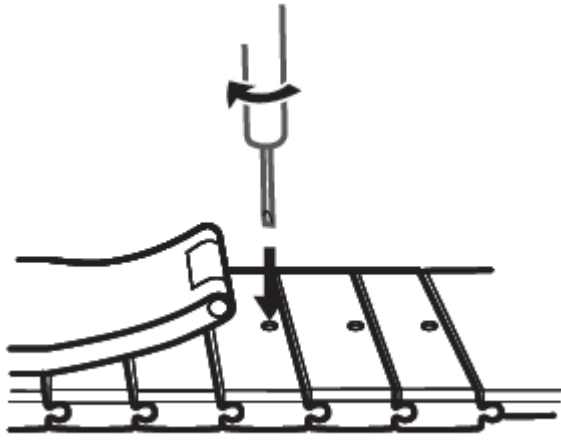

Adjusting metal mesh straps

1. Undo the clasp.



2. Pull the bottom plate upward so it is at a 90° angle with the strap.

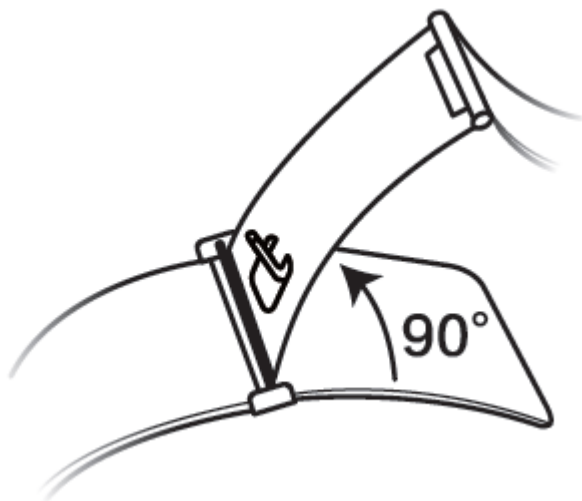

3. Slide the clasp to adjust the length.

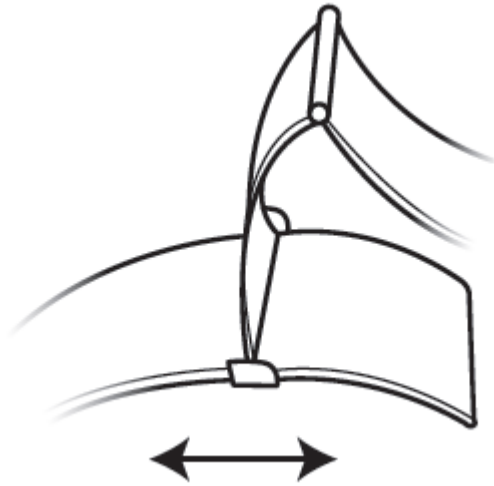

4. Align the plate with the grooves and clamp it back down. Finish by fastening the clasp.

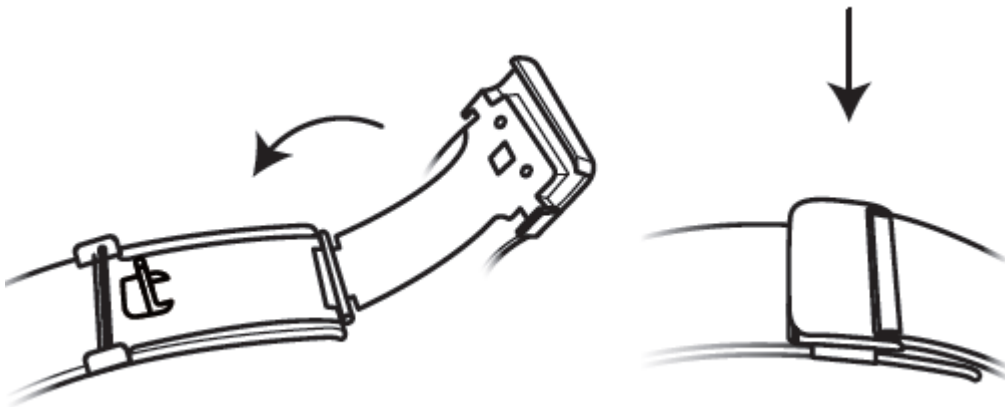

Removing and installing the strap

To remove a non-metallic strap, unlock the fastener, remove your current strap, and then release the spring pin, as shown in the following figure. Follow the steps in the reverse order to install a new strap.

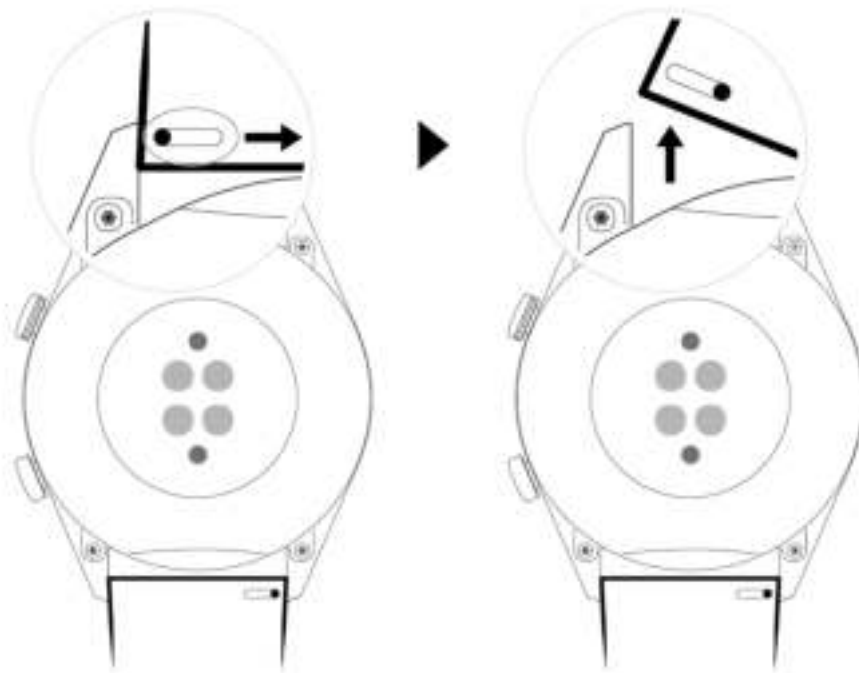

To remove a metal strap, perform the steps shown in the following figure. Follow the steps in the reverse order to install a new strap.

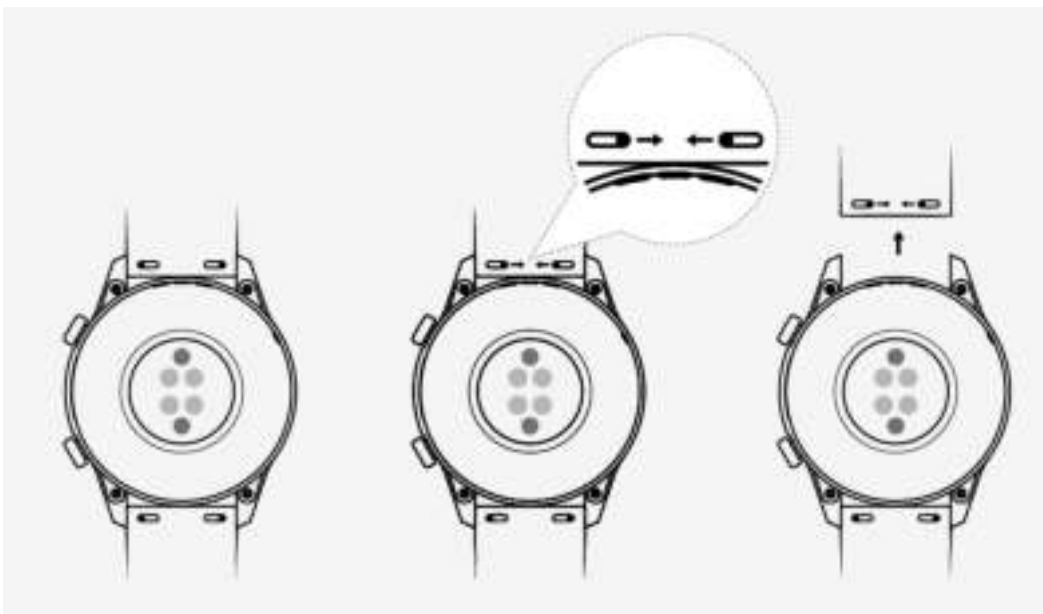

Pairing your watch with your phone

If you have just taken the watch out of the box, press the Up button and hold until your watch vibrates and displays a startup screen. The watch is ready to be paired via Bluetooth by default.

- **For Android users:**

- 1 Download and install the Huawei Health app from an app store. If you have already installed it, make sure that it is up-to-date.

- 2 Open the Huawei Health app and follow the onscreen instructions to grant required permissions to the app. Go to **Devices > Add > Smart Watch**, and touch the device you wish to pair.
- 3 Touch **PAIR** and the app will automatically search for nearby available Bluetooth devices. Once your watch is found, touch its name to start pairing.



- 4 When a pairing request is displayed on the watch screen, touch  to pair your watch and phone. Confirm the pairing on your phone as well.

• **For iOS users:**

- 1 Download and install the Huawei Health app from App Store. If you have already installed it, make sure that it is up-to-date.
- 2 Open the Huawei Health app, go to **Devices > + > Smart Watch**, and touch the device you wish to pair.
- 3 Touch **PAIR** and the app will automatically search for nearby available Bluetooth devices. Once your watch is found, touch its name to start pairing.



- 4 When a pairing request appears on your watch screen, touch  to pair your watch and phone.

HUAWEI WATCH GT2 (46 mm) follow these steps to pair:

- 1 Log in to the App Store on your phone and search Huawei Health. Download and install the app, and make sure it is fully updated.
- 2 On the phone go to Settings > Bluetooth. The watch should show up automatically, touch your device, then touch  to finish pairing.
- 3 Open the Health app and go to the settings screen, touch + in the upper right corner and select Smart watches. Select your device's model.
- 4 Touch PAIR and the app will automatically search for nearby available Bluetooth devices. Once your watch is found, touch its name to start pairing.



- 5 When a pairing request is displayed on the watch screen, touch  to pair your watch and phone. Confirm the pairing on your phone as well.

- When pairing for the first time, you can use your phone to scan the QR code on the watch screen to download the Huawei Health app.



- If your watch does not respond after you touch  to confirm the pairing request, press the Down button and hold to unlock your watch, and initiate a pairing procedure again.
- Your watch will display an icon on the screen to inform you that pairing was successful. It will then receive information (such as the date and time) from your phone.
- If the pairing failed, your watch screen will display an icon to inform you that pairing was unsuccessful. It will then return to the startup screen.
- A watch can be connected with only one phone at any given time, and vice versa. If you want to pair your watch with another phone, disconnect your watch from the current phone using the Huawei Health app, and then pair your watch with another phone using the Huawei Health app.

Powering on/off and restarting the watch

Powering on the watch

- When the watch is powered off, press and hold the Up button to power on the watch.
- When the watch is powered off, the watch will automatically power on if you charge it.
-  If you power on the watch when the battery level is critically low, the watch will remind you to charge it and the watch's screen will turn off after 2 seconds. You will be unable to power on the watch until you charge it.

Powering off the watch

- When the watch is powered on, press and hold the Up button, and then touch **Power off**.
- When the watch is powered on, press the Up button while on the home screen, swipe up or down until you find **Settings**, touch it, go to **System** > **Power off**, and then touch  to confirm.
- If the battery level is critically low, the watch will vibrate and then automatically power off.

Restarting the watch

- When the watch is powered on, press and hold the Up button, and then touch **Restart**.
- When the watch is powered on, from the home screen press the Up button, swipe until you find **Settings**, touch it, go to **System** > **Restart**, and then touch  to confirm your choice.

Force restarting the watch

- Press and hold the Up button for at least 16 seconds to force restart the watch.

Charging your watch

Charging

- 1 Connect the USB Type-C port and power adapter and then plug in the power adapter.
- 2 Rest your watch on top of the charging cradle, ensuring that the contacts on your watch and the cradle are aligned. Wait until the charging icon appears on your watch screen.
- 3 When your watch is fully charged, 100% will be displayed on the watch screen and the charging will stop automatically. If the battery level is below 100% and the charger is still connected to the watch, the charging will start automatically.

-  Use the dedicated charging cable, charging cradle, rated output voltage of 5 V, and rated output current of 1 A or higher to charge your watch.
- It is recommended that you lift the charging cradle to attach it to your watch. Ensure that the side of your watch with buttons is aligned with the charging port of the cradle. After the cradle and watch are connected properly, check to see if the charging icon is displayed. If you cannot see the charging icon, you may need to slightly adjust the position of the cradle until contact is established and the charging icon appears.
- Your watch will automatically power off when its battery level is too low. After it is charged for a while, your watch will automatically power on.

Charging time

Your watch will be fully charged within two hours. When the charging indicator displays 100%, the watch is fully charged. Disconnect your watch from the power adapter once it is fully charged.



- Charge your watch in a dry and well-ventilated environment.
- Before charging, make sure that the charging port and metal parts are clean and dry to prevent short circuits or any other risks.
- Before charging, make sure the charging port is dry. Wipe off any water or sweat stains.
- The charging cradle is not water resistant, so keep it dry at all times.
- It is recommended that the ambient temperature is between 0 and 45°C.
- To protect the battery, the charging current will be reduced if the ambient temperature is low, which will prolong the charging time without affecting the battery lifespan.

Checking the Battery Level

Use one of the following three methods to check the battery level:

Method 1: When your watch is connected to the charger, you can check the battery level on the charging screen that is displayed automatically. Press the Up button to exit the charging screen.

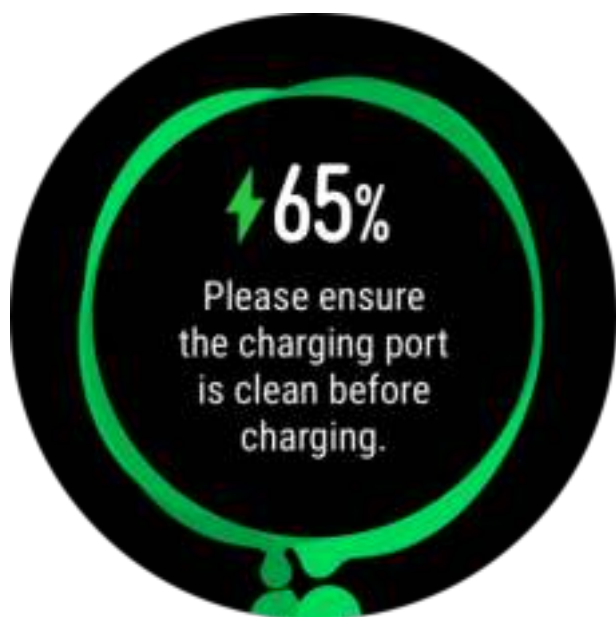

Method 2: Swipe the home screen from top to bottom and then check the battery level in the drop-down menu.

Method 3: Check the battery level on the device details screen in the Huawei Health app.



Buttons and gestures

The watch is equipped with a color touchscreen that is highly responsive to your touches and can be swiped in different directions.

Up button

Operation	Function	Remarks
Press	<ul style="list-style-type: none"> • Wake watch screen when the screen is off. • Access the app list screen from the home screen. • Return to the home screen. 	There are certain exceptional scenarios such as for calls and workouts.
Press and hold	<ul style="list-style-type: none"> • Power on your watch when the watch is off. • Access the restart/power off screen when the watch is on. 	

Down button

Operation	Function	Remarks
Press	Open the workout app. Access the customized feature you set.	There are certain exceptional scenarios such as for calls and workouts.

Button functions during a workout

Operation	Function
Press the Up button	Lock/unlock, mute, or end workout
Press the Down button	Switch screen.
Press and hold the Up button	Finish the workout.
Swipe up or down on the screen	Switch screen.
Touch the screen and hold	Show a different data type.

Gestures

Operation	Function
Touch	Choose and confirm.
Touch and hold on the home screen	Change the watch face.
Swipe up on the home screen	View notifications.
Swipe down on the home screen	View the shortcut menu.
Swipe left or right	View your heart rate data, workout data, weather information.
Swipe right	Return to the previous screen.

Wake the screen

- Press the Up button.
- Raise or rotate your wrist inwards.
- Swipe down on the home screen to open the shortcut menu. Enable **Show Time** and the screen will stay on 5 minutes.
-  You can enable the **Raise wrist to wake screen** function in the Huawei Health app by going to the details screen of your watch.

Turn off the screen

- Lower or rotate your wrist outwards.
- The screen will turn off automatically 5 seconds after the watch's screen is turned on if no operation is performed within this period of time. If any operation is performed, the screen will turn off 15 seconds after it is turned on.
-  From the home screen press the Up button and go to **Settings > Display > Advanced** to adjust the duration it takes for your watch to go to sleep and turn off the screen. The duration is set to **Auto** by default.

Customizing the Down button

- 1 From the home screen press the Up button and go to **Settings > Down button**.
- 2 Touch an app from the list. This app will be opened when you press the Down button.
 -  By default, pressing the Down button will open the Workout app.

Adjusting screen brightness

From the home screen press the Up button and go to **Settings > Display > Brightness** to adjust the screen brightness. Brightness is set to **Auto** by default, which automatically adjusts screen brightness based on your environment. Level 5 is the brightest setting and Level 1 is the dimmest setting.

Setting the vibration strength

1. From the home screen press the Up button, then go to **Settings > Strength**.
2. Swipe up or down on the screen and select **Strong**, **Soft**, or **None**. Touch **OK**. Your watch will then automatically return to the previous screen and vibrate with the strength that you set.

Setting time and language

You do not need to set the time and language on your watch. When the watch is connected with your phone, the time and language settings on your phone will be automatically synced to your watch.

If you change the language, time, or time format on your phone, the changes will be automatically synced to your watch when the watch and phone are connected.

-  For iOS users: Open your phone, go to **Settings > General > Language & Region**, set the language and region, and then connect the watch with your phone to sync the settings.
- For Android users: Taking EMUI 9.0 as an example, open your phone, choose **Settings > System > Language & input**, set the language, and then connect the watch with your phone to sync the settings.

Enabling frequently used features

After connecting your watch to your phone through the Huawei Health app, you can enable features for your watch in the app. Frequently used features include:

- HUAWEI TruSleep™

- Activity reminder
- Continuous heart rate monitoring
- Automatic stress test
- Notifications
- Weather reports
- Bluetooth disconnection reminder
- Raise wrist to wake screen

Unlocking your phone using your watch

Whether this feature is supported depends on your phone's specifications.

To enable this feature, perform the following: (The following example is with a phone running EMUI 9.0.)

- 1 Ensure that your phone and watch have been paired.
- 2 On your phone, go to **Settings > Security & privacy > Lock screen password > Smart unlock**. Set your lock screen password and add your watch as a trusted device.
- 3 You can now access your phone just by swiping on the phone screen and without having to enter a password.

 This feature will only work when your phone and watch are connected.

Enabling Do not disturb mode

To enable Do not disturb mode, swipe down on your watch's home screen, touch **No Disturb**, and then touch ✓ to confirm.

If your watch enters Do not disturb mode:

- 1 The watch will not vibrate for incoming calls, but you can still answer or reject incoming calls with the watch.
- 2 Messages and notifications will not be displayed on the watch, and the Raise wrist to wake screen feature will be disabled.

 If your watch does not support the calling feature, you will be unable to answer or reject incoming calls with the watch.

Connecting earbuds

- 1 From the home screen press the Up button and go to **Settings > Earbuds**.
- 2 Your watch will search automatically for the Bluetooth earbuds list for pairing. Select the name of your earbuds and follow the onscreen instructions to complete the pairing.

- If Bluetooth earbuds are connected via the watch and you answer a call from the watch, the audio will play from the watch's speaker. Audio for calls cannot go through the earbuds yet.
- If you would like to use your Bluetooth earbuds for calls, connect the earbuds to your phone and answer calls from your phone too.

Viewing the Bluetooth name and MAC address

To view the Bluetooth name and MAC address of your watch, use any of the following methods:

Method 1: On the home screen of your watch, press the Up button and go to **Settings > About**. The **Device name** is your watch's Bluetooth name. The 12 alphanumeric characters under **MAC** are your watch's MAC address.

Method 2: Your watch's MAC address is laser engraved on the back of the watch. The 12 alphanumeric characters next to "MAC:" are your watch's MAC address.

Method 3: Connect the watch to the phone and view the MAC address in the Huawei Health app.

Open the Huawei Health app, touch **Devices** and then your device name. Locate **Restore factory settings**, and the 12 alphanumeric characters next to it are your watch's MAC address.

Check the watch's version

From the home screen press the Up button, swipe until you find **Settings**, touch it, then touch **About**, and your watch's version information will be displayed.

Check the watch's SN

From the home screen press the Up button, swipe until you find **Settings**, touch it, then touch **About**, and your watch's SN (serial number) will be displayed under **SN**.

Updating the watch

Method 1:

Connect the watch to your phone using the Huawei Health app, open the app, touch **Devices**, touch the device name, choose **Firmware update**, then follow the onscreen instructions to update your watch if there are any new updates.

Method 2:

- For Android users: Open the Huawei Health app, touch **Devices**, touch the device name, then enable **Auto-download update packages over Wi-Fi**. If there are any new updates,

the watch will display update reminders. Follow the onscreen instructions to update your watch.

- For iOS users: Open the Huawei Health app, touch the profile picture in the upper-left corner on the home screen, touch **Settings**, then enable **Auto-download update packages over Wi-Fi**. If there are any new updates, the watch will display update reminders. Follow the onscreen instructions to update your watch.
-  During an update, the watch will automatically disconnect from your phone.

Restoring the watch to its factory settings

Method 1: From the home screen press the Up button, swipe until you find **Settings**, touch it, go to **System > Reset**, and then touch  to confirm. As all the data on your watch will be removed when you restore the watch to its factory settings, please exercise caution before confirming.

Method 2: Open the Huawei Health app, touch **Devices**, touch the device name, and then touch **Restore factory settings**.

App management

Getting notifications and deleting messages

Getting notifications

Ensure that the watch is paired with your phone using the Huawei Health app, then perform the following:

For Android users: Open the Huawei Health app, touch **Devices**, and then touch your device. Touch **Notifications** and enable **Notifications**. Turn on the switch for apps for which you want to receive notifications.

For iOS users: Open the Huawei Health app, touch **Devices**, and then touch your device. Touch **Notifications** and enable **Notifications**. Turn on the switch for apps for which you want to receive notifications.

Your watch will vibrate to notify you when a new message is displayed on your phone's status bar.

Swipe up or down on the watch screen to view message content. A maximum of 10 unread messages can be stored on your watch. If there are more than 10 unread messages, only the latest 10 messages will be displayed. Each message can be displayed on one screen.

-  • Your band can display messages from the following apps: SMS, Email, Calendar, and various social media platforms.
 - You are not able to reply directly on your watch when you receive an SMS message, WeChat message, or email.
 - Your watch will still receive notifications but will not alert you if your watch is in Do not disturb, Sleep mode, or it detects you aren't wearing it.
 - If you receive a new message when you are reading another message, your watch will display the new message.
 - When your watch is in Do not disturb or Sleep mode or during a workout, it will still receive notifications but will not alert you. You can swipe up on your watch home screen to view new messages.
 - If your phone and watch are connected, your phone will push an alert to your watch over Bluetooth when you receive an incoming call or message on your phone. Due to the slight delay in sending information over Bluetooth, your phone and watch will not receive the alert at exactly the same time.
 - Reminders and incoming call notifications on your watch won't be affected if other Bluetooth devices are also connected to your phone.
 - You are able to receive voice messages and images from third-party social media apps but you are unable to listen to voice messages or view images.

Deleting messages

To delete a message, swipe right on it. To delete all messages, touch **Clear** .

Setting favorite contacts (using a watch to make/receive a call)

- 1 Open the Huawei Health app and touch **Devices**. Touch your device name to access the watch settings screen. Touch **Favorite contacts**.
- 2 Then perform the following:
 - Touch **ADD** and your phone contacts list will appear. Then select the contacts you wish to add.
 - Touch **Sequence** to sort the contacts you have added.
 - Touch **Remove** to remove a contact you have added.
- 3 From the home screen press the Up button, swipe until you find **Contacts** to call your favorite contacts from your watch.
 -  1 A maximum of 10 favorite contacts can be added to your watch.
 - 2 Make sure your watch and phone are connected before making a call from you watch.
 - 3 To adjust the volume during the call, touch the speaker icon on the screen or press the Up button or Down button.
 - 4 A maximum of 30 call records can be saved.

Answering or rejecting incoming calls

When your watch is connected to your phone and you receive a call, your watch will vibrate and display the caller's number and name. You can choose to answer or reject the call.

-  • The HUAWEI WATCH GT 2e supports only incoming call notification and call rejection.
 - The incoming call information displayed on your watch matches the information displayed on your phone. If the caller is unknown, the phone number will be displayed. If you have the number saved in your contacts, the caller's name will be displayed.
 - Your watch will not vibrate and turn on its screen upon incoming calls when **Do not disturb** is enabled or when you are not wearing your watch.
 - You can stop the watch from vibrating by pressing the Up button.
 - You can reject an incoming call by touching the reject icon on the watch screen.
 - You are able to adjust the volume during calls.

Checking your call log

- 1 From the home screen press the Up button, swipe until you find **Call Log**, touch it to view call logs.
- 2 Touch an entry to call them back.
- 3 Swipe down to the bottom of the screen and touch **Clear** to clear all call logs.

Playing music



 The music feature is only available with Android.

- 1 Open the Huawei Health app, touch **Devices**, touch the device name, and then touch **Music**.
- 2 Touch **Manage music > Add songs**, select the music as needed from the list, and touch ✓ in the upper-right corner of the screen.
- 3 From the home screen press the Up button, swipe until you find **Music**, and then touch it.
- 4 Choose music that you have added in the Huawei Health app and then touch the play icon to play the music.

-  • Music can be played through third-party social media apps, only MP3 and AAC (LC-AAC) files can be added to the watch locally.
 - You can also create a playlist by performing the following: Touch **New playlist** in the Huawei Health app and then add the music that has been synced to your watch to the playlist.
 - On the music playback screen of your watch, you can switch between songs, adjust the volume, and select a playback mode, such as Play in order, Shuffle, Repeat the current song, and Repeat list. Swipe up to view the music list, touch the Settings icon in the lower-right corner of the screen to delete music, connect the watch to Bluetooth earphones, control the music playback on your watch, or control music playback on your phone. Using your watch to control the music playback on your phone is available only on Android phones.
 - To use your watch to control music playing on your phone, open the Huawei Health app, touch **Devices** and touch your device's name, touch **Music** and enable **Control phone music**.
 - You can use your watch to control music playback in third-party music apps on your phone.
 - The HUAWEI WATCH GT 2e music playback function can be used only after a Bluetooth headset is connected to the phone.



Using Stopwatch or Timer

Stopwatch

From the home screen press the Up button, swipe until you find **Stopwatch**, and then touch it. Touch  to start timing. Touch  to reset the stopwatch. Swipe right on your watch screen to exit Stopwatch.

Timer

From the home screen press the Up button, swipe until you find **Timer**, and then touch it. By default, there are 8 available countdown modes: 1 minute, 3 minutes, 5 minutes, 10 minutes, 15 minutes, 30 minutes, 1 hour, and 2 hours. Choose a countdown mode depending on the situation.

Touch  to start the countdown, touch  to pause the countdown, and touch  to stop the countdown.

You can also customize the timer. On the Timer screen, touch **Custom**, set the time, and touch  to start the countdown.

Swipe right on your watch screen to exit Timer.

Setting an alarm

You can use the Huawei Health app to set a Smart alarm or an Event alarm for your watch. The Smart alarm will wake you up if it detects that you are in a light sleep during a preset period. This helps to gradually wake up your brain and make you feel more refreshed.

Method 1: Setting an alarm using your watch

- 1 From the home screen press the Up button, swipe until you find **Alarm**, touch it, and then touch **+** to add an alarm.
- 2 Set the alarm time and repeat cycle and touch **OK**.
- 3 Touch an alarm to edit or delete it.
 -  If you do not set the repeat cycle, the alarm is a one-time alarm by default.
 - Your device will currently only vibrate but not ring to inform you.

Method 2: Setting a Smart/Event alarm using the Huawei Health app

For Android users:

- 1 Open the Huawei Health app, touch **Devices**, touch your device name, and then go to **Alarm > SMART ALARM**, or go to **Alarm > EVENT ALARMS**.
- 2 Set the alarm time, tag, and repeat cycle.
- 3 Touch  in the upper-right corner to save the settings.

4 Swipe down on the home screen to ensure that the alarm settings are synced to your watch.

5 Touch an alarm to edit or delete it.

For iOS users:

1 Open the Huawei Health app, touch **Devices**, and then touch your device name from the device list.



2 Go to **Alarm > Event Alarms** or go to **Alarm > Smart Alarm**.

3 Set the alarm time, tag, and repeat cycle.

4 Touch **Save**.

5 Swipe down on the home screen to ensure that the alarm settings are synced to your watch.

6 Touch an alarm to edit or delete it.

-  • Event alarms set on your watch can be synced to the Huawei Health app. You can set a maximum of five Event alarms.
- You can only set one Smart alarm for your watch.
- The Event alarm will ring at the specified time. If you set a tag for the Event alarm, the watch will display the tag. Otherwise, only the time will be displayed.
- When an alarm rings, touch  on your watch screen, press the up button, or swipe right on your watch screen to snooze for 10 minutes. To turn off the alarm, touch  on your watch screen or press and hold the Up button.
- When an alarm rings, the alarm will automatically turn off after snoozing three times if no other operations are performed.
- Currently, only alarms set on on Huawei or Honor phones running EMUI 8.1 or later or Magic UI 2.0 or later can be synced to the watch.

Using Flashlight

From the home screen press the Up button, swipe until you find **Flashlight**, and then touch it to turn on the flashlight. Touch the screen to turn off the flashlight and touch the screen again to turn it on. Swipe right on your watch screen to exit Flashlight.

Using the Barometer app

You can check the altitude and atmospheric pressure of your current location on your watch.

From the home screen press the Up button, swipe until you find **Barometer**, and touch it to check the altitude and air pressure of your current location and a graph showing atmospheric changes of the current day.

Altitude:

Altitude measurement range: -800 to 8800 meters.

Air pressure:

Air pressure measurement range: 300 to 1100 hPa.

Swipe up or down to check altitude and air pressure respectively.

Using Compass

From the home screen press the Up button, swipe until you find **Compass**, touch it, and then follow the onscreen instructions to calibrate it. After it is successfully calibrated, your watch will display a compass dial.

Weather reports

You can check your watch to find out about the weather in your local area.

Method 1: Viewing the weather information on a watch face that can display weather data

Ensure that you are using a watch face that displays weather information, then you can check the latest weather information on the home screen.

Method 2: Viewing the weather information on the weather screen

Swipe right on the screen until you find the weather screen, then you can check your location, the latest weather, temperature

Method 3: Viewing the weather information in the Weather app

From your home screen press the Up button, swipe until you find **Weather**, touch it, and then you can check your location, the latest weather information, temperature, and air quality.

-  • To check the weather information on your watch, you are advised to open the Huawei Health app, touch **Devices**, touch your device name, and then enable **Weather reports**. You can set the **Temperature unit** to **Celsius °C** or **Fahrenheit °F**.
- The weather information displayed on your watch may differ slightly from that displayed on your phone, since the information is collected from different weather service providers.
- Ensure that you have granted your phone and the Huawei Health app the permission to access your location. For versions earlier than EMUI 9.0, select **Use GPS, WLAN, and mobile networks** as the positioning mode instead of **Use GPS only**.

Finding your phone using your watch

From the home screen press the Up button, swipe until you find **Find my phone**, or swipe down on the home screen and touch **Find Phone**. An animation will be displayed on the

screen. If your phone is within Bluetooth range, it will play a ringtone to alert you, even in Silent mode.

Touch your watch screen or unlock your phone screen to stop playing the ringtone.

 This feature will only work when your phone and watch are connected.

Professional workouts

Starting a workout

Your watch supports multiple workout modes. Choose a workout mode and start exercising.

Running Courses

The watch has been preinstalled with a series of running courses, from entry-level to advanced, that provide personalized and real-time guidance. You can choose different courses on your watch.

- 1 From the home screen press the Up button, swipe until you find **Workout**, touch it, choose **Running courses**, choose a course that you want to use, and then start running as prompted by your watch.
 - 2 During the workout, press the Up button to pause or end the running course, lock the screen, or adjust the volume for prompts during the workout. Press the Down button to switch between screens and view different workout data.
 - 3 After a workout, touch **Workout records** to view detailed workout records, including training effects, overall performance, speed, steps, total height, heart rate, heart rate zone, cadence, pace, and VO₂max.
-  To view detailed workout data, you can also open the Huawei Health app and touch **Exercise records**.

Starting a workout

Starting a workout using your watch:

- 1 From the home screen press the Up button, swipe until you find **Workout**, and then touch it.
- 2 Swipe up or down until you find your workout type. Before a workout, you can touch the Settings icon located next to each workout mode to configure target, reminders, and display settings.

 There is no Settings icon located next to Triathlon mode. In Triathlon mode, press the Down button to move to the next form.
- 3 Touch the Start icon to start a workout. During a workout, touch and hold the workout data screen until the watch vibrates, touch any workout data (such as heart rate, speed, distance, and time), and then choose what to display on the screen in real time.
- 4 During the workout, press the Up button to pause or end the running course, lock the screen, or adjust the volume for prompts during the workout. Press the Down button to switch between screens and view different workout data. (Take Outdoor Run mode as an example. During the workout, you can view a range of data displayed next to Heart rate, Pace, Distance, Time, Steps, Cadence, Total calories, and Total climbing. Different workout modes display different types of data.)
- 5 After a workout, press the Up button and touch the stop icon, or hold the Up button to end a workout session. Touch **Workout records** to view detailed workout records.

Starting a workout using the Huawei Health app:

To start a workout using the Huawei Health app, you need to bring your phone and watch together to ensure that they are connected properly.

- 1 Open the Huawei Health app, touch **Exercise**, choose a workout mode, and then touch the Start icon to start a workout.
- 2 Once you have started a workout, your watch will sync and display your workout heart rate, step count, speed, and time.
- 3 During a workout, the Huawei Health app displays workout time and other data.

-  If the workout distance or time is too short, the results will not be recorded.
 - To avoid draining your battery, make sure you hold the stop icon after a workout to end it.
 - Connect the watch to the phone using the Huawei Health app and start a workout in the app. When you start it from the app, the data between the watch and the app can sync. During an outdoor workout, heart rate, pace, and distance data will be synced from the watch to the app. For an indoor workout, heart rate data will be synced from the watch to the app while pace and distance data will be calculated by the app.
 - After a workout, open the Huawei Health app, touch **Exercise records** to view detailed workout data. Touch and hold a record to delete it from the app. This record will still be available on your watch. Up to 10 workout records can be saved on your watch. If you have more than 10 records, the oldest ones will be overwritten by new ones. Records on the watch cannot be deleted manually. You can reset your watch to its factory settings to clear your workout records. However, this will also clear any other data on your watch as well.

Workout status

The Workout status app on your watch can demonstrate your fitness status variation and your training load from the last seven days. You can review and modify your current workout plan with the help of this app. The app can also demonstrate your recovery time, high efficiency levels, peak status, training interruptions, and low efficiency levels. On the Training load screen, you can view your training load from the last seven days. Training load is classified as High, Low, or Optimal, and you can determine your level based on your fitness status.

The Workout status app mainly tracks your training load and VO₂max variations.

The watch collects your training load from workout modes which track your heart rate, such as running, walking, cycling, and climbing, and collects your VO₂max value when you start an outdoor running workout. The watch cannot display your workout status if it has not collected any VO₂max values. VO₂max variation will be displayed only if you use Outdoor

Run mode at least once a week (at least 2.4 kilometers within 20 minutes for each workout), and the watch collects at least two $VO_2\text{max}$ values with an interval of more than a week.

From the home screen press the Up button, swipe until you find **Workout status**, touch it, and then swipe up on the screen to view your workout status.

- Fitness status ($VO_2\text{max}$) variation is an important indicator of your workout status. Your watch will display your $VO_2\text{max}$ variation and your workout status only if you use Outdoor Run mode at least once a week, and the watch collects at least two $VO_2\text{max}$ values with an interval of more than a week.

Tracking daily activities

As your watch comes equipped with a motion sensor, it can track and display your steps, amount of calories burned, activity intensity, and standing times.

Wear your watch correctly for it to automatically record data relating to calories, distance, steps, duration of moderate to high intensity activities, and other activities.

You can view activity records by performing the following:

Method 1: Viewing activity records on your watch

From the home screen press the Up button, swipe until you find **Activity records**, touch it, and then you can swipe up or down to view data relating to calories, distance, steps, duration of moderate to high intensity activities, and other activities.

Method 2: Viewing activity records using the Huawei Health app

Open the Huawei Health app and view activity records on the home screen.

- To view your activity records using the Huawei Health app, ensure that the watch is connected to your phone.
- Workout data on your watch can be synced to the Huawei Health app, but data recorded in the app cannot be synced to your watch.

Viewing the duration of moderate to high intensity activity

Viewing the duration of moderate to high intensity activity

From the home screen press the Up button, swipe until you find **Activity records**, touch it,

and then the duration of moderate to high intensity activity is displayed next to . (Taking

 **25/30** as an example, it indicates that you have done 25 minutes of moderate to high intensity activity during that day. The recommended duration is 30 minutes per day.)

-  Android users can also check the duration of moderate to high intensity activity on the home screen of the Huawei Health app. The data displayed in the Huawei Health app is collected from both your phone and watch. Therefore, there is nothing to be concerned about if there is a data discrepancy between the app and your watch.

Recording workout routes

The watch features built-in GPS. Even if disconnected from your phone, the watch can still record your workout routes when you start Outdoor Run, Outdoor Walk, Outdoor Cycle, Climb, and other outdoor modes.

-  Different models support different outdoor workout modes.

If you cannot view workout routes on your watch, sync the workout data to the Huawei Health app and view the workout routes and other detailed workout data under **Exercise records** in Huawei Health.

Syncing and sharing your fitness and health data

You can share your fitness data to third-party apps and compare with your friends.

For Android users:

To share your fitness data to a third-party app, open the Huawei Health app, go to **Me > Settings > Data sharing** and select the platform you want to share to. Follow the onscreen instructions specific to each platform.

For iOS users:

To share your fitness data to a third-party app, open the Huawei Health app, go to **Discover > Third party services** and select the platform you want to share to. Follow the onscreen instructions specific to each platform.

Fitness and health

Monitoring your heart rate

The HUAWEI WATCH GT 2 features an optical heart rate sensor, which can monitor and record your heart rate all day. To use this feature, you need to enable **Continuous heart rate** in the Huawei Health app.

- i** When the watch detects that the user has fallen asleep, it will switch to use the non-visible light to measure your heart rate, letting you have a good nights sleep.

Heart rate measurement

- 1 Keep your arm still and wear your watch correctly.
 - 2 From the home screen press the Up button, swipe until you find **Heart rate**. Touch **Heart rate**. The watch will then measure your current heart rate.
 - 3 To pause the heart rate measurement, swipe right on your watch screen.
It usually takes approximately 6 to 10 seconds to display the first measurement value (1 to 2 seconds if **Continuous heart rate monitoring** is enabled in the Huawei Health app and **MONITORING MODE** is set to **Real-time**), and the data updates every 5 seconds afterward. A complete measurement takes approximately 45 seconds to complete.
- i** To guarantee a more accurate heart rate measurement, wear the watch correctly and ensure the strap is fastened. Make sure that your watch is secure on your wrist. Ensure that the watch body is in direct contact with your skin without any obstructions.



Heart rate measurement during an individual workout

During a workout, your watch can display your real-time heart rate and heart rate zone, and notify you when your heart rate exceeds the upper limit. For the best training result, you are advised to choose a workout based on your heart rate zone.

- Setting the heart rate zone calculation method

The heart rate interval can be calculated based on the maximum heart rate percentage or HRR percentage. To set the heart rate interval calculation method, open the Huawei Health

app, go to **Me > Settings > Heart rate limit and zones** and set **Calculation method** to either **Maximum heart rate percentage** or **HRR percentage**.

- If you select **Maximum heart rate percentage** as the calculation method, the heart rate zone for different types of workout activities (Extreme, Anaerobic, Aerobic, Fat-burning, and Warm-up) is calculated based on your maximum heart rate ("220 – your age" by default). Heart rate = Maximum heart rate x Maximum heart rate percentage.
- If you select HRR percentage as the calculation method, the heart rate interval for different types of workout activities (Advanced anaerobic, Basic anaerobic, Lactic acid, Advanced aerobic, and Basic aerobic) is calculated based on your heart rate reserve (HRmax - HRrest). Heart rate = Heart rate reserve x Heart rate reserve percentage + Resting heart rate.
- The heart rate zone calculation methods while you are running are not affected by the settings in the Huawei Health app. For most running courses, **HRR percentage** is selected by default.

Your watch will display different colors when your heart rate reaches corresponding zones during a workout. The following figure shows how heart rate is displayed during an outdoor run.



- Measuring your heart rate during a workout
 - 1 After you start a workout, swipe on the watch screen to check your real-time heart rate and heart rate zone.
 - 2 After completing your workout, you can check your average heart rate, maximum heart rate, and heart rate zone on the workout results screen.
 - 3 You can view graphs that show the changes in heart rate, maximum heart rate, and average heart rate for each workout under **Exercise records** in the Huawei Health app.

-  Your heart rate will not be displayed if you remove the watch from your wrist during the workout. However, the watch will continue to search for your heart rate for a while. The measurement will resume once you wear the watch again.
- Your watch can measure your heart rate when you have connected it to your phone and started a workout using the Huawei Health app.
- Heart rate monitoring during swimming is supported on the HUAWEI WATCH GT 2 and HUAWEI WATCH GT 2e.

Continuous heart rate monitoring

To enable this feature, connect your watch to your phone using the Huawei Health app and enable **Continuous heart rate monitoring** in the Huawei Health app. Once this feature is enabled, your watch can measure your real-time heart rate.

Set the **MONITORING MODE** to **Smart** or **Real-time**.

- Smart mode
 - 1 The heart rate measurement will be performed every 10 minutes for low-intensity activities (such as when you are not moving).
 - 2 The heart rate measurement will be performed every 10 minutes for moderate-intensity activities (such as when you are walking).
 - 3 The heart rate measurement will be performed once a second for high-intensity activities (such as when you are running) and it takes 6 to 10 seconds to display the first heart rate value, though this may vary between individuals).
- Real-time mode: The heart rate measurement will be performed once a second for any type of activity intensity.

When this feature is enabled, the watch will continuously measure your real-time heart rate. You can view graphs for your heart rate in the Huawei Health app.

-  Using Real-time mode will increase the power consumption of your watch while Smart mode will adjust the heart rate measurement interval based on the intensity of your activity, thus reducing power consumption.

Resting heart rate measurement

Resting heart rate refers to the heart rate when it is measured in a quiet and relaxed environment when you are awake. It is a general indicator of cardiovascular health.

The best time to measure your resting heart rate is immediately after you have woken up in the morning. Your actual resting heart rate may not be displayed or accurately measured if your heart rate was measured at the wrong time.

To automatically measure your heart rate, enable **Continuous heart rate monitoring** in the Huawei Health app.

If "--" is displayed as the resting heart rate reading, it indicates that your watch was unable to measure your resting heart rate. In this case, ensure that you measure your resting heart rate in a quiet and relaxed environment when you are awake. It is recommended that you

measure your resting heart rate immediately after you wake up in the morning for the most accurate result.

- If you disable **Continuous heart rate monitoring** after checking your resting heart rate, the resting heart rate displayed in the Huawei Health app will remain the same.

Heart rate warning

After you start a workout using your watch, your watch will vibrate to alert you that your heart rate value has exceeded the upper limit for more than 10 seconds. To view and configure your heart rate limit, perform the following:

Open the Huawei Health app, go to **Me > Settings > Heart rate limit and zones** and select your desired heart rate limit. The following figure shows how to set your heart rate limit:

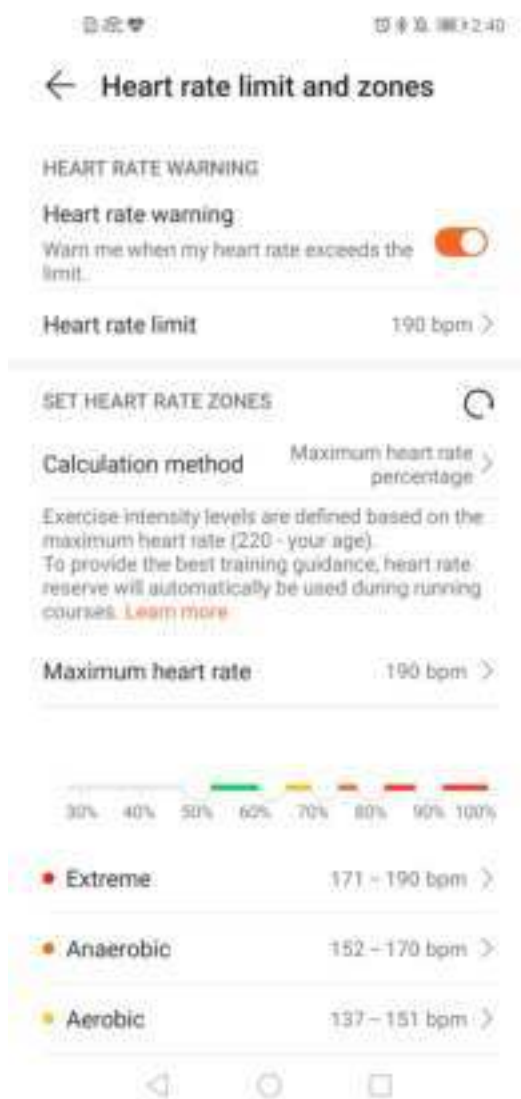

- The default heart rate limit is $220 - \text{age}$, which is obtained from the personal information you enter.
- If you disable voice guidance for individual workouts, you will only be alerted through vibrations and card prompts.
- Heart rate alerts are only available during active workouts and are not generated during daily monitoring.

To enable **High heart rate alerts** for your resting heart rate, open the Huawei Health app, touch **Devices** then your device, go to **Continuous heart rate monitoring > High heart rate alert**, and set your heart rate upper limit. Then, touch **OK**. When you are not doing any exercise, you will receive an alert when your resting heart rate stays above your set limit for more than 10 minutes.

Tracking sleep

Your watch collects sleep data and identifies your sleep status when you wear it while sleeping. It can automatically detect when you fall asleep and wake up and whether you are in a light or deep sleep. You can sync and view your sleep data in detail in the Huawei Health app.

Your watch measures your sleep data from 20:00 to 20:00 on the following day (24 hours in total). For example, if you sleep for 11 hours from 19:00 to 06:00, your watch will count the length of time you slept before 20:00 during the first day as well as the rest of the time that you were asleep during the second day.

From the home screen press the Up button, swipe until you find **Sleep**, then touch it and swipe up on the screen to view your nighttime sleep duration and nap duration. Your daytime sleep duration is displayed under **Naps**.

You are able to view your history sleep data in the Huawei Health app. Open the Huawei Health app and touch Sleep to view your daily, weekly, monthly, and yearly sleep statistics.

 **Naps** that you take during the day are counted under **Naps**. If you take a midday nap of less than 30 minutes or you moved around too much during a midday nap, your watch may have determined incorrectly that you were awake.

You can enable **HUAWEI TruSleep™** in the Huawei Health app.

After you enable **HUAWEI TruSleep™**, your watch will collect your sleep data, detect when you fall asleep, wake up, and whether you are in a light, deep, or REM sleep, and identify the times when you wake up and your breathing quality to provide you with a sleep quality analysis and suggestions to help you understand and improve your sleep quality.

When your watch detects that you are sleeping, it will automatically disable Always-on screen, message reminders, incoming call notifications, Raise wrist to wake screen, and other features in order to not disturb your sleep.

Testing stress levels

You can use your watch to test your stress level on a one-off or periodic basis.

- To measure your stress level on a one-off basis: Open the Huawei Health app, touch **Stress** then **Stress test**. When using this feature for the first time, you need to calibrate the stress value. Follow the onscreen instructions in the Huawei Health app to answer the questionnaire for a better stress test result.

- To measure your stress level on a periodic basis: Open the Huawei Health app, touch **Devices**, then touch your device name, enable **Automatic stress test** and follow the onscreen instructions to calibrate the stress value. Make sure that you are wearing your watch correctly and the watch will periodically test your stress level.

Viewing stress data:

- Viewing stress data on the watch: Press the Up button while on the home screen, swipe up or down until you find **Stress**, and touch it to view the graph indicating your stress change, including the stress bar chart, your stress level, and your stress interval.
- Viewing stress data in the Huawei Health app: Open the Huawei Health app, touch **Stress** to view your latest stress level and your daily, weekly, monthly and yearly stress curve and corresponding advice. At the same time, you can refer to content under **STRESS RELIEF ASSISTANT** to reduce your stress and stay relaxed.

-  Stress tests are only available with a HUAWEI WATCH GT 2/HUAWEI WATCH GT 2e and require an Android phone.
 - During the stress test, wear your watch correctly and keep still.
 - Your watch will be unable to accurately detect your stress level during a workout or when you move your wrist too frequently. In this case, your watch will not carry out a stress test.
 - The accuracy of the data may be affected by caffeine, nicotine, alcohol, and some psychotropic medication. In addition, heart disease, asthma, exercise or an incorrect wearing position will also affect the data.
 - The watch is not a medical device and the data is for reference only.

Activity reminder

When **Activity reminder** is enabled, your band will monitor your activity to make sure you don't sit still for long periods of time (set to 1 hour by default). If it detects that you have been still for longer than the set period of time, the band will vibrate and the screen will light up to remind you to take a break and walk around.

Disable **Activity reminder** in the Huawei Health app if you find the reminders distracting.

-  Your band will not vibrate to remind you to move around if you have enabled **Do not disturb** for your band in the Huawei Health app.
 - Your band will not vibrate when it detects that you are asleep.
 - Your band will only send reminders from 8:00 to 12:00 and from 14:00 to 20:00.

Enabling HUAWEI TruSleep™

For Android users:

Open the Huawei Health app, touch **Devices**, then touch your device name, and enable **HUAWEI TruSleep™**.

For iOS users:

Open the Huawei Health app, touch **Devices**, then touch your device name, and enable **HUAWEI TruSleep™**.

-  Enabling **HUAWEI TruSleep™** may reduce the battery life.
- **HUAWEI TruSleep™** is disabled by default.
- The HUAWEI TruSleep™ tracking will not be affected if your phone powers off while you are asleep.
- Enabling **Do not disturb** in the Huawei Health app will not affect the HUAWEI TruSleep™ tracking.

Watch faces

Changing watch faces

Method 1: Touch and hold the home screen, and then swipe left or right to choose a watch face.

Method 2: From the home screen press the Up button, go to **Settings > Display > Watch face**, and then swipe left or right to choose a watch face.

Method 3: Open the Huawei Health app, touch **Watch faces** and then **Mine**, choose a watch face as needed, and then touch **Set as default**.

Setting Gallery watch faces

- Only available on Android phones. If you are using iOS, unpair the device, then pair it with an Android phone and follow the instructions to transfer photos. The photos will be saved and you can unpair the device and pair it with your iOS phone again
 - This feature requires that the Health app be updated to version 10.0.0.633 or above and the watch updated to 1.0.1.16 or above.
 - You may not be able to set Gallery Watch faces in certain countries and regions.
- 1 Open the Huawei Health app, touch **Devices**, go to **Watch faces > More > Mine**, and touch **Gallery**.
 - 2 Touch **+** and choose to either upload an image from your phone's Gallery or take a new photo. Then select your desired image and touch **Save**. Your watch will then display your customized image, as shown in the following figure:

← Gallery 



Set as default

Background Style Layout



← Gallery 



Set as default

Background Style Layout

Upload



CANCEL

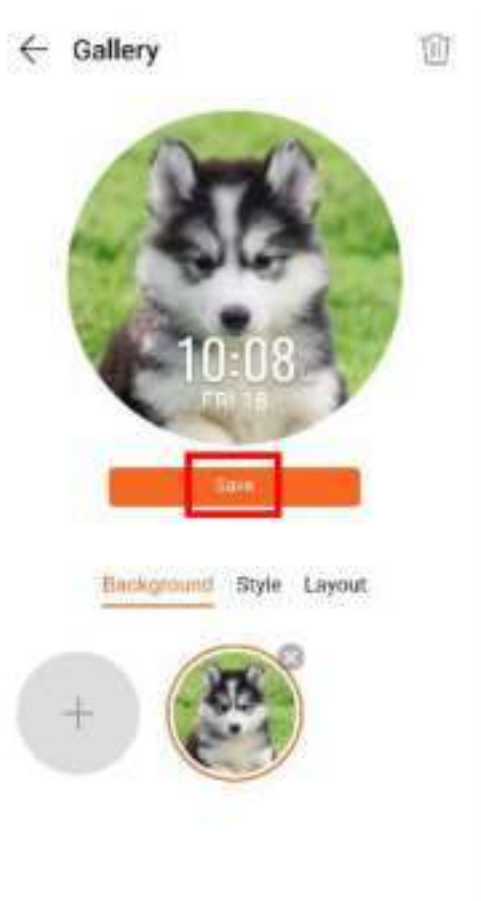

- 3 On the **Gallery** screen in the Huawei Health app, touch **Style** to customize the font and color of the displayed time and date.
- 4 Touch **Layout** to adjust the position of the displayed time and date.
 -  Only still images can be used as watch faces. There are no restrictions on the file format
 - A maximum of 5 images can be transferred at one. If you transfer multiple images an image will be selected randomly and displayed each time the screen wakes up. You can switch between the images by tapping the screen when it's on.

Installing, replacing, and deleting watch faces

Download and install even more cool watch faces by performing the following:

- 1 Open the Huawei Health app and touch your watch name. Go to **Watch faces > More** and see all the watch faces that are supported on your watch.
- 2 Select your desired watch face and touch **Install**. After the watch face is installed, your watch will automatically display the new watch face.
- 3 Choose an installed watch face, touch **SET AS DEFAULT**, and your watch will switch to the new one.

Deleting a watch face:

To delete a watch face, open the Huawei Health app, touch **Devices**, touch **Watch faces**,

touch **Mine**, select the watch face you want to delete, touch  in the upper-right corner,

and the watch face installed on your watch will then be deleted. Certain preinstalled watch faces cannot be deleted.

- You cannot download additional watch faces in the Huawei Health app on an iOS phone. To download new watch faces, you are advised to temporarily pair your watch with an Android phone. When the downloaded watch faces are synced to your watch, pair the watch back with your iOS phone.
- To download or delete watch faces, update your watch and the Huawei Health app to the latest versions.
- You may not be able to download or delete watch faces in certain countries and regions. For more information, contact the local Huawei hotline.

Setting a standby watch face

When your watch enters standby mode, the standby watch face will be displayed. The standby watch face is disabled by default. To enable this feature, perform the following:

- 1 From the home screen press the Up button, go to **Settings > Display > Advanced > Standby watch face**.
- 2 Touch **Style**, choose your preferred style, and then touch **OK**.
- 3 Touch **Color**, choose your preferred color, and then touch **OK**.
 - When the watch enters standby mode, touch the standby watch face to switch to the home screen.
 - To disable the standby watch face feature, touch **Style** and then choose **None**.
 - Enabling the standby watch face feature will drain the battery life by half and disable the Raise wrist to wake screen feature.
 - To enable the standby watch face feature, you are advised to update the HUAWEI WATCH GT Classic/Active/Sport to version 1.0.8.34 or later, the HUAWEI WATCH GT Elegant to version 1.0.60.28 or later, or the HONOR Dream/Magic/VIVIENNE TAM to version 1.0.9.4 or later.

Setting up dual time zones

Touch and hold the watch's home screen to switch designs. Some designs will have a settings icon beneath them. Touch the icon to enable dual time zone display.