

ASSEMBLY INSTRUCTION

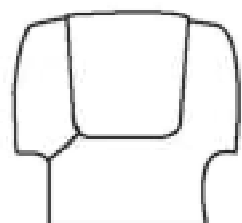

(1)*1

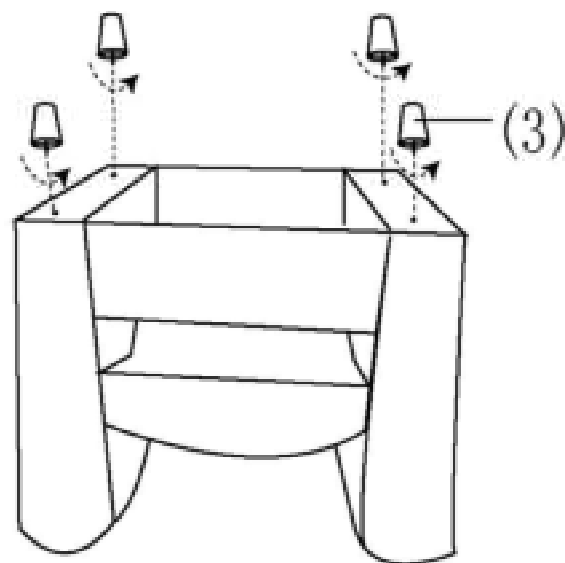

STEP1

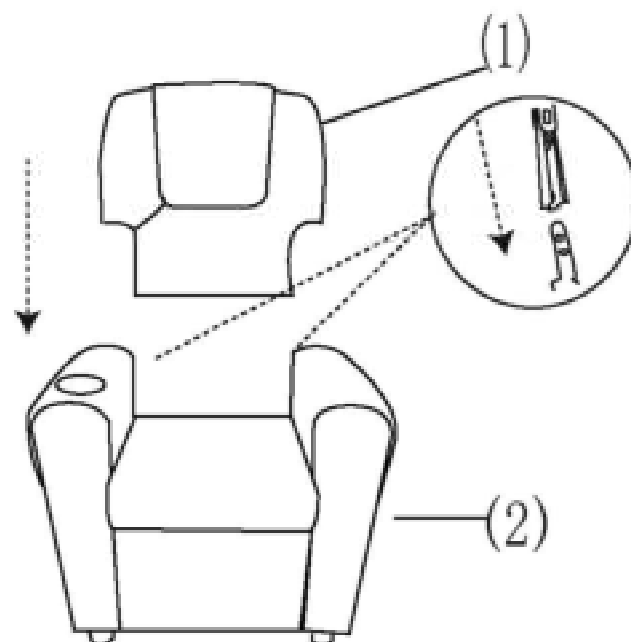

STEP2

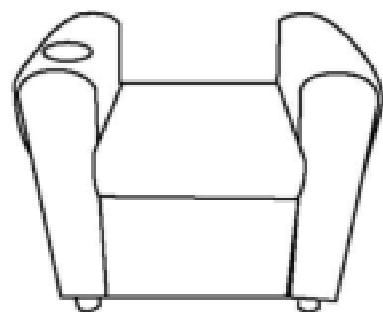

(2)*1

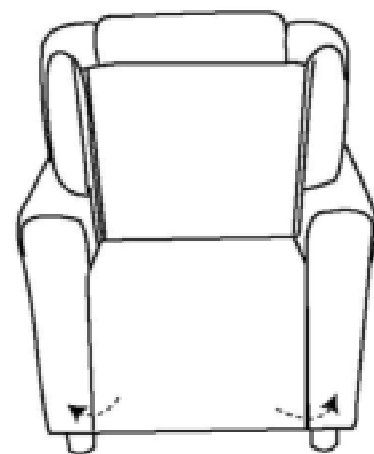

STEP3



(3)*4

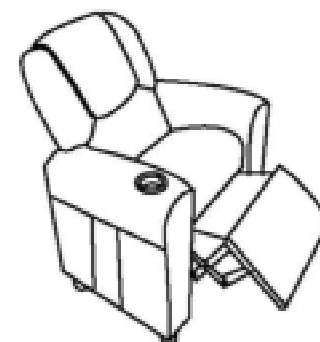
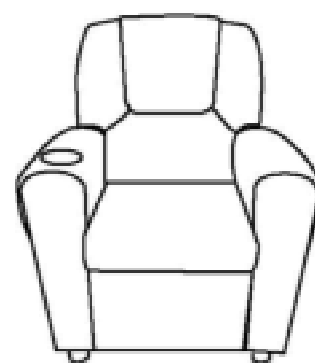

STEP4