• Safety Information 01
• FCC Statement 06
• Battery and Charging 08
• Welcome 09
• Product Introduction 10
• Installation 15
• Instructions for Use 19
• Routine Maintenance 23
• Basic Parameters 28
• Troubleshooting 29
• FAQs 31

IMPORTANT SAFETY INSTRUCTIONS

When using an electrical appliance, basic precautions should always be followed, including the following:

READ ALL INSTRUCTIONS BEFORE USING (THIS APPLIANCE), Failure to follow the warnings and instructions may result in electric shock, fire and/or serious injury.

WARNING

To reduce the risk of fire, electric shock, or injury:

- Do not use outdoors or on wet surfaces.
- Do not allow to be used as a toy. Close attention is necessary when used by or near children, pets or plants.
- Use only as described in this manual. Use only manufacturer's recommended attachments.
- Do not use with damaged cord or plug. If appliance is not working as it should, has been dropped, damaged, left outdoors, or dropped into water, return it to a service center.
- Do not pull or carry by cord, use cord as a handle, close a door on cord, or pull cord around sharp edges or corners.
- Do not run appliance over cord. Keep cord away from heated surfaces.
- Do not unplug by pulling on cord. To unplug, grasp the plug, not the cord.
- Do not handle charger, including charger plug, and charger terminals with wet hands.
- Do not put any object into openings. Do not use with any opening blocked; keep free of dust, lint, hair, and anything that may reduce air flow.
- Keep hair, loose clothing, fingers, and all parts of body away from openings and moving parts.
- Do not use to pick up flammable or combustible liquids, such as gasoline, or use in areas where they may be present.
- Do not pick up anything that is burning or smoking, such as cigarettes, matches, or hot ashes.
- Do not use without dust bag.
- Prevent unintentional starting. Ensure the switch is in the off-position before connecting to battery pack, picking up or carrying the appliance. Carrying the appliance with your finger on the switch or energizing appliance that have the switch on invites accidents.

- For use only with roborock CDZ08RR or CDZ09RR charger. Recharge only with the charger specified by the manufacturer. A charger that is suitable for one type of battery pack may create a risk of fire when used with another battery pack.
- Use appliances only with specifically designated battery packs. Use of any other battery packs may create a risk of injury and fire.
- Disconnect the battery pack from the appliance before making any adjustments, changing accessories, or storing appliance. Such preventive safety measures reduce the risk of starting the appliance accidentally.
- When battery pack is not in use, keep it away from other metal objects, like paper clips, coins, keys, nails, screws or other small metal objects, that can make a connection from one terminal to another. Shorting the battery terminals together may cause burns or a fire.
- Under abusive conditions, liquid may be ejected from the battery; avoid contact. If contact accidentally occurs, flush with water. If liquid contacts eyes, additionally seek medical help. Liquid ejected from the battery may cause irritation or burns.
- Do not use a battery pack or appliance that is damaged or modified. Damaged or modified batteries may exhibit unpredictable behavior resulting in fire, explosion or risk of injury.
- Do not expose a battery pack or appliance to fire or excessive temperature. Exposure to fire or temperature above 130°C may cause explosion.
- Follow all charging instructions and do not charge the battery pack or appliance outside of the temperature range specified in the instructions. Charging improperly or at temperatures outside of the specified range may damage the battery and increase the risk of fire.
- Have servicing performed by a qualified repair person using only identical replacement parts. This will ensure that the safety of the product is maintained.
- Do not modify or attempt to repair the appliance or the battery pack except as indicated in the instructions for use and care.
- Place the cords from other appliances out of the area to be cleaned.
- Do not operate the vacuum in a room where an infant or child is sleeping.
- Do not operate the vacuum in an area where there are lit candles or fragile objects on the floor to be cleaned.
- Do not operate the vacuum in a room that has lit candles on furniture that the vacuum may accidentally hit or bump into.

- Do not allow children to sit on the vacuum.
- Do not use the vacuum cleaner on a wet surface.
Risk Of Injury. Brush May Start Unexpectedly. Disconnect the main Brush Before Cleaning or Servicing.
- Do not use the product when the temperature is higher than 40C or lower than 4C, or there is any liquid or sticky substance on the floor.

SAVE THESE INSTRUCTIONS

Household use only.

IMPORTANTES MESURES DE S CURIT

L'utilisation d'un appareil électrique demande certaines précautions:

LIRE TOUTES LES INSTRUCTIONS AVANT DE FAIRE FONCTIONNER (CETAPPAREIL), Le non-respect des mises en garde et des instructions peut causer des chocs électriques, des incendies et/ou des blessures graves.

AVERTISSEMENT

- Pour réduire les risques d'incendie, de choc électrique ou de blessure:
- Ne pas exposer à la pluie, Ranger à l'intérieur.
- Ne pas permettre aux enfants de jouer avec l'appareil. Une attention particulière est nécessaire lorsque l'appareil est utilisé par des enfants ou à proximité de ces derniers.
- N'utiliser que conformément à cette notice avec les accessoires recommandés par le fabricant.
- Ne pas utiliser si le cordon ou la fiche est endommagé. Retourner l'appareil à un atelier de réparation s'il ne fonctionne pas bien, s'il est tombé ou s'il a été endommagé, oublié à l'extérieur ou immergé.
- Ne pas tirer soulever ni trainer l'appareil par le cordon. Ne pas utiliser le cordon comme une poignée, le coincer dans l'embrasure d'une porte ou l'appuyer contre des arêtes vives ou des coins. Ne pas faire rouler l'appareil sur le cordon. Garder le cordon à l'écart des surfaces chaudes. Ne pas débrancher en tyrant sur le cordon. Tirer plutt la fiche.
- Ne pas manipuler le chargeur, y compris la prise du chargeur, et les bornes du chargeur avec les mains mouillées.

- N'insérer aucun objet dans les ouvertures. Ne pas utiliser l'appareil lorsqu'une ouverture est bloquée. S'assurer que de la poussière, de la peluche, des cheveux ou d'autres matières ne réduisent pas le débit d'air. Maintenir les cheveux, les vêtements amples, les doigts et toutes les parties du corps à l'écart des ouvertures et des pièces mobiles.
- User de prudence lors du nettoyage des escaliers.
- Ne pas aspirer des liquides inflammables ou combustibles, comme de l'essence, et ne pas faire fonctionner dans des endroits où peuvent se trouver de tels liquides.
- Ne pas aspirer de matières en combustion ou qui dégagent de la fumée, comme des cigarettes, des allumettes ou des cendres chaudes.
- Ne pas utiliser l'appareil si le sac à poussière ou le filtre n'est pas en place.
- Empêcher une mise en marche accidentelle. S'assurer que l'interrupteur est à la position arrêt avant de raccorder la batterie, de lever ou de déplacer l'appareil. Transporter l'appareil en gardant un doigt sur l'interrupteur, ou mettre sous tension un appareil dont l'interrupteur est à la position marche peut causer un accident.
- Pour emploi seulement avec roborock CDZ08RR or CDZ09RR chargeur. Recharger uniquement avec le chargeur prescrit par le fabricant. Un chargeur convenant à un type de batterie peut présenter un risque d'incendie lorsqu'il est utilisé avec une autre batterie.
- Retirer la batterie de l'appareil avant d'effectuer des réglages, changer les accessoires ou ranger l'appareil. Ces mesures de sécurité ont pour but d'éviter une mise en marche accidentelle de l'appareil.
- Lorsque l'appareil n'est pas utilisé, tenir la batterie loin d'objets métalliques comme des trombones, des pièces de monnaie, des clés, des clous, des vis ou autres petits objets qui pourraient établir une liaison entre les bornes. Un court-circuit des bornes des batteries peut causer des brûlures ou un incendie.
- Utiliser uniquement les batteries recommandées pour l'appareil. L'utilisation d'autres types de batteries peut présenter un risque de blessure ou d'incendie.
- Lorsque l'appareil n'est pas utilisé, tenir la batterie loin d'objets métalliques comme des trombones, des pièces de monnaie, des clés, des clous, des vis ou autres petits objets qui pourraient établir une liaison entre les bornes. Un court-circuit des bornes des batteries peut causer des brûlures ou un incendie.
- En condition d'usage abusif, du liquide peut s'échapper de la batterie ; éviter tout contact avec ce liquide.
- En cas de contact accidentel, rincer abondamment avec de l'eau. En cas de contact avec les yeux, consulter également un médecin. Le liquide projeté peut causer des irritations ou des brûlures.

- Ne pas utiliser une batterie ou un appareil endommagé ou qui a été modifié. Des batteries endommagées ou modifiées peuvent avoir un comportement imprévisible pouvant causer un incendie, une explosion ou un risque de blessure.
- Ne pas exposer une batterie ou un appareil à la flamme ou à des températures excessives. L'exposition à une flamme ou à des températures supérieures à 130 °C peut causer une explosion.
- Respecter toutes les instructions de chargement et ne pas charger la batterie ou l'appareil à des températures qui ne sont pas incluses dans la gamme de températures indiquées dans la notice d'instructions. Un chargement mal effectué.
- Confier les réparations à une personne qualifiée qui utilisera uniquement des pièces de remplacement identiques. Cette façon de faire garantira la sécurité du produit.
- Ne pas modifier ni tenter de réparer l'appareil ou la batterie sauf comme il est indiqué dans les instructions d'utilisation et d'entretien.
- Éloigner les cordons d'autres appareils de la zone à nettoyer.
- Ne pas utiliser l'aspirateur dans une pièce où un nourrisson ou un enfant dort.
- Ne pas utiliser l'aspirateur dans un endroit où il ya des bougies allumées ou des objets fragiles sur le plancher à nettoyer.
- Ne pas utiliser l'aspirateur dans une pièce où il ya des bougies allumées sur les meubles que l'aspirateur peut heurter ou se cogner accidentellement.
- Ne pas laisser les enfants s'asseoir sur l'aspirateur.
- Ne pas utiliser l'aspirateur sur une surface mouillée.
Risque de blessures. La brosse motorisée peut se mettre en marche d'une manière imprévue.
- Déconnecter la brosse principale avant le nettoyage ou le service.

CONSERVER CES INSTRUCTIONS

Usage Domestique seulement.

Laser Safety

Class I Laser Product, complies with FDA 21 CFR 1040.10 and 1040.11, except for deviations pursuant to Laser Notice No.50, dated June 24, 2007.

Compliance Information	
Product Name	Robotic Vacuum Cleaner with Dock Charger
Produce Model	Robotic Vacuum Cleaner Model: roborock S6 Dock Charger Model: CDZ08RR, CDZ09RR
Compliance Statement	This device complies with part 15 of the FCC Rules. Operation is subject to the following two conditions: (1) This device may not cause harmful interference, and (2) this device must accept any interference received, including interference that may cause undesired operation.
Correspondence of the responsible party in USA	
Company	Roborock Technology Co.,Ltd.
Address	108 West 13th Street, Wilmington, Delaware 19801.
Email	support@roborock.com

Warning

Any changes or modifications to this unit not expressly approved by the party responsible for compliance could void the user's authority to operate the equipment.

Le présent appareil est conforme aux CNR d'Industrie Canada applicables aux appareils radio exempts de licence.

L'exploitation est autorisée aux deux conditions suivantes :

(1) l'appareil ne doit pas produire de brouillage, et

(2) l'utilisateur de l'appareil doit accepter tout brouillage radioélectrique subi, même si le brouillage est susceptible d'en compromettre le fonctionnement.

Changes or modifications not expressly approved by the party responsible for compliance could void the user's authority to operate the equipment.

This equipment has been tested and found to comply with the limits for a Class B digital device, pursuant to part 15 of the FCC Rules. These limits are designed to provide reasonable protection against harmful interference in a residential installation. This equipment generates uses and can radiate radio frequency energy and, if not installed and used in accordance with the instructions, may cause harmful interference to radio communications. However, there is no guarantee that interference will not occur in a particular installation. If this equipment does cause harmful interference to radio or television reception, which can be determined by turning the equipment off and on, the user is encouraged to try to correct the interference by one or more of the following measures:

- Reorient or relocate the receiving antenna.
- Increase the separation between the equipment and receiver.
- Connect the equipment into an outlet on a circuit different from that to which the receiver is connected.
- Consult the dealer or an experienced radio/TV technician for help.

MPE Requirements

To satisfy FCC / IC RF exposure requirements, a separation distance of 20 cm or more should be maintained between the antenna of this device and persons during device operation. To ensure compliance, operations at closer than this distance is not recommended.

L'antenne installée doit être située de façon à ce que la population ne puisse être exposée à une distance de moins de 20 cm. Installer l'antenne de façon à ce que le personnel ne puisse approcher à 20 cm ou moins de la position centrale de l'antenne. La FCC des États-Unis stipule que cet appareil doit être en tout temps éloigné d'au moins 20 cm des personnes pendant son fonctionnement.

CAN ICES-3 (B)/NMB-3(B)

- Please keep the dock charger away from heat (such as heating plates).
- The battery must be removed from the appliance before it is scrapped.
- The appliance must be disconnected from the supply mains when removing the battery.
- The battery is to be disposed of safely. Please do not discard waste batteries. Leave them to a professional recycling organization.
- Do not wipe or clean the chargers shrapnel with a piece of wet cloth or wet hands.
- Please make sure the cleaner is powered off in shipment and original packaging is advised.
- If left unused for a long period, please store the cleaner in a cool and dry place after having it fully charged and switched off, charge it at least every three months to avoid the battery being over discharged.
- Please do not use the product when the temperature is higher than 40°C or lower than 4°C , or there is any liquid or sticky substance on the floor.

Battery pack charging temperature		4°C ~ 40°C	@Max Charging Current:0.5C
Battery pack using temperature		4°C ~ 40°C	@Max Discharge Current:0.5C
Battery pack storage temperature	Storage(1month)	-20°C ~ 60°C @Less than 70% RH	If the battery pack store at 25°C over the 3 months period, it should be recharged.
	Long Storage(3months)	-20°C ~ 45°C @Less than 70% RH	
	Long Storage(1year)	-20°C ~ 20°C @Less than 70% RH	

Thank you for choosing a Roborock S6 Robotic Vacuum Cleaner.

This product is a sweeping and mopping robot equipped with a high-precision laser guided navigation system that allows it to quickly and accurately create and store a map of every room of your home. Using this map, an advanced dynamic route planning system plans out the most efficient path for cleaning each of your rooms as quickly as possible. You can check this map, as well as the location of the product, and the progress of any clean, using the Mi Home app, which also lets you schedule cleans and take control remotely. If for any reason you can't use your phone, you can also control it using a variety of voice commands.

Through powerful sweeping and mopping systems inspired by nature, your floors are treated to a thorough clean and deep dirt removal every time you clean. After a clean, it automatically drives back to the charging dock to recharge, without out any help from you. Best of all, new noise reduction designs give you all the power with less of the noise so you can any time in the day or night without disruption.

Roborock is dedicated to putting the most advanced technologies to work making your life easier. With your new Roborock S6 product doing the hard work, you can focus on doing the things you truly enjoy.

Roborock

Main Unit

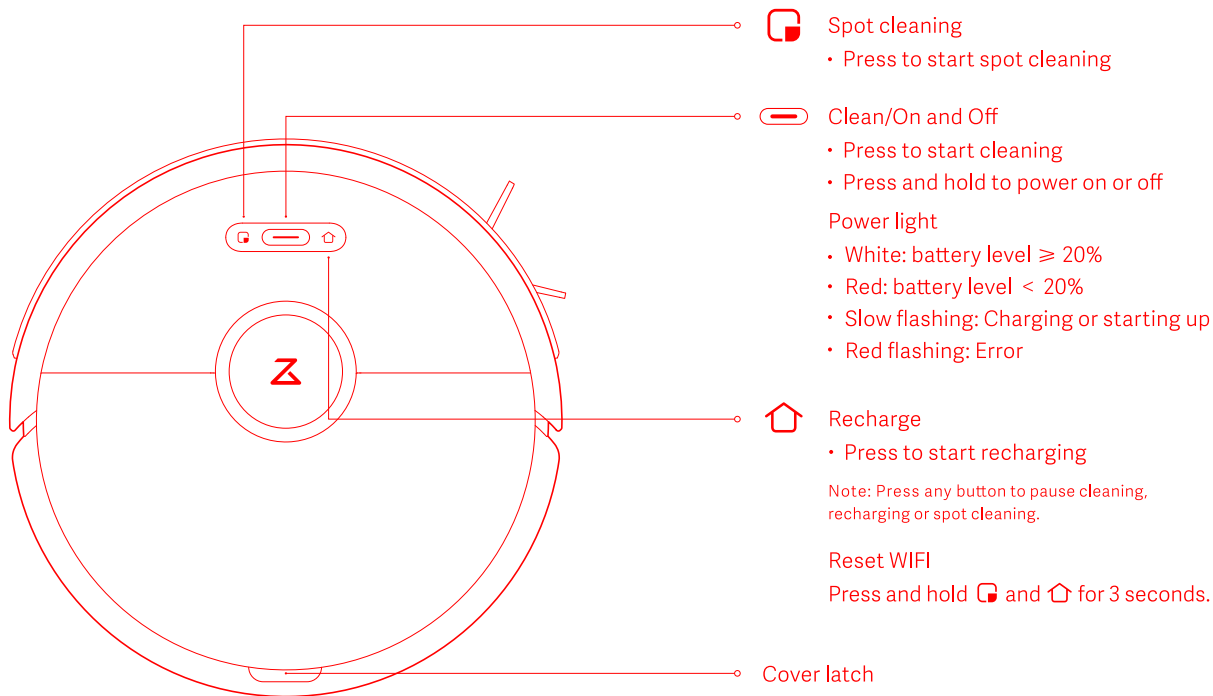

Part list



Adjustable water tank



Mop cloth

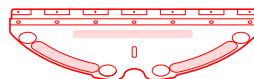

Mounting plate –
disposable mop cloth



Disposable mop cloth



Air filter

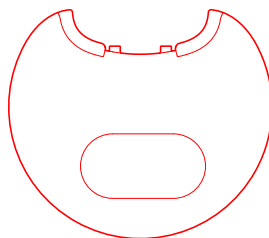

Damp-proof mat



Water filter

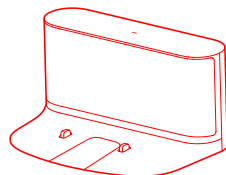

Charging dock

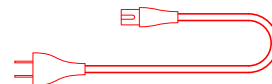

Power cable

Dustbin

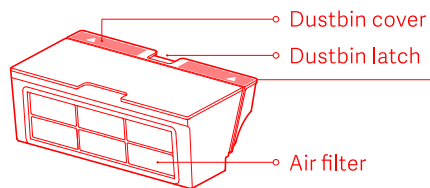

Main Unit

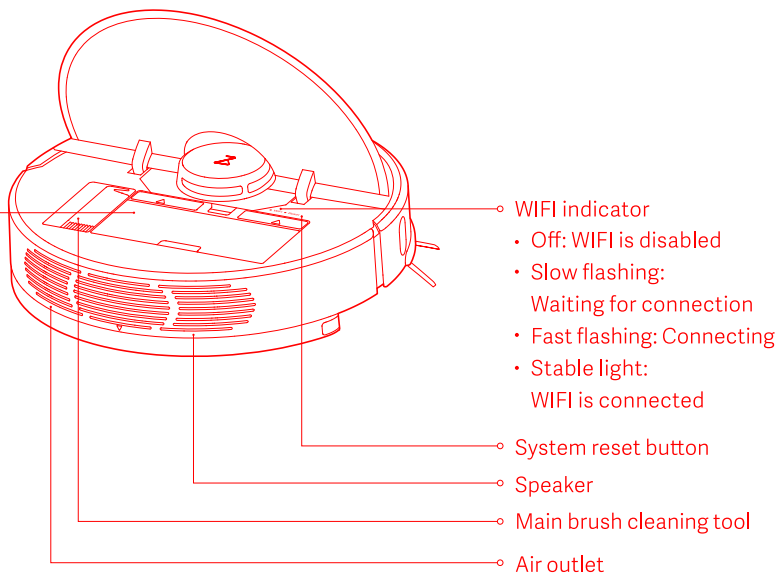

Main Unit and sensor

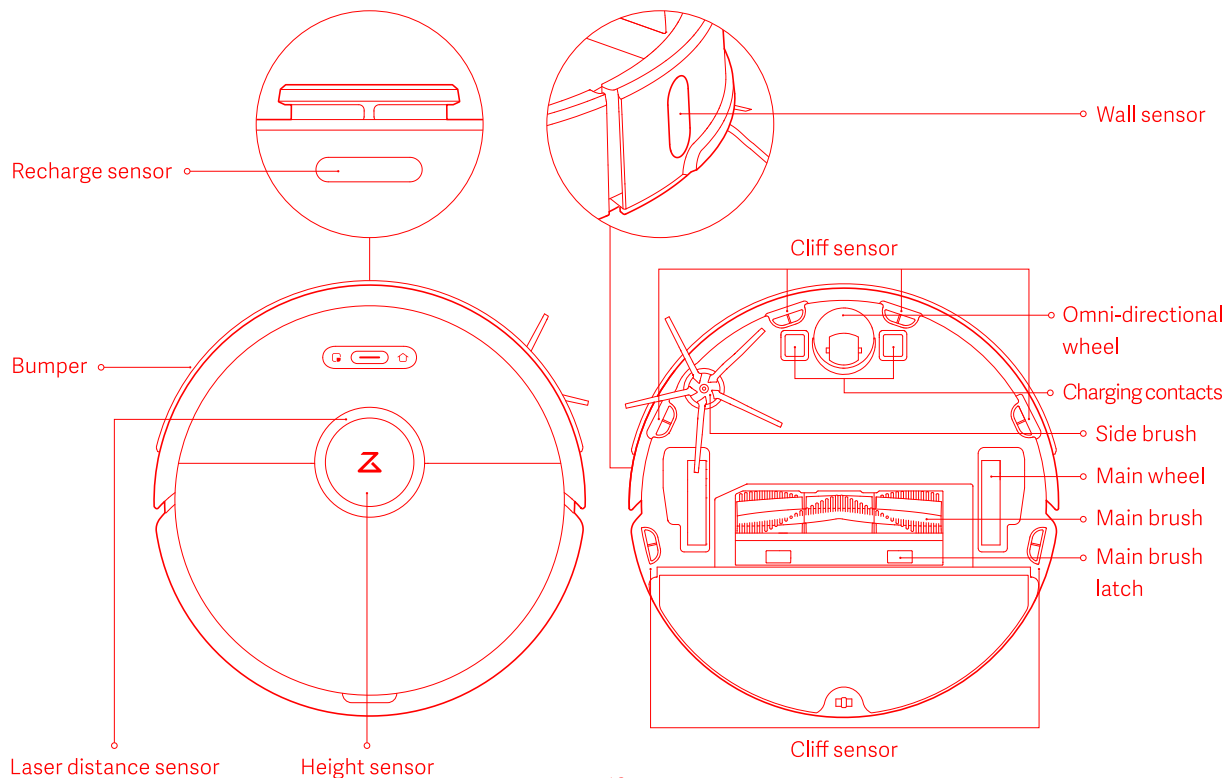

Mopping module

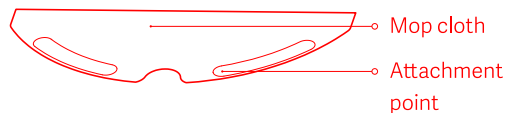
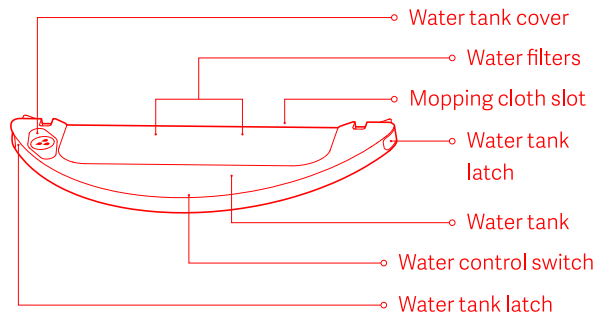

Charging Dock

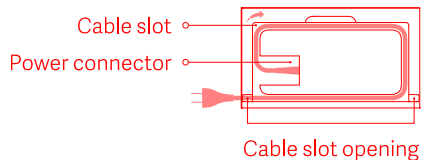
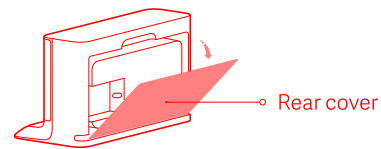
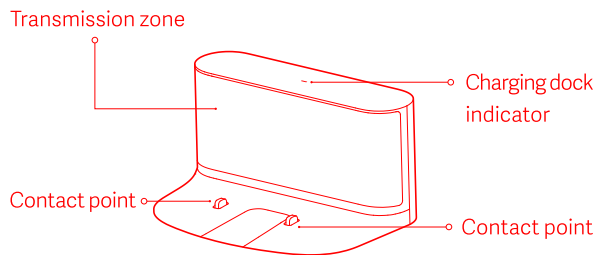

Setup

1. Clip the damp-proof mat onto the charging dock using the guiding grooves.

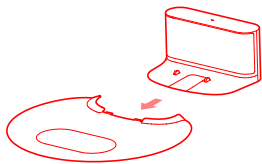

2. Place the charging dock against a wall on a level floor and plug it in. Hide any excess cable in the cable slot.

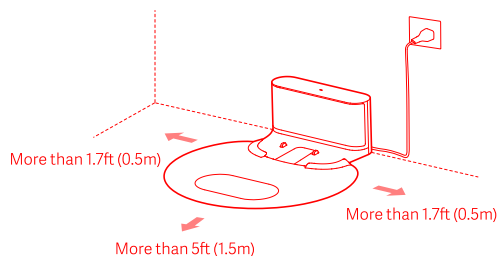

Notes:

- Keep at least 1.7ft (0.5m) on either side and 5ft (1.5m) in front of the charging dock clear.
- If the power cable is left hanging vertically, it may get caught as the main unit cleans, causing it to loosen or unplug.
- The charging dock indicator will be lit when the dock is plugged in, and off when the main unit is charging.

3. Power on and charge.

Press and hold the  button to power on, wait until the ring light turns on, and then place the main unit onto the charging dock to charge. The high-performance lithium-ion rechargeable battery pack inside must be charged regularly to maintain optimum battery performance.

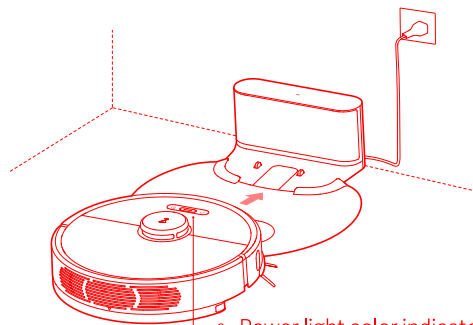

Power light color indicates battery level

- White: Battery level \geq 20%
- Red: Battery level $<$ 20%

Note: The product will not power on if the battery is low. Place the main unit directly onto the charging dock to recharge.

4. Connect to the Mi Home app. (Optional)

This product is compatible with the Mi Home smarthome platform and can be controlled using the Mi Home app. It also supports the MIUI ecosystem and can be connected to other Mi Home smarthome products.

Quick Setup

① Download Mi Home app

In the app store/Google play, search "Mi Home" or scan the QR code below to download and install the Mi Home app.



Note: For specific connection instructions, visit the Roborock website and download guidelines for iOS and Android devices.

② Add Device

Open the "My Device" page of the Mi Home app, tap "+" on the upper right corner of the page to add a device. You can find this newly added device in the "My Device" list.

Note: Due to upgrades and updates made to the Mi Home app, actual operation may vary slightly from the above description. Refer to the guidelines in the Mi Home app in use. WIFI connection only supports networks in the 2.4 GHz band, not the 5 GHz band.

③ Reset WIFI

If you experience any WIFI problems, reset the WIFI to defaults. Open the top cover to expose the WIFI indicator then press and hold the  button and the  button until you hear the "Reset WIFI" voice prompt. Reset is complete when the WIFI indicator flashes slowly. The product will then wait for a connection.

Note: If a mobile phone has never been connected to the product, or if there is a problem with the connection, reset the WIFI before attempting connection.

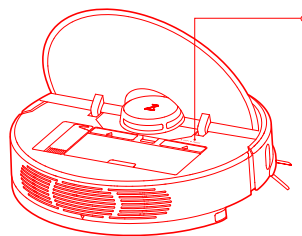

- WIFI indicator
- Off: WIFI is disabled
- Slow flashing: Waiting for connection
- Fast flashing: Connecting
- Stable light: WIFI is connected

Using the mop

5. Install the mopping module.

① Adjusting the water flow rate

Adjust the water flow rate according to your preferences.

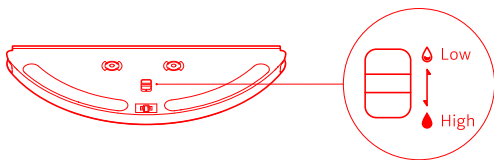

② Install the mop cloth

a. Installing a reusable mopping cloth

Dampen the mop cloth and squeeze it dry. Slot it into the mounting point and slide it along the groove on the water tank then press it firmly in place.

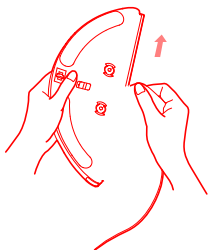

Note: Use barrier tapes to create a border around carpets.

b. Installing a disposable mop cloth

b1. Installing the disposable mop cloth plate

Insert the disposable mop cloth plate from right to left along the slot on the water tank as shown then press it firmly in place.

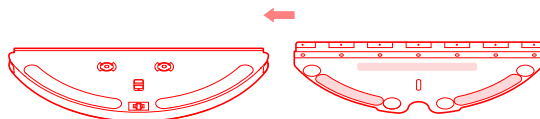

Disposable mop cloth plate

b2. Securing a disposable mop cloth

Place the water tank on a flat surface with the disposable mopping cloth fabric facing up. Align the cloth with the mop cloth plate and press it down firmly. Press down on the various locking points to secure the cloth onto the mop cloth plate.

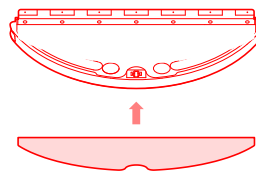

Disposable mop cloth

Using the mop

③ Refill the water tank

Open the water tank, fill the tank with water, then reseal it carefully.

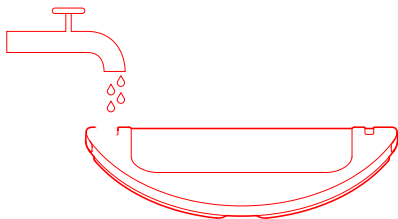

Note: Some floor cleaners or disinfectants may block the water filters.

④ Install the mopping module

Line the mopping module up with the alignment indicators on the rear of the Main Unit then slot it in until you hear a click.

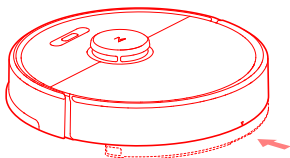

6. Start cleaning

When the power light changes from a slow white flash to a steady light, charging is complete. Press the  button or use the Mi Home app to start cleaning.

7. Remove the mopping module

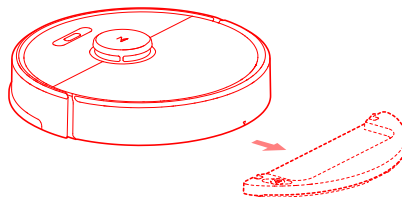

When a cleaning cycle is complete and the main unit has returned to the charging dock, press the latches on either side of the mopping module and pull backwards to remove it.



Notes:

- Remove the mopping module if the product is to be left unused. Empty any water left in the water tank and clean the mopping cloth to prevent mildew or odors.
- If the charging dock is placed on a wood floor, always use the damp-proof mat to avoid moisture leaking to the floor.

On / Off

Press and hold the  button to power on the main unit. The power light will turn on and the main unit will enter standby mode. When the main unit is idle, press and hold the  button to power off and end the current cleaning cycle.

Note: The main unit cannot be shut down during charging.

Start cleaning

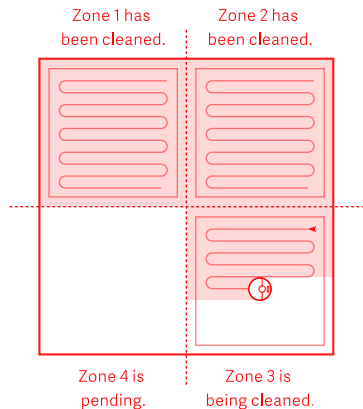

Press the  button to start cleaning. When cleaning, the product will plan an appropriate cleaning path based on the generated map of the scanned area. It will clean along the edges of a zone first and then plan a Z-shaped cleaning route to cover the whole zone efficiently and quickly without missing a spot.



Notes:

- Cleaning cannot be started if the battery level is too low. Recharge battery then restart cleaning.
- Tidy away cables (including the charging dock power cable) from the floor before cleaning to avoid power failure and to prevent damage resulting from a dragged cable.
- If a cleaning cycle is completed within 10 minutes, by default, cleaning will repeat.

Pause

When the product is running, press any button to pause it. Press the  button to restart cleaning or the  button to end the cleaning cycle and send the product back to the charging dock.

Note: Docking the main unit to the charging dock when paused will stop the current cleaning cycle.

Sleep

If inactive for more than 10 minutes, the product will enter sleep mode and its indicator light will flash slowly. Press any button to wake the product.

Notes:

- The product will not enter sleep mode when connected to the charging dock.
- The product will automatically shut down if left in sleep mode for over 12 hours.

Charge

Auto mode: After cleaning, the main unit will automatically return to the charging dock for charging.

Manual mode: In pause mode, press the  button to start recharging. The power light flashes slowly when the robot is being charged.

Note: If failing to find the dock charger, the main unit will automatically return to its starting point. Manually place the main unit onto the charging dock for charging.



Errors

If an error occurs, the power light will flash red quickly and a voice prompt will sound. Refer to “Troubleshooting” for solutions.

Notes:

- The product will automatically enter sleep mode after 10 minutes of inactivity in an error state.
- Docking the main unit to the charging dock in an error state will stop the current cleaning cycle.

Reset WIFI

If your smartphone cannot connect to the product for any reason, open the dustbin cover to view the WIFI indicator then press and hold the  button and the  button until you hear the “Reset WIFI” voice prompt. Reset is complete when the WIFI indicator flashes slowly.

Note: WIFI will be automatically disabled if it takes over an hour to connect. If you need to reconnect, reset the WIFI before proceeding.

Spot cleaning

In standby or pause mode, press the Spot Cleaning button to start spot cleaning. This mode cleans a 16.4ft (1.5m) square area centered on the product. After cleaning, it will return to its starting point.

Note: Starting spot cleaning in pause mode will stop the current cleaning cycle.

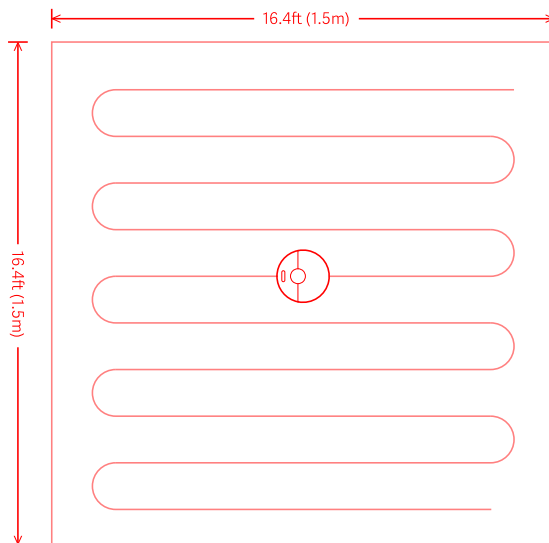

Room cleaning

Send the product to clean specific rooms of your home.

Note: Map saving must be switched on to use Room cleaning.

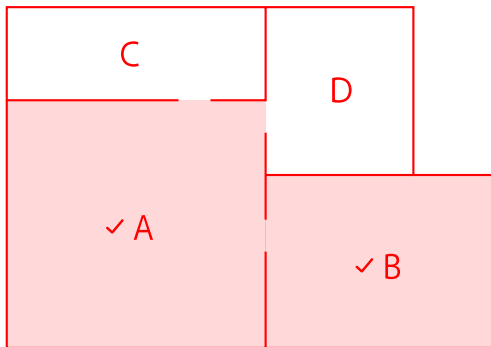

Scheduled cleaning

Schedule when you want the product to start cleaning. After cleaning, it will return to its charging dock.

Note: Scheduled cleaning requires the product to be connected to be internet and will not be carried out if the network connection is unstable or disconnected.

Zoned cleaning

Draw a cleaning zone and send the product to clean that specific area.

Clean the specified target area

Mark specific points on a map for cleaning and the product will navigate to them automatically.

Cleaning mode

Select Quiet, Balanced, Turbo or MAX mode. It is Balanced mode by default.

Do Not Disturb (DND) mode

Any active cleaning cycle will stop, voice messages will not play, and the ring light drops to low brightness. This mode is enabled by default from 22:00 - 08:00 and can be disabled or adjusted.

No-go Zones/Barrier tape

Set virtual no-go zones and barrier lines to prevent the product entering defied areas.

Notes:

- Map saving mode is required.
- This function should **only** be used to set cleaning areas, not to isolate hazardous areas.
- Moving the product or changing the home environment may result in a map failure or loss of the saved zones and barriers.

No-go Zones/Barrier tape

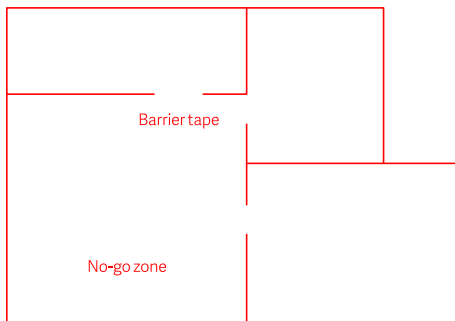

More app functions

Real-time map update	Carpet pressurization mode	Product location
Suction control	Cleaning duration	Mi Home smart devices
View cleaning logs	Remote control	Do Not Disturb mode
Voice selection	View status	Firmware updates

Note:

Functions and app details may change due to the continuous development and upgrading of the app. Refer to the app for details.

Refilling the water tank or cleaning the mop cloth mid-clean

If refilling the water tank or cleaning the mop cloth during a clean, press any button to pause the cleaning cycle and remove the mop module. Refill the water tank or clean the mopping cloth and reinstall the mopping module then press the  button to continue the cleaning cycle.

Charging dock

Place the charging dock on a level floor and keep at least 1.7ft (0.5m) on either side and at least 5ft (1.5m) in front of it and plug it in. For a better experience with the Mi Home app, place the charging dock in range of WIFI.

Note: Do not expose the charging dock to direct sunlight, Do not block the location signal area of the charging dock as this may prevent the product from returning to charge automatically.

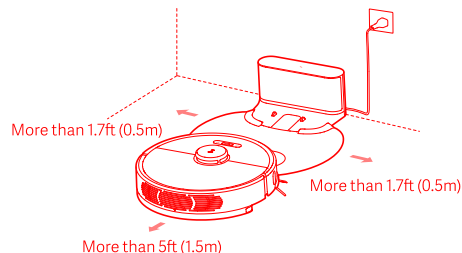

Main brush * Clean weekly

1. Flip the main unit over and push the latch to remove the main brush cover.
2. Lift the main brush out then remove and clean the bearing.
3. Rotate in the indicated unlock direction and remove the main brush cover.
4. Use the supplied brush cleaning tool to cut anything entangling the main brush or its bearing.
5. Re-install the main brush cover and the main brush bearing according to the lock direction.
6. Re-insert the the main brush and press the main brush cover back in until it is locked in place by the latch.

Note: Replacing the main brush every 6-12 months is recommended for maximum cleaning.

Using the main brush cleaning tool

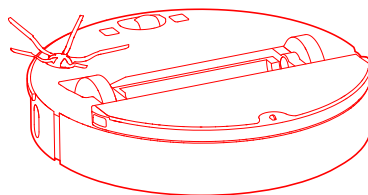
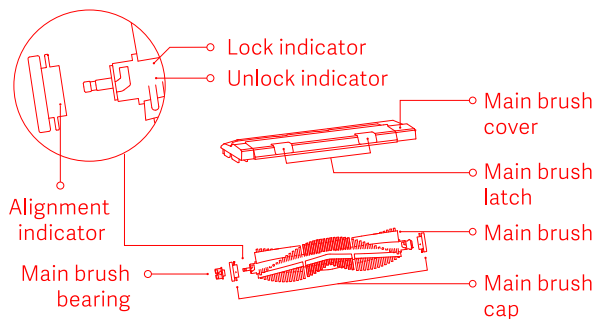
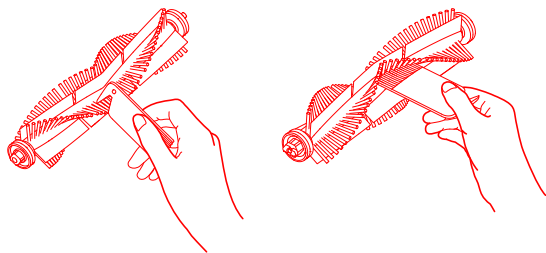

Dustbin and filter * Clean weekly

1. Open the top cover of the main unit and press the dustbin latch to release and remove the dustbin.

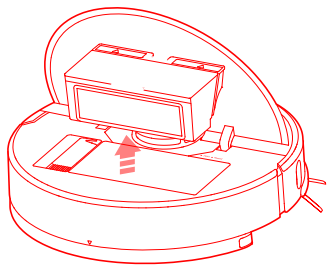

2. Open the dustbin cover as indicated by arrow and pour out the contents.

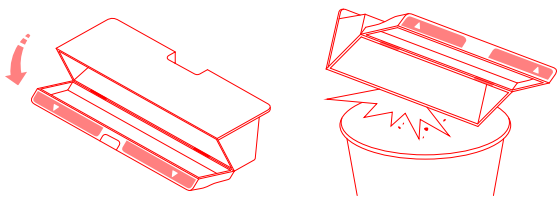

Clean the filter * Clean bi-weekly

1. Open the dust bin cover as indicated by the arrow.

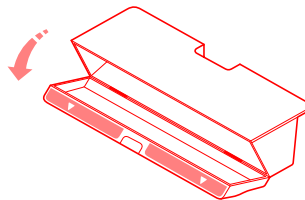

2. Fill the dustbin with clean water and close the cover. Shake the dustbin and pour out the dirty water.

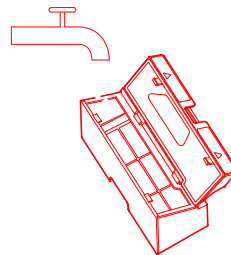

Note: Rinse with clean water without any detergent.

Clean the filter * Clean bi-weekly

3. Remove the filter and rinse with water.

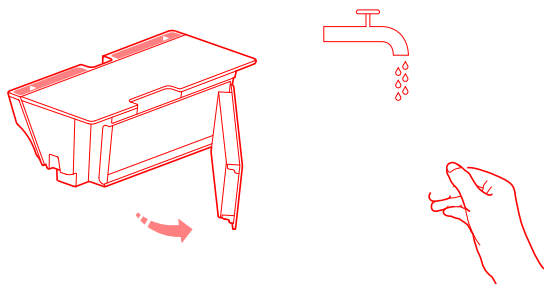

4. Rinse repeatedly and lightly tap the filter frame against a hard surface to shake loose any dirt. Continue until clean.



5. Dry the filter thoroughly and reinstall.

Notes:

- Always dry the filter for at least 24-hours before use.
- Alternating between two filters is recommended.

Battery

The product is equipped with a high-performance lithium-ion rechargeable battery. To maintain optimum battery performance, keep the main unit charged.

Note: If the main unit is to be left unused for a prolonged period of time, power it off before storage and charge it at least once every 3 months to avoid damaging the battery through over-discharging.

Charging dock * Clean monthly

Use a soft dry cloth to clean the charging contacts on the charging dock.

Side brush * Clean monthly

1. Flip the main unit over and remove the screws on the side brush unit.
2. Remove and clean the side brush.
3. Reinstall the side brush and tighten the screws.

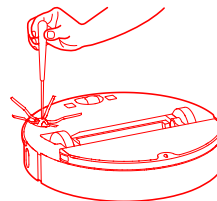

Note: Replacing the side brush every 3-6 months is recommended for maximum cleaning.

Ordinary mop cloth * Clean after use

1. Remove the mop cloth from the mopping module.

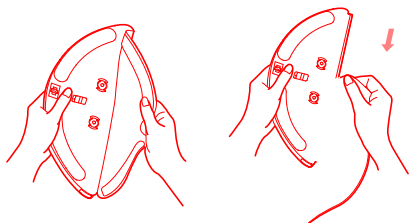

2. Clean the mopping cloth and dry it.

Notes:

- Always remove the mop cloth for cleaning to avoid dirty water that may block the filter flowing into the water tank.
- If the mop cloth is too dirty, mopping may be affected. Clean it before use.
- Changing the mop cloth every 3-6 months is recommended for maximum cleaning.

Disposable mopping cloth

Remove and discard used mop cloth, and replace it with a new one when required.

Note: Visit www.roborock.com to purchase additional disposable mop cloths.

Filter assembly * Replace every 1-3 months

1. Pull out the water filters as indicated.
2. Replace with new filters.



Note: Replacing filters every 1-3 months is recommended, depending on water quality and frequency of use, for maximum cleaning.

Omni-directional wheel * Clean monthly

1. Flip the main unit over and lift up the omni-directional wheel.
2. Remove any trapped hair and dirt on the wheel body and axle.
3. Reinstall the wheel body and press tightly in place.

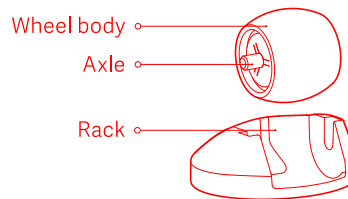



Note: The omni-directional wheel bracket cannot be removed.

Reset system

If buttons are unresponsive or the main unit cannot be shut down, reset the system by pressing the Reset button (refer to page 7). The main unit will restart after reset.

 Resetting the system will reset the scheduled cleaning modes, WIFI, and other related settings.

Restoring to factory defaults

If a problem persists after a system reset, power on the main unit then press and hold the  button. At the same time, press the Reset button. Keep holding the  button until you hear the "Start restoring initial version" voice prompt. The product will then restore all factory defaults.

Holiday Energy Saving Function

When the cleaner is on the charging dock, hold and press "Recharge" for 10 seconds until you hear a "Ding-dong" sound, and Holiday mode will be activated.

In this mode, the LED indicator will dim, functions that has nothing to do with charging such as cleaning, recharging and remote control via WIFI will be disabled, and the cleaner will enter low power consumption mode to maintain optimal battery performance.

After Holiday mode is activated, you can disable it by holding and pressing "Recharge" for 10 seconds until the LED indicator brightens.

Main unit sensors

Use a soft dry cloth to wipe and clean all sensors, including:

1. Six cliff sensors on the bottom.
2. One wall sensor on the right.
3. Charging contacts on the bottom.

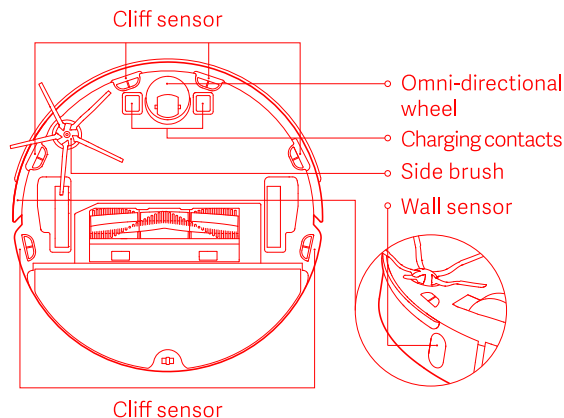

Firmware update

Use the Mi Home app to update the firmware. Connect the main unit to the charging dock and ensure that the battery charge is at more than 20% before updating.

Main Unit

Name	Specs
Model	roborock S6
Dimensions	353×350×96.5mm
Battery	14.4V/5200mAh lithium battery
Weight	About 3.6 kg
Wireless connection	WIFI direct connect
Voltage rating	14.4VDC
Power rating	58W

Charging Dock

Name	Specs
Model	CDZ08RR or CDZ09RR
Dimensions	160×232×116mm
Power rating	42W
Input rating	100-240VAC
Output rating	20VDC 1.8A
Frequency rating	50-60Hz

When a runtime error occurs, the power light flashes red quickly and a voice prompt is given. Please use the table below to solve the problem.

Fault display	Solution
Error 1: Turn the laser unit and check that it is not jammed or blocked.	The laser is stuck or has been blocked. Remove any blockages and retry. If the problem persists, move the main unit to a new location and restart it.
Error 2: Clean and lightly tap the bumper.	The bumper is stuck. Lightly tap the bumper to remove any blockages. If no blockages are found, move the main unit to a new location and restart it.
Error 3: Move the main unit to a new location and restart.	A wheel is not in contact with the ground. Move the main unit to a new location and restart it.
Error 4: Clean cliff sensors, move the main unit away from any drops, then restart.	The main unit is on standby. Move it to a new location and restart it. This problem may be caused by a dirty cliff sensor. Wipe sensor and retry.
Error 5: Remove and clean the main brush and brush bearing.	The main brush may have become tangled. Remove and clean it and its bearing.
Error 6: Remove and clean the side brush.	The side brush may have become entangled. Remove it for cleaning.
Error 7: Check that wheels are not blocked, then move the main unit to a new location and restart.	The main wheel may have become entangled. Remove it and restart the main unit.
Error 8: Remove any obstacles around the main unit.	The main unit may be stuck or caught on an obstacle. Clear any obstacles around it.
Error 9: Reinstall dustbin and filter.	Reinstall the dustbin and filter and check that they are installed correctly. If the problem persists, try replacing the filter.

Error 10: Check the filter. If wet, use a dry one. If dry, clean it and try again.	The filter is not completely dry. Dry it for at least 24 hours before use. The filter may be blocked. Clean it and restart. If the problem persists, replace the filter.
Error 11: Strong magnetic field detected. Move the device away from barrier tape and restart.	The main unit is too close to a barrier tape at startup. Move it and restart.
Error 12: Battery level too low. Recharge before use.	Low battery. Charge before use.
Error 13: Charging error. Cleaning charging contacts and try again.	Use a dry cloth to wipe main unit and charging dock charging contacts.
Error 14: Battery error.	The battery temperature is too high or too low. Wait until the battery temperature returns to normal before use.
Error 15: Clean wall sensor.	The wall sensor is blocked by dust. Wipe clean the sensor.
Error 16: Place and start the main unit on a level floor.	The main unit is starting on an incline. Place it on level ground and restart.
Error 17: Side brush module error. Reset the main unit.	A malfunction has occurred with the side brush module. Reset the system and try again.
Error 18: Fan error. Reset the main unit.	A malfunction has occurred with the vacuum cleaner fan. Reset the system and try again.
Error 21: Height sensor has been pressed. Move the main unit and restart.	The height sensor has been pressed or is stuck. Move the main unit to a new location and restart.
Error 22: Clean the recharge sensor on the main unit	The recharge sensor is blocked by dust. Wipe clean the sensor.
Error 23: Clean the transmission area on the charging dock.	The charging dock is obstructed. Clear the obstruction.
Internal error. Please try resetting the system.	Malfunction due to an internal error. Reset the system.

Note: Resetting the system may solve some problems.

If the problem persists after using the recommendations in the table above, please email our after-sales service team:

US/Non-Europe Support: support@roborock.com Europe Support: support@roborock-eu.com

Problem Type	Solution
Unable to power on	The battery level is low. Please put the main unit back onto the charging dock to charge it before use. Battery temperature is too low or too high. Please use the main unit in the range of 39°F (4°C) ~ 104°F (40°C).
Unable to charge	The charging dock is not plugged in. Please confirm the two ends of the power cable are properly plugged. Contact is poor. Please clean the contact tab on the charging dock and the charging contact on the main unit. Please confirm whether the charging indicator is on.
Slow charging speed	When used at high or low temperatures, the main unit will automatically reduce the charging speed so as to extend battery life. The charging contact areas may be dirty. Please use a dry cloth to clean such areas.
Unable to recharge	There are too many obstacles near the charging dock. Please place it in an open area. The main unit is too far from the charging dock. Please put it near the charging dock.
Abnormal behavior	Please power off and on the main unit.
Noise during cleaning	The main brush, side brush, Omni-directional wheel or main wheel may be entangled with foreign matters. Please clean them off after powering off.
Cleaning capacity decreased or dust dropped out	The dustbin is full. Please empty it. The filter is blocked. Please clean it. The main brush is entangled with foreign matters. Please clean them off.
Unable to connect to WIFI	WIFI is disabled. Please reset the WIFI and try again. WIFI signal is poor. Please make sure that the main unit is in an area with good WIFI signal reception. Abnormal WIFI connection: Please reset WIFI and download the latest mobile app to retry connecting.

Scheduled cleaning is not working	The battery level is low. Scheduled cleaning can start only if the battery level is above 20%.
Is the battery being drained if the main unit sits on the charging dock?	The battery usage is extremely low when the main unit sits on the charging dock, which helps maintain optimal battery performance.
Do I need to charge the battery for at least 16 hours for the first three uses?	The lithium battery has no memory effect, so it's okay to just fully charge it.
No or little water during mopping	Please check whether there is water in the water tank, adjust to water volume switch to high, rinse the mopping cloth, replace the filter, or follow the instructions in the user manual to correctly install the mopping cloth.
Too much water during mopping	Please make sure that the water tank cover and the filter are properly installed in place, and adjust the water volume switch to low.
Cleaning does not resume after recharging	Please make sure that the main unit is not in Do Not Disturb mode, as cleaning cannot resume in this mode. Cleaning resumption is not available in the case of manual recharge or putting the main unit onto the charging dock.
Unable to return to the dock charger after spot cleaning or position change	The main unit will re-generate a map after spot cleaning or a significant position change. If the charging dock is far away, the main unit may not be able to automatically return for recharge. Please put it onto the charging dock manually.



Robotic Vacuum Cleaner

Manufacturer: Beijing Roborock Technology Co.,Ltd.

Product Model: roborock S6

Address of Manufacturer: Floor 6, Suite 6016, 6017, 6018, Building C, Kangjian Baosheng Plaza,
No.8 Heiquan Road, Haidian District, Beijing, P.R.CHINA

For more product information, please visit our website: www.roborock.com

For after-sales support, please email our after-sales service team:

US/Non-Europe Support: support@roborock.com

Europe Support: support@roborock-eu.com