

# ⚠️ WARNING:

\*This product must not be in contact with fire sources or close to fire  
 \*Don't let children climb it at will  
 \*Guardians are not allowed to leave the site use when it's used by children  
 \*The packaging bag is not a toy, keep out of the reach of children  
 \*Please check whether the playpen is in good condition before use. If it is damaged, please do not use.  
 If there is any loose or missing fastener, loose joint, broken parts, or broken mesh / Cloth cover, it is forbidden to use this product. Please check before assembly and check regularly during use. Contact the manufacturer for replacement parts. No substitute is allowed.  
 Never use a water mattress with this product.  
 Infants can suffocate  
 In gaps between a mattress too small or too thick and product sides  
 On soft bedding  
 NEVER add a mattress, pillow, comforter, or padding.  
 Failure to follow these warnings and the instructions could result in serious injury or death.  
 The product, including side rails, must be fully erected prior to use.  
 Top support member must be installed prior to use. Failure to install may result in child falling out of product.  
 Strings can cause strangulation! Never place items with a string around a child's neck such as hood strings or pacifier cords. Never suspend strings over product or attach strings to toys.  
 Discontinue use of the product when child is able to climb out or reaches the height of 35 in. (890 mm).  
 Child can become entrapped and die when improvised netting or covers are placed on top of product . Never add such items to confine child in product .  
 When child is able to pull to standing position, remove bumper pads, large toys, and other objects that could serve as steps for climbing out.  
 Never place product near a window where cords from blinds or drapes can strangle a child.  
 Always provide the supervision necessary for the continued safety of your child. When used for playing, never leave child unattended.  
 If there are any loose or missing fasteners, loose joints, damaged parts, or damaged mesh / Cloth cover, do not use this product.  
 Please check before assembly and regularly during use. Contact the manufacturer for replacement parts. Substitutes are prohibited.  
 Never use a water mattress with this product.

# Playpen

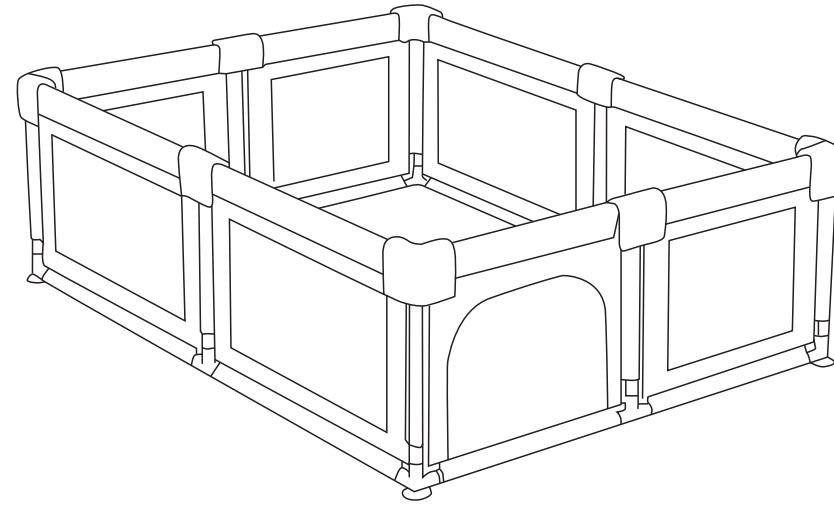

Model No.: GN-0002

KEEP INSTRUCTIONS FOR FUTURE  
 Use instruction for children's game fence

## Product information

Product Name: Children's playpen      Applicable age: 0+  
 Product material: Oxford cloth + pipe castings + sponges + plastics Usage scenarios: bedroom, living room, outdoor (flat ground), etc.

## Precautions

\*Please read this instruction carefully and keep it properly before use \*Do not bring the product close to sharp objects, keep away from fire and heat sources  
 \*This product is only a safety aid, and cannot replace adult supervision \* After the installation, please check frequently to ensure that the installation is correct and the function is normal  
 \*Do not wipe the product with corrosive chemical reagents

# ⚠️ WARNING

\*This product must not be in contact with fire sources or close to fire  
 \*Don't let children climb it at will  
 \*Guardians are not allowed to leave the site use when it's used by children  
 \*The packaging bag is not a toy, keep out of the reach of children  
 \*Please check whether the playpen is in good condition before use. If it is damaged, please do not use  
 \*Must be used under parental supervision.  
 \*Make sure the fence parts are stable during use.

## Important information

Open and remove all parts from the box, save the box and packaging materials until the product is fully assembled. If you find anything missing, please contact us immediately. In order to protect your playpen, please clean it with mild, non-friction detergent and water, other washing or abrasive materials may damage the product

## Pipe installation diagram for reference

59cm is vertical pipe, the installation position of other pipes please refer to the top view picture below

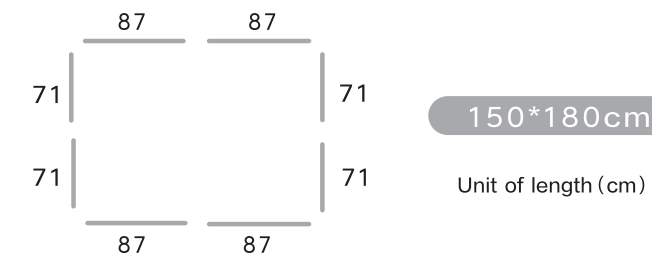

## List of accessories in the box 150\*180cm

Component	quantity	length (cm)	legend
87 Smooth pipe	4	87	
87 foam pipe	4	87	
71 Smooth pipe	4	71	
71 foam pipe	4	71	
59 foam pipe	8	59	
T-shaped tee	8		
corner tee	4		
sucker tee	4		

## Installation steps

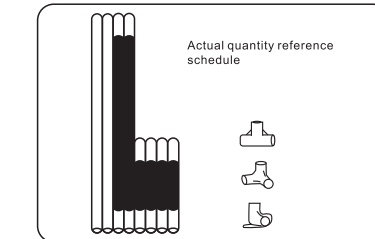

1. Put the received pipe fittings in order of length (do not to remove the sponge), confirm the number of three-way connectors

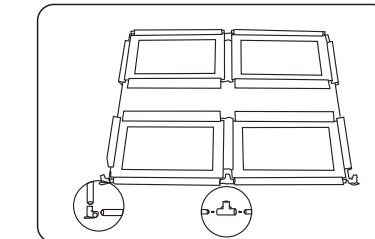

3.Take out sucker tees,corner tees and T-shaped tee to connect the pipe fittings around the bottom

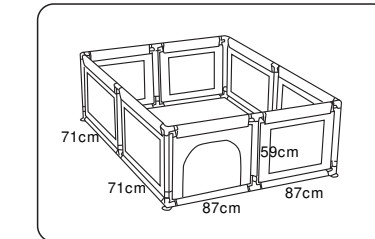

5.Install the corresponding pipes into the top cloth cover according to the step 2and 3, and connect with tees.

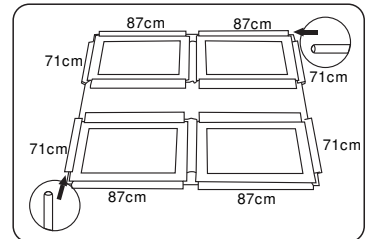

2.Spread the cloth cover on the ground, take out 71and 87 smooth pipes and insert into the corresponding positions around the cloth cover

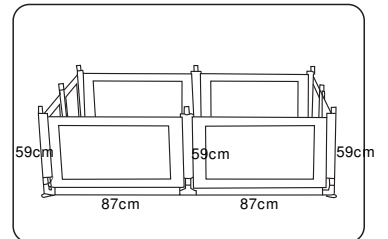

4.Take out 59 the pipes with sponge and insert into the vertical position around the cloth cover

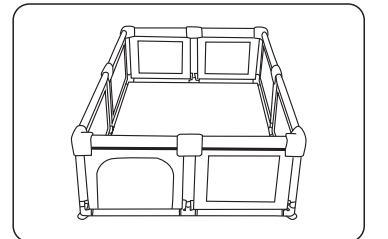

6.Paste the cotton ears on the top after the pipe fitting installation