

---

# DIMA CHAIR

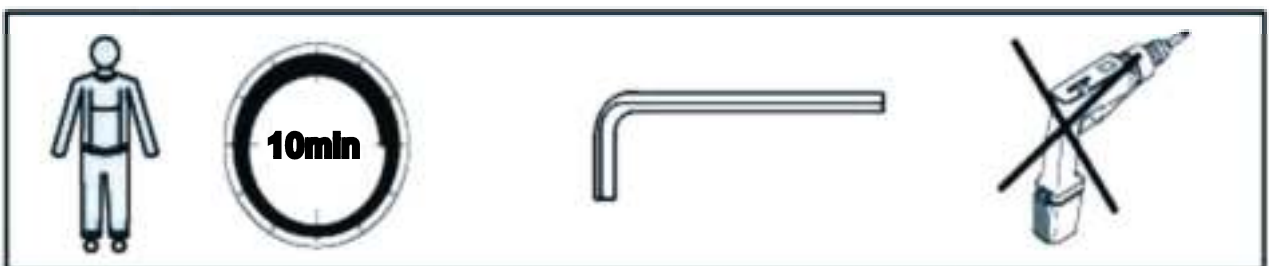

# DIMA CHAIR

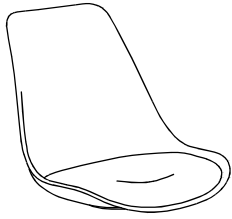

A × (1)

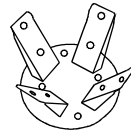

B × (1)



C × (4)

6\*32

6\*18

M6

6\*18\*1.2

M6

M5

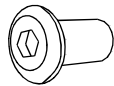
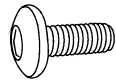
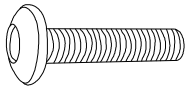

D × 8

E × 4

F × 8

G × 12

H × 1

I × 1

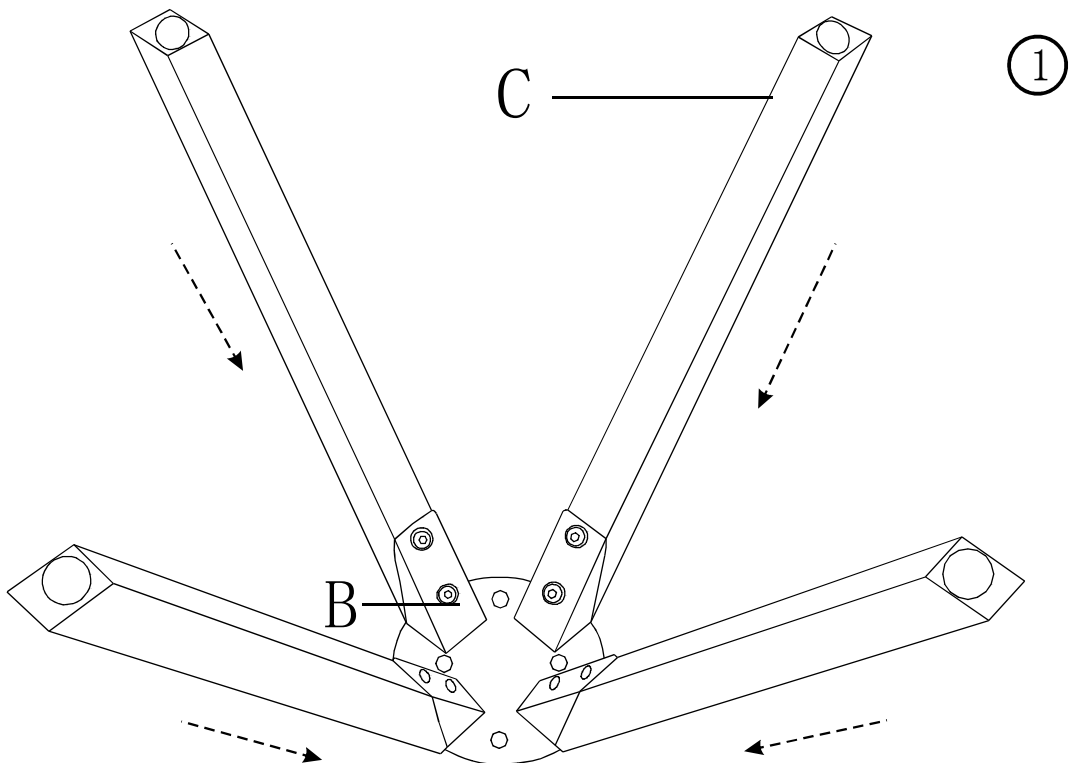

# DIMA CHAIR

  
D×8PCS

  
F×8PCS

  
G×8PCS

  
H×1PCS

  
I×1PCS

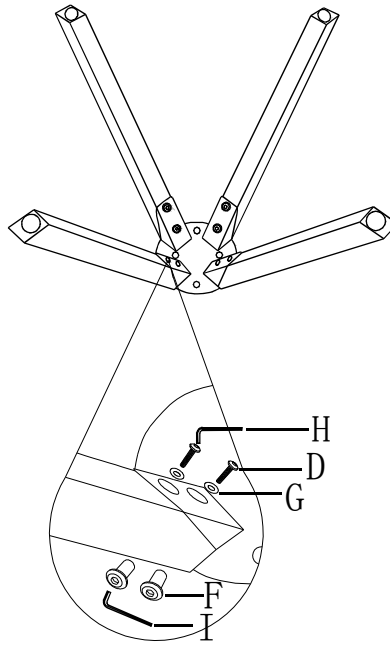

  
E×4PCS

  
G×4PCS

  
H×1PCS

