

# REMINGTON®

EST. NEW YORK 1937



## Omniblade Precision HG4000

 [remington-europe.com](http://remington-europe.com)

Register online for an EXTRA year guarantee

Visit [uk.remington-europe.com/product-registration](http://uk.remington-europe.com/product-registration) You must register within 28 days of purchase.

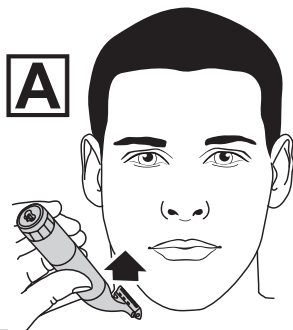
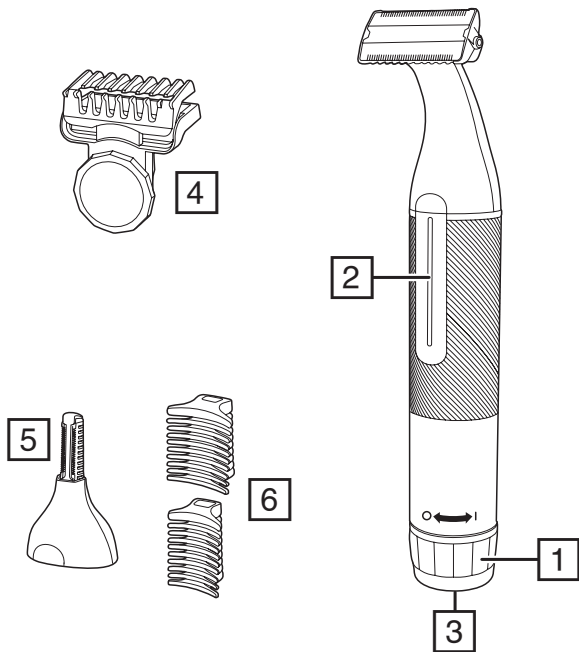

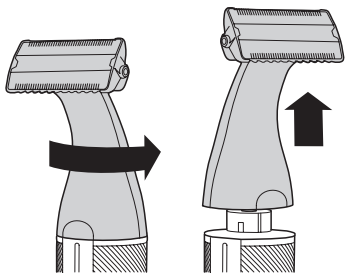
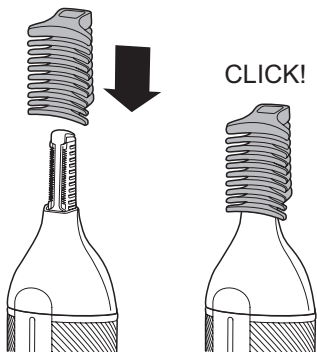
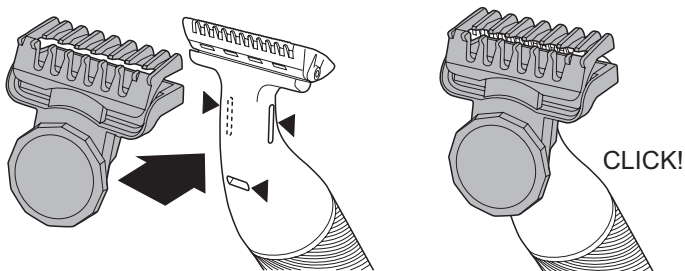
**B****C****D**

Thank you for buying your new Remington® product. Please read these instructions carefully and keep them safe. Remove all packaging before use.

---

## IMPORTANT SAFEGUARDS

---

- This appliance can be used by children aged from 8 years and above and persons with reduced physical, sensory or mental capabilities or lack of experience and knowledge if they have been supervised/instructed and understand the hazards involved. Children shall not play with the appliance. Cleaning and user maintenance shall not be done by children unless they are older than 8 and supervised. Keep the appliance and cable out of reach of children under 8 years.

 Suitable for use in a bath or shower.

- Do not use the product with a damaged cord.
- The battery in this device is not replaceable.
- Do not use the appliance if it is damaged or malfunctions.
- Do not use attachments other than those we supply.
- This appliance should never be left unattended when plugged into a power outlet, except when charging.
- Keep the power plug and cord away from heated surfaces.
- Do not plug or unplug the appliance with wet hands.
- Do not twist or kink the cable, or wrap it round the appliance.
- This appliance is not intended for commercial or salon use.

---

## PARTS

---



- |                              |                      |
|------------------------------|----------------------|
| 1. On/Off switch             | 6. 3 and 6 mm combs  |
| 2. Charging indicator light  | Not shown:           |
| 3. Charging connector        | • USB charging cable |
| 4. Adjustable precision comb | • Travel pouch       |
| 5. Micro trimmer             |                      |

## CHARGING YOUR APPLIANCE

It is recommended to fully charge your appliance before using it for the first time.

1. Ensure the product is switched off.
2. Connect the product to the USB cable and then to the USB end of the cable to a powered USB port.

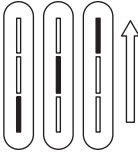
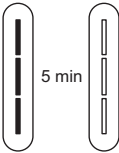
### CHARGING INDICATOR LIGHTS

Charging	Fully charged	Battery Low
		
The lights will come in a repeating sequence from bottom to top while charging	All lights will stay on for 5 minutes then go out.	The bottom light will flash for 5 seconds



Light off



Light on



Light flashing

- Your trimmer cannot be overcharged. However, if it is not going to be used for an extended period of time (2-3 months), unplug it from the mains supply.
- To preserve the life of your batteries, let them run out every 6 months then recharge for 2 hours.
- Run time from fully charged is up to 60 mins.

## ATTACHMENTS

### TO FIT AND REMOVE ATTACHMENTS (FIG. B)

Ensure that the device is switched off before fitting or removing attachments.

- To remove, rotate the attachment anti-clockwise until it unlocks and then lift it off.
- To fit, place the desired attachment on top of the device and rotate the attachment clockwise to lock it into place.

### **FITTING AND REMOVING THE ADJUSTABLE PRECISION COMB (FIG. D)**

- Clip the adjustable comb over the blade as shown ensuring that the three tabs on the comb fit into the notches on the back of the blade (shown by the ▲ marks).
- The 0.5 - 5 mm comb can be adjusted in 0.5mm increments simply by turning the wheel until the desired setting is shown on the scale. Turn the wheel clockwise for longer length and anticlockwise for shorter length.
- To remove, lift the back of the comb upwards and lift it off the blade.

---

## **INSTRUCTIONS FOR USE**

---

Switch the product on by rotating the on-off switch to the I mark.

Always comb your beard or moustache with a fine comb before you start trimming.

### **TO TRIM THE BEARD**

1. Fit the adjustable comb. If you are trimming for the first time start with the maximum trimming length setting.
2. Turn the unit on.
3. Place the flat top of the comb against the skin.
4. Slowly slide through the hair. Repeat from different directions as necessary.
5. If hair builds up in the trimmer comb during the trimming process, switch the unit off, pull off the comb and brush the hair off.

### **TO GET A SHAVEN LOOK**

To trim any length of beard or stubble hair for a clean, shaven look then follow the above steps without a comb attached to the blade head.

Place the flat top of the blade against the skin and slowly slide through the hair against the direction of growth.

Shave in an upwards direction when shaving under the chin (Fig. A).

### **TRIMMING AND EDGING**

1. Hold the device with the back side of the blade facing you with no comb attached.
2. Start with the blades resting lightly against your skin, use motions towards edge of beard line to trim to desired locations in facial area.
3. Shape as desired.

### **TRIMMING WITH SHAVING GEL**

Follow the same instructions as dry shaving if using shaving gel.

Caution: After use with shaving gel, please rinse the blade under warm water to clean away any excess gel and debris.

## DETAILED NOSE, EYEBROW AND EAR HAIR TRIMMING

<b>Attachments</b>
Micro trimmer

### **Nose and ear:**

1. Fit the micro trimmer.
  2. Insert the attachment gently into the nostril or ear.
  3. Gently move the attachment in and out while rotating the body of the groomer at the same time.
- Don't insert the attachment more than 6 mm.
  - Wash the attachment after each use.

### **Eyebrow:**

1. Slide the desired eyebrow comb attachment (3 or 6 mm) over the trimmer head (Fig. C).
2. Carefully guide the attachment to remove any stray or longer hairs from the eyebrow.
3. To completely remove hairs, let the attachment touch the skin then move over the desired area.

---

## CARE FOR YOUR GROOMER

---

Care for your product to ensure a long lasting performance. We recommend that you clean your groomer after each use.

### **AFTER EACH USE**

- Brush any accumulated hairs from the groomer and attachment heads.
- The easiest and most hygienic way to clean the groomer is by detaching the head from the groomer body and rinsing the head with warm water.
- Place one or two drops of cutter oil or sewing machine oil on the blades.
- Turn the device on to distribute the oil evenly, wipe off any excess oil.

---

## BATTERY REMOVAL

---

We strongly recommend that a professional removes the rechargeable battery. Parts of the shaver case, and tools have sharp edges and may cause injury if not handled correctly.

- The rechargeable battery must be removed from the appliance before it is scrapped.
1. Ensure the device is discharged of all power. To do this, switch it on and allow it to run until it stops.
  2. Remove any attachments.
  3. Pry off the switch button/switch cover.
  4. Unscrew the 2 screws under the cover then remove the lower housing.

5. Slide out the battery assembly.
  6. Unscrew the 2 screws from the cover then remove the battery.
- Used batteries must be removed from the appliance and disposed of at an appropriate official recycling/collection point.
  - Do not attempt to operate the device once you have opened it.

---

## RECYCLING

---



To avoid environmental and health problems due to hazardous substances, appliances and rechargeable and non-rechargeable batteries marked with one of these symbols must not be disposed of with unsorted municipal waste. Always dispose of electrical and electronic products and, where applicable, rechargeable and non-rechargeable batteries, at an appropriate official recycling/collection point.



---

## SERVICE AND GUARANTEE

---



Defects affecting product functionality appearing within the guarantee period will be corrected by replacement or repair at our option provided the product is used and maintained in accordance with the instructions. Your statutory rights are not affected.

This warranty shall not be valid where it is contrary to U.S. and other applicable laws, or where the warranty would be prohibited under any economic sanctions, export control laws, embargos, or other restrictive trade measures enforced by the United States or other applicable jurisdictions. This includes, without limitation, any warranty claims implicating parties from, or otherwise located in, Cuba, Iran, North Korea, Syria and the Crimea region.

To claim an extra 1 year guarantee, register your product online within 28 days of purchase.

Register at: <https://uk.remington-europe.com/product-registration>

Consumables are guaranteed only for their recommended lifecycle. Replacement/spare parts\* are excluded and are only covered by a 1 year warranty.

\*Examples include, but are not limited to, adaptors, haircare attachments, grooming accessories, etc.

---

## SERVICE CENTRE

---

### UNITED KINGDOM

 0800 212 438 (free call mainland UK)

Spectrum Brands (UK) Ltd  
Fir Street, Failsworth, Manchester  
M35 0HS, UK

[www.remington.co.uk](http://www.remington.co.uk)  
[productsupport@Remington.co.uk](mailto:productsupport@Remington.co.uk)

### IRELAND

 142 951 40

Remington Consumer Products,  
Unit B12, Ballymount Corporate Park,  
Ballymount, Dublin 12

<https://ie.remington-europe.com>  
[productsupport@Remington.co.uk](mailto:productsupport@Remington.co.uk)





# **Ref. No. HG4000**

## **Type No. HG03A**

20/UK/ HG4000 T22-7001373 Version 09 /20

Remington® is a Registered Trade Mark of Spectrum Brands, Inc., or one of its subsidiaries.

Spectrum Brands (UK) Ltd

Fir Street,

Failsworth,

Manchester

M35 0HS

[remington-europe.com](http://remington-europe.com)

© 2020 Spectrum Brands, Inc.