

**Setup Guide**  
**Guide de configuration**  
**Guía de instalación**  
**Guida all'installazione**  
**Einrichtungsanleitung**  
**Installatiehandleiding**  
**Kurulum Kılavuzu**

**EN**

**FR**

**ES**

**IT**

**DE**

**NL**

**TR**





# R40 Setup Guide

## STEP 1 ▶ Checking the Accessories

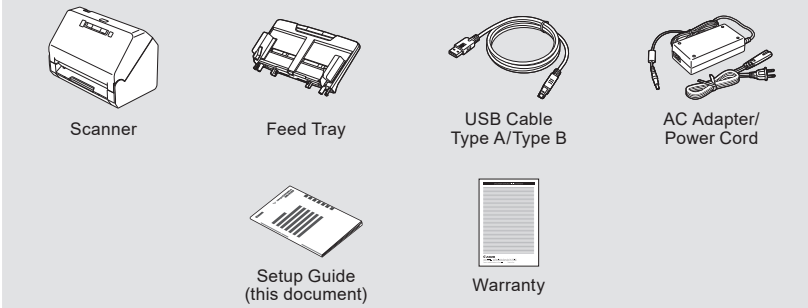

- Setup Disc is not included.
- Items included in this manual are subject to change without notice.
- You must keep the machine's packaging and packing materials for storing or transporting the machine.
- The shape of the power plug varies by country and region.

Remove the scanner from the box, and remove the protective sheets (▼) from the scanner.

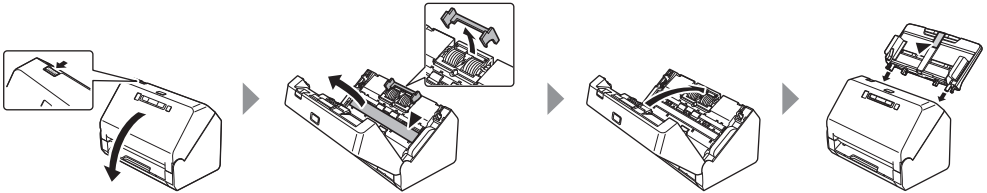

## STEP 2 ▶ Installing the Software

See Canon website for information on software updates.

### ! IMPORTANT

- Install the software before connecting the scanner to the computer.
- Log on to Windows as an Administrator.
- Close all other applications before installing the software.

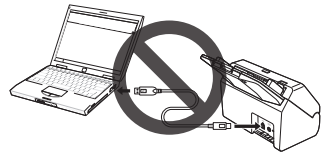

- 1 Download the software.



<https://software.canon-elec.co.jp/ims/r40>

- 2 Execute the downloaded software and follow the on-screen instructions.

Setup is complete.

# 1 Scan

## Load the document

### Hint

- Open the feed extension support ① when placing long documents.
- Erect the document eject stopper ② on the front edge if necessary.

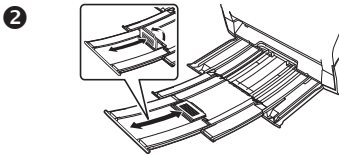
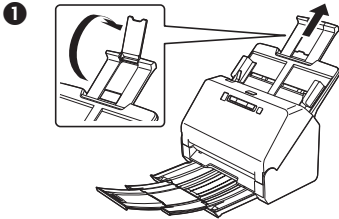

1 Adjust the document guides to fit the width of the document.

2 Load the document.

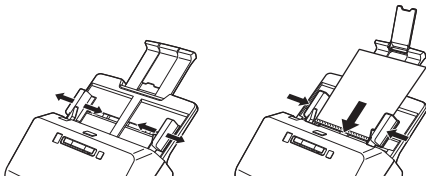

### Hint

- Load the documents facedown and the top edge first.

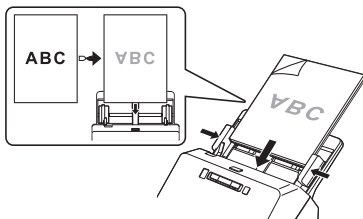

- When scanning a card, load it facedown and long edge first. Refer to User Manual for details.

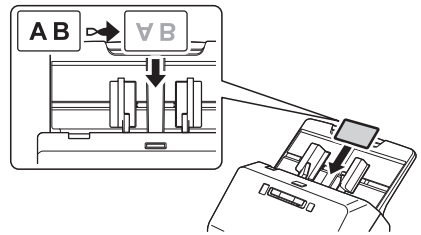

## Scanning with CaptureOnTouch

1 Click [Scan Single Sided] or [Scan Double Sided].



The scan setting can be changed using .

Also, you can create your own setting button using [New One Touch button].

2 Check the scanned image and click the [Finish] button.



Check, delete, and edit images.

Click  in the upper right of the screen for the usage details.

## 2 Other scanning method with CaptureOnTouch

### Standard Scanning

- 1 Select Document Type.
- 2 Select Destination.
- 3 Click [SCAN] button.

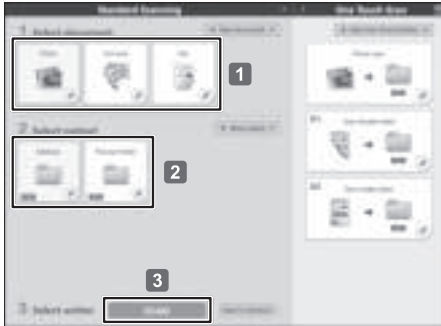

#### Hint

- Refer to the Help of CaptureOnTouch for details.

### Windows

Click , and select [Help] from the menu to open the Help.

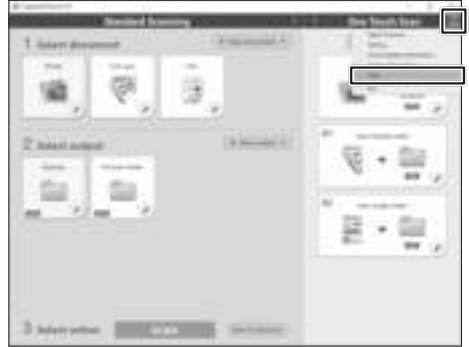

### Mac

Click [Help] in the menu bar and select [CaptureOnTouch Help].



### Scanning with Start Button

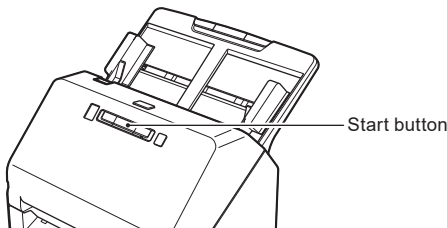

You can save frequently used settings as One Touch Buttons, which can be assigned to a numbered button on the scanner. This allows the user to begin a scan from pressing the Start button on the device. If you place the document, select a Job No. using the Job Select button and press the Start button, CaptureOnTouch will start and the document will be scanned.

Setting method:

Select a panel on [One Touch Scan] ⇒  ⇒ [Preferences] ⇒ [Assign this button to]

### Support TWAIN Interface

- Compatible with TWAIN application.
- Refer to the TWAIN application manual for details.

## Help

### ■ User Manual

Windows : [Start] - [Canon R40] - User Manual

Mac : [Applications] - [R40 User Manual]

### ■ CaptureOnTouch Help

Windows : Click the CaptureOnTouch icon in the taskbar, and select [Help] from the menu.

Mac : Click [CaptureOnTouch Help] from the [Help] menu while the main screen of CaptureOnTouch is displayed

### ■ Scanner Driver Help

Open the scanner driver from a TWAIN-compatible application, and click the [Help] button.

### ■ Technical support

[https://www.canon-europe.com/support/consumer\\_products/contact\\_support/](https://www.canon-europe.com/support/consumer_products/contact_support/)

### ■ Question about Readiris/Cardiris

By internet: <https://support.irislink.com>

By eMail: [helpdesk@irislink.com](mailto:helpdesk@irislink.com)

## Trademarks

- Canon and the Canon logo are registered trademarks, of Canon Inc. in the United States and may also be trademarks or registered trademarks in other countries.
- imageFORMULA is a trademark of CANON ELECTRONICS INC.
- Microsoft, Windows, PowerPoint, and SharePoint are registered trademarks or trademarks of Microsoft Corporation in the United States and other countries.
- Microsoft product screen shot(s) reprinted with permission from Microsoft Corporation.
- ENERGY STAR® is a registered trademark of the United States Environmental Protection Agency.
- macOS is a trademark of Apple Inc., registered in the U.S. and other countries.
- Other product and company names herein may be the trademarks of their respective owners. However, the ™ and ® symbols are not used in this document.

## Model Names

The following name may be provided for the safety regulations in each sales region of the Document Scanner.

R40: Model 6130190

## Copyright

Copyright 2021 by CANON ELECTRONICS INC. All rights reserved.

No part of this publication may be reproduced or transmitted in any form or by any means, electronic or mechanical, including photocopying and recording, or by any information storage or retrieval system without the prior written permission of CANON ELECTRONICS INC.

## Disclaimers

The information in this document is subject to change without notice.

CANON ELECTRONICS INC. MAKES NO WARRANTY OF ANY KIND WITH REGARD TO THIS MATERIAL, EITHER EXPRESS OR IMPLIED, EXCEPT AS PROVIDED HEREIN, INCLUDING WITHOUT LIMITATION, THEREOF, WARRANTIES AS TO MARKETABILITY, MERCHANTABILITY, FITNESS FOR A PARTICULAR PURPOSE OF USE OR NON-INFRINGEMENT. CANON ELECTRONICS INC. SHALL NOT BE LIABLE FOR ANY DIRECT, INCIDENTAL, OR CONSEQUENTIAL DAMAGES OF ANY NATURE, OR LOSSES OR EXPENSES RESULTING FROM THE USE OF THIS MATERIAL.

CANON ELECTRONICS INC. IS NOT LIABLE FOR THE STORAGE AND HANDLING OF DOCUMENTS SCANNED WITH THIS PRODUCT, OR THE STORAGE AND HANDLING OF RESULTING SCANNED IMAGE DATA. IF YOU INTEND TO DISCARD THE ORIGINALS OF SCANNED DOCUMENTS, YOU THE CUSTOMER ARE RESPONSIBLE FOR INSPECTING THE SCANNED IMAGES AND VERIFYING THAT DATA IS INTACT. THE MAXIMUM LIABILITY OF CANON ELECTRONICS INC. UNDER THIS WARRANTY IS LIMITED TO THE PURCHASE PRICE OF THE PRODUCT COVERED BY THE WARRANTY.

## R40 Guide de configuration

### ÉTAPE 1 ▶ Vérification des accessoires

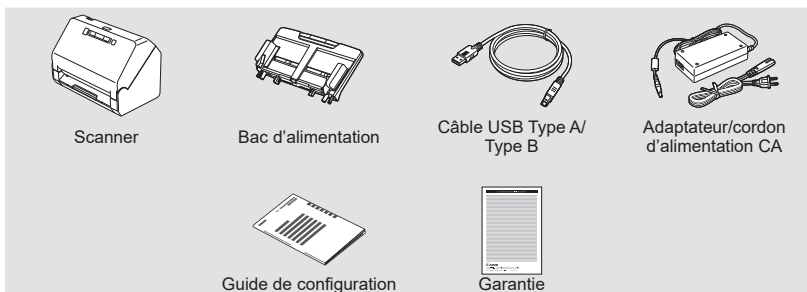

- Le disque d'installation n'est pas inclus.
- Les éléments inclus dans ce manuel sont soumis à modification sans préavis.
- Vous devez conserver l'emballage et les matériaux d'emballage de cet appareil afin de le ranger ou de le transporter.
- La forme de la fiche d'alimentation varie selon le pays et la région.

Retirez le scanner de la boîte, puis retirez les feuilles de protection (▼) du scanner.

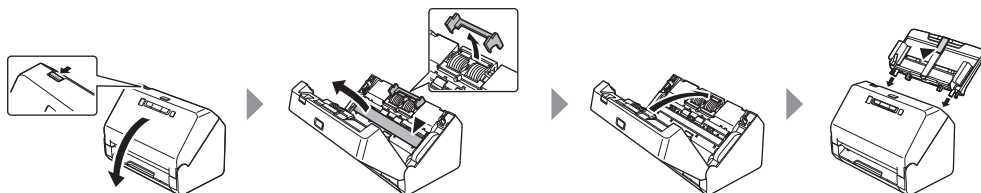

### ÉTAPE 2 ▶ Installation des logiciels

Consultez le site Web de Canon pour plus d'informations sur les mises à jour logicielles.

#### ❗ IMPORTANT

- Installez les logiciels avant de raccorder le scanner à l'ordinateur.
- Ouvrez une session Windows en tant qu'administrateur.
- Fermez toutes les autres applications avant d'installer les logiciels.



#### 1 Téléchargez le logiciel.



<https://software.canon-elec.co.jp/ims/r40>

#### 2 Exécutez le logiciel téléchargé et suivez les instructions à l'écran.

L'installation est terminée.

# 1 Numériser

## Chargez le document

### Indication

- Ouvrez le support d'extension d'alimentation **1** lorsque vous placez des documents longs.
- Redressez la butée d'éjection des documents **2** sur le bord avant si nécessaire.

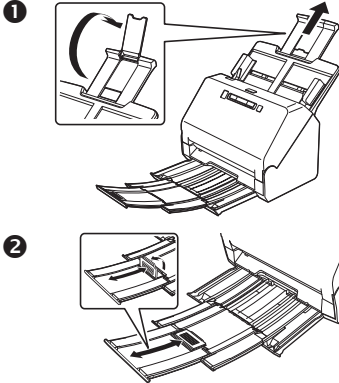

**1 Réglez les guides de document à la largeur du document.**

**2 Chargez le document.**

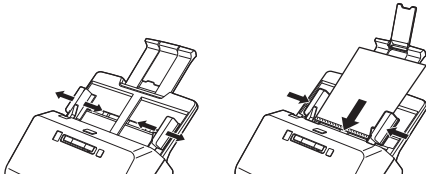

### Indication

- Chargez les documents face vers le bas et le bord supérieur en premier.

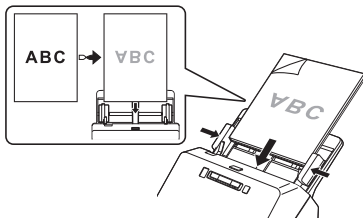

- Lorsque vous numériser une carte, chargez-la face vers le bas et le bord long en premier. Reportez-vous au mode d'emploi pour plus de détails.

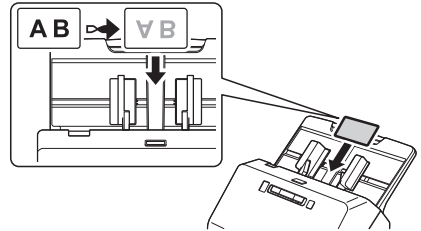

## Numériser avec CaptureOnTouch

**1 Cliquez sur [Numériser le recto du document] ou [Numériser le document recto-verso].**



Le réglage de numérisation peut être modifié en utilisant .

Vous pouvez également créer votre propre bouton de réglage en utilisant [Nouveau raccourci].

**2 Vérifiez l'image numérisée et cliquez sur le bouton [Terminer].**



Vérifiez, supprimez et modifiez les images.

Cliquez sur **2** en haut à droite de l'écran pour les détails d'utilisation.



## 2 Autre méthode de numérisation avec CaptureOnTouch

### Numérisation standard

- 1 Sélectionnez le type de document.
- 2 Sélectionnez la destination.
- 3 Cliquez sur le bouton [NUMÉRISER].

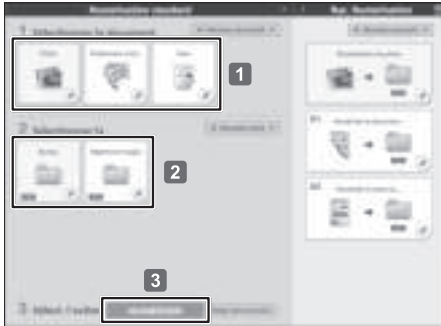

#### Indication

- Pour en savoir plus, référez-vous à l'Aide de CaptureOnTouch.

### Windows

Cliquez sur , et sélectionnez [Aide] depuis le menu pour ouvrir l'Aide.

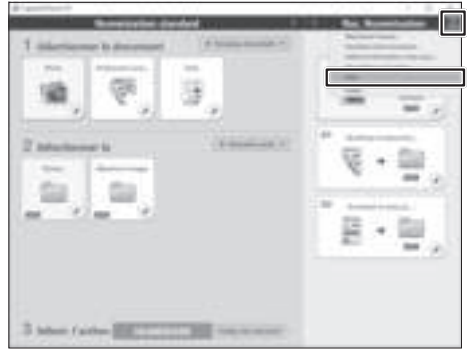

### Mac

Cliquez sur [Aide] dans la barre de menu et sélectionnez [Aide CaptureOnTouch].



### Numériser avec le bouton Start

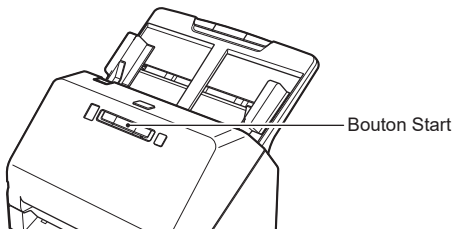

Vous pouvez enregistrer les paramètres fréquemment utilisés sous la forme de boutons de raccourci, qui peuvent être attribué d'un bouton numéroté sur le scanner. Ceci permet à l'utilisateur de commencer une numérisation en appuyant sur le bouton de démarrage sur l'appareil.

Si vous placez le document, sélectionnez le numéro de tâche à l'aide du bouton de sélection de travail et appuyez sur le bouton Start ; CaptureOnTouch démarre et le document est numérisé.

Méthode de réglage :

Sélectionnez un panneau sur [Rac. Numérisation] ⇒  ⇒ [Option] ⇒ [Attribution de bouton]

### Prise en charge de l'interface TWAIN

- Compatible avec l'application TWAIN.
- Reportez-vous au mode d'emploi de l'application TWAIN pour plus de détails.

### ■ Mode d'emploi

Windows : [Démarrer] - [Canon R40] - Mode d'emploi

Mac : [Applications] - [R40 Mode d'emploi]

### ■ Aide de CaptureOnTouch

Windows : Cliquez sur l'icône CaptureOnTouch dans la barre des tâches, puis sélectionnez [Aide] dans le menu.

Mac : Cliquez sur [Aide CaptureOnTouch] dans le menu [Aide] quand l'écran principal de CaptureOnTouch est affiché.

### ■ Aide du pilote du scanner

Ouvrez le pilote du scanner à partir d'une application compatible TWAIN, puis cliquez sur le bouton [Aide].

### ■ Support technique

[https://www.canon-europe.com/support/consumer\\_products/contact\\_support/](https://www.canon-europe.com/support/consumer_products/contact_support/)

### ■ Questions à propos de Readiris/Cardiris

Par internet : <https://support.irislink.com>

Par e-mail : [helpdesk@irislink.com](mailto:helpdesk@irislink.com)

### Marques commerciales

- Canon et le logo Canon sont des marques déposées de Canon Inc. aux États-Unis et peuvent être aussi des marques commerciales ou des marques déposées dans d'autres pays.
- imageFORMULA est une marque commerciale de CANON ELECTRONICS INC.
- Microsoft, Windows, PowerPoint et SharePoint sont des marques déposées ou commerciales de Microsoft Corporation aux États-Unis et dans d'autres pays.
- Capture(s) d'écran des produits Microsoft réimprimées avec l'autorisation de Microsoft Corporation.
- ENERGY STAR® est une marque déposée aux États-Unis.
- macOS est une marque commerciale de Apple Inc., déposée aux États-Unis et dans d'autres pays.
- D'autres noms de produits et d'entreprises ci-inclus peuvent être des marques de fabrique de leurs propriétaires respectifs. Cependant, les symboles ™ et ® ne sont pas utilisés dans ce document.

### NOMS DES MODELES

Les noms suivants seront fournis dans le règlement de sécurité de chaque zone de vente de cette Scanner de documents.

6130190: Modèle R40

### Copyright

Copyright 2021 by CANON ELECTRONICS INC. Tous droits réservés.

Aucune partie de cette publication ne peut être reproduite ou transmise, sous quelque forme ou de quelque manière que ce soit, électronique, mécanique, par photocopie, par enregistrement, à l'aide d'un système de stockage de des informations ou d'un système documentaire sans l'autorisation écrite préalable de CANON ELECTRONICS INC.

### Dégagement de responsabilité

Les informations incluses dans ce manuel sont soumises à des modifications sans préavis.

CANON ELECTRONICS INC. N'ASSUME AUCUNE RESPONSABILITE DE QUELQUE SORTE QUE CE SOIT CONCERNANT CE MATERIEL, EXPLICITE OU IMPLICITE, A L'EXCEPTION DE CE QUI INDIQUE CI-APRES, Y COMPRIS MAIS NON LIMITE A, TOUTE GARANTIE DE COMMERCIALISATION, VALEUR MARCHANDE, FITNESS A TITRE PARTICULIER OU SANS DEROGATION. CANON ELECTRONICS INC. NE PEUT ETRE TENU RESPONSABLE POUR TOUT DOMMAGE, DIRECT, INDIRECT OU LATERAL DE QUELQUE NATURE QUE CE SOIT OU POUR TOUTE PERTE OU DEPENSES SUITE A L'UTILISATION DE CE MATERIEL.

CANON ELECTRONICS INC. NE PEUT ETRE TENU RESPONSABLE POUR LE STOCKAGE OU LA MANIPULATION DE DOCUMENTS NUMERISES AVEC CET APPAREIL OU DES DONNEES D'IMAGES NUMERISEES OBTENUES. SI VOUS DECIDEZ DE JETER LES ORIGINAUX DES DOCUMENTS NUMERISES, VOUS ETES, EN TANT QU'UTILISATEUR, RESPONSABLE DE L'INSPECTION DES IMAGES NUMERISEES ET DE LA VERIFICATION QUE LES DONNEES SOIENT INTACTES.

LA RESPONSABILITE MAXIMALE DE CANON ELECTRONICS INC. DANS CETTE GARANTIE EST LIMITEE AU PRIX D'ACHAT DE CE PRODUIT COUVERT PAR CETTE GARANTIE.

## R40 Guía de instalación

### PASO 1 ▶ Comprobación de los accesorios

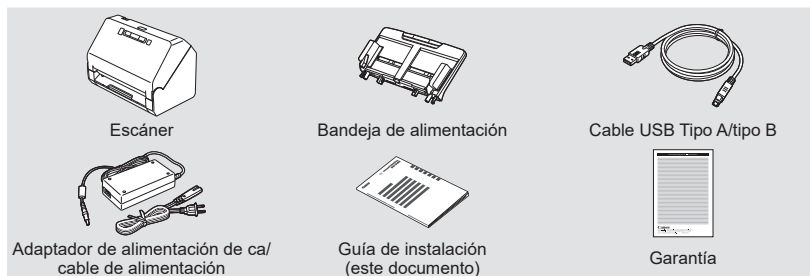

- No se incluye el disco de instalación.
- Los elementos incluidos en este manual están sujetos a cambios sin previo aviso.
- Conserve el embalaje del equipo y los materiales de embalaje para su almacenamiento o transporte.
- La forma del enchufe de alimentación varía según el país y la región.

Extraiga el escáner de la caja y retire las hojas protectoras (▼) del escáner.

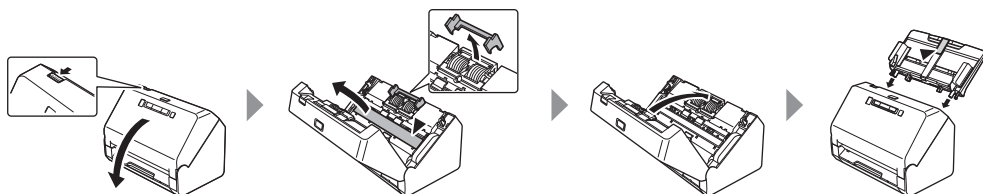

### PASO 2 ▶ Instalación del software

Consulte el sitio web de Canon para obtener más información acerca de las actualizaciones de software.

#### ⚠ IMPORTANTE

- Instale el software antes de conectar el escáner al ordenador.
- Inicie sesión en Windows como Administrador.
- Cierre el resto de aplicaciones antes de instalar el software.



#### 1 Descargue el software.



<https://software.canon-elec.co.jp/ims/r40>

#### 2 Ejecute el software descargado y después siga las instrucciones de la pantalla.

La configuración se ha completado.

# 1 Escanear

## Cargue el documento

### Sugerencia

- Abra el soporte de extensión de alimentación **1** cuando coloque documentos largos.
- Instale el tope de la salida de documentos **2** en el borde delantero, si es necesario.

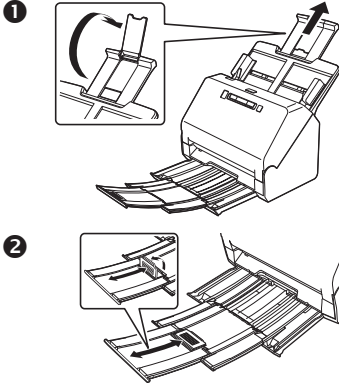

**1** Ajuste las guías de documentos al ancho del documento.

**2** Cargue el documento.

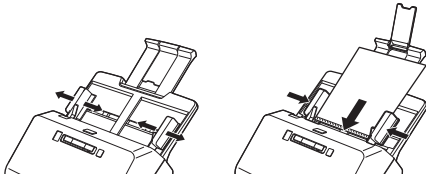

### Sugerencia

- Cargue los documentos con la cara de impresión hacia abajo y alimentando primero el borde superior.

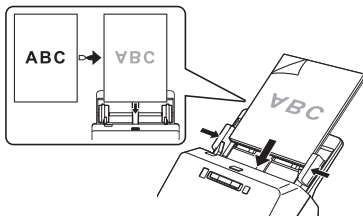

- Al escanear una tarjeta, colóquela boca abajo y alimentando primero el borde largo. Consulte el Manual del usuario para obtener información detallada.

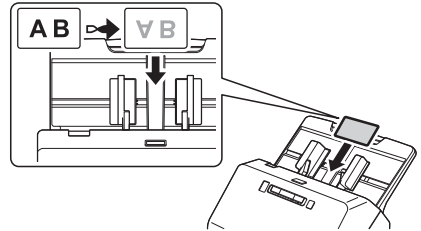

## Escanear con CaptureOnTouch

**1** Haga clic en [Escanear a una cara] o en [Escanear a doble cara].



La configuración de escaneo se puede cambiar utilizando .

Además, también puede crear su propio botón de configuración utilizando [Nuevo atajo].

**2** Compruebe la imagen escaneada y haga clic en el botón [Finalizar].



Compruebe, elimine y edite imágenes.

Haga clic en  en la parte superior derecha de la pantalla para ver los detalles de uso.

## 2 Otro método de escaneo con CaptureOnTouch

### Escaneo estándar

- 1 Seleccione el tipo de documento.
- 2 Seleccione un destino.
- 3 Haga clic en el botón [ESCANEAR].

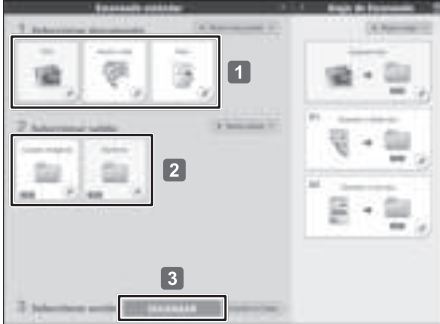

#### Sugerencia

- Consulte la Ayuda de CaptureOnTouch para obtener más información.

### Windows

Haga clic en  y seleccione [Ayuda] en el menú para abrir la Ayuda.



### Mac

Haga clic en [Ayuda] en la barra de menús y seleccione [Ayuda CaptureOnTouch].



### Escanear con el Botón Iniciar

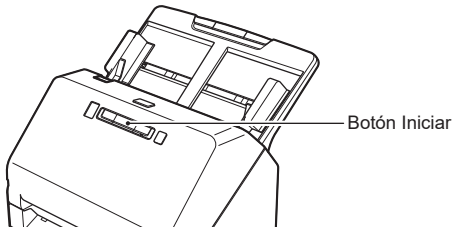

Puede guardar frecuentemente los ajustes utilizados como botones de una sola pulsación, que pueden asignarse a un botón de número en el escáner. Esto permite que el usuario comience a escanear pulsando el botón Iniciar en el dispositivo.

Si coloca el documento, seleccione un número de trabajo mediante el botón Seleccionar trabajo y pulse el botón Iniciar; CaptureOnTouch se iniciará y el documento se escaneará.

Método de configuración:

Seleccione un panel en [Atajo de Escaneo] ⇒  ⇒ [Opción] ⇒ [Asignación de botones]

### Compatibilidad con interfaz TWAIN

- Compatible con la aplicación TWAIN.
- Consulte el manual de la aplicación TWAIN para obtener más información.

## Ayuda

### ■ Manual del usuario

Windows : [Inicio] - [Canon R40] - Manual del usuario

Mac : [Aplicaciones] - [R40 Manual del Usuario]

### ■ Ayuda de CaptureOnTouch

Windows : Haga clic en el icono de CaptureOnTouch situado en la barra de tareas y seleccione [Ayuda] en el menú.

Mac : Haga clic en la opción [Ayuda CaptureOnTouch] del menú [Ayuda] mientras está abierta la pantalla principal de CaptureOnTouch.

### ■ Ayuda del controlador del escáner

Abra el controlador del escáner desde una aplicación compatible con TWAIN y haga clic en el botón [Ayuda].

### ■ Soporte técnico

[https://www.canon-europe.com/support/consumer\\_products/contact\\_support/](https://www.canon-europe.com/support/consumer_products/contact_support/)

### ■ Pregunta acerca de Readiris/Cardiris

Por internet : <https://support.irislink.com>

Por email: [helpdesk@irislink.com](mailto:helpdesk@irislink.com)

## Marcas comerciales

- Canon y el logotipo de Canon son marcas comerciales registradas de Canon Inc. en los Estados Unidos y es posible que también sean marcas comerciales o marcas comerciales registradas en otros países.
- imageFORMULA es una marca comercial de CANON ELECTRONICS INC.
- Microsoft, Windows, PowerPoint y SharePoint son marcas comerciales o marcas comerciales registradas de Microsoft Corporation en los Estados Unidos y otros países.
- Las capturas de pantalla de productos de Microsoft se han vuelto a imprimir con permiso de Microsoft Corporation.
- macOS es una marca comercial de Apple Inc., registrada en los Estados Unidos y en otros países.
- Otros nombres de productos o empresas que aparezcan en este documento pueden ser marcas comerciales de sus respectivos propietarios. Sin embargo, en este documento no se utilizan los símbolos ™ y ®.

## NOMBRES DE LOS MODELOS

Puede proporcionarse el siguiente nombre para la normativa de seguridad en cada una de las regiones de venta de este Escáner de documentos.

R40: modelo 6130190

## Copyright

Copyright 2021 de CANON ELECTRONICS INC. Reservados todos los derechos.

Queda prohibida la reproducción de cualquier parte de esta publicación, así como su transmisión, de ninguna forma ni por ningún medio, ya sea electrónico o mecánico, como la fotocopia o la grabación, o mediante cualquier sistema de almacenamiento o recuperación de datos sin la autorización previa por escrito de CANON ELECTRONICS INC.

## Renuncias

La información de este documento puede ser modificada sin previo aviso.

CANON ELECTRONICS INC. NO CONCEDE GARANTÍA ALGUNA SOBRE ESTE MATERIAL, YA SEA DE FORMA EXPLÍCITA O IMPLÍCITA, EXCEPTO LO ESTIPULADO EN ESTE DOCUMENTO, INCLUIDAS, ENTRE OTRAS, LAS GARANTÍAS DE COMERCIABILIDAD, IDONEIDAD PARA UN PROPÓSITO O USO CONCRETO O INCUMPLIMIENTO. CANON ELECTRONICS INC. NO ASUME NINGUNA RESPONSABILIDAD EN CUANTO A LOS DAÑOS DIRECTOS, FORTUITOS O RESULTANTES, INDEPENDIEMENTE DE LA NATURALEZA DE ESTOS, O EN CUANTO A LAS PÉRDIDAS O GASTOS QUE SE DERIVEN DEL USO DE ESTE MATERIAL.

CANON ELECTRONICS INC. NO ES RESPONSABLE DEL ALMACENAMIENTO Y MANIPULACIÓN DE LOS DOCUMENTOS ESCANEADOS CON ESTE PRODUCTO NI DEL ALMACENAMIENTO O MANIPULACIÓN DE LOS CORRESPONDIENTES DATOS DE LAS IMÁGENES ESCANEADAS.

SI PRETENDE ELIMINAR LOS ORIGINALES DE DOCUMENTOS ESCANEADOS, USTED, COMO CLIENTE, ES RESPONSABLE DE EXAMINAR LAS IMÁGENES ESCANEADAS Y COMPROBAR QUE LOS DATOS CORRESPONDAN EXACTAMENTE CON EL ORIGINAL.

LA RESPONSABILIDAD MÁXIMA DE CANON ELECTRONICS INC. SEGÚN ESTA GARANTÍA SE LIMITA AL PRECIO DE COMPRA DEL PRODUCTO AL QUE CUBRE.

## R40 Guida all'installazione

### PASSAGGIO 1 Verifica degli accessori



- Il disco di configurazione non è incluso.
- Le informazioni contenute nel presente documento sono soggette a modifiche senza preavviso.
- Conservare gli imballi per facilitarne l'eventuale conservazione e trasporto dell'apparecchio.
- La conformazione della spina di alimentazione varia da paese a paese.

Rimuovere lo scanner dalla confezione e i fogli protettivi (▼) dallo scanner.

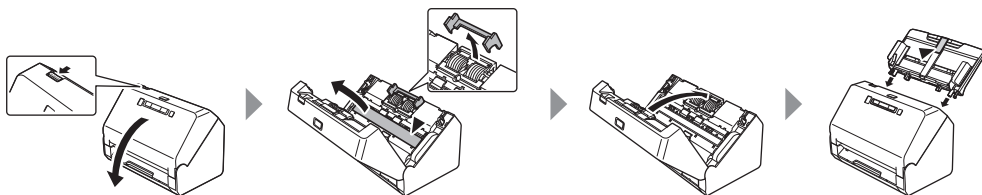

### PASSAGGIO 2 Installazione del software

Vedere il sito web Canon per informazioni sugli aggiornamenti software.

#### ❗ IMPORTANTE

- Installare il software prima di collegare lo scanner al computer.
- Accedere a Windows come amministratore.
- Chiudere tutte le altre applicazioni prima di avviare l'installazione del software.

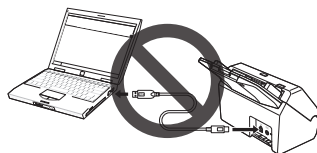

#### 1 Scaricare il software.



<https://software.canon-elec.co.jp/ims/r40>

#### 2 Eseguire il software scaricato e seguire le istruzioni sullo schermo.

La configurazione è completa.

# 1 Scansione

## Caricare il documento

### Suggerimento

- Aprire il supporto di estensione alimentazione **1** quando si posizionano documenti lunghi.
- Alzare il fermo di espulsione documento **2** sul bordo anteriore, se necessario.

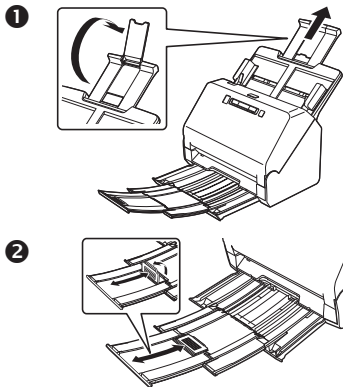

**1** Regolare le guide del documento in base alla larghezza del documento.

**2** Caricare il documento.

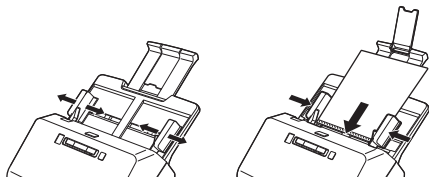

### Suggerimento

- Caricare i documenti rivolti a faccia in giù e con il bordo superiore per primo.

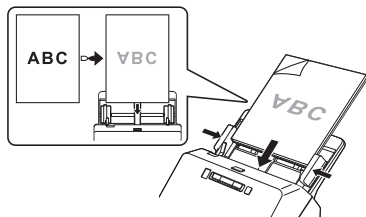

- Quando si esegue la scansione di una tessera, caricarla a faccia in giù e con il bordo lungo per primo.  
Fare riferimento al Manuale utente per i dettagli.

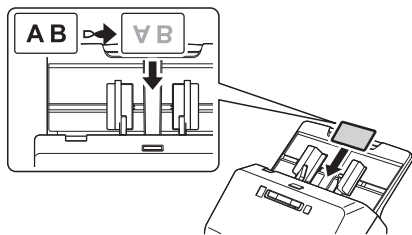

## Scansione con CaptureOnTouch

**1** Fare clic su [Scansiona un solo lato] o [Scansiona fronte-retro].



L'impostazione di scansione può essere modificata utilizzando .

Inoltre, è possibile creare il proprio pulsante di impostazione utilizzando [Nuovo collegamento].

**2** Controllare l'immagine sottoposta a scansione e fare clic sul pulsante [Fine].



Controllare, cancellare e modificare le immagini.  
Fare clic su  nella parte superiore destra dello schermo per i dettagli sull'utilizzo.



## 2 Altri metodi di scansione con CaptureOnTouch

### Scansione standard

- 1 Selezionare il tipo di documento.
- 2 Selezionare la destinazione.
- 3 Fare clic sul pulsante [SCANSIONE].

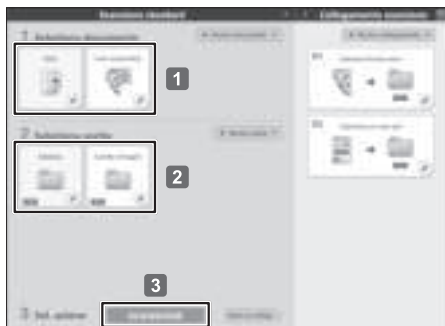

#### Suggerimento

- Fare riferimento alla Guida di CaptureOnTouch per i dettagli.

### Windows

Fare clic su , quindi selezionare [Guida] dal menu per aprire la Guida.



### Mac

Fare clic su [Aiuto] nella barra dei menu e selezionare [Aiuto CaptureOnTouch].



### Scansione con il pulsante di avvio

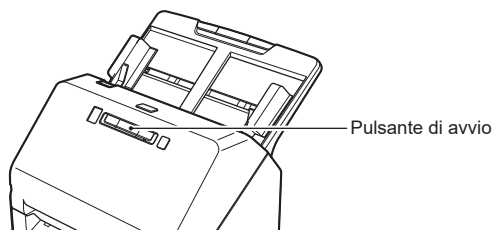

È possibile salvare le impostazioni utilizzate frequentemente come i pannelli Collegamento scansione, che possono essere assegnati a un pulsante numerato sullo scanner. Ciò consente all'utente di iniziare una scansione premendo il pulsante di avvio sul dispositivo.

Se si posiziona il documento, selezionare un numero di lavoro utilizzando il pulsante di selezione del lavoro e premere il pulsante di avvio; CaptureOnTouch si avvierà e il documento verrà sottoposto a scansione.

Metodo di impostazione:

Selezionare un pannello in [Collegamento scansione] ⇒  ⇒ [Opzione] ⇒ [Assegnazione pulsante:]

### Supporto dell'interfaccia TWAIN

- Compatibile con applicazioni TWAIN.
- Fare riferimento al manuale dell'applicazione TWAIN per i dettagli.

### ■ Manuale utente

Windows : [Start] - [Canon R40] - Manuale utente

Mac : [Applicazioni] - [R40 User Manual]

### ■ Aiuto CaptureOnTouch

Windows : Fare clic sull'icona CaptureOnTouch nella barra delle applicazioni, quindi selezionare [Guida] dal menu.

Mac : Fare clic su [Aiuto CaptureOnTouch] dal menu [Guida] mentre è visualizzata la schermata principale di CaptureOnTouch

### ■ Guida del driver dello scanner

Aprire il driver dello scanner da un'applicazione compatibile con TWAIN e fare clic sul pulsante [Guida].

### ■ Supporto tecnico

[https://www.canon-europe.com/support/consumer\\_products/contact\\_support/](https://www.canon-europe.com/support/consumer_products/contact_support/)

### ■ Domande su Readiris/Cardiris

Tramite Internet : <https://support.irislink.com>

Tramite e-mail : [helpdesk@irislink.com](mailto:helpdesk@irislink.com)

### Marchi di fabbrica

- Canon e il logo Canon sono marchi di fabbrica registrati di Canon Inc. negli Stati Uniti e potrebbero essere marchi di fabbrica o marchi di fabbrica registrati anche in altri Paesi.
- imageFORMULA è un marchio di CANON ELECTRONICS INC.
- Microsoft, Windows, PowerPoint e SharePoint sono marchi registrati o marchi di Microsoft Corporation negli Stati Uniti e in altri Paesi.
- Screenshot dei prodotti Microsoft stampate con il permesso di Microsoft Corporation.
- macOS è un marchio di Apple Inc., registrato negli Stati Uniti e in altri Paesi.
- Gli altri prodotti e le ragioni sociali citati nel presente documento sono marchi di fabbrica dei rispettivi proprietari. Nel documento, tuttavia, non si utilizzano i simboli ™ e ®.

### Nomi Modelli

Per la conformità alle normative di sicurezza nelle diverse aree di vendita, questo scanner per documenti potrà essere denominato anche come indicato di seguito.

R40: Modello 6130190

### Copyright

Copyright 2021 by CANON ELECTRONICS INC. Tutti i diritti riservati.

La presente pubblicazione non può essere riprodotta o trasmessa, in nessuna forma e attraverso nessun mezzo, elettronico o meccanico, né attraverso fotocopie o registrazioni né con sistemi di memorizzazione delle informazioni o di recupero senza previa autorizzazione scritta della CANON ELECTRONICS INC.

### Limitazione di responsabilità

Le informazioni contenute nel presente documento sono soggette a modifiche senza preavviso.

CANON ELECTRONICS INC. NON RICONOSCE NESSUNA GARANZIA DI NESSUN TIPO RELATIVAMENTE A QUESTO MATERIALE, ESPLICITA O IMPLICITA, ECCETTO QUANTO PREVISTO DAL PRESENTE DOCUMENTO. CIÒ COMPRENDE LE GARANZIE DI COMMERCIALIZZABILITÀ, IDONEITÀ AD UN USO PARTICOLARE O CONTRO LA VIOLAZIONE DI QUALSIASI BREVETTO. CANON ELECTRONICS C. NON SI REPUTA RESPONSABILE PER EVENTUALI DANNI DIRETTI, ACCIDENTALI O CONSEGUENZIALI DI QUALSIASI NATURA, O DI PERDITE O SPESE CAUSATI DALL'UTILIZZO DI QUESTO MATERIALE.

CANON ELECTRONICS INC. NON È RESPONSABILE DELLA MEMORIZZAZIONE E DELLA GESTIONE DEI DOCUMENTI SOTTOPOSTI A SCANSIONE CON IL PRODOTTO NÉ DELLA MEMORIZZAZIONE E DELLA GESTIONE DEI DATI DELLE IMMAGINI DIGITALIZZATE RISULTANTI. SE IL CLIENTE INTENDE ELIMINARE GLI ORIGINALI DEI DOCUMENTI SOTTOPOSTI A SCANSIONE, SPETTA AL CLIENTE ISPEZIONARE LE IMMAGINI DIGITALIZZATE E VERIFICARE CHE I DATI SIANO INTATTI. LA RESPONSABILITÀ MASSIMA DI CANON ELECTRONICS INC. PREVISTA DA QUESTA GARANZIA È LIMITATA AL PREZZO D'ACQUISTO DEL PRODOTTO COPERTO DALLA GARANZIA.

# R40 Einrichtungsanleitung

## SCHRITT 1 ▶ Prüfen des Zubehörs

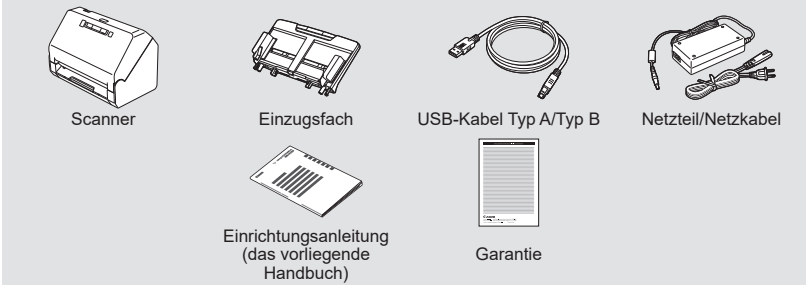

- Die Installations-Disc ist nicht enthalten.
- Die in diesem Handbuch beschriebenen Gegenstände und Verfahren können ohne vorherige Ankündigung geändert werden.
- Bewahren Sie die Originalverpackung und das Verpackungsmaterial des Geräts zu dessen Lagerung oder Transport auf.
- Die Form des Netzsteckers hängt vom jeweiligen Land bzw. von der Region ab.

Nehmen Sie den Scanner aus dem Karton, und entfernen Sie die Schutzblätter (▼) vom Scanner.

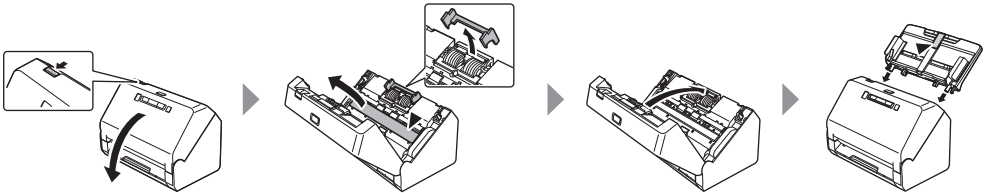

## SCHRITT 2 ▶ Installieren der Software

Informationen zu Softwareaktualisierungen finden Sie auf der Canon-Website.

### ❗ WICHTIG

- Installieren Sie die Software, bevor Sie den Scanner mit dem Computer verbinden.
- Melden Sie sich bei Windows als Administrator an.
- Schließen Sie alle anderen Anwendungen, bevor Sie die Software installieren.

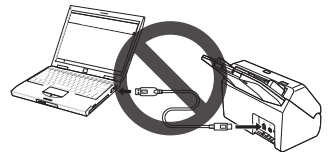

### 1 Herunterladen der Software.



<https://software.canon-elec.co.jp/ims/r40>

### 2 Führen Sie die heruntergeladene Software aus und folgen Sie den Anweisungen auf dem Bildschirm.

Die Einrichtung ist abgeschlossen.

# 1 Scannen

## Dokument laden

### Hinweis

- Öffnen Sie die Einzugsverlängerungsauflage **1** beim Ablegen langer Dokumente.
- Den Ausgabefachanschlag **2** an der Vorderkante aufstellen.

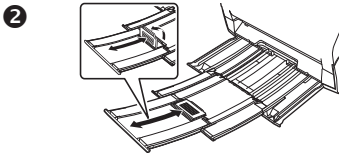
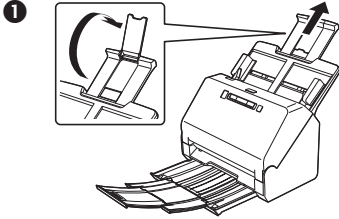

**1** Stellen Sie die Dokumentführungen entsprechend der Dokumentbreite ein.

**2** Dokument laden.

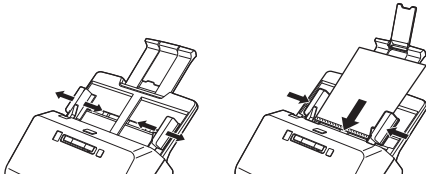

### Hinweis

- Legen Sie die Dokumente mit der bedruckten Seite nach unten und der Oberkante zuerst ein.

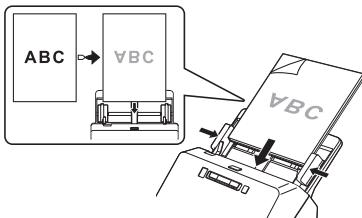

- Legen Sie eine Karte beim Scannen mit der Vorderseite nach unten und der langen Kante zuerst ein. Einzelheiten finden Sie in der Bedienungsanleitung.

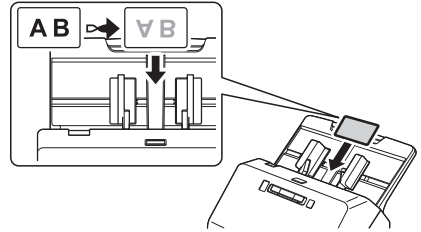

## Scannen mit CaptureOnTouch

**1** Klicken Sie auf [Scan einseitig] oder [Scan beidseitig].



Die Scan-Einstellung kann mit geändert werden. Außerdem können Sie mit [Neuer Shortcut] eine eigene Einstellungstaste erstellen.

**2** Prüfen Sie das gescannte Bild und klicken Sie auf [Fertig stellen].



Prüfen, löschen und bearbeiten Sie Bilder. Klicken Sie auf in der oberen rechten Ecke des Bildschirms, um die Nutzungsdetails anzuzeigen.

## 2 Andere Scanmethode mit CaptureOnTouch

### Standard-Scannen

- 1 Dokumententyp auswählen.
- 2 Ziel auswählen.
- 3 Klicken Sie auf [SCANNEN].

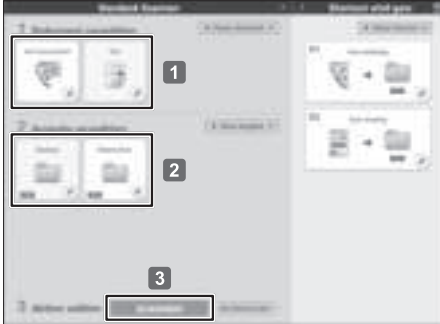

#### Hinweis

- Weitere Informationen finden Sie in der Hilfe von CaptureOnTouch.

### Windows

Klicken Sie auf  und wählen Sie [Hilfe] aus dem Menü, um die Hilfe zu öffnen.



### Mac

Klicken Sie in der Menüleiste auf [Hilfe] und wählen Sie [CaptureOnTouch-Hilfe].



### Scannen mit Starttaste

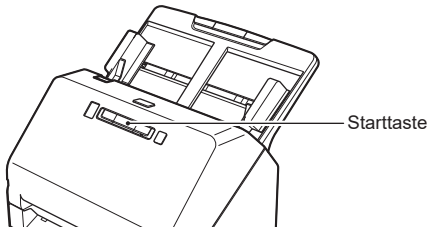

Sie können häufig verwendete Einstellungen als „Shortcut wird gesc“-Bedienfeld speichern, die einer nummerierten Taste am Scanner zugewiesen werden können. Dadurch kann der Benutzer durch Drücken der Starttaste am Gerät einen Scanvorgang starten.

Wenn Sie das Dokument einlegen, wählen Sie mit der Auftragswahltaete eine Auftragsnummer aus und drücken Sie die Starttaste. CaptureOnTouch wird gestartet und das Dokument wird gescannt.

Einstellverfahren:

Wählen Sie einen Bereich auf [Shortcut wird gesc] ⇒  ⇒ [Option] ⇒ [Tastenzuweisung:]

### Unterstützung der TWAIN-Oberfläche

- Kompatibel mit TWAIN-Programm.
- Einzelheiten dazu finden Sie im TWAIN-Programmhdbuch.

### ■ Bedienungsanleitung

Windows : [Start] - [Canon R40] - Bedienungsanleitung

Mac : [Programme] - [R40 User Manual]

### ■ CaptureOnTouch-Hilfe

Windows : Klicken Sie auf das CaptureOnTouch-Symbol in der Taskleiste und wählen Sie [Hilfe] aus dem Menü.

Mac : Klicken Sie auf [CaptureOnTouch-Hilfe] im Menü [Hilfe], während der Hauptbildschirm von CaptureOnTouch angezeigt wird

### ■ Scannertreiber-Hilfe

Öffnen Sie den Scannertreiber aus einem TWAIN-kompatiblen Programm und klicken Sie auf [Hilfe].

### ■ Technische Unterstützung

[https://www.canon-europe.com/support/consumer\\_products/contact\\_support/](https://www.canon-europe.com/support/consumer_products/contact_support/)

### ■ Fragen zu Readiris/Cardiris

Über Internet: <https://support.irislink.com>

Per E-Mail: [helpdesk@irislink.com](mailto:helpdesk@irislink.com)

## Marken

- Canon und das Canon-Logo sind registrierte Markenzeichen von Canon Inc. in den USA und können auch in anderen Ländern Markenzeichen bzw. registrierte Markenzeichen sein.
- imageFORMULA ist eine Marke von CANON ELECTRONICS INC.
- Microsoft, Windows, PowerPoint und SharePoint sind eingetragene Marken oder Marken der Microsoft Corporation in den USA und anderen Ländern.
- Die Abbildung der Screenshots von Microsoft Produkten erfolgt mit Genehmigung der Microsoft Corporation.
- macOS ist ein Warenzeichen von Apple Inc., eingetragen in den USA und anderen Ländern.
- Andere in diesem Dokument aufgeführte Produkt- und Firmennamen können Marken ihrer jeweiligen Eigentümer sein. Die Symbole <sup>TM</sup> und <sup>®</sup> werden in diesem Dokument allerdings nicht benutzt.

## Modellnamen

Der folgende Name kann in den einzelnen Verkaufsregionen des Dokumentenscanners in den Sicherheitsvorschriften genannt werden.

R40: Modell 6130190

## Copyright

Copyright 2021 CANON ELECTRONICS INC. Alle Rechte vorbehalten.

Kein Teil dieser Veröffentlichung darf ohne vorherige schriftliche Genehmigung von CANON ELECTRONICS INC. in irgendeiner Form oder mit irgendwelchen Mitteln (elektronisch oder mechanisch, durch Fotokopieren oder Tonaufnahme oder über ein Informationsspeicher- oder -abrufsystem) reproduziert oder übertragen werden.

## Haftungsausschluss

Die Informationen in diesem Dokument können ohne vorherige Ankündigung geändert werden.

CANON ELECTRONICS INC. ÜBERNIMMT WEDER AUSDRÜCKLICHE NOCH KONKLUDENTE GARANTIE IM HINBLICK AUF DIESES MATERIAL, DIE ÜBER DIE DARSTELLUNGEN IN DIESEM TEXT HINAUSGEHEN, INSBESONDERE KEINE GARANTIE DER HANDELSFÄHIGKEIT UND EIGNUNG FÜR EINEN BESTIMMTEN ZWECK ODER ÜBER DIE NICHTVERLETZUNG VON RECHTEN. CANON ELECTRONICS INC. HAFTET NICHT FÜR DIREKTE, FOLGE- ODER ZUFÄLLIG ENTSTANDENE SCHÄDEN JEDLICHER ART, ODER FÜR VERLUSTE UND AUSGABEN, DIE DURCH DIE VERWENDUNG DIESES MATERIALS ENTSTEHEN.

CANON ELECTRONICS INC. HAFTET NICHT FÜR DIE AUFBEWAHRUNG UND HANDHABUNG VON DOKUMENTEN, DIE MIT DIESEM PRODUKT GESCANNT WURDEN, ODER FÜR DIE SPEICHERUNG UND HANDHABUNG DER RESULTIERENDEN DATEN DER GESCANNTEN BILDER. WENN SIE BEABSICHTIGEN, DIE ORIGINALE GESCANNTER DOKUMENTE WEGZUWERFEN, SIND SIE, DER KUNDE, DAFÜR VERANTWORTLICH, DIE GESCANNTEN BILDER ZU ÜBERPRÜFEN UND SICHERZUSTELLEN, DASS DIE DATEN UNBESCHÄDIGT SIND.

DIE HAFTUNGSHÖCHSTGRENZE VON CANON ELECTRONICS INC. UNTER DIESER GARANTIE IST AUF DEN KAUFPREIS DES DURCH DIE GARANTIE ABGEDECKTEN PRODUKTS BESCHRÄNKT.

## R40 Installatiehandleiding

### STAP 1 ▶ De accessoires controleren

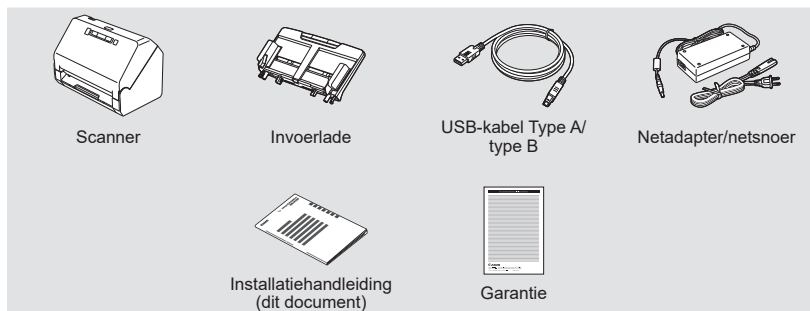

- Installatieschijf is niet inbegrepen.
- Onderdelen in deze handleiding kunnen zonder voorafgaand bericht worden gewijzigd.
- Bewaar de verpakking van het apparaat voor als u het apparaat wilt opslaan of vervoeren.
- De vorm van de netsnoerstekker verschilt van land tot land.

Neem de scanner uit de doos en verwijder de beschermingsvellen (▼) uit de scanner.

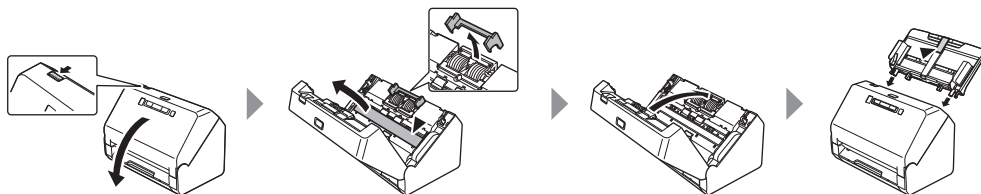

### STAP 2 ▶ De software installeren

Ga naar de Canon-website voor informatie over software-updates.

#### ⚠ ATTENTIE

- Installeer de software voordat u de scanner op de computer aansluit.
- Meld u bij Windows aan als administrator/beheerder.
- Sluit alle andere toepassingen voordat u de software installeert.

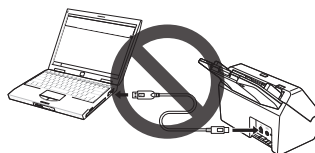

#### 1 De software downloaden.



<https://software.canon-elec.co.jp/ims/r40>

#### 2 Voer de gedownloade software uit en volg de instructies op het scherm.

De installatie is voltooid.

# 1 Scan

## Laad het document

### Wenk

- Open de invoerverlengsteun **1** wanneer u lange documenten plaatst.
- Plaats de documentuitvoerstop **2** indien nodig op de voorste rand.

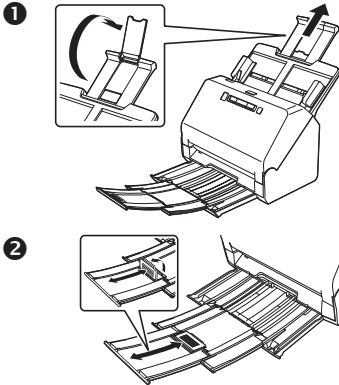

**1** Pas de documentgeleiders aan de breedte van het document aan.

**2** Laad het document.

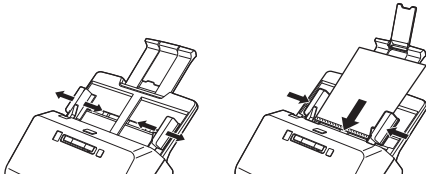

### Wenk

- Laad de documenten met de bedrukte zijde naar beneden en de bovenrand eerst.

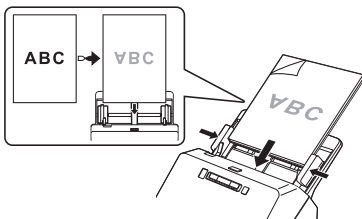

- Als u een kaart scant, plaatst u deze met de bedrukte zijde naar beneden en de lange zijde eerst.  
Raadpleeg de gebruikershandleiding voor meer informatie.

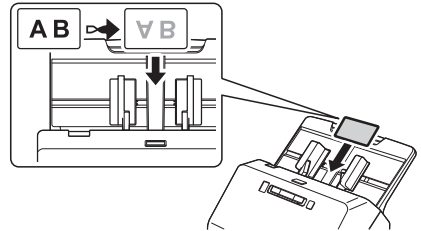

## Scannen met CaptureOnTouch

**1** Klik op [Enkelzijdig scannen] of [Dubbelzijdig scannen].



De scaninstelling kan worden gewijzigd met . U kunt ook uw eigen instellingtoets maken met behulp van de [Nieuwe sneltoets].

**2** Controleer de gescande afbeelding en klik op de toets [Voltoeien].



Beelden controleren, verwijderen en bewerken.  
Klik op in de rechterbovenhoek van het scherm voor de gebruiksgegevens.



## 2 Overige scanmethode met CaptureOnTouch

### Standaard scannen

- 1 Selecteer documenttype.
- 2 Selecteer bestemming.
- 3 Klik op de [SCAN]-toets.

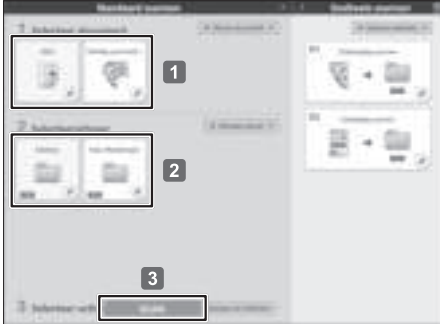

#### Wenk

- Raadpleeg de Helpfunctie van CaptureOnTouch voor meer informatie.

### Windows

Klik op  en selecteer [Help] in het menu om Help te openen.

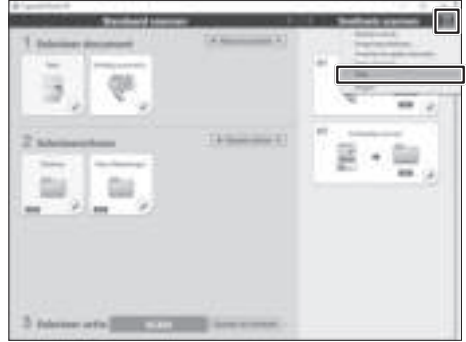

### Mac

Klik op [Help] in de menubalk en selecteer [CaptureOnTouch Help].



### Scannen met de Startknop

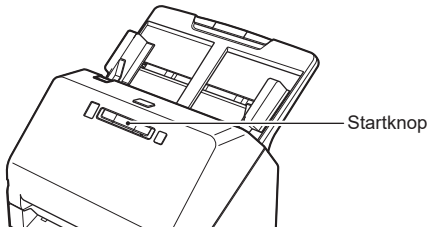

U kunt veelgebruikte instellingen opslaan als Sneltoetsen scannen-paneel, die kunnen worden toegewezen aan een genummerde toets op de scanner. Hiermee kan de gebruiker beginnen met scannen door de Startknop op het apparaat in te drukken.

Als u het document plaatst, selecteert u een taaknummer met de Odrachtselectietoets en drukt u op de Startknop. CaptureOnTouch zal starten en het document wordt gescand.

Instelmethode:

Selecteer een paneel bij [Sneltoets scannen] ⇒  ⇒ [Optie] ⇒ [Knoptoewijzing:]

### Ondersteuning TWAIN-interface

- Compatibel met TWAIN-programma's.
- Raadpleeg de handleiding van het TWAIN-programma voor meer informatie.

## Help

### ■ Gebruikershandleiding

Windows : [Starten] - [Canon R40] - Gebruikershandleiding

Mac : [Programma's] - [R40 User Manual]

### ■ CaptureOnTouch Help

Windows : Klik op het CaptureOnTouch-pictogram in de taakbalk en selecteer [Help] in het menu.

Mac : Klik op [CaptureOnTouch Help] in het menu [Help] terwijl het hoofdscherm van CaptureOnTouch wordt weergegeven

### ■ Scannerdriver Help

Open de scannerdriver vanuit een TWAIN-compatibel programma en klik op de [Help]-knop.

### ■ Technische ondersteuning

[https://www.canon-europe.com/support/consumer\\_products/contact\\_support/](https://www.canon-europe.com/support/consumer_products/contact_support/)

### ■ Vraag over Readiris/Cardiris

Via internet: <https://support.irislink.com>

Via e-mail: [helpdesk@irislink.com](mailto:helpdesk@irislink.com)

## Merken

- Canon en het Canon-logo zijn geregistreerde merken van Canon Inc. in de Verenigde Staten en kunnen ook merken of geregistreerde merken zijn in andere landen.
- imageFORMULA is een merk van CANON ELECTRONICS INC.
- Microsoft, Windows, PowerPoint en SharePoint zijn geregistreerde merken of merken van Microsoft Corporation in de Verenigde Staten en andere landen.
- Schermafbeelding(en) van Microsoft producten gereproduceerd met toestemming van de Microsoft Corporation.
- macOS is een handelsmerk van Apple Inc., geregistreerd in de VS en andere landen.
- Andere producten en bedrijfsnamen hierin vermeld kunnen merken zijn van de respectieve eigenaren. De symbolen ™ en ® worden echter in dit document niet gebruikt.

## Modelnamen

De volgende modelnummers kunnen worden genoemd in de veiligheidsvoorschriften voor de diverse gebieden waar deze documentscanner te koop is.

R40: Model 6130190

## Copyright

Copyright 2021 door CANON ELECTRONICS INC. Alle rechten voorbehouden.

Niets uit deze publicatie mag worden veeleenvoudigd of overgebracht in enige vorm of op enige manier, hetzij elektronisch of mechanisch, met inbegrip van fotokopiëren en opnames, of opgeslagen in een geautomatiseerd gegevensbestand zonder voorafgaande schriftelijke toestemming van CANON ELECTRONICS INC.

## Afwijzing van aansprakelijkheid

De informatie in dit document kan zonder voorafgaande melding worden gewijzigd.

CANON ELECTRONICS INC. GEEFT GEEN GARANTIE VAN WELKE AARD DAN OOK MET BETREKKING TOT DIT MATERIAAL, NOCH UITDRUKKELIJK NOCH IMPLICIET, BEHALVE WAT IN DEZE IS VOORZIEN, INCLUSIEF EN ZONDER BEPERKING, DAARVAN, GARANTIES MET BETREKKING TOT VERKOOPBAARHEID, VERHANDELBAARHEID, GESCHIKTHEID VOOR EEN BEPAALD DOEL OF GEBRUIK OF NIET SCHENDEN. CANON ELECTRONICS INC. STELT ZICH NIET AANSPRAKELIJK VOOR ENIGE RECHTSTREEKSE, TOEVALLIGE OF GEVOLGSCHADE VAN WELKE AARD DAN OOK, OF VOOR VERLIES OF KOSTEN DIE UIT HET GEBRUIK VAN DIT MATERIAAL VOORTVLOEIEN.

CANON ELECTRONICS INC. IS NIET AANSPRAKELIJK VOOR DE OPSLAG EN HET GEBRUIK VAN DOCUMENTEN DIE MET DIT PRODUCT ZIJN GESCAND, OF VOOR DE OPSLAG EN HET GEBRUIK VAN RESULTERENDE GESCANDE BEELDGEGEVENS.

ALS U DE ORIGINELEN VAN GESCANDE DOCUMENTEN WILT AFVOEREN, BENT U, DE KLANT, VERANTWOORDELIJK VOOR CONTROLE VAN DE GESCANDE BEELDEN OM VAST TE STELLEN DAT DE GEGEVENS INTACT ZIJN.

DE MAXIMALE AANSPRAKELIJKHEID VAN CANON ELECTRONICS INC. ONDER DEZE GARANTIE IS BEPERKT TOT DE AANSCHAFPRIJS VAN HET PRODUCT WAAR DEZE GARANTIE BETREKKING OP HEEFT.

# R40 Kurulum Kılavuzu

## 1.ADIM Aksesuarların Kontrol Edilmesi



- Kurulum Diski dahil değildir.
- Bu kılavuzdaki öğeler, bildirimde bulunulmadan değiştirilebilir.
- Makinenin ambalajını ve ambalaj malzemelerini, makinenin depolanması ya da taşınması için saklamanız gereklidir.
- Elektrik fişinin biçimi, ülkelere ve bölgelere göre değişir.

Tarayıcıyı kutudan çıkarın ve koruyucu tabakaları (▼) tarayıcıdan çıkarın.

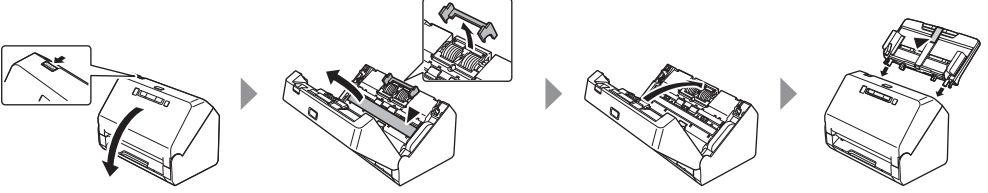

## 2.ADIM Yazılımın Kurulması

Yazılım güncellemelerine ilişkin bilgiler için Canon web sitesine bakın.

### ! ÖNEMLİ

- Tarayıcıyı USB kabloyla bilgisayara bağlamadan önce yazılımı kurun.
- Windows'ta Yönetici olarak oturum açın.
- Yazılımları yüklemeye başlamadan önce diğer tüm uygulamaları kapatın.

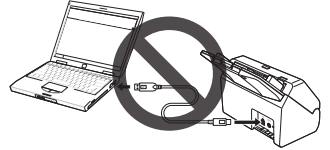

### 1 Yazılımı indirin.



<https://software.canon-elec.co.jp/ims/r40>

### 2 İndirilen yazılımı yürütün ve ekrandaki talimatları izleyin.

Kurulum tamamlandı.

## Belgeyi yerleřtirin

### İpucu

- Uzun belgeleri yerleřtirirken, besleme uzatma desteđini 1 aın.
- Gerekirse belge ıkıř durdurucusunu 2 n kenara dakin.

1

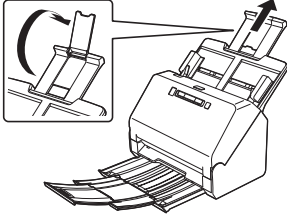

2

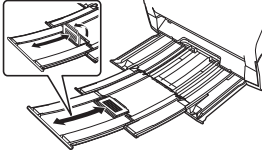

1 Belge kılavuzlarını, belgenin geniřliđine uyacak řekilde ayarlayın.

2 Belgeyi yerleřtirin.

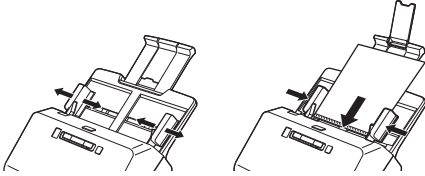

### İpucu

- Belgeleri yz ařađı bakacak řekilde ve st kenarı ilk nce girecek řekilde yerleřtirin.

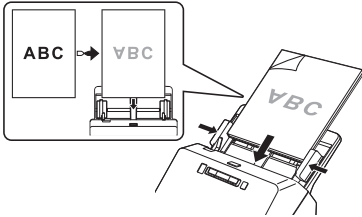

- Bir kartı tararken yz ařađı bakacak ve uzun kenarı ilk nce girecek řekilde yerleřtirin. Ayrıntılar iin Kullanıcı Kılavuzuna bařvurun.

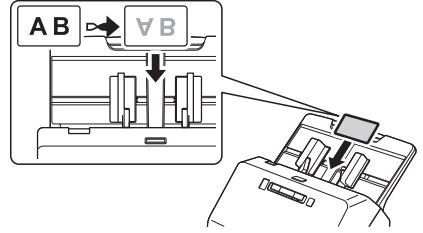

## CaptureOnTouch ile Tarama

1 [Tek taraflı tarama] veya [ift taraflı tarama] gesine tıklayın.



Tarama ayarı  kullanılarak deđiřtirilebilir.

Ayrıca [Yeni kısayol] seeneđini kullanarak kendi ayar dđmenizi oluřturabilirsiniz.

2 Taranan grnty kontrol edin ve [Bitir] dđmesine tıklayın.



Grntleri kontrol edin, silin ve dzenleyin.

Kullanım ayrıntıları iin ekranın sađ st křesindeki 2 simgesine tıklayın.

## 2 CaptureOnTouch ile diğer tarama yöntemi

### Standart Tarama

- 1 Belge Türünü seçin.
- 2 Hedefi seçin.
- 3 [TARA] düğmesine tıklayın.



#### İpucu

- Ayrıntılar için CaptureOnTouch Yardımına başvurun.

### Windows

- ☰ simgesine tıklayın ve Yardımı açmak için menüden [Yardım] öğesini seçin.

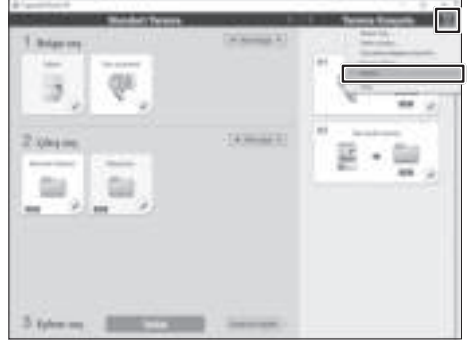

### Mac

- Menü çubuğunda [Yardım] öğesine tıklayın ve [CaptureOnTouch Yardım] öğesini seçin.



### Başlat Düğmesi ile Tarama

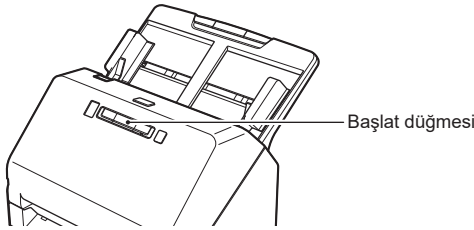

Sık kullanılan ayarları, tarayıcının üzerindeki numaralı bir düğmeye atanabilecek Tarama Kısayolu panelleri olarak kaydedebilirsiniz. Bu, kullanıcının cihaz üzerindeki Başlat düğmesine basarak bir tarama başlatmasına olanak sağlar. Belgeyi yerleştirirseniz İş Seçme düğmesini kullanarak bir İş No. seçin ve Başlat düğmesine basın, CaptureOnTouch başlayacak ve belge taranacaktır.

Ayar yöntemi:

[Tarama Kısayolu] öğesinde bir panel seçin ardından ⇒  ⇒ [Seçenek] ⇒ [Düğme atama:] öğesine tıklayın

### Destek TWAIN Arabirimi

- TWAIN uygulamasıyla uyumludur.
- Ayrıntılar için TWAIN uygulaması kılavuzuna başvurun.

## Yardım

### ■ Kullanıcı Kılavuzu

Windows : [Başlangıç] - [Canon R40] - Kullanıcı Kılavuzu  
Mac : [Uygulamalar] - [R40 User Manual]

### ■ CaptureOnTouch Yardımı

Windows : Görev çubuğunda CaptureOnTouch simgesine tıklayın ve menüden [Yardım] öğesini seçin.  
Mac : CaptureOnTouch'ın ana ekranı görüntülenirken [Yardım] menüsünden [CaptureOnTouch Yardımı] öğesine tıklayın.

### ■ Tarayıcı Sürücüsü Yardımı

TWAIN uyumlu bir uygulamadan tarayıcı sürücüsünü açın ve [Yardım] düğmesine tıklayın.

### ■ Teknik destek

[https://www.canon-europe.com/support/consumer\\_products/contact\\_support/](https://www.canon-europe.com/support/consumer_products/contact_support/)

### ■ Readiris/Cardiris ile ilgili soru

İnternette : <https://support.irislink.com>  
e-Posta ile : [helpdesk@irislink.com](mailto:helpdesk@irislink.com)

## Ticari Markalar

- Canon ve Canon logosu, Amerika Birleşik Devletleri'nde Canon Inc.'nin tescilli ticari markalarıdır ve diğer ülkelerde de ticari markalar ya da tescilli ticari markalar olabilir.
- imageFORMULA, CANON ELECTRONICS INC.'nin bir ticari markasıdır.
- Microsoft, Windows, PowerPoint ve SharePoint, Amerika Birleşik Devletleri'nde ve diğer ülkelerde Microsoft Corporation'ın tescilli ticari markaları ya da ticari markalarıdır.
- Microsoft ürün ekran resmi (resimleri), Microsoft Corporation'ın izni ile yayınlanmıştır.
- macOS, Apple Inc.'in A.B.D.'de ve diğer ülkelerde tescilli bir ticari markasıdır.
- Burada yer alan diğer ürün ve şirket isimleri, ilgili sahiplerinin ticari markaları olabilir. Bununla birlikte, bu belge™ ve © sembolleri kullanılmamıştır.

## Telif Hakkı

Telif Hakkı 2021, CANON ELECTRONICS INC. Tüm hakları saklıdır.

Bu yayının hiç bir bölümü, CANON ELECTRONICS INC.'nin önceden yazılı izni olmadan, fotokopi ya da kayıt dahil elektronik ya da mekanik hiç bir şekilde ya da hiç bir yolla ya da herhangi bir bilgi saklama ya da geri alma sistemi yoluyla çoğaltılamaz ya da iletilemez.

## Sorumluluk Reddi

Bu belgedeki bilgiler, bildirimde bulunulmadan değiştirilebilir.

CANON ELECTRONICS INC., BU MATERYAL İLE İLGİLİ OLARAK PAZARLANABİLİRLİK, TİCARİ ELVERİŞLİLİK, BELİRLİ BİR KULLANIM AMACINA UYGUNLUK YA DA İHLAL ETMEME İLE İLGİLİ GARANTİLER DAHİL ANCAK BUNLARLA SINIRLI OLMAMAK KAYDIYLA, BURADA SUNULANLAR DIŞINDA SARIH YA DA ZİMNİ HİÇ BİR GARANTİ VERMEMEKTEDİR. CANON ELECTRONICS INC., BU MATERYALİN KULLANIMINDAN DOĞAN DOĞRUDAN, ARIZİ YA DA DOLAYLI HER TÜRLÜ HASAR YA DA KAYIP YA DA GİDERLERDEN SORUMLU TUTULAMAZ.

CANON ELECTRONICS INC., BU ÜRÜN İLE TARANAN BELGELERİN SAKLANMASI VE KULLANIMINDAN YA DA TARANMIŞ RESİM VERİLERİNİN SAKLANMASINDAN VE KULLANIMINDAN SORUMLU DEĞİLDİR. TARANAN BELGELERİN ASILLARINI ATMAYI PLANLIYORSANIZ, TARANMIŞ RESİMLERİN İNCELENMESİNDEN VE VERİLERİN EKSIKSİZ OLDUĞUNUN DOĞRULANMASINDAN MÜŞTERİ OLARAK SİZ SORUMLUSUNUZ. CANON ELECTRONICS INC.'NİN BU GARANTİ ALTINDAKİ AZAMI YÜKÜMLÜLÜĞÜ, GARANTİNİN KAPSADIĞI ÜRÜNÜN SATIŞ FİYATI İLE SINIRLIDIR.





**CANON ELECTRONICS INC.**

3-5-10 SHIBAKOEN, MINATO-KU, TOKYO 105-0011, JAPAN

**CANON U.S.A. INC.**

ONE CANON PARK, MELVILLE, NY 11747, U.S.A.

**CANON CANADA INC.**

8000 MISSISSAUGA ROAD, BRAMPTON, ONTARIO L6Y 5Z7, CANADA

**CANON EUROPA N.V.**

BOVENKERKERWEG 59, 1185 XB AMSTELVEEN, THE NETHERLANDS

**CANON AUSTRALIA PTY. LTD.**

BUILDING A, THE PARK ESTATE, 5 TALAVERA ROAD, MACQUARIE PARK, NSW 2113, AUSTRALIA

**CANON SINGAPORE PTE. LTD.**

1 FUSIONOPOLIS PLACE, #14-10, GALAXIS, SINGAPORE 138522

**CANON KOREA BUSINESS SOLUTIONS INC.**

BS TOWER, 607 TEHERAN-RO, GANGNAM-GU, SEOUL, KOREA

**CANON INDIA PVT. LTD**

7TH FLOOR, TOWER B DLF CYBER TERRACES DLF PHASE III GURGAON - 122002 HARYANA, INDIA