

Tab MiniC

BOOX
UserManual

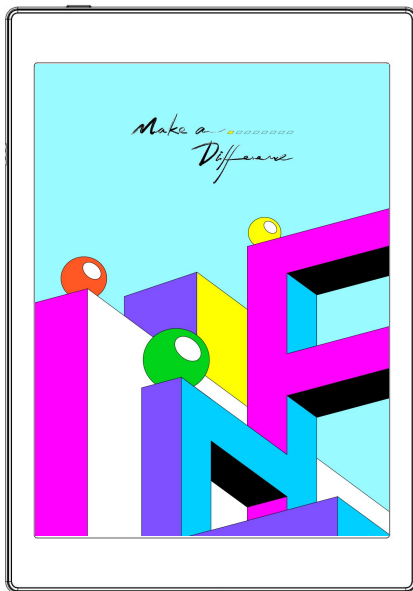

Contents

1. Copyright Declaration	3
2. Product Details	4
3. Safety Guide	6
4. Quick Start	9
5. System Functions	26
6. ONYX APPS	34
7. System Settings	109
8. Thank you for your support	125

1. Copyright Declaration

Guangzhou Onyx International Inc. reserves the right to make changes to the product specifications and contents contained in the Quick Start Guide and User Manual without prior notice.

1. All book images in this manual are for display only, not pre-installed books;
2. Due to different software versions, some functions or interfaces may be inconsistent with the description in the manual. It is subject to the final product.

2.Product Details

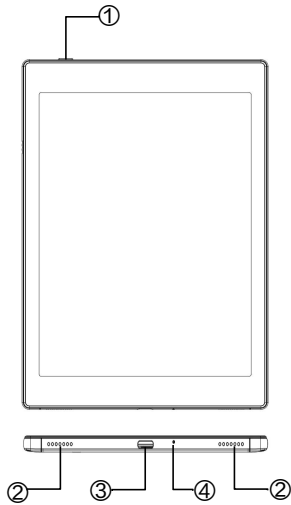

- ① Power
- ② Speaker
- ③ Type-C Port
- ④ Mic

Product Specifications

Operating System	Android 11
CPU	Octa-core 2.0GHz
ROM	4GB LPDDR4X
Storage	128GB
Screen Size	7.8 Inches
Resolution	1404*1872
Touch	Electromagnetic and Capacitive Touch
Frontlight	Dual-color Frontlight
Wireless	WiFi (2.4G+5G) Bluetooth (5.0)
Battery	5000 mAh
Dimensions	194x136.5x8.3mm
Weight	≤265g
Ports	Type-C(Support OTG)
Others	Mic, speaker, G-sensor
Operating Temperature	0° C- 50° C

3.Safety Guide

Please read the following safety instructions before use. If you encounter any technical difficulties, please contact your BOOX retailer, or call the official after-sales hotline at 4008-400-014 or 4008-860-830 for assistance.



Fragile Screen Protection

The E-ink screen is very fragile. Please do not directly hit, squeeze, oppress the screen, or drop it from a high place onto a hard surface. If the display screen is broken, please stop using it and contact our customer service or other qualified professionals for replacement. Do not disassemble and replace it by yourself.



Qualified Accessories

Only batteries, chargers and other accessories that meet the safety standards of this equipment are allowed to be used. For details, please refer to the product specifications.

Use of incompatible accessories will result in damage to the device at your own risk.



Keep away from strong magnets\static electricity

Please keep away from strong magnetic and electrostatic environment to avoid abnormal writing on the electromagnetic screen or damage to other electronic parts.



Keep away from liquids

This device is not waterproof. Do not expose it to a humid environment or use it in the rain. Please keep it away from any corrosive liquids.



Do not dismantle the device

The battery of this device cannot be replaced. Please do not disassemble it by yourself to avoid damage to the structure or screen.



Using environment

The environment temperature range of using this device is 0° C–50° C. Please do not use it continuously in high temperature or low temperature environment.

We are not responsible for the damage or loss of data in the equipment caused by human abnormal operation or unexpected circumstances, nor for other indirect losses caused thereby.

If you need to return to the factory for repair, please back up important data by yourself. We are not responsible for data loss caused by repairing or replacing parts or updating the system.

4.Quick Start

4.1 Power On

Press and hold the power button for 2–3 seconds. When the indicator lights up, it goes into the startup interface. Wait until it goes into the Home Screen.

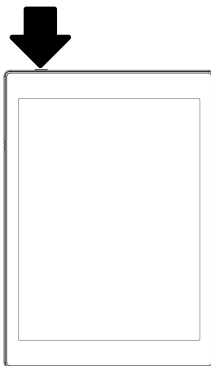

Note: If you cannot turn the device on, please charge it for 20 minutes first, then restart.

Initial Setup

Please follow steps to complete the initial setup, including System language, Power, Navigation Bar Settings, etc. The initial setup can be changed later in Settings.

4.2 Home Screen

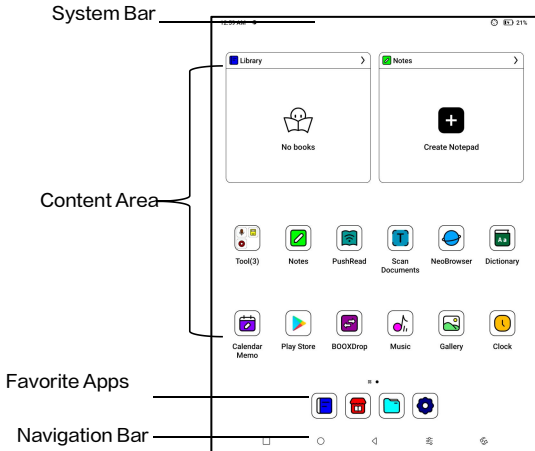

System Bar

The area displays the current status of the device, including Time, Notifications, Refresh Mode, Wi-Fi, battery status, etc.

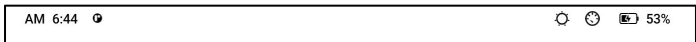

Control Center

Pull it down from the right top edge or tap to expand.

Tap the “Edit” icon on the top to edit the functions for the center.

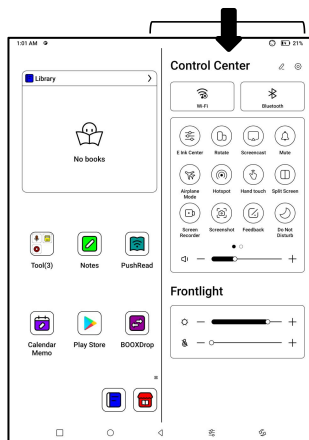

Notification Center

Pull it down from the left top edge or tap to expand.

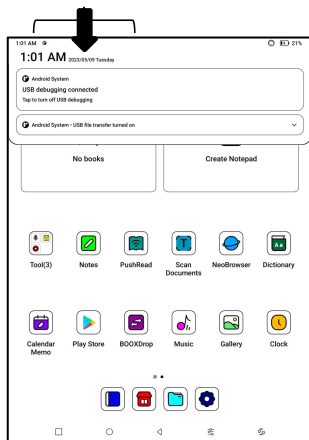

Content Area

Tap and hold an app to move it around on the screen, uninstall it, optimize it, add it to a group, or access some quick functions supported by the app.

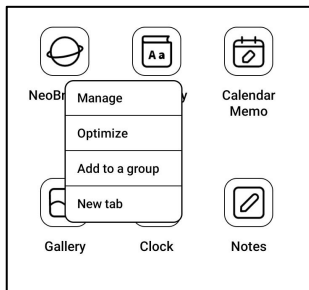

Tap and hold a widget to move it around, remove it, or resize it (The widget is required to support different sizes)

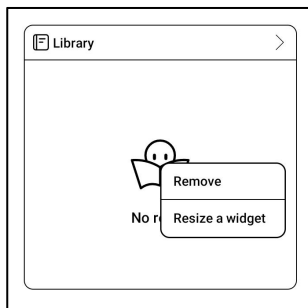

Tap and hold a blank area for 2 seconds to enter desktop editing status. Tidy up apps on the screen, add widgets to desktop, and manage desktop settings.

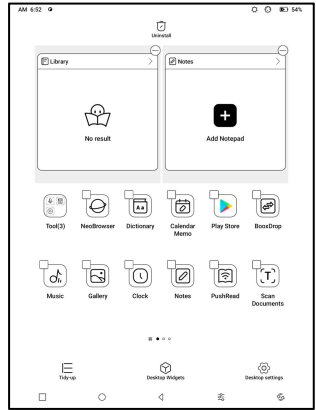

Add Desktops

After the current desktop is full, a second desktop will be automatically added when a new app is installed. You can also long press and drag any icon to the next page manually.

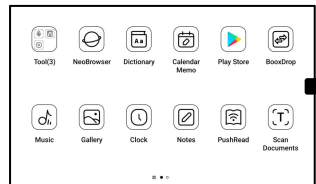

Favorite Apps

Long press an app to drag, add, and remove. Up to 6 apps can be added.



Navigation Bar (Default)

Four combination options available. You can choose your preferred option.



C1: Back / Home Screen /

Multitask / E Ink Centre/ Full Refresh

C2: Multitask / Home Screen / Back / E Ink Centre / Full

Refresh

Gestures

Go to Settings/ System Navigation to change to navigate by Gestures.

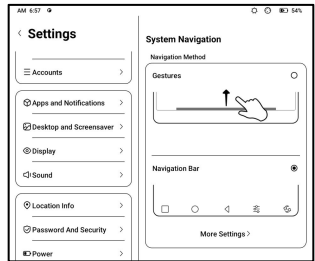

Customize Gestures

Bottom (Default:)

Multitask, Home Screen, E ink Centre

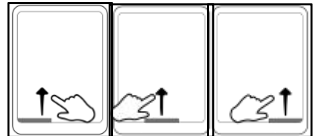

Sides (Default): Back

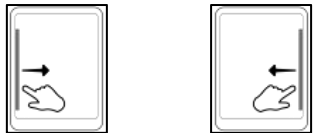

Customize the gestures to your own preferences.

Other Gestures

Swipe down with 3 fingers to take a screenshot. This gesture is enabled by default. You can go to Settings / System Settings / Screenshots to disable it.

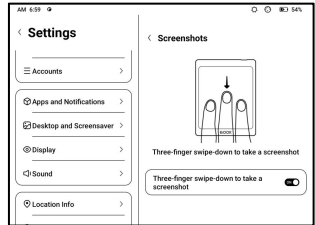

4.3 E-ink Center (App Optimization)

It can be called from the Control Centre or swiping up from the bottom.

This function is mainly used to optimize the display effect of third-party apps .

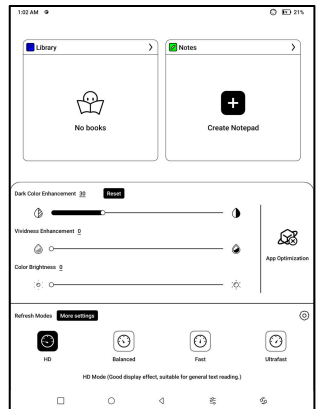

Refresh Modes

You can preset different refresh modes for different apps, or change later.

HD: Good display effect, suitable for general text reading.

Balanced: Heavier ghosting, suitable for quickly skimming through images and text.

Fast: Heavy detail loss, suitable for browsing webpages.

Ultrafast: Heavier detail loss, suitable for playing videos.

Dark Color Enhancement

This function turns darker colors to black and is generally used for enhancing foreground colors, or

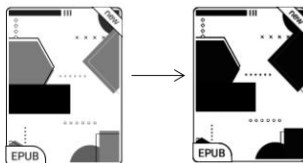

light-colored pages, such as colorful icons, and low-quality scanned PDFs.

Light Color Filter

This function turns light page colors to white and is normally used to whiten the background colors.

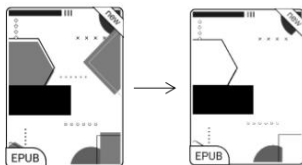

More Settings

Customize more optimization settings for a better user experience by going to E Ink Center/ App Optimization or long-press an app' s icon to choose “ Optimize” .

Display

DPI: Adjust the overall interface size and its default value is 350.

If some apps (such as Kobo) are adjusted to the minimum value and the edges are still cut off, please switch back to the original DPI value of the apps.

Anti-aliasing: Make the text edge sharper

Cloud Optimization: Some apps have been optimized for better performance. Obtain the optimization with just one click after connecting to the internet.

Reset All: All optimization settings will be reset.

Optimization Switch: The main switch. After it is turned off, some optimization effects will be canceled, but the configuration will not be reset.

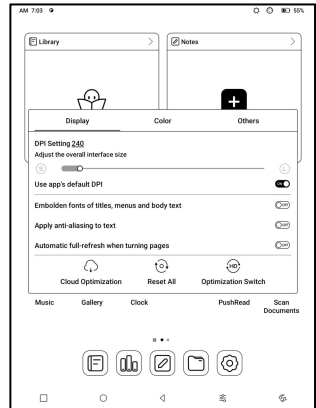

Color

Add strokes to text

Some text may be invisible due to the background bleach.

Add strokes to text can make the text visible again.

Recommended value: 1.

Background Color

This is to bleach a large area of the background color. It is recommended to use this setting together with text enhancement and Icon Colors. Otherwise, the text and small icons on the background will not be visible.

Icon Color

Generally, this is to darken the colors of some small colorful icons in the menu.

Cover Color

Generally, this is to darken the colors of large cover-style icons.

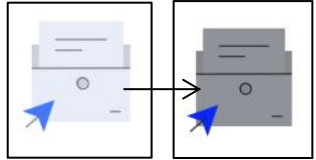

Webpage Text Size

This is for the embedded WebView interface. When the DPI adjustment is invalid, you can try to adjust the font size of the webpage

Webpage Text Color

When bleaching does not work, you can try to adjust the webpage colors.

Embolden Webpage Text

When some fonts cannot be emboldened, you can try to embolden the webpage text.

Others

Keep apps active in the background

This is for the apps that are continuously running in the background, such as Alarms, Notifications, Download. You can stop the apps running.

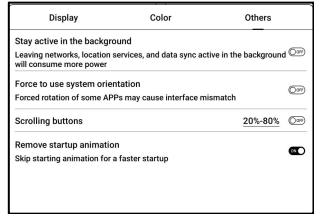

Force follow system direction

Some APPs lock the direction. When the system rotates, if the APP cannot follow the rotation, forced rotation can be used;

Forced rotation may cause some interfaces to fail to display normally, which is related to the design of APP. For such APP, it is recommended to turn off forced rotation and use the original direction;

Scrolling Button Setting

You can go to the Scrolling Button Setting page from App Management (Tap the Menu bar on the upper right corner on the Apps homepage) or Navigation Ball settings.

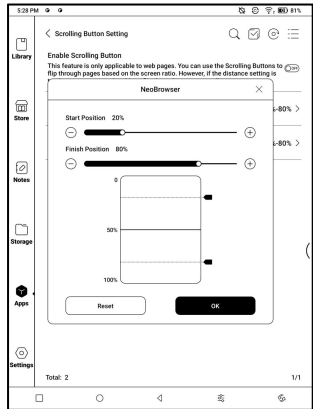

When enabled in third-party apps, the Scrolling Buttons can be used to turn pages. Based on the actual situation of the page, you can set the required starting and ending positions to avoid inconsistent or partially duplicated content after turning a page. It is recommended to set the starting and ending positions between 15% and 90% of the screen. A range that is too large may make it difficult to turn pages effectively while a range that is too small may result in excessive repeated content.

Scribble (Only support some apps)

This setting is only applied to apps with handwriting functions and is to optimize the handwriting speed. Currently it only supports apps including OneNote, Evernote, and WPS.

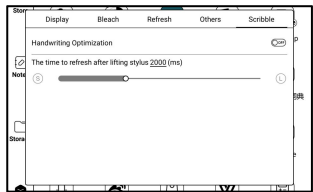

Refresh time after lifting stylus:

The time to refresh after lifting stylus: The handwriting will be refreshed in a set time after you stop writing. The refresh applies to the app's settings such as types, width, and pressure sensitivity.

When refreshing handwriting is in progress, you cannot continue writing. You can continue writing after the refreshing is done.

When refreshing handwriting, you cannot continue writing, please continue to write after refreshing;

If you want less interruption by the refreshing, you can set the refreshing frequency longer.

Hand touch may cause interruption to handwriting. You are recommended to disable hand touch to reduce accidental touch on the canvas to cause problems.

5. System Functions

5.1 Screen Cast

5.1.1 This feature supports Windows 10 or above. It does not support Win 7/XP and MacBook.

5.1.2 Please make sure your computer supports the Screen Cast function. You can check it in the computer system: System / Projecting to this PC

Please be aware that there are 4 settings that will affect the results of searching the computer on your BOOX and the confirmation of connection request.

The computer supports
Screen Cast

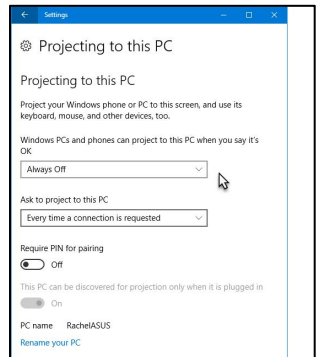

The computer does not support
Miracast /Screen Cast

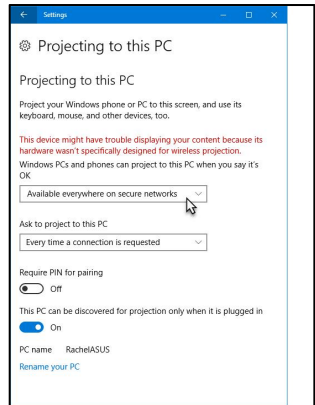

5.1.3 Please make sure that your computer and BOOX are connected to the same wireless network.

If your desktop computer connects Wi-Fi via Wireless Network Card, please check whether the step2 is supported.

Some computer configuration and wireless network cards do not support this function.

5.1.4 On your BOOX, select Screen Cast from drop-down Control Center. Then the automatic search will start. The

computer name will be shown when found.

5.1.5 Select the found computer in the search window. If there are multiple computers, select the computer that you want to project to from the list.

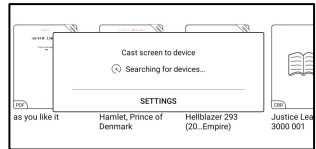

5.1.6 After you select the computer that you want to project to, your computer will pop up a notice to ask whether to accept the projecting request.

5.1.7 After you accept it, your BOOX and computer will automatically connect to each other. And the Screen Cast is successful.

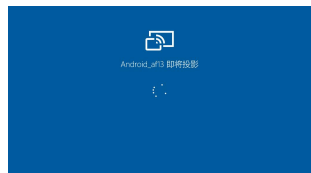

If the "Unable to view protected content on this device" appears on the screen, the connection may be unsuccessful. Please disconnect the device, and request the Screen Cast connection again.



5.1.8 When your BOOX and computer are connected, please tap Screen Cast again from Control Center, then select “Disconnect” . Your computer cannot disconnect the connection.

If your computer support Screen Cast but cannot receive the request, please restart your computer and try to connect again. Please also check whether your computer's setting is to reject the request. (See Step2).

5.2 Screen Recording

Long press Screen Recording icon to go to screen recording settings. You can customize Resolution, Recording Quality, Screen Orientation, Audio Source, Recording Framerate, etc.

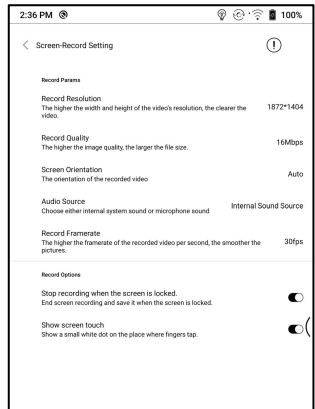

If you use Screen Recording for the first time, you are recommended to adjust the relevant settings first.

Tap Screen Recording icon to enter recording widget. Tap the Start icon to start recording and tap the Close icon to stop recording.

After recording is done, there will be a thumbnail enabling you to play or share the recorded video.

Tap and hold the recording widget to drag it around. The recording widget will not be recorded into the video.

After the Screen Recording is enabled, the recording widget will be floating on the screen all the time. You can create different recordings. Tap X to close it completely.

The recording format is MP4. The save path is
Storage/Movies/Captures

5.3 Split Screen

When an app is open, choose Split Screen from Control Center to initiate the function. The Split Screen supports docs, Notes, and other apps. The Split Screen cannot be initiated from system interface.

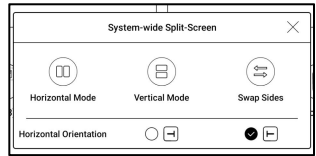

Note: Whether an app support Split Screen is subject to the app itself. If the app does not support Split Screen, please get in touch with the developer.

In Split-Screen mode, the newly opened app is the secondary screen. You can choose to swap sides and exit the Split Screen mode.

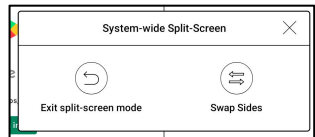

In Split-Screen mode, only the app on the main screen support Refresh settings and the refresh setting does not take effect on the secondary screen.

In Split-Screen, Display settings take effects on both apps.

6. ONYX APPS

6.1 Library

The Library only shows the supported formats. Cover Mode is used by default. All eBooks are sorted by Time Created.

On the upper right corner of the Library, you can search books, create bookshelves, manage books in bulk, check Reading

Statistics, filter and sort, switch between Cover and List modes, scan book covers, manage sync and Library settings.

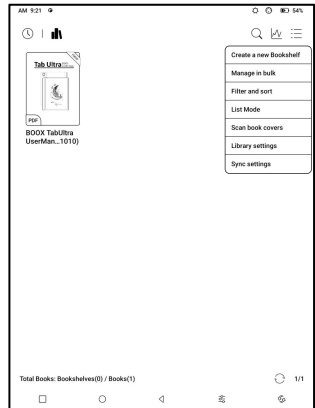

Library Mode

By default, the Library is in Scan Mode, which automatically scans all supported files under specified saving paths. Tap the icon to switch to Directory Mode which displays all supporting documents according to the directory structure in the Storage.

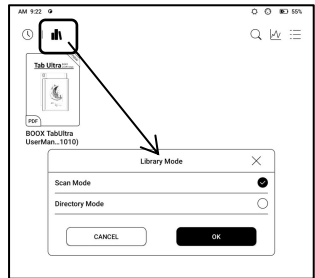

Filter and sort

Apply to all eBooks by default and sort by the recent reading time in descending order;

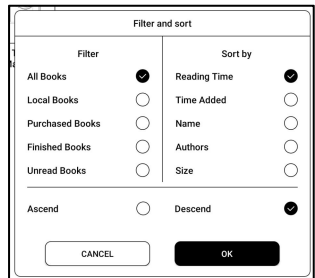

Library Settings

You can choose to display title instead of file name, enable/disable reading statistics, or choose scan path.

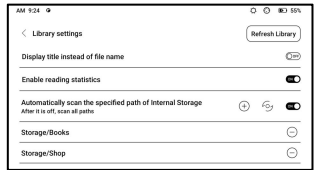

The default scan path is: Books and shop in Storage. You can customize the scan path and choose to auto-scan the specified path.

Note: In the following case, some documents will be removed from the Library after the Library is refreshed. You can check the source files from the saving path.

1. Documents opened directly from other non-scanning path in Storage.
2. Documents that are not in the default scan path after the default scan path is modified.

Sync settings

You can sync reading progress and data across devices via Onyx Cloud. The feature is on by default. If you do not want to sync

your reading data of all documents, you can turn this feature off.

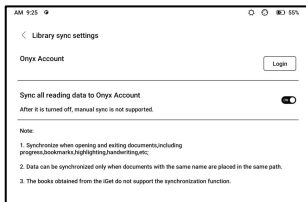

If you do not want to sync the reading data of some documents, long press their book covers to go to Sync Settings, and turn their sync off individually.

Note: Currently, only reading data can be synced to the Cloud. The source document cannot be synced to the Cloud. You need to add documents to the same path on different devices for the sync.

Cloud Storage

After binding a third-party Cloud Storage, you can download documents from the Cloud Storage to your device, but uploading documents from your device to the Cloud Storage is currently not supported.

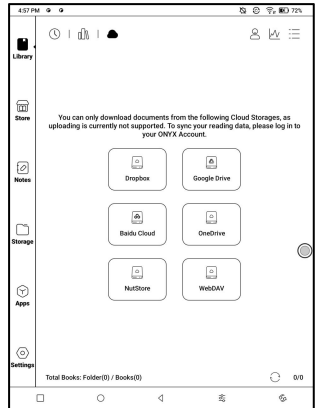

After embedding data to PDF documents, you can upload the PDF documents back to the original folder in the Cloud Storage. Other formats currently do not support this feature.

To sync reading data, please log in to your ONYX Account.

Cloud Storage Settings

PDF documents can be automatically uploaded after you exit the documents. The upload speed is limited by the network speed and Cloud Storage speed limit. It is not recommended to upload larger documents frequently. Instead, you can manually upload them when needed by long-pressing the cover and selecting manual upload.

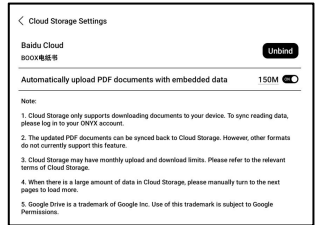

After logging into the Cloud Storage, you can set the automatic upload size of PDF documents in the Cloud Storage Settings, with a default size of 150MB and a maximum size of 300 MB.

Some Cloud Storage may have monthly quota limits. If you encounter errors such as being unable to download or

upload, please check for network issues first, then confirm with the Cloud Storage providers whether they have a limit quota.

Book Property

Long press a book cover to check book-related information, including title, author, format, size, reading progress, book details, Open with, Lock, Rename, Move, Custom Cover, Delete and Share.

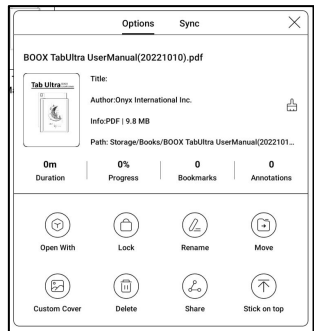

Saving path: tap the saving path to jump to the actual saving location.

Clear settings

You can clear password, reading data, cache, and book cover.

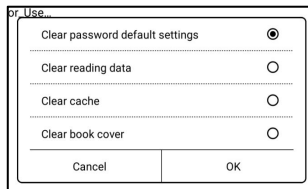

Clear password default settings

Only clear the default settings of locked documents or documents with their own passwords, and will not clear the relevant passwords.

Clear reading data

All personal data of the selected book will be cleared. The data cannot be recovered after being cleared.

Please perform this action carefully!

Lock

Add locks to documents (reading passwords) to protect personal reading data. The password is used to open books in NeoReader. When the documents are exported or copied to other devices or other apps, the password will not be valid anymore.

The screenshot shows a dialog box titled "Add Password". It features three radio button options: "Use Fingerprint Password" (which is selected), "Use Numeric Password", and "Use this Password Setting by default" (which has a checked checkbox). Below these options are two text input fields: "Please Enter Password: Please enter a 4 to 8 digit" and "Confirm Password: Please enter the Password again". A notice at the bottom of the dialog reads: "Notice: The Password cannot be reset without login of Onyx Account (Mobile or E-Mail)". At the very bottom, there are two buttons: "Cancel" and "OK".

The digital password only supports setting one password. After setting the digital password for the first time, you do not need to set it again if you use the digital password for other documents. You only need to add locks to other documents.

The reading password cannot be retrieved. If you forget your reading password, you can only reset the password through Onyx Account (only Mobile phone and Email login

methods supported).

If you use this password by default, you can add password directly to other documents after setting it for the first time. In this case, you do not need choose to add locks every time.

Reading Statistics

This summarizes your personal reading statistics, including Today's Reading Time, Read Books, Finished Books, Total Reading Time, Marks and Annotations.

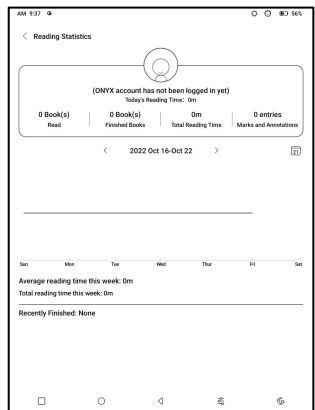

Average reading time this week is based on 7 days and calculates the average daily reading time within this week.

Tap Marks and Annotations to jump to My Annotations page and tap any book under Recently Finished Books to open the book.

If you do not want to use reading statistics, you can turn it off from Library Settings. After it is off, the reading statistics icon in the Library will not show anymore

6.2 NeoReader

Tap the center of the screen to bring up the reading menu. You can switch between multiple documents, and select related functions.

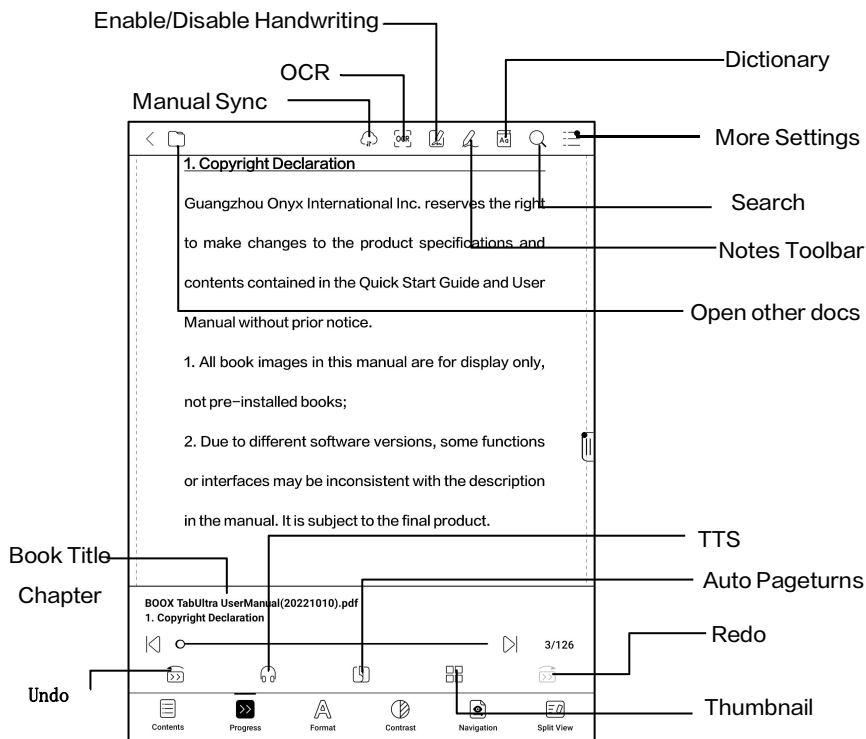

Floating Toolbar

By default, the Floating Toolbar is collapsed to the right edge.

When it is expanded, long press the Toolbar to drag it to anywhere you want on the screen. It can be collapsed to the sides to avoid covering text during reading. When needed, swipe left or right from the screen edges to call it out.

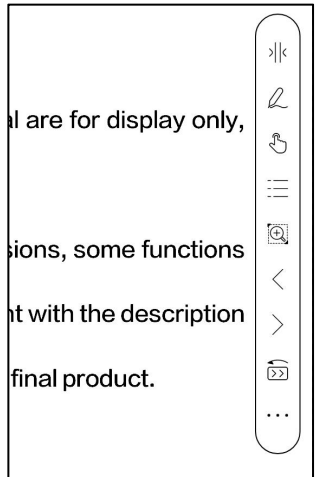

When using zooming and columns in PDF, automatically add the Panning icon and Reset icon(both are off by default) to help you manage the zoomed-in document.

When a page is divided into several columns, single tap to turn each column and tap the Virtual Buttons to turn the whole page

Long press to select a word

Long press a word to call out the dictionary dialog box. You can switch between different dictionaries. Select the one you want from the dropdown list.

This function requires you to install dictionaries. If you haven't installed a dictionary, you cannot look for words. Tap any area outside of the dictionary dialog box to exit it.

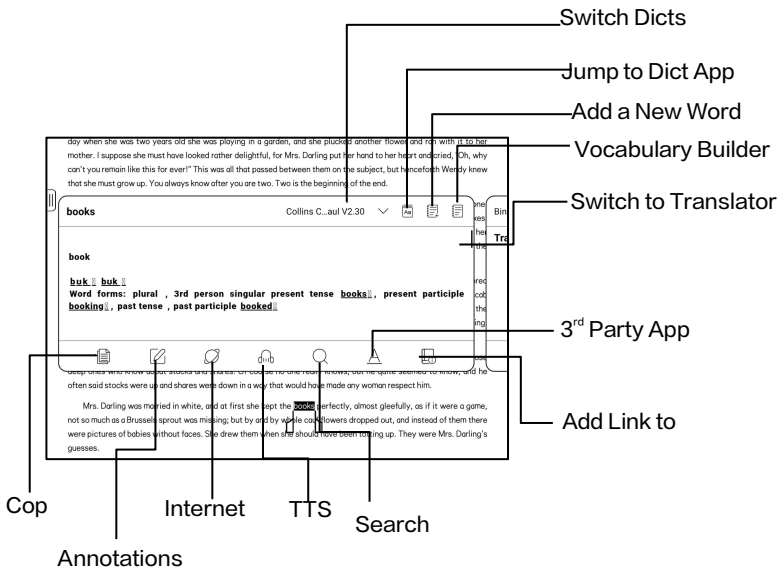

OCR (Beta Version)

Only support images on formats including PDF、CBR、CBZ、DJVU、PNG

Recognize one page at a time.

Selecting the right layout (horizontal or vertical layout) can improve recognition accuracy. After recognition, long press any text to add marks or look up dictionaries.

If some recognized text is not accurate, you can correct the text in the annotation dialog box (This does not change the original text in the image)

Check all recognized pages from Contents/Bookmarks where you can quickly locate and jump to the relevant pages. Tap the OCR icon on the upper right corner to clear OCR content.

Handwriting Toolbar

The handwriting Toolbar is floating on the screen. Long press it to drag it around. Handwriting status is by default.

You can disable and enable it from the reading menu on the top. Bring out Handwriting Toolbar from the Floating Toolbar. You can collapse it.

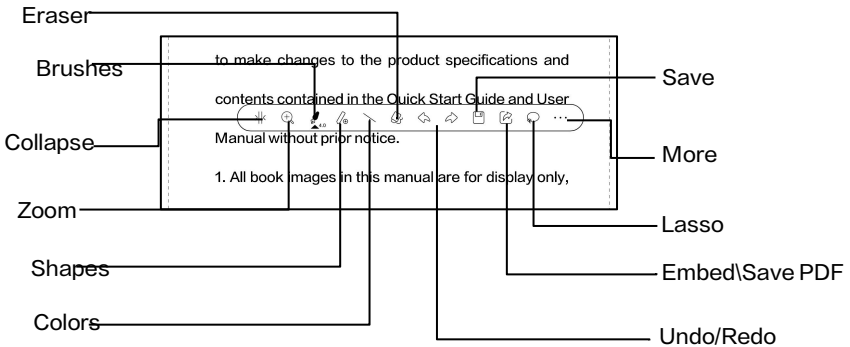

Embedded PDF data

The handwritten notes in PDF will be embedded into original documents when you exit a

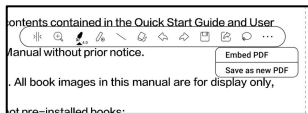

document. You can open, view, and edit them with other apps such as Adobe Acrobat, WPS, and Chrome on your PC. You can copy to other BOOX devices to view and edit as well.

Embed PDF: You can embed handwritten notes into original documents from the Handwriting Toolbar when you are still in a document.

Save as new PDF: a new PDF document will be exported and keep the same handwritten notes.

Non-PDF documents do not support embedding data. You can only check and edit the relevant data on your BOOX. Changing the document name will not impact the existing data.

PDF documents with embedded data

1. Changing document name, copying, or moving saving location will not impact recognizing PDF embedded data
2. When you use other apps to open the document on a PC, it will be split into multiple documents. New documents are different documents and will not import embedded data.
3. When you use other apps to open the document on a PC, it will be recognized as a different document after being edited and saved. And the embedded data will not be imported.
4. When you merge multiple PDF documents into one, the new document will be a different one and will not import embedded data.
5. If you use handwriting when your BOOX is connected to the PC, it is recommended to disconnect the USB, save the PDF, and then connect the USB again to open it from the PC in order to ensure the normal data update.

PDF Documents without embedded data

When a new PDF document is opened, the system will automatically detect and import the existing local data by the document ID and saving path.

For example, if you delete document 123.pdf with embedded data from local storage, and then put the original 123.pdf document without data back, the following scenarios may exist:

1. When save it in the same path as the previous document, the embedded data will be automatically imported.
2. When you save it in a different path, the embedded data will not be imported.
3. When you change the name of the original document and even save it in the same path, the embedded data will not be imported.
4. If you change another document to 123.pdf and save

the document in the same path, the embedded data will not be imported.

Handwriting Recognition

It is off by default. You can go to Settings – Handwriting Recognition Setting to enable it.

For handwritten notes and drawn shapes, double-tap onto the handwriting, which will be converted to printed text and standard shapes.

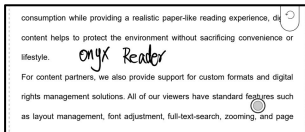

The handwritten notes and drawn shapes within 0.5cm and straight lines within 0.3cm will be deemed one recognition content area. Distance further than above will be deemed different recognition content areas.

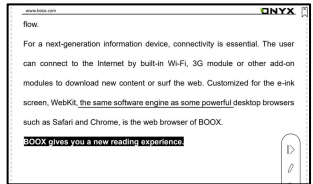
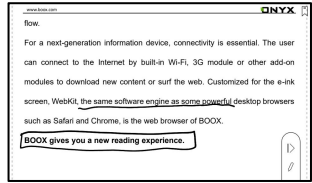

Tap lower left and right corners on the screen to turn pages

When palm rejection is enabled, you can enable this feature from Settings/ Handwriting Recognition Setting. After it is enabled, you can turn pages by tapping the lower left and right corners using your stylus.

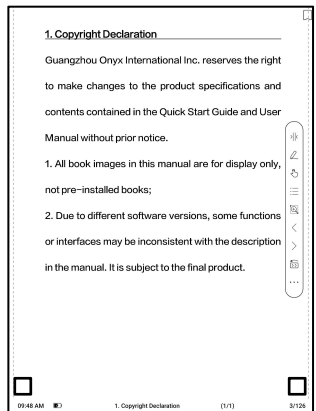

Reading Menu at the bottom (PDF)

The menu includes Contents, Progress, Format, Contrast, Navigation, and Split View

Contents

This section includes TOC, Bookmarks, Annotations, and Handwriting.

TOC supports a 3-level structure. The current page is underlined in the TOC. Tap each content to jump to the corresponding page. Tap any area outside of the Contents interface to exit.

1. Copyright Declaration	3
2. Product Details	4
3. Safety Guide	6
▶ 4. Quick Start	9
▶ 5. System Functions	25
▶ 6. ONYX APPS	33
▶ 7. System Settings	109
8. Thank you for your support	126

Navigation bar: TOC, Bookmarks, Annotations, Handwriting, 1/1, 3/129

Bookmarks

When reading a book, you can tap the Bookmark icon on the upper right corner to bookmark the current page. Tap the icon again if you want to un-bookmark the page.

Check all bookmarks at Contents/Bookmark. Tap each bookmark to jump to the corresponding page. You can also delete bookmarks here.

Annotations

All highlighted, underlined, and annotated contents are shown in Contents/Annotations. You can check, edit, and delete all relevant content here.

After selecting the text, you can choose colors to highlight and underline. This feature is more suitable for color E Ink models.

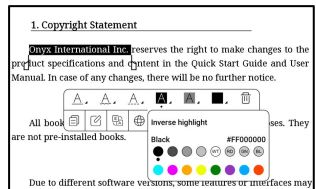

Black and white models cannot distinguish colors, but the colorful highlights and underlines can display their original colors when exported to other devices.

Some darker colors may cover text completely. Please select suitable colors for highlights.

Tap each content to jump to the corresponding page. All contents under Annotations can be exported in txt format. The default saving path for the exported contents is Storage/ note/ a file with the same name as the original document. You can also export the contents to a third-party notes app. Go to System Settings/Accounts to bind third-party apps(Currently Dropbox is supported).

Handwriting

All pages with handwritten notes are shown in Contents/Handwriting. You can check and delete the relevant pages. Tap each page thumbnail icon to jump to the corresponding page. All pages with handwritten notes can be exported in PNG images. The default saving path for the exported contents is Storage/ note/ a file with the same name as the original document.

Progress

Here it shows a chapter name of the current document (if no chapter name, the document name will be shown), progressing page number, Previous/Next chapter, page number, Automatic Page–turns, Redo and Undo, etc.

Tap the page number to pop out the Jump–to–page dialog box. Enter the page number that you want so as to jump to the

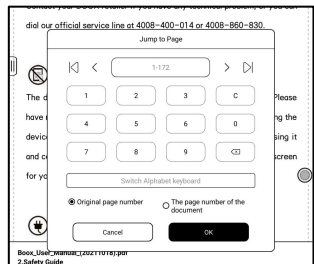

relevant page.

You can search the built-in page numbers of PDF documents. (The custom page numbers)

Format

Page Display: switch between single-page mode, dual-page mode 1, and dual-page mode 2.

The dual-page mode only supports a landscape screen.

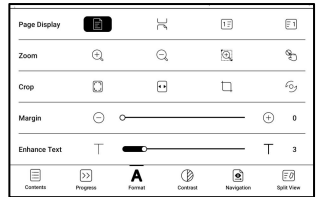

Zoom: You can zoom in/out the whole page, zoom in the marquee area, or pinch-to-zoom any area you want.

Crop: Tap relevant functions to automatically crop all blank areas, or blank areas only on the left and right, or the marquee area.

Margin: This is for the margin you want to keep for automatic crop. You can adjust it to the size you want.

In zoom-in status, when the zoomed-in page exceeds the screen area, you can drag the page around to check different areas. A single tap only turns sub-pages. Tap the Virtual Buttons to turn the whole page.

Contrast

Embolden: only embolden text
in PDF

Sharpen Img: Make blur image
sharper

Watermark Bleaching: Bleach the light-color images or
background on the page

Dark Color Enhancement: Adjust for the whole page or only

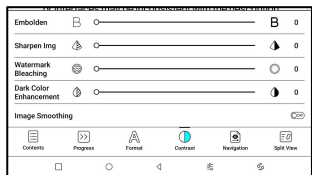

the text, making the display darker;

Image Smoothing: Optimize the display effect of pictures with gradient colors;

Navigation

This section includes Comic Mode, Article Mode, Reflow, and more custom settings. You can crop a scanned PDF, divide it into columns, and set its browsing orders.

Navigation / More

Crop: You can manually crop the blank margin in either single-page or dual-page modes.

Columns: Divide the current doc into different columns

Direction: Set the reading order of the divided columns

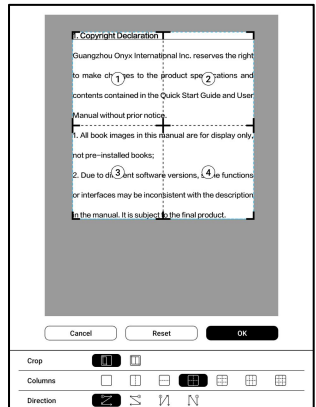

Reflow

Only apply to

PDF\DJVU\CBR\CBZ in

scanned version and

text-based version.

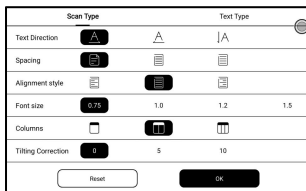

Reflow scanned documents

You can adjust Text Direction,

Spacing, Alignment, Font Size,

Columns, Tilting Correction.

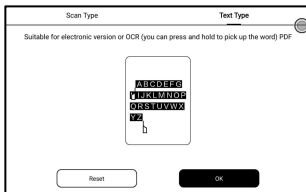

Reflow text-based documents

Apply to digital or OCRed PDF. After being reflowed, the

document can use flow-document functions.

Split View

You can choose to split documents vertically or horizontally into two windows.

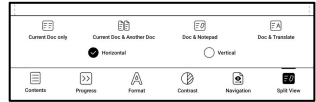

You can swap the sides of the two split windows.

Current Doc Only: Display 2 different pages of the current document at the same time.

Current Doc & Another Doc: Display the current document and another document at the same time.

Doc & Notepad: Display the current document and Notes app at the same time

Doc & Translate: Display the current document and Translate at the same time.

Reading Menu at the bottom (Free Flow Documents)

The menu includes Contents, Progress, Format, Contrast, and Split View and supports free-flow formats such as EPUB\TXT\MOBI\AZW3

V2 Engine

Some free-flow formats such as

ePub\Mobi\azw3\txt\word\jeb\html use V2 Engine by default. You can go to reading Settings / Other settings to change to NeoReader.

V2 Engine supports the original layout of the document, including font, line spacing, margin, graphic typesetting, indentation, etc. When being switched to V2 Engine, the document will be closed automatically. Next time when you open the document again, V2 Engine will be used. If you want to switch to NeoReader, you can disable V2 Engine and reopen the document.

Progress

The document needs to be paginated again after switched to V2 engine or font and spacing adjusted. You can check the pagination progress in the reading Menu/Progress. After the progress bar is loaded, it means the pagination is completed. You can drag the progress bar or jump to another page after the pagination is completed.

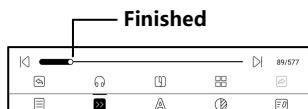
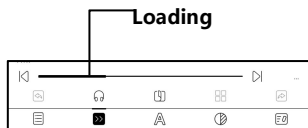

Format

Fonts: You can import your own fonts to use. Save your fonts to Storage/fonts. When you open a document, the fonts will be detected. The settings such as font size, typeface, contrast,

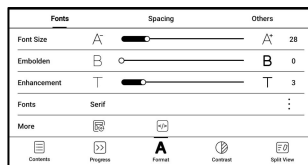

bold, spacing only work on the newly opened documents but do not work on the documents opened before the settings.

If you want to restore the original format of the document, you can tap the Restore Original Format icon.

Screenshot

Tap the two corners (shown in the pic) on the screen at the same time to take a screenshot (PNG format). This function is only available on the reading page.

The screenshot can be saved to local storage, shared by scanning QR code and other means. The local saving path is Storage\Screenshots

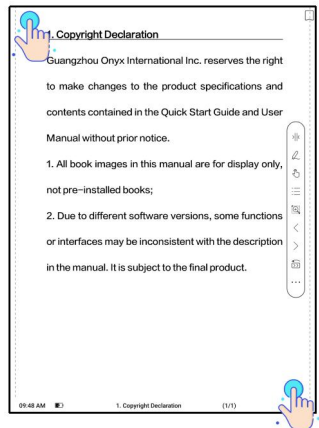

Refresh

Tap the hamburger menu on the upper right corner to choose Refresh settings.

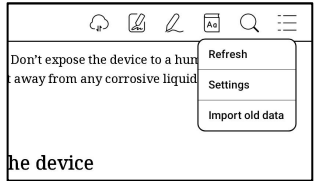

When you drag a page, speed mode is used by default.

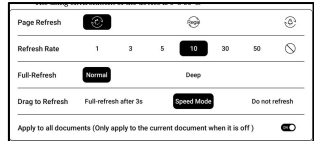

Deep full-refresh is recommended for documents with a lot of images and darker background to reduce ghosting during reading.

Settings

Tap the hamburger menu on the upper right corner to go to reading-related settings such as Global Settings, PDF Settings, Touch Settings, TTS Settings, Export Settings, Screenshot Settings, Floating Toolbar Settings, Handwriting Recognition Setting, Other Settings, and Version Number.

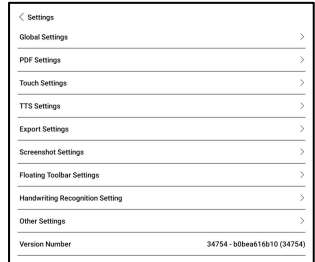

Dictionary Settings

When looking up words in the Dictionary, ONYX Dictionary and ONYX Translate are used by default.

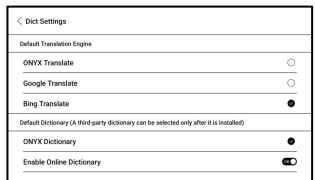

You can select another Translate or third-party Dictionary app as the default choice (Third-party apps require installation first).

If you choose a third-party dictionary, the word lookup interface will use the third-party dictionary interface instead. You cannot use other features provided by ONYX's word lookup function.

Online Dictionary

When the device is connected to the internet, you can directly use Online Dictionary directly to look up words.

You can use it without installing local dictionary files, and it currently supports Chinese and English.

Different network environments will affect the overall speed of word lookup. If the network is consistently poor, you can turn off Online Dictionary in the Dictionary settings and use local dictionaries instead.

RTL (Right to Left) Page-turning Direction

This feature is applicable to some vertically-oriented books and comic books. When the page-turning direction cannot be determined automatically, you can enable the RTL (Right-to-Left) page-turning direction in the reading Settings-More settings.

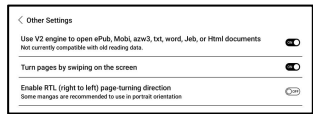

Please note that enabling this mode will enable the RTL page-turning direction for all documents. So please choose to use it according to your actual needs.

6.3 Store

In the language of non-Chinese, the Store is offering free publications E-books from the Internet.

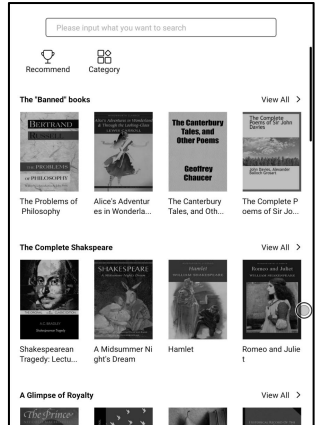

Category

Books can be screened according to different categories.

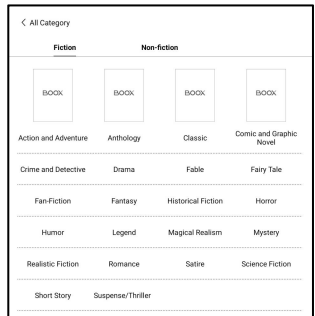

Book Detail

Click a book cover to open up book detail. The specific book information. Click “Full Edition Download” to download the book, then you can see this book cover in Library .

The screenshot shows a book detail page for "The Prince" by Machiavelli, Niccolò. At the top left, there is a back arrow and the text "Book Details". Below this is a book cover for "The Prince" featuring a portrait of a man. To the right of the cover, the title "The Prince" and author "Machiavelli, Niccolò" are displayed. Below the cover and title is a button labeled "Full Edition Download". Underneath the button is the text "Introduction:" followed by a copyright notice "© Copyright". Below the copyright notice is the section "Book Recommendation" with a link to "Another batch". The recommendations are displayed in a grid of book covers with their titles: "Herakleitos", "The American Indians", "Historias de Filipinas e Principes", "Lips Tulian und seine Baude...", "The Glöed Age", "Invaders from the Infinite", "The Last of the Bushrangers... Detective", "Anderson Crow, Detective", "Camilla", and "英荷一役の歴史 (紀伊藩)".

6.4 Notes

This interface includes Recent Notes, Local Notes, and Reading Notes.

Recent Notes: Display 12 recently opened notepads

Local Notes: All notepads created in Notes app

Reading Notes: notes from Split-view in NeoReader

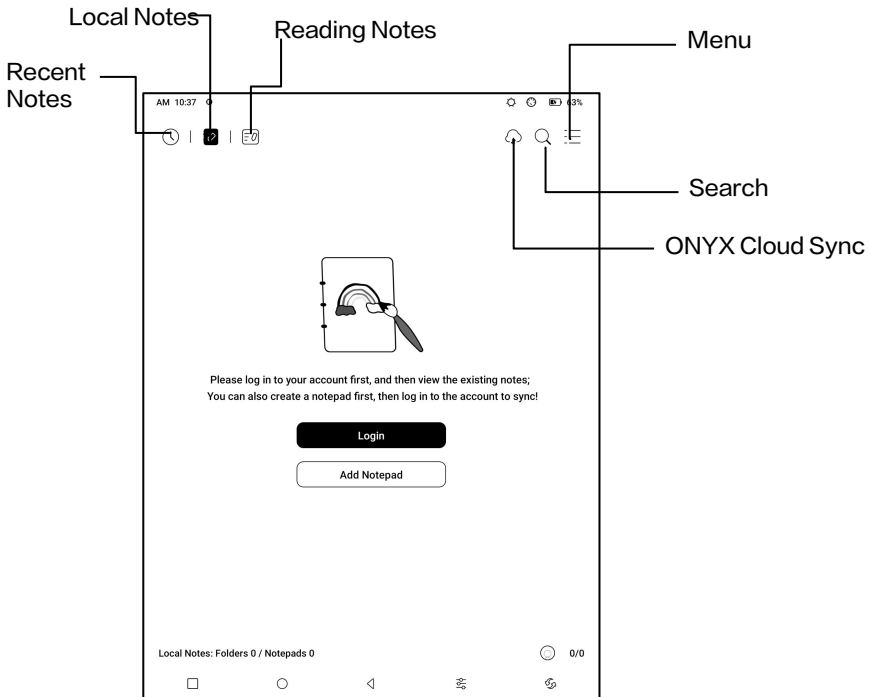

Create Notepad

When creating a new Notepad, you can select Notepad type, modify the notepad name, choose a template, set the scaling method, and whether to apply the template to all pages. You can only create a Notepad after confirming all settings.

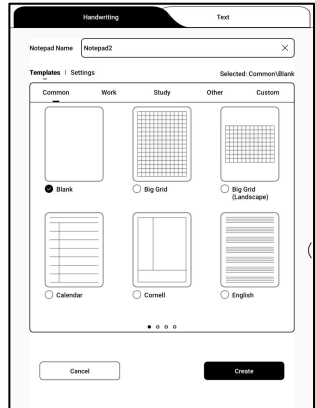

ONYX Cloud Sync (In Bulk)

After Onyx account is logged in, the sync function is on by default.

When you open an existing notepad, notes will be retrieved from the cloud. When you close a notepad, notes will be synced to the cloud. The notepad list and content are synced respectively. It may take longer to sync the notepad content. Please wait and check until the sync is completed.

Check synced notes at BOOX Assistant app or push.boox.com.

Sync individual notepad

Long press a notepad cover to pop out Property dialog box for checking sync status. Tap the Sync icon to resync if there is a sync issue. You can turn off the sync function for individual notepad. You can also turn off the sync function of all notepads from Sync Settings in the menu.

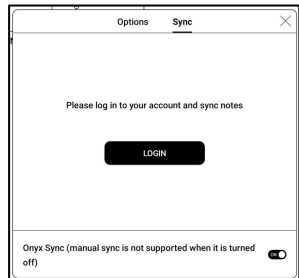

Menu

Here includes Create a Folder, Manage in bulk, Sort by, List Mode/ Cover Mode, Sync Settings, Options, and Recycle Bin.

Sync Settings

ONYX Cloud Sync

After you log in to Onyx account, the notes will be automatically synced to Onyx Cloud when you open and close a notepad.

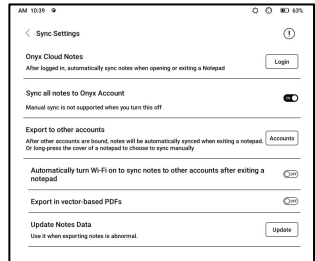

Or you can tap the Sync icon on the Toolbar to manually sync notes. If you do not want the sync function. You can turn it off from Sync Settings.

Sync to other accounts (export)

After you bind a third-party sync app to your BOOX, the notes will be automatically synced to the app when you close a notepad.

The 3rd-party app sync is one-way export. You can export your notes in PDF or PNG to a 3rd-party app, but you cannot sync the notes back to your BOOX. No need to log in to your Onyx account.

Options

This covers general settings for notes, including Stylus Calibration, Backup and Restore, AI Recognition language settings, Password Settings, Show erasing trace...

etc.

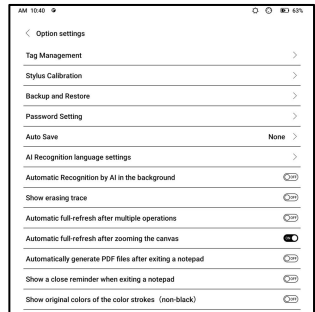

Backup and Restore

You can back up and restore your notes locally. Cloud backup is not supported.

You can restore the backup data, but restoring the backup data will overwrite the current data. Please perform this carefully.

Password Settings

This password is only applicable to notepads in the Notes app.

The password does not follow notepads. Individual notepads cannot have separate passwords.

When a password is set, it is applicable to all notepads. You can remove the password for individual notepads and also lock the notepad with the set password again.

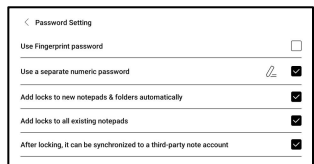

When using a separate numeric password, you can choose to add locks to new notepads automatically. If you untick this option, the newly created notepad will not be locked with the set password. You need to add the lock manually.

When a notepad is protected with a password, its cover does not show a thumbnail view of your notes.

You can long press a notepad cover to pop out Options to add a lock to the notepad or unlock it.

Notepad Interface

When you exit a notepad, your notes will be automatically saved. You can also manually save your notes while you are still taking notes.

Tapping the page number, you can choose to jump to other pages.

You can customize the side Toolbar to your own preference. The toolbar on the top does not support customization.

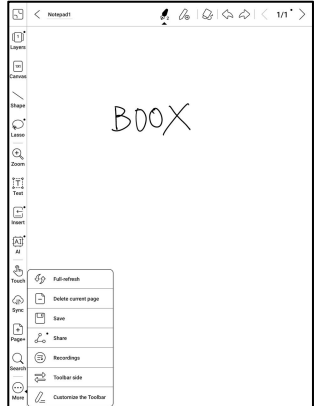

Layers

This supports a template layer and another 5 custom layers. You can hide, lock layers and

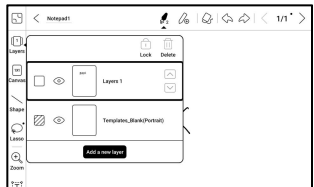

adjust the layer orders. The hidden layers will not be shown in an exported document and will not be recognized by AI Conversion. When a layer is locked, it does not support any editing.

Templates

A template can only be added to the Template layer, which cannot be deleted. Template settings include Scale proportionally, original image splice, stretch to fill screen and original size. You are recommended to start writing after determining which template to use to avoid notes misplace if you change the template after you start writing.

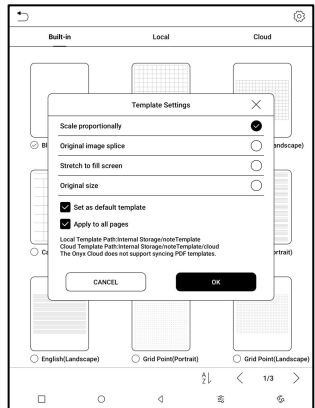

Canvas

The default canvas size is 1x1, the same as the screen size.

You can adjust the canvas size to 1x2, 2x1, or 2x2(max), or customize the canvas size by dragging the canvas.

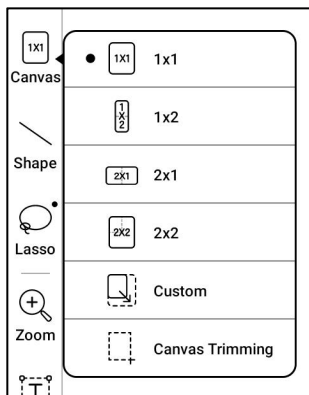

Using the upper left corner as the base, you can extend the canvas by dragging the canvas left or downwards. When you switch from a big canvas to a small canvas, your handwriting outside the canvas area will not be displayed but will be kept.

When you switch to the big canvas, you can see the hidden notes again. Canvas Trimming is to automatically crop the blank part of the canvas by the stroke on the edge of the visible layer.

Fit Canvas and Fit Screen

When the canvas size is larger than 1x1, you can choose Fit screen or Fit canvas under Zoom in the toolbar to view your notes.

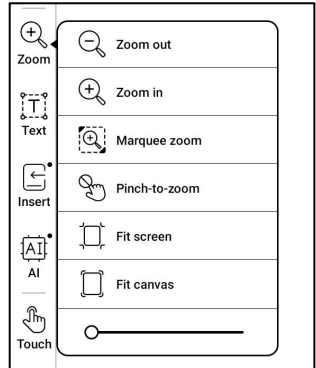

Fit canvas

The canvas will automatically expand to fill the screen.

When it is larger than the screen, you can long-press the canvas and drag it to view hidden notes.

Fit screen

The canvas is zoomed out to fit the whole screen. The grey area is not writable.

Brushes

Support up to 5 pinned brushes. You can preset the types, colors and line width of the pinned brushes. Tap any pinned brush to expand more settings of the brushes.

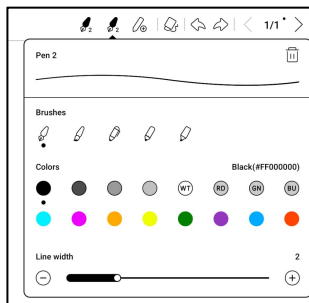

Eraser

When using Mobile Eraser, Stroke Eraser, and Lasso Eraser, you need to switch back to brush to continue writing. When you choose to erase all notes, it automatically switches back to brush.

Lasso

You can use Lasso to select any content in your notepad. After selecting the notes, you want, you can choose to add tags to,

change the colors of, copy, paste, delete, zoom, and move the selected notes.

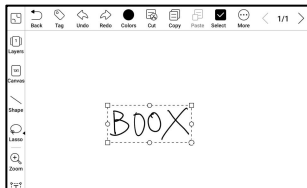

Tags

You can use the Lasso tool to select any notes and add tags, which can add identifiers to the selected notes for search recognition.

Each selected content can be added up to 5 tags. Images, shapes, recordings, and other attachments do not support adding tags.

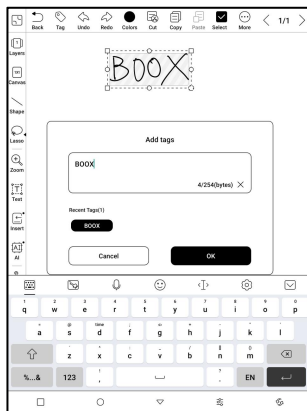

Search tags

The search list shows all tags by default. You can view certain tags by filtering.

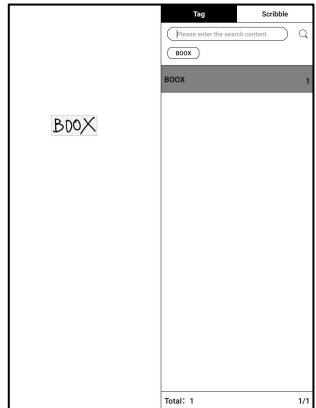

Tag Management

The tag is a global feature and all notepads share the same tags. Go to Options/ Tag Management to check all tags.

When you delete a tag, the corresponding notes will not be deleted.

Insert text

In inserted text mode, you can use keyboard to type. The text box can be moved around. You can change the font size and line spacing, embolden fonts, underline, italicize, and delete text.

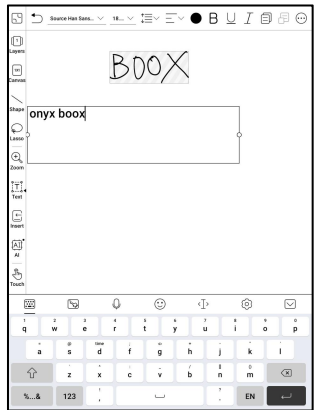

Insert other attachment

You can insert recordings, images, attachments, links to another page within notepad, and links to external websites.

Insert Recorder

During recording or playing a recording, you can add marks .

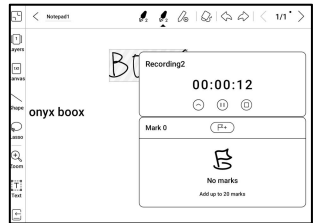

Recording marks

You can add marks to recordings while you are recording. Tap each mark and jump to the corresponding location.

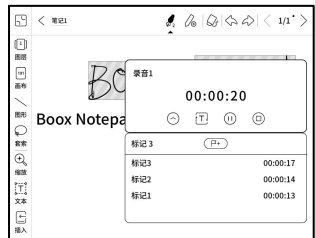

Insert pictures

You can insert local picture, move, zoom and copy the inserted images. Use lasso tool to select an inserted picture and edit it again.

Insert attachments

Insert an attachment up to 20MB. The inserted attachments can be synced to Cloud along with the notepads.

Insert a link to a page

Under Insert icon, you can add links to Notepads, Files, and Websites.

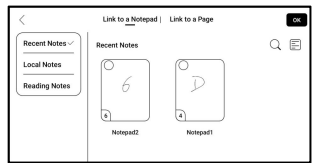

When adding a link to a page, you need to select a notepad or a file first. Only PDF document supports Link to a Page.

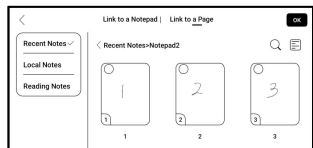

When the link style is set to "Icon only", users need to tap twice to access the linked page – the first tap is to display the link's title, and the second tap is to

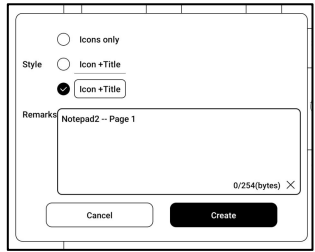

direct to the linked page. This design is intended to prevent accidental tap to access the linked page.

When the link style is set to "Icon + Title", users can simply tap on the rightmost "navigate" icon to access the linked page.

Users can long press the link icon or title to drag and adjust its position on the page. Note that once a link has been added, it cannot be modified. To make changes, you need to delete the old link and add a new one.

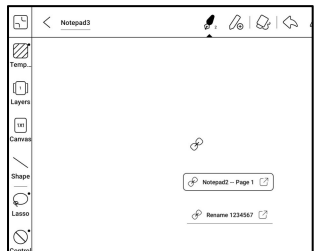

Insert a link to website

You can insert a link to an external website. Tap the link to open corresponding website.

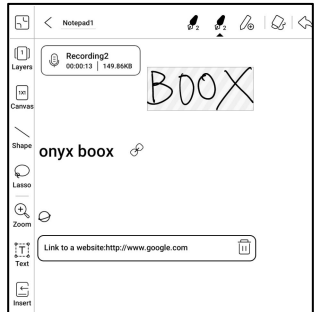

AI Recognition

Convert handwritten notes into text. English and Chinese are available by default. Other languages require language package download.

The converted text can be directly inserted into the current page.

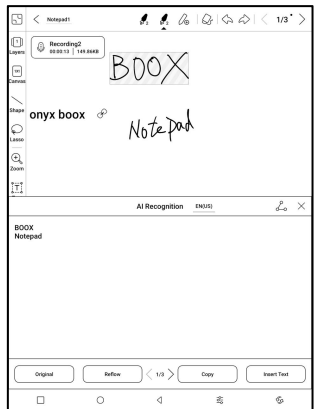

You can choose either original layout or reflow layout to

convert all handwritten notes on the current page.

AI converted content is synced based on the original handwritten content. If handwritten content is changed, the content will be re-converted when you start another conversion.

Control

To avoid interference with handwriting caused by accidental triggering of edge gestures when your palm moves along the edge of the screen during writing, you can disable certain gesture functions in the Toolbar-Control.

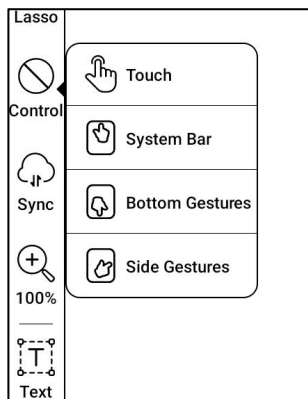

For models with physical buttons, the button function can also be disabled. Please refer to the specification of the

product.

Share and Export

Inside a notepad, you can select specific pages to share or export.

On Notes homepage, you can share the entire notepad by long-pressing its cover. Here you cannot select specific pages to share or export.

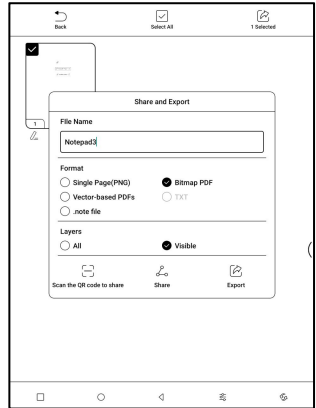

The .note format, which contains the original data of a notepad, can be exported and sent to other BOOX devices. You can continue using and editing the notes after a .note file is imported to another BOOX device.

Import .note notes file

In the Storage, you can tap on a .note file to import it as a new notepad, which can be further edited.

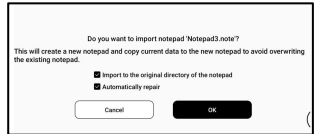

When importing, you can choose whether to keep the original directory of the notepad. It is recommended to choose "Automatically repair" to ensure that the imported data is displayed correctly.

Text Notes

Text Notes supports text input and allows you to adjust formatting, insert recordings, attachments, and perform other operations, but it does not support direct handwriting input using a stylus.

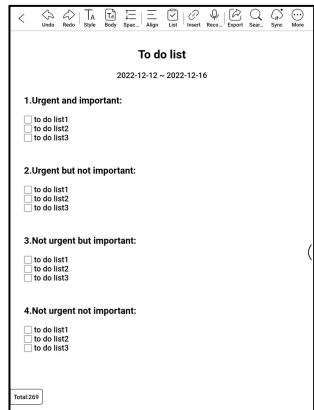

When creating a text notepad, you can choose a template.

Within the notepad, you cannot select or modify the template. If you need to adjust the template, it is recommended to clear the formatting using the "Clear Format" option in More menu, and then manually set the desired style.

A single text notepad supports up to 5000 English words.

Recorder

Each notepad can insert one recording, which is fixed at the top of the notepad.

After finishing a recording, you can continue recording if needed.

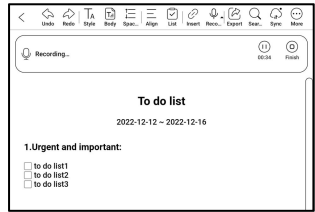

6.5 Storage

Recent Files

Here includes Shortcuts and recent files. The recent files are sorted by time in descending order by default and grouped by date automatically.

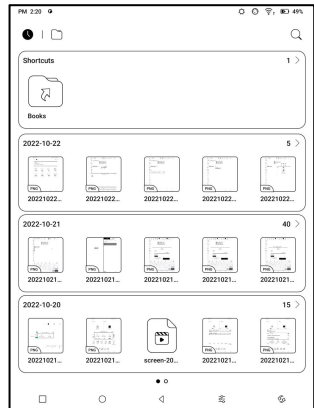

Storage

Here includes the storage path and document categories. All files are sorted automatically into different categories by type, but the files' original storage location does not change.

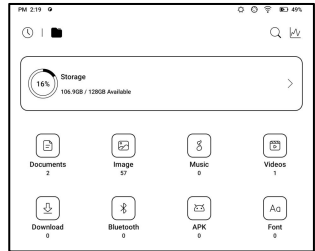

OTG External Flash Drives

This device supports Type-C OTG flash drives. After a flash drive is inserted, the flash drive

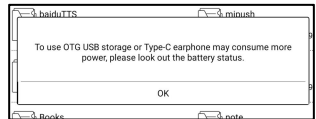

will be automatically recognized and loaded as a storage. OTG devices require a power supply and will increase battery consumption

Low storage warning

Please make sure of leaving at least 300MB of storage for normal system running and relevant data storage. When the storage is lower than 300MB, the system bar will show a warning icon for “insufficient storage” .

6.6 Navigation Ball

Tap the Navigation Ball to expand or contract it. Its default display style is fan-shaped. You can change to other styles (Horizontal Style and Vertical Style) from the settings. You can also set its opacity by percentage. You can pin any buttons which will always show on the top.

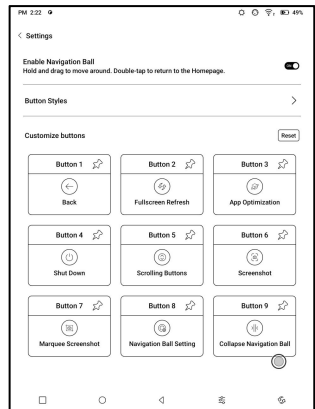

You can customize each button's function. The available functions include some system functions, switching apps, and app optimization.

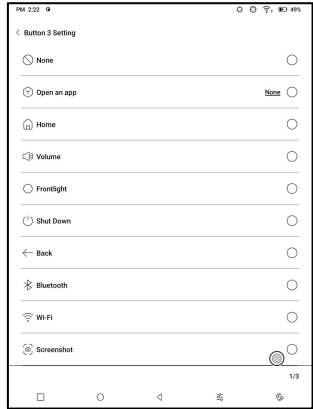

6.7 Dictionaries

When you open Dictionary for the first time and there is no dictionary installed, there will be a notice to lead you to local downloads, which require a Wi-Fi connection. Word pronunciation requires dictionaries with voice files and TTS is currently not supported.

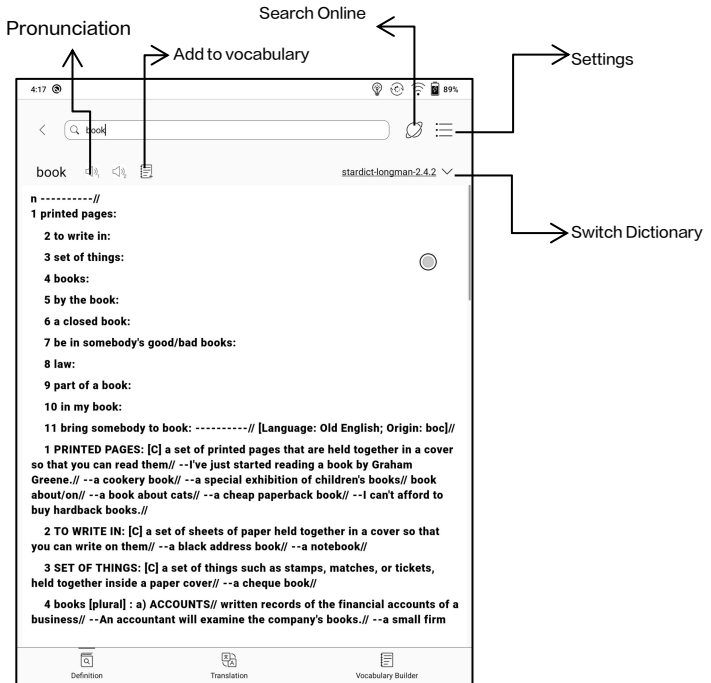

You can import your own dictionary files and save them to the designated storage path: `sdcard\dicts\XXX;`

Each dictionary has a corresponding folder. For example, `dicts\Advanced Chinese Dictionary`

In dictionary Settings/Preferred Dictionary Setting, you can check all available dictionaries. Up to 20 dictionaries are supported.

When there are dictionaries installed, you can search words in the search box. The lookup results are subject to the words included in the dictionary. If you cannot find a word, please change to another dictionary.

You can add found words to Vocabulary Builder to manage in bulk.

6.8 BOOXDrop

Connect your BOOX with a PC or a mobile phone. You can send files to your BOOX from PC or BOOX Assistant app, or saves files of your BOOX to your PC or mobile phone.

How to:

1. Open BooxDrop from Apps page or Control Center.
2. Open a browser on your PC
 - 2.1 No login required: Make sure your BOOX and PC in the same network. Enter the IP address shown on BooxDrop interface to your PC browser to connect.

BooxDrop does not disconnect automatically. If you want to disconnect it, please disconnect it manually or on BooxDrop interface.

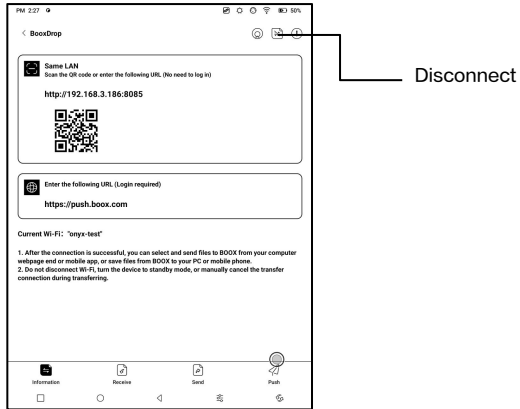

2.2 Log in to Onyx Account: open push.boox.com.

You can see the connected devices and click any device to open.

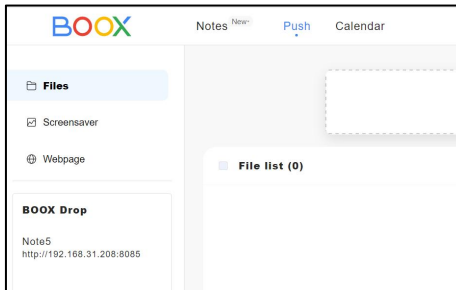

3. When you open a connected device, it will automatically recognize whether your BOOX and your PC are in the same network. If they are not in the same network, you can not open the page.
Please change to the same Wi-Fi.
4. When the connection is successful, you can load all folders and files from your BOOX.
5. Send files to BOOX: You can select files on your PC and send to BOOX. All sent files are grouped into corresponding folders based on file formats.
Recent files: all files are sorted by time and same as Storage/Recent Files
Library: Books/xxx.epub (including all supported file formats)
Image: Pictures/xxx.png
Music: Music/xxxx.mp3
Audios: Movies/xxxx.mp4
Download: Download/xxx.xxx (Including

non-books, pictures, mp3, mp4, etc.)

Storage: Send files to the selected storage.

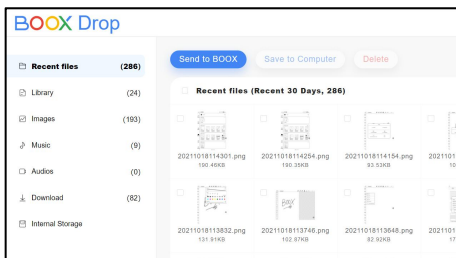

6. Save files to PC: when you select a file from your BOOX on your PC, you can choose a saving path to save to your PC.

Push History

You can only see the Send and Receive history on your BOOX.

6.9 PushRead

Aside from Onyx Push, you can use RSS and OPDS in PushRead

Onyx Push

You can push webpages to your BOOX via Push in push.boox.com or BOOX Assistant, and read on your BOOX. If you use PushRead for the first time, you need to log in to the same Onyx account on both push.boox.com or BOOX Assistant and your BOOX.

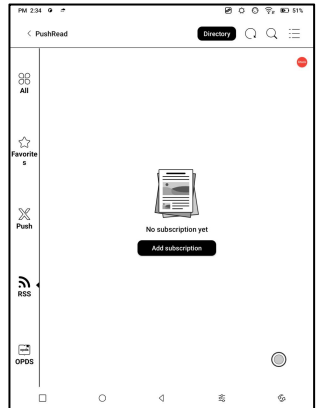

RSS\OPDS Subscription

You can add subscriptions from the public source list. You can also customize your RSS/OPDS subscription. You need to create a group for the first-time adding RSS subscription source so that the subscription source can be added to the relevant group.

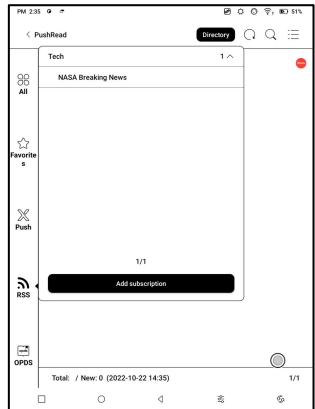

The webpages in PushRead requires internet to load for the first time. After being loaded, it can be read offline.

The default layout is Web Mode (the original webpage' s layout). Tap the center of the screen to bring out the menu where you can switch to Reading Mode, change font size, and fully refresh the screen.

6.10 Calendar Memo

In Calendar Memo, it shows

Today's Notes and Today's

Read. Tap to open notes or

books. You can add memo to

each day and set the memo as

screensaver. Please refer to

Screensaver / Calendar

Screensaver for settings.

Currently, the calendar memos do not support sync to cloud.

After logging in to Onyx account, you can email memos in PDF to a designated email address.

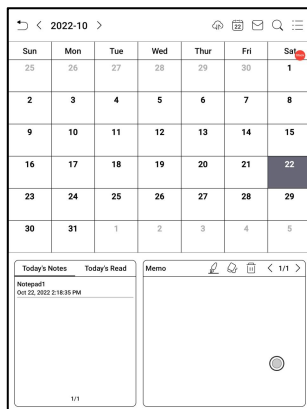

7. System Settings

7.1 Onyx Account

Support multiple accounts and switching between accounts.

You can switch between accounts from the account list.

Only account information is kept

After switching between accounts, you need to log in accounts again. If different

accounts use different servers, the servers will be switched when you log in to another account.

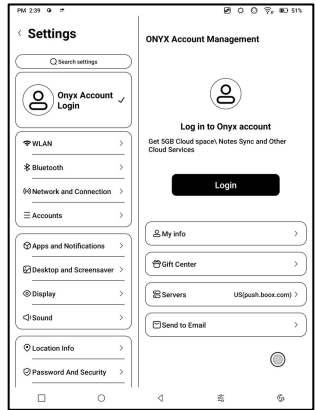

Associated accounts: After you log in to a main account, you can associate the main account with another two login methods. The three login methods share the same account. Mobile phone and E-mail support unbinding and Wechat does not support unbinding.

7.2 WLAN (WLAN)

Wi-Fi Setting

When you turn WLAN on, the device will search all available Wi-Fi. Choose the Wi-Fi you want to use, and enter required information such as password to connect to Wi-Fi. Or turn Wi-Fi on and off from Control Center. Add networks manually by tapping Add Networks.

Bluetooth Settings

Turn Bluetooth on and search nearby available Bluetooth devices. Send connection request. Only when both devices are connected, Bluetooth will work.

Network and Connection

Here includes Flight Mode, Hotspot and Tethering settings, App Data Usage, Screen Cast, Printing, VPN, and Private DNS.

7.3 Accounts

System Account

Here includes Google Account, Email App, etc.

Other Accounts

You can bind and unbind the Cloud Storage accounts under Settings/Accounts (Other Accounts)

If you unbind a Cloud Storage account, downloaded books will no longer be available in the Library. However, you can continue to use them after rebinding the same account.

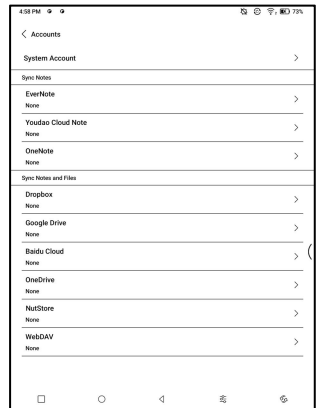

Bind WebDAV

Regarding the binding of WebDAV accounts, please refer to the binding process introduction on the websites of each Cloud Storage. Different Cloud Storage may use different login methods. For example, with NextCloud, you need to apply for an application password on the webpage and use it to authorize login instead of using the account password.

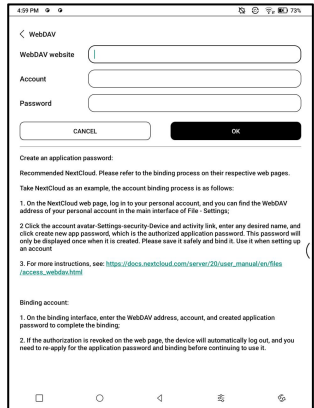

7.4 Apps and Notifications

Here includes Application management, Permission management, Notification management, Default app, App Startup, App Refresh Mode, Store Settings, Freeze Settings, Reset App Optimization Tutorial, and Reset all app optimization.

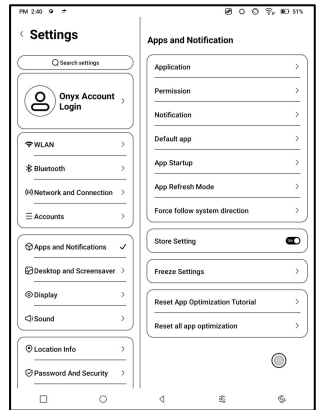

App Startup

Only for auto-starting apps. If enabled, it may increase memory usage and power consumption.

The app itself must have the function of monitoring system to automatically start up. After installing the APK, you need to manually open the app to run it once;

After the startup is successful, it only runs in the background and will not be displayed in the recent running tasks;

App Refresh Mode

You can manage refresh modes of third-party apps in bulk.

Freeze Settings

You can freeze third-party apps here. Freezing apps that are running in the background can reduce power consumption.

Reset App Optimization Tutorial

When you open third-party apps for the first time, an App Optimization tutorial will pop up. If you want to see the tutorial again, please reset the App Optimization Tutorial [here](#).

7.5 Desktop and Screensaver

You can set Home Screen, choose to lock the desktop layout, and enable Smart Assistant. Only one power-off image can be used.

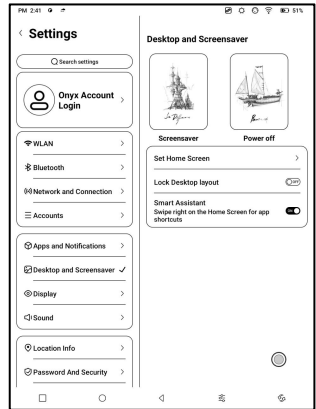

Screensaver

Support Image Screensaver(default), Memo Screensaver, Clock Saver, and Transparent Saver. For Image Screensaver, when you select only one image, the screensaver stays static. When you choose more than one images, the screensaver will play all the images repeatedly.

Power-off Image Setting

You can set Power-off image along with settings including “Show text on power-off screen, Text Position, Image zoom method. (When image ratio is different from screen, the image cannot be used.)

7.6 Display

Text

You can adjust the system font, font size. When you choose largest font, some interface text may be covered due to short of display space.

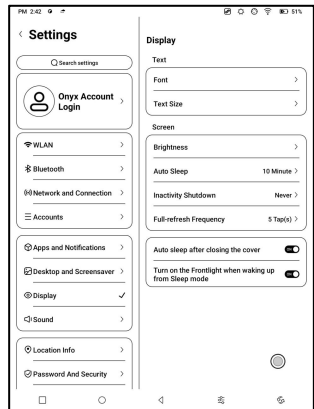

Screen

You can adjust screen brightness, set Auto Sleep and Inactivity Shutdown time, and set full-refresh frequency.

7.7 Sound

You can set volume, ringtone, mute, and Do not disturb.

7.8 Location Info

You can enable “Access my location information” , and “Location Permission.

7.9 Password and Security

Support 6-digit Lock-Screen password,

Android 11 does not support resetting password. Please keep your password safe.

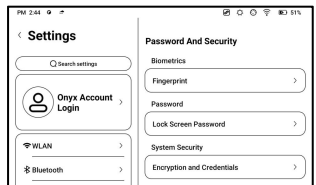

7.10 Power

You can check battery usage and choose whether to delay disconnection after your device goes into sleep mode, whether always to turn Wi-Fi on when the device boots up, and whether always to turn Bluetooth on when the device boots up.

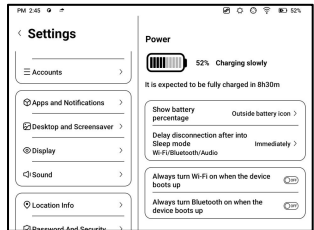

7.11 Storage

You can check the storage usage here.

7.12 System Navigation

You can choose system navigation method, either by Gestures or by Navigation Bar. There are 3 bottom gestures and 2 side gestures for Gesture

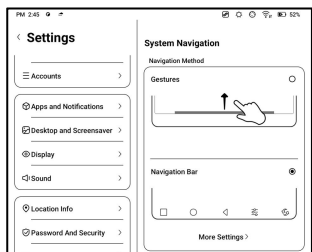

method. There are two combinations of navigation buttons for Navigation Bar.

Side Gestures

The Up-and-down Swipe Gestures are used to adjust Brightness, Volume, etc. by dragging the slider up and down.

The Left-and-right Swipe

Gestures are used to perform custom functions by swiping inward from the sides.

This Gesture may overlap with turning pages by swiping left and right. So, it is recommended to choose suitable gestures based on actual needs to avoid affecting the main gestures use.

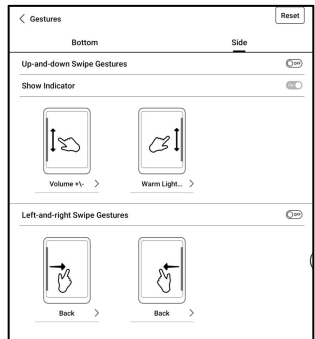

7.13 System Settings

Here includes System Update, Language and Input, Date and Time, Navigation Ball, Screenshots, Screen Recording, Accessibility, Calibration, USB Debug Mode, and Reset Device.

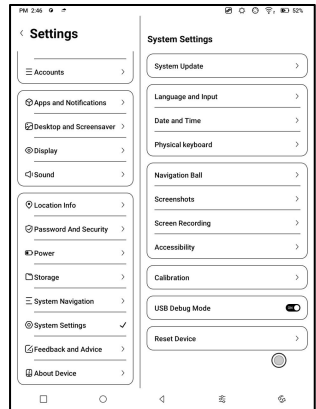

System Update

By default the system will check update package locally first, then check from cloud. If a firmware update is detected, it will be downloaded automatically. Download can be paused in progressing, and resumed later.

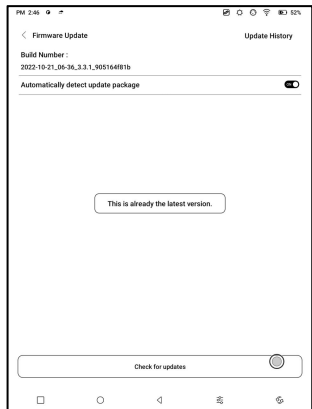

When an update package is downloaded successfully, you need to manually choose whether to update your BOOX.

Before updating, please ensure 20% of battery and enough storage space.

Language and Input

Onyx Input

Support switching between different languages. Please refer to the Keyboard Settings page for the supported languages.

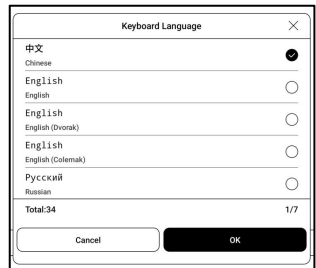

When an external keyboard is connected and the device detects the keyboard, a configuration option for the physical keyboard will appear in



the Notification Centre. Tap the notification to enter the keyboard settings page.

You can change keyboard layout manually for the external keyboard.

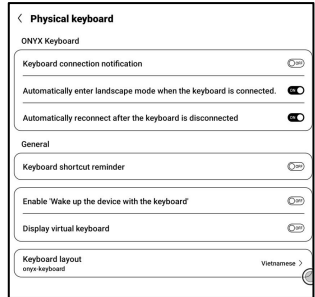

Date and Time

You can choose to set time manually or automatically.

When your device is connected to internet, the system will set time automatically according to internet time.

Note: In order to ensure normal server connection of third-party apps such as Kindle, you are recommended to set time automatically according to internet time.

Reset Device

Note: when resetting device, you will clear all user data.

Please back up your data in advance and operate this carefully.

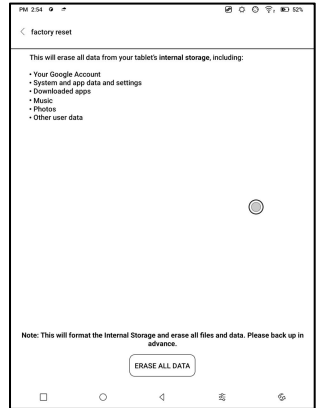

7.14 Feedback and Advice

FAQ

Here contains those frequently asked questions. If you have any questions, you can find the relevant questions here.

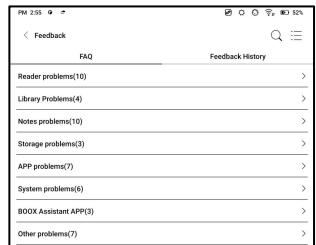

Feedback

You can add attachments such as documents or pictures to your feedback, which will help us quickly locate the problems.

When the device is turned off, the feedback history will be cleared. If you do not want the history cleared out, you can go

to Settings to enable “Save logs to local storage before rebooting the device. This option will collect relevant logs which will help us to evaluate the issues. We will not disclose any relevant information of your device. If you have any doubt, you can untick “Send logs” .

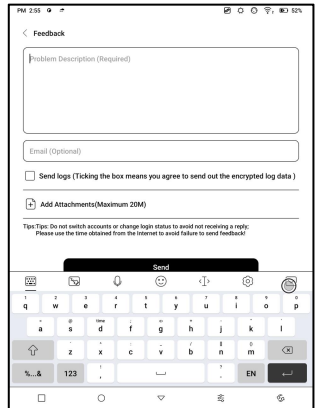

7.15 About Device

This contains device information such as device model and name, firmware version, MAC address, electromagnetic touch version, capacitive touch version, etc.

8. Thank you for your support

Thank you very much for your support. More product-related information can be found on our official website: www.boox.com

If you have any questions, please contact us by email: support@boox.com