

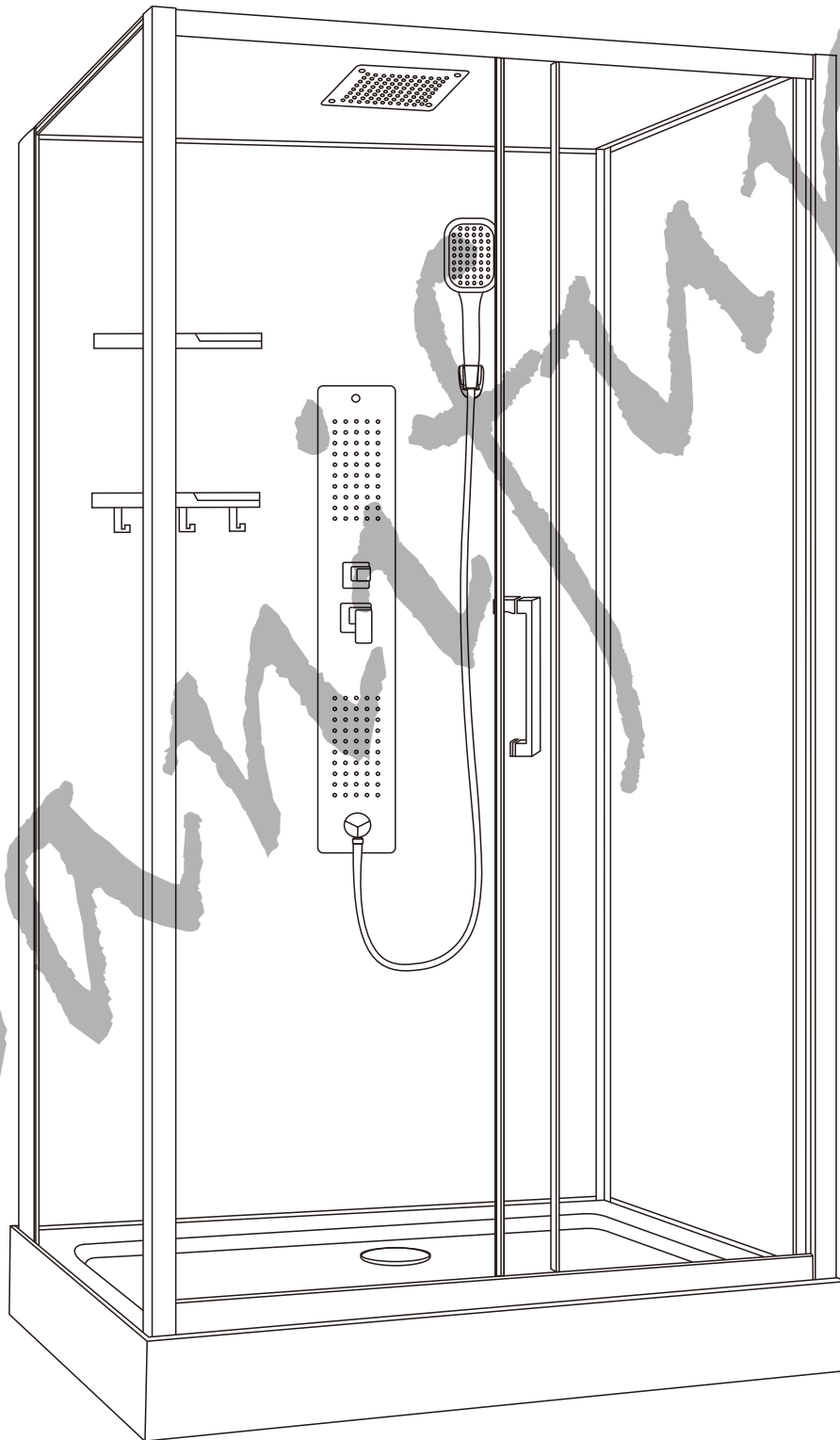

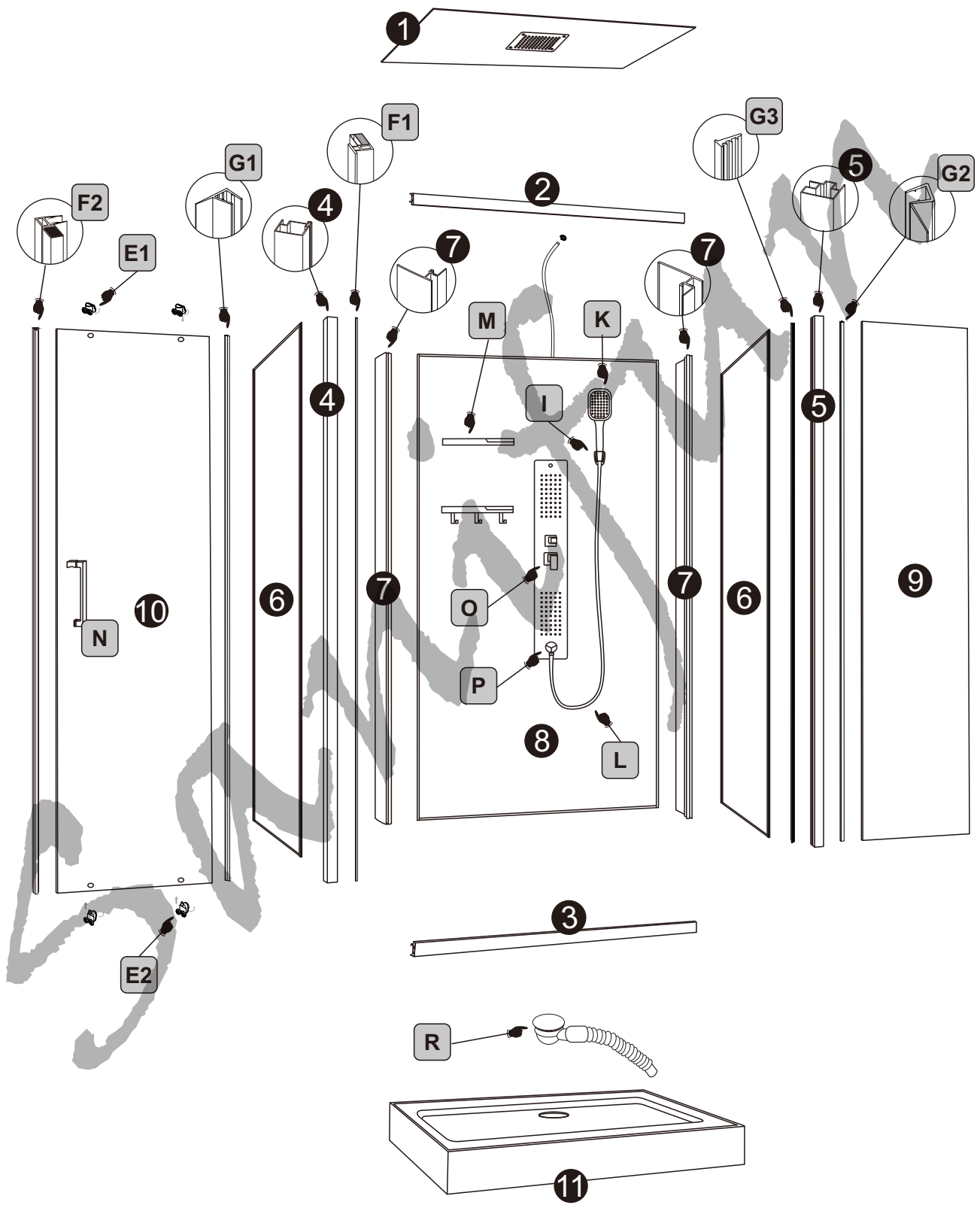

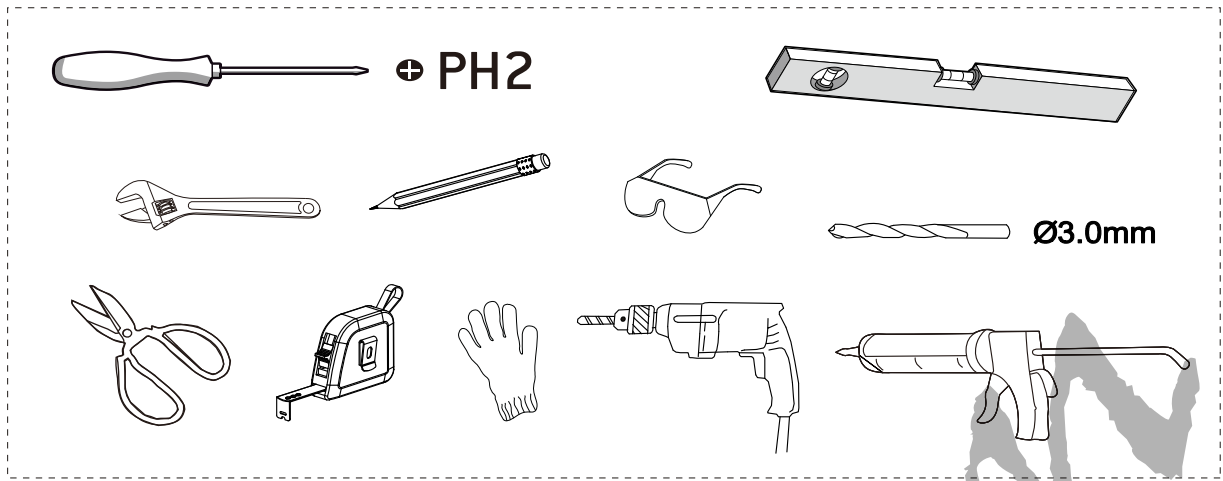

Handleiding van de Sanifun Complete douchecabine Mercury









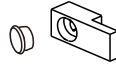
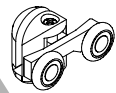

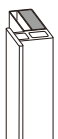

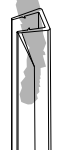







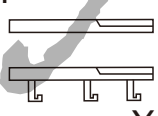

<p>A1</p>  <p>M4X25 X8</p>	<p>A2</p>  <p>M4X16 X7</p>	<p>A3</p>  <p>M4X10 X14</p>	<p>B1</p>  <p>M4X16 X7</p>	<p>B2</p>  <p>M4X20 X2</p>
---	---	--	--	---

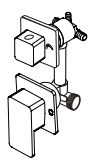
<p>B3</p>  <p>M5X16 X6</p>	<p>C</p>  <p>X2</p>	<p>D</p>  <p>M5 X21</p>	<p>E1</p>  <p>X2</p>	<p>E2</p>  <p>X2</p>
---	--	--	--	--

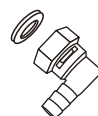
<p>F1</p>  <p>X1</p>	<p>F2</p>  <p>X1</p>	<p>G1</p>  <p>X1</p>	<p>G2</p>  <p>X1</p>	<p>G3</p>  <p>X1</p>
---	---	---	---	---

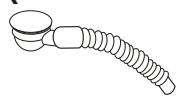
<p>H</p>  <p>X10</p>	<p>I</p>  <p>X1</p>	<p>J</p>  <p>M5 X15</p>	<p>K</p>  <p>X1</p>	<p>L</p>  <p>X1</p>
---	--	--	--	--

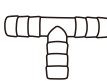

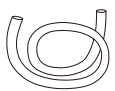
<p>M</p>  <p>X2</p>	<p>N</p>  <p>X1</p>	<p>O</p>  <p>X1</p>	<p>P</p>  <p>X1</p>	<p>Q</p>  <p>X3</p>
--	--	--	--	--

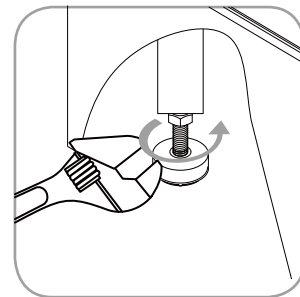
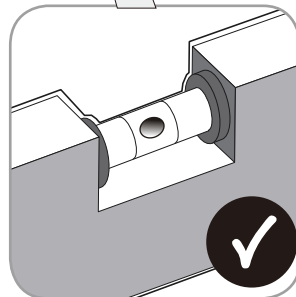
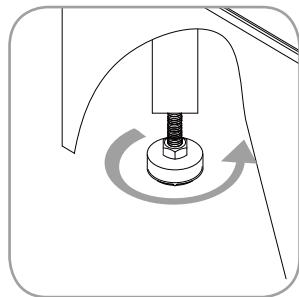
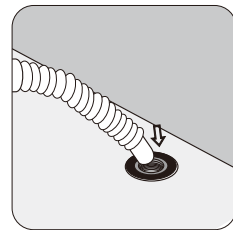
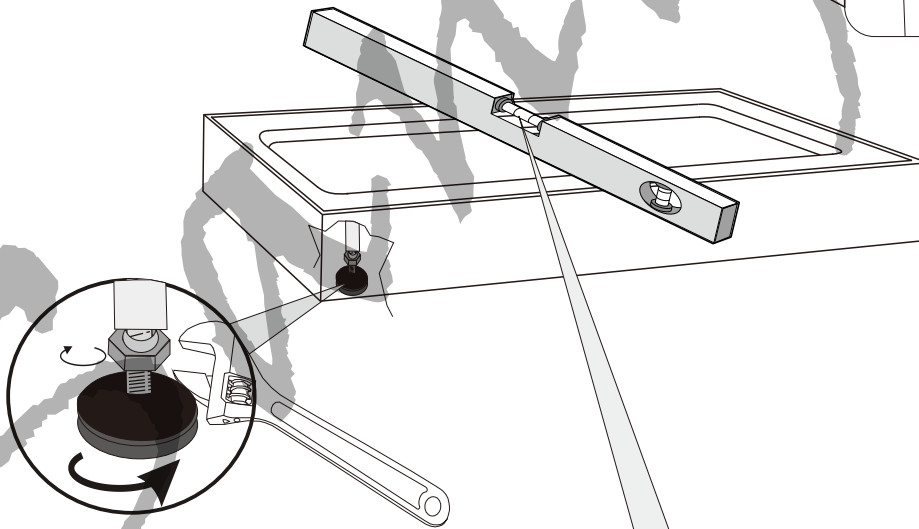
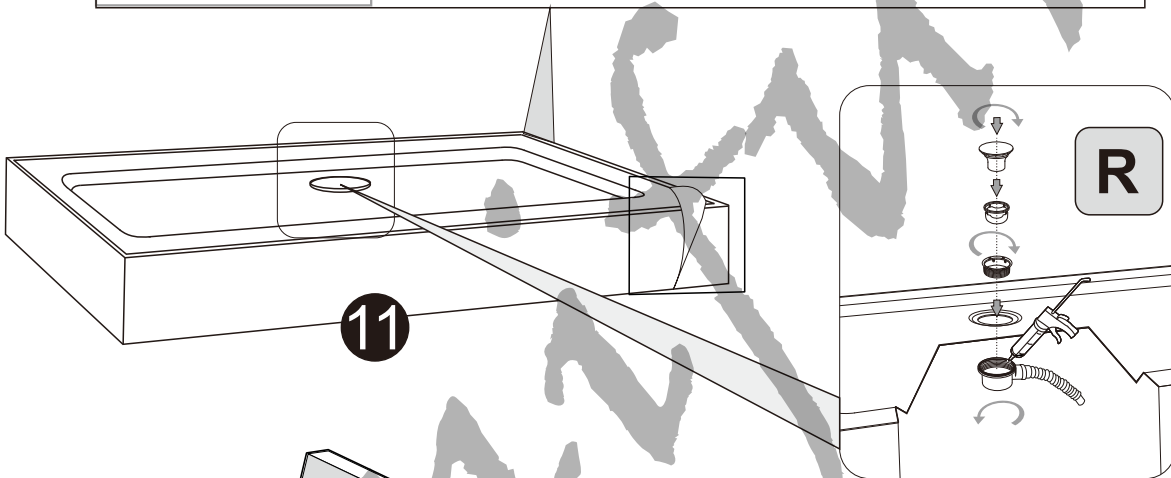
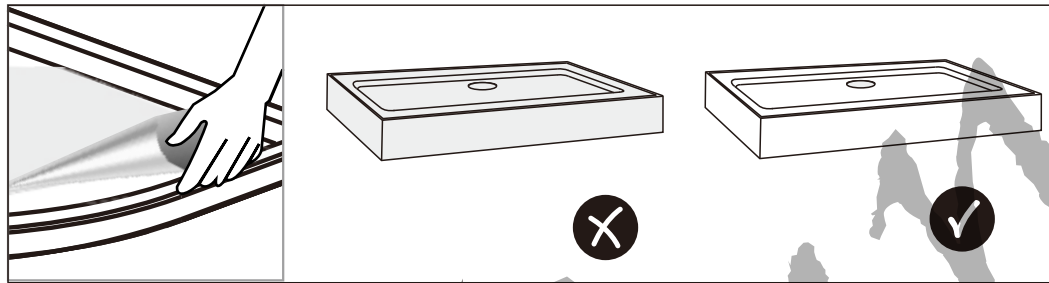
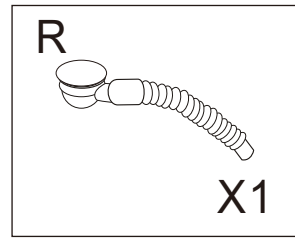
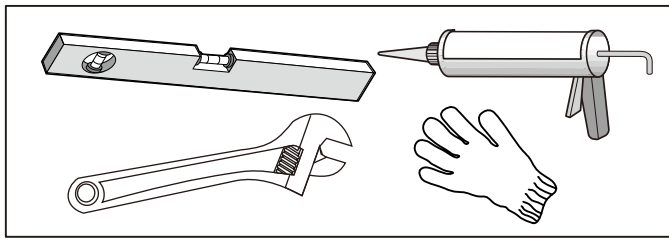
<p>R</p>  <p>X1</p>	<p>S1 S2</p>  <p>X14</p>	<p>T</p>  <p>X1</p>	<p>U</p>  <p>X8</p>	<p>W</p>  <p>X2.5M</p>
--	---	--	--	---

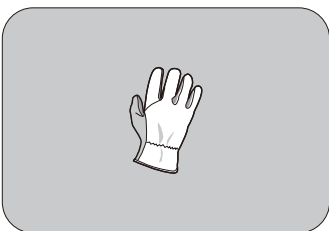
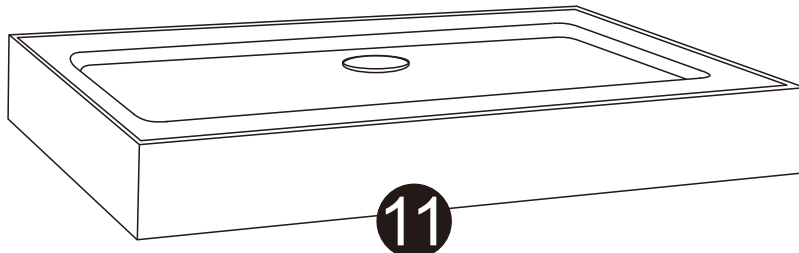
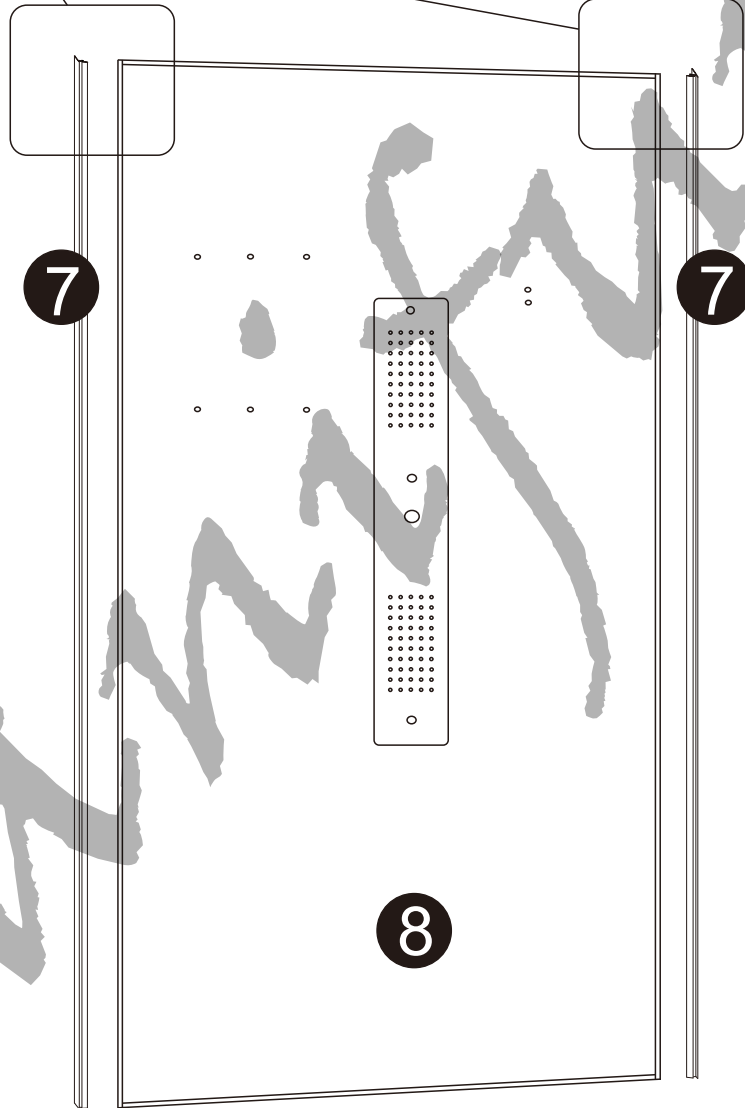
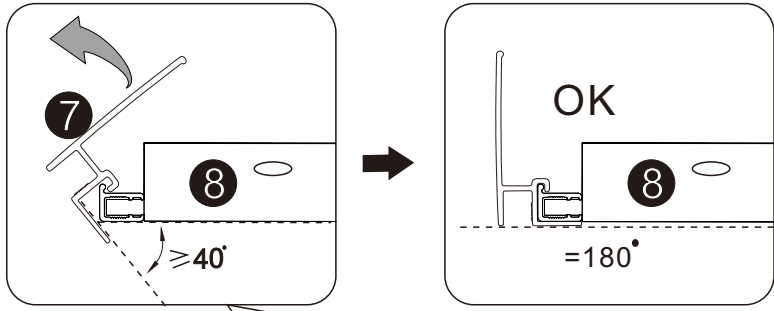

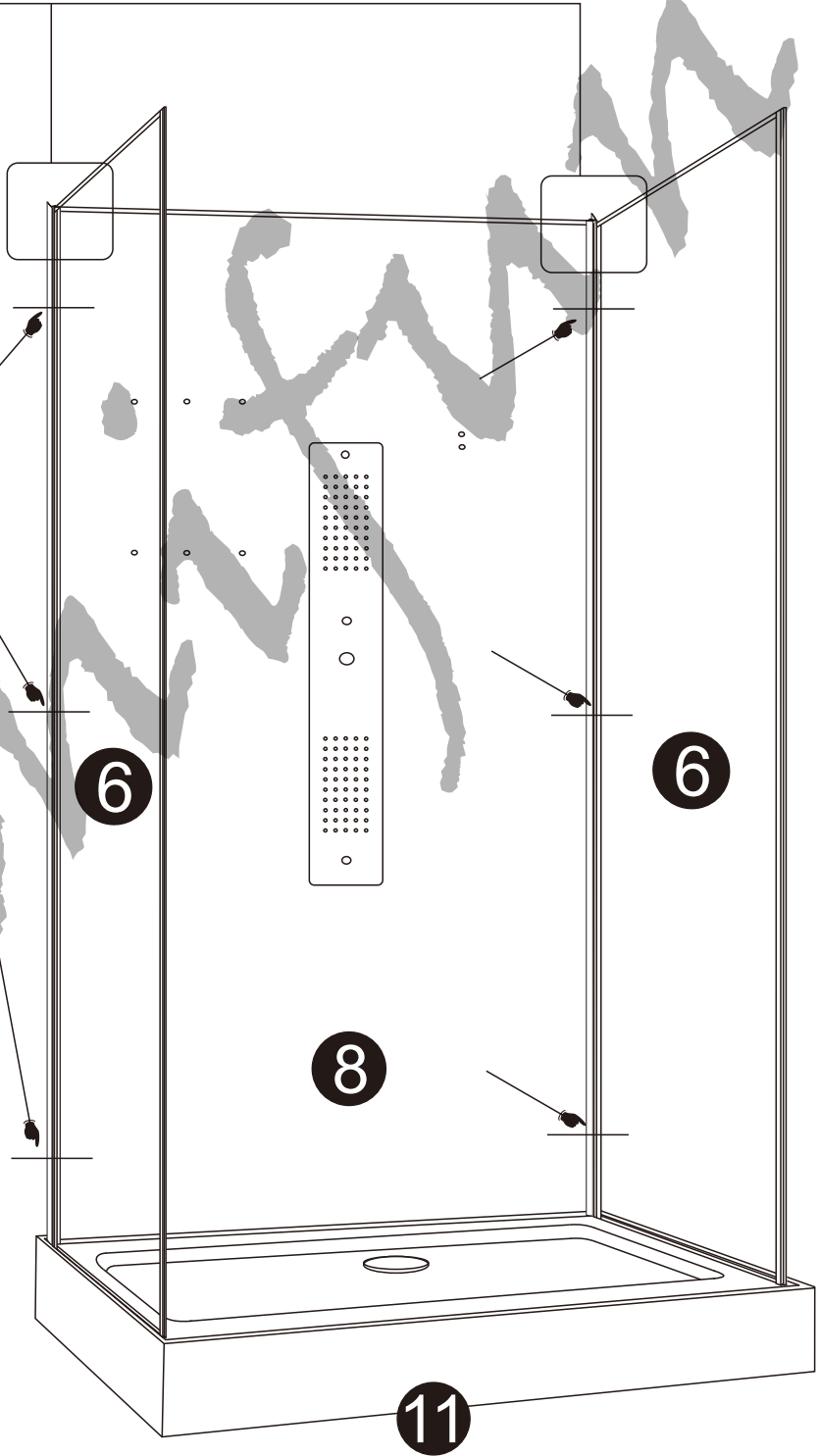
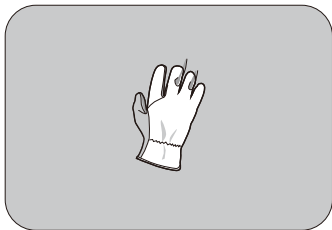
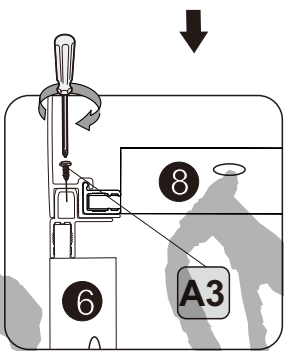
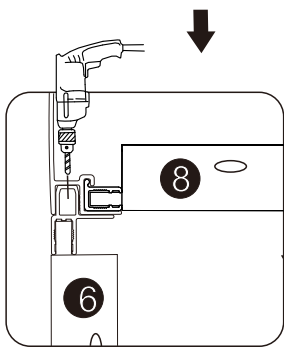
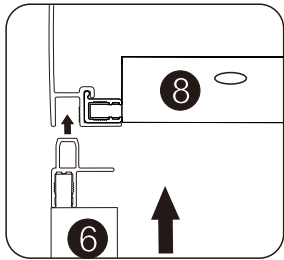
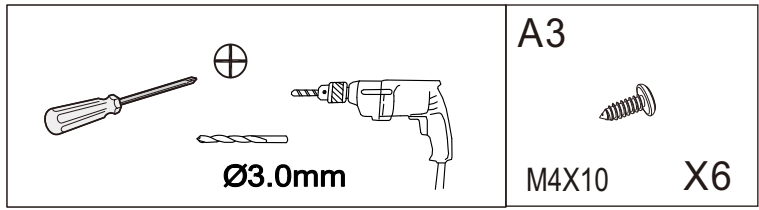

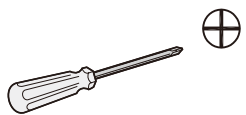



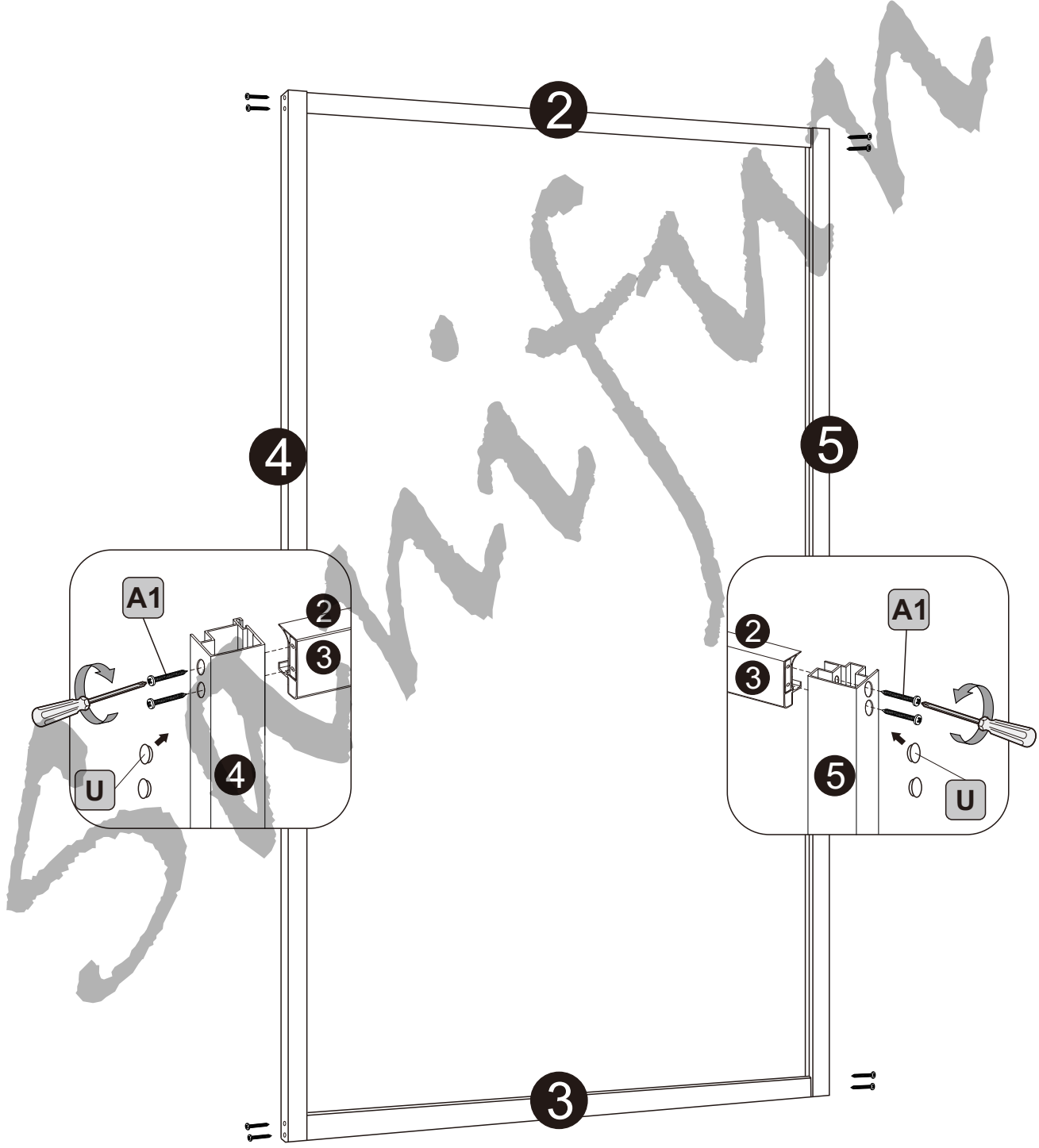

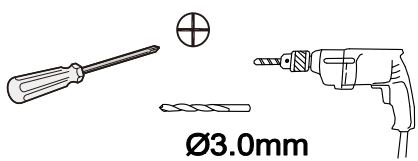





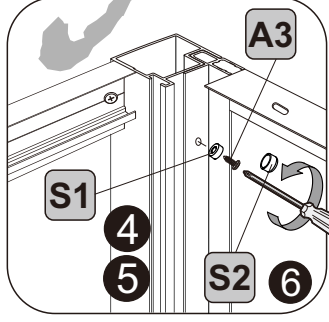
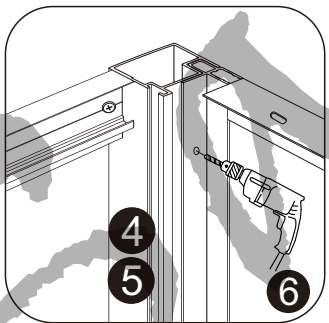
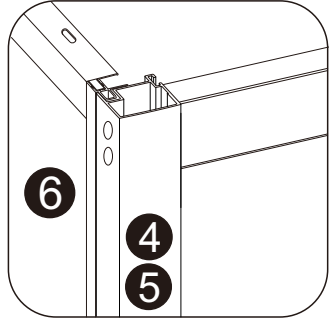
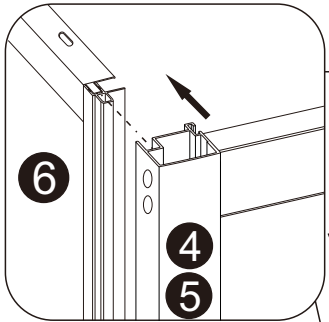
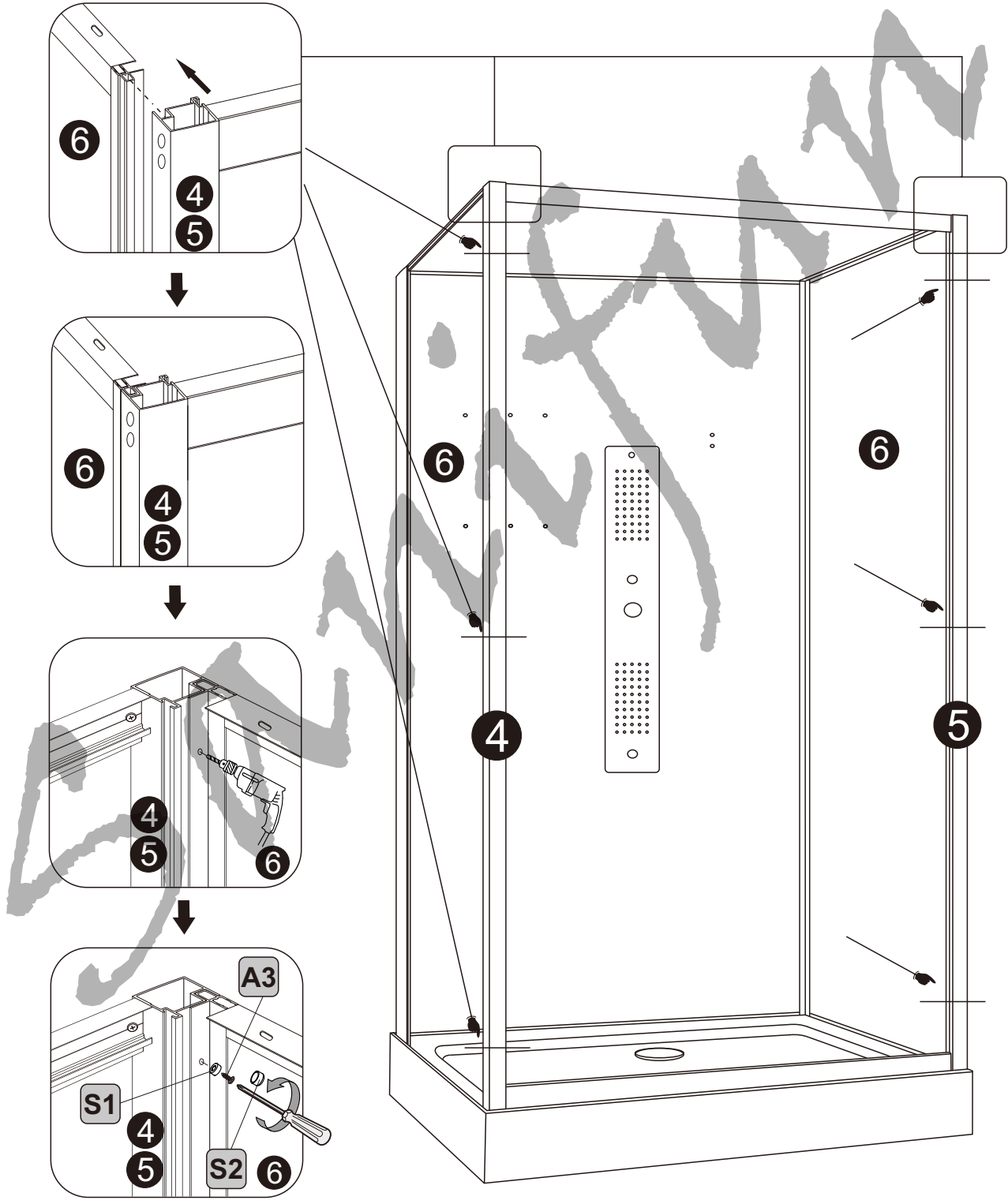

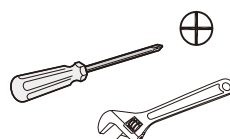
	<p>A1</p>  <p>M4X25 X8</p>	<p>U</p>  <p>X8</p>
---	---	--





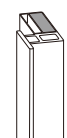

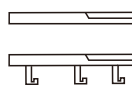
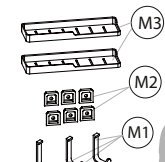

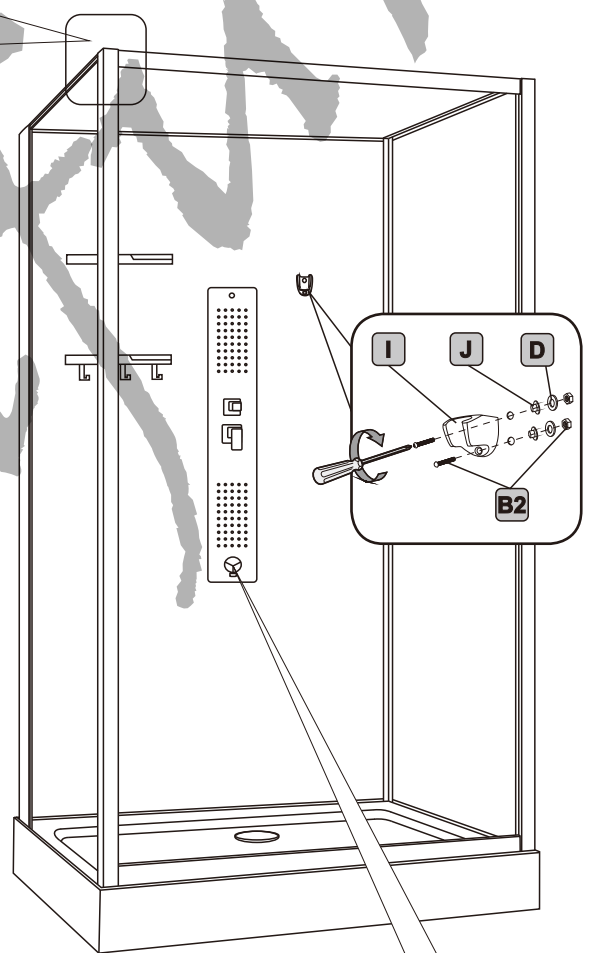
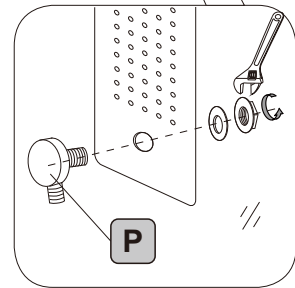
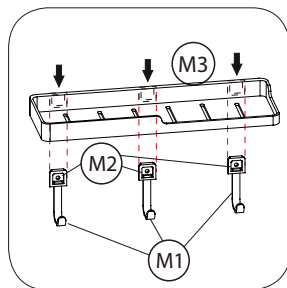
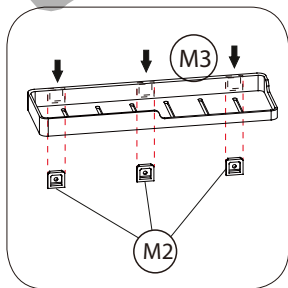
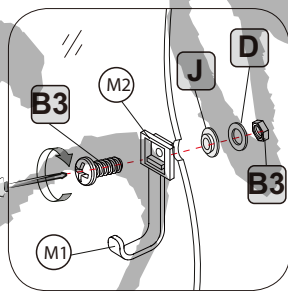
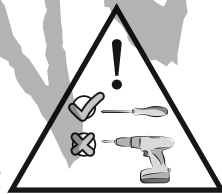
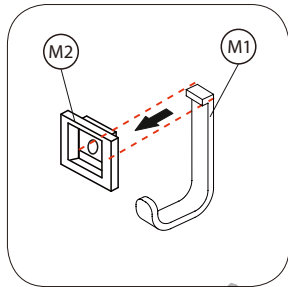
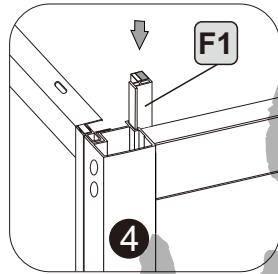
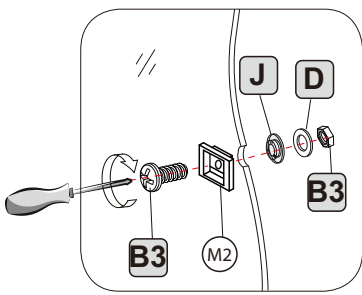
 <p>Ø3.0mm</p>	<p>A3</p>  <p>M4X10 X6</p>	<p>S1</p>  <p>X6</p>	<p>S2</p>  <p>X6</p>
---	---	---	---

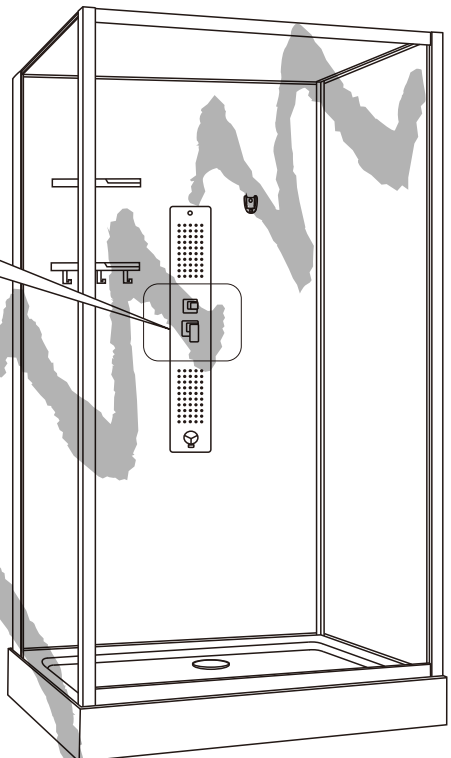
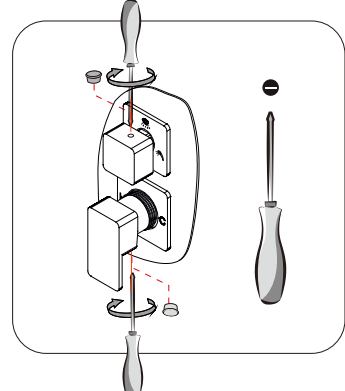
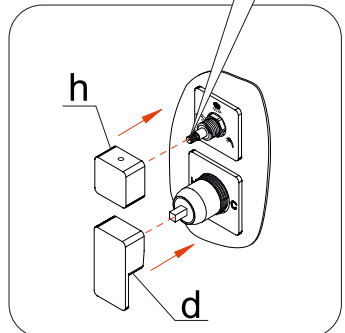
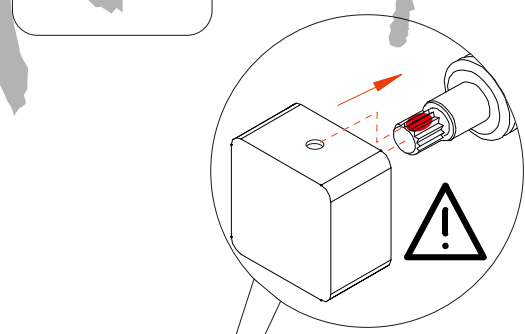
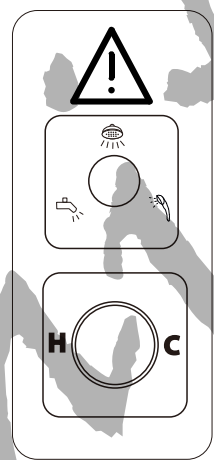
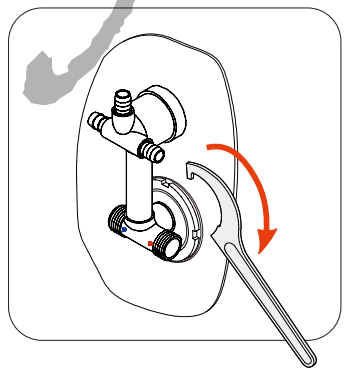
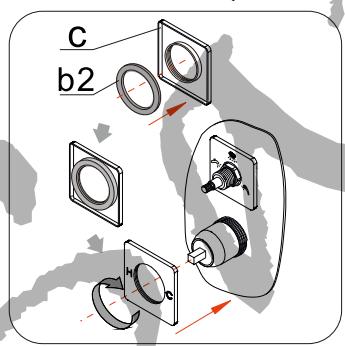
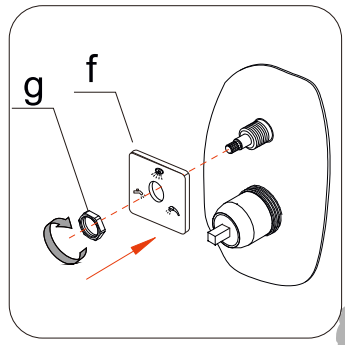
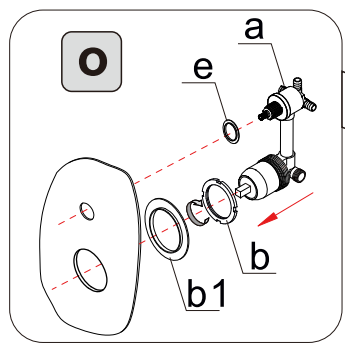
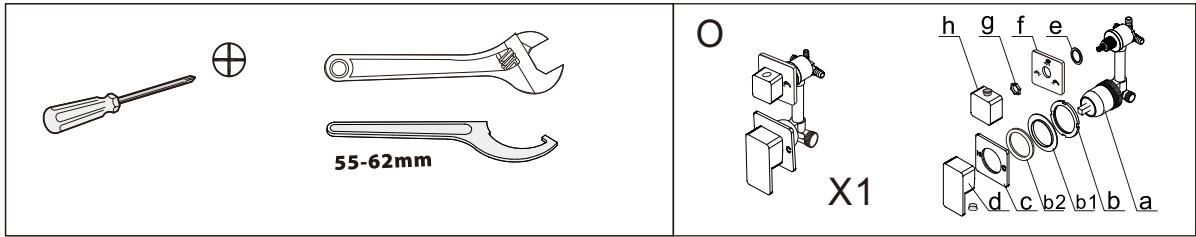

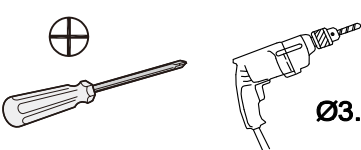





	B2  M4X20 X2	B3  M5X16 X6	D  M5 X8	J  M5 X8
I  X1	F1  X1	P  X1	M   X2	

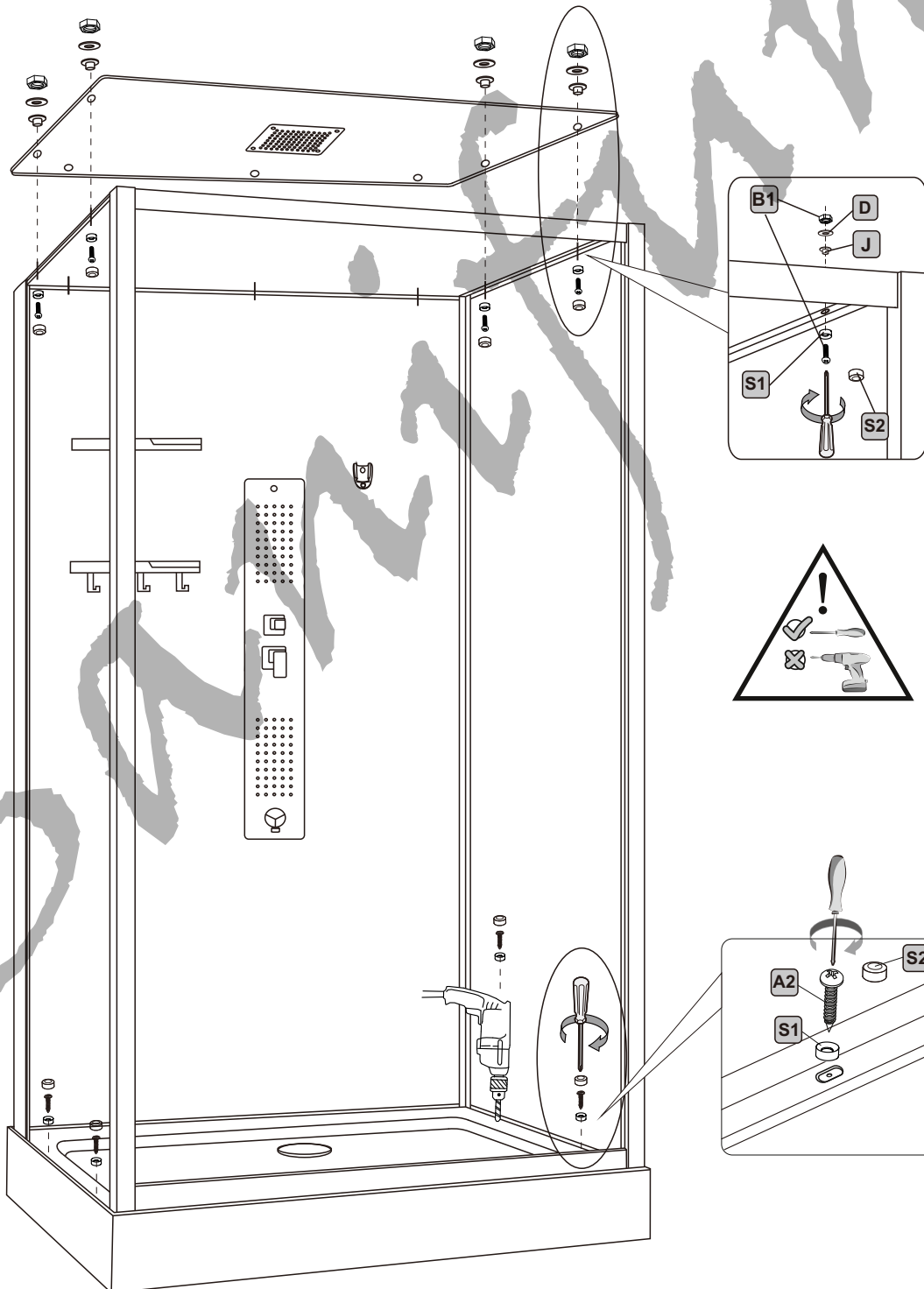

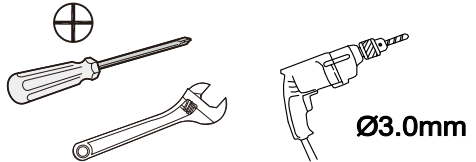



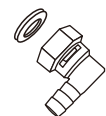
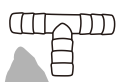

 Ø3.0mm	A2  M4X16 X4	B1  M4X16 X4	D  M5 X4
	J  M5 X4	S1  X8	S2  X8



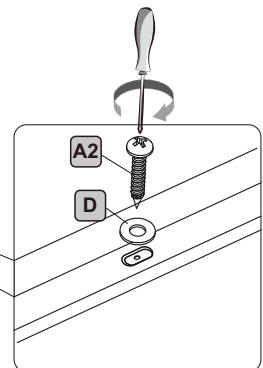
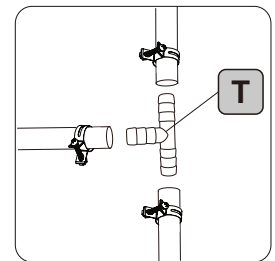
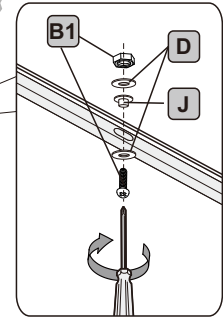
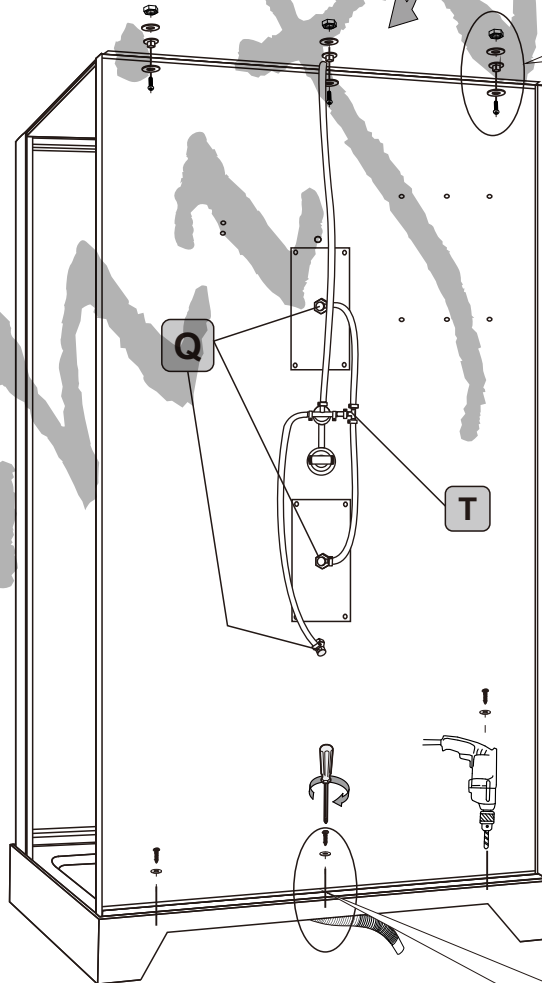
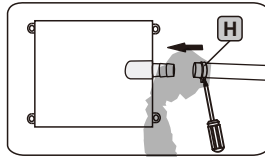
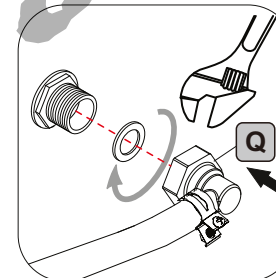
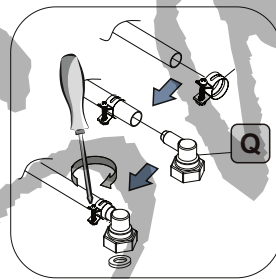
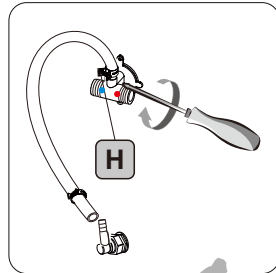
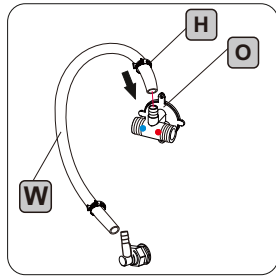

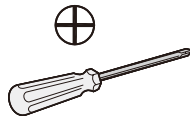
			A2  M4X16 X3	B1  M4X16 X3
D  M5 X9	J  M5 X3	H  X10	Q  X3	T  X1

W  X2.5M
--

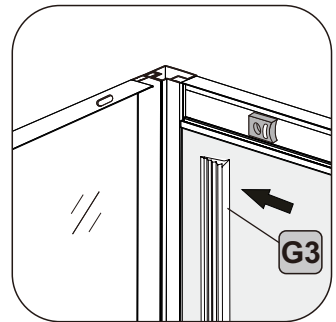
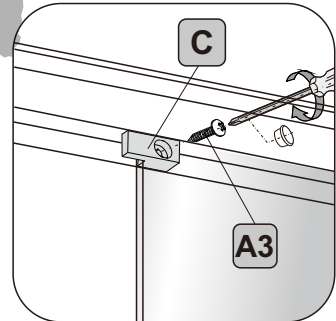
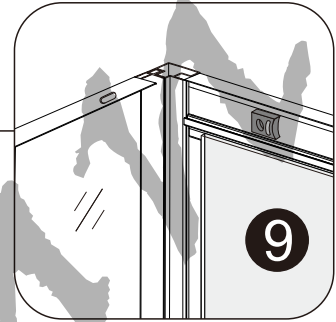
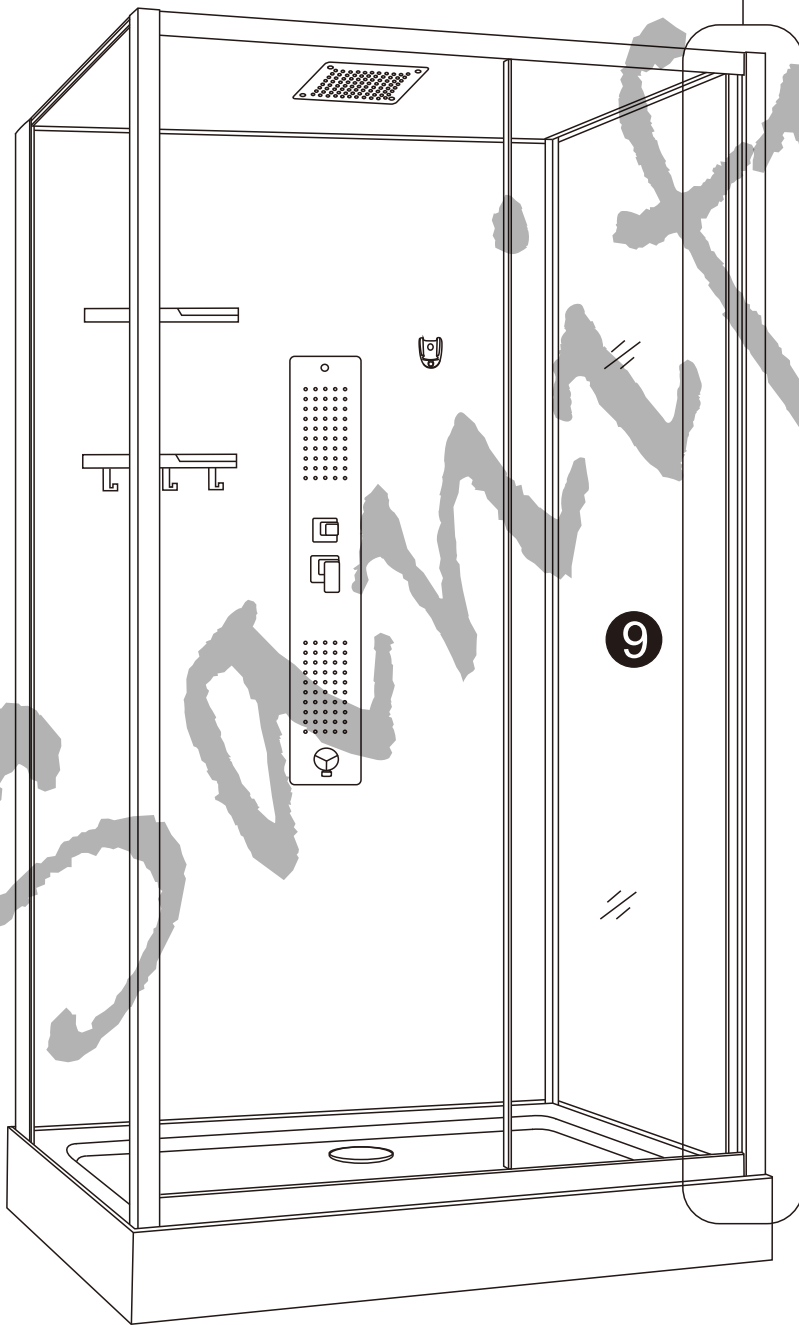

	A3  M4X10 X2	C  X2	G2  X1	G3  X1
---	---	--	---	---

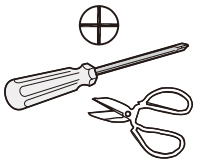

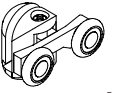
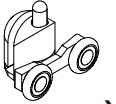
	F2  X1	G1  X1	E1  X2	E2  X2
---	---	---	---	---

N  X1
--

