

# BRAUN

## ThermoScan® 3

Infrared Ear Thermometer

百靈耳溫槍



IRT 3030



<b>EN</b>	<b>English</b> .....	<b>2</b>
<b>TC</b>	<b>繁體中文</b> .....	<b>13</b>

This product is manufactured under license to the 'Braun' trademark. 'Braun' is a registered trademark of Braun GmbH, Kronberg, Germany. ThermoScan® is a registered trademark of Kaz Europe Sàrl.

此產品以百靈商標認可生產。德國百靈公司(Braun GmbH, Kronberg, Germany)為百靈商標持有人。

ThermoScan® 是 Kaz Europe Sàrl 的註冊商標。

製造廠名稱/地址: Manufactured by Famidoc Technology Co., Ltd. (Address: No.212 Yilong Road, Hexi Industrial Zone, Jinxia, Changan Town, Dongguan, Guangdong Province, 523853, P.R. China) for Kaz Europe Sàrl (Address: Place Chauderon 18, CH-1003 Lausanne, Switzerland)

藥商名稱: 集德醫材管理顧問有限公司  
藥商地址: 新竹縣竹北市福德裏和平街8號10樓



© 2018 All rights reserved.

[www.braunhealthcare.com](http://www.braunhealthcare.com)

Designed by Kaz USA, Inc., a Helen of Troy Company. Made in China.

Patents / 專利:  
[www.kaz.com/patents/braun](http://www.kaz.com/patents/braun)

IRT3030

PN: A002212R0  
Revision date: 14JUN18

## Braun ThermoScan® 3 Infrared Ear Thermometer

### Indications for use

The Braun ThermoScan® 3 Infrared Ear Thermometer is indicated for the intermittent measurement and monitoring of human body temperature by consumers in a home use environment.

### IRT 3030

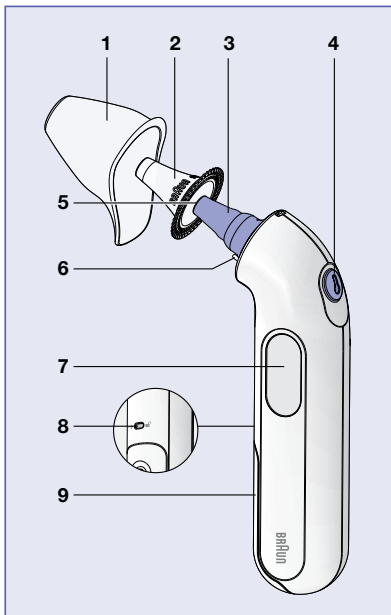

## Product description

- 1 Protective cap
- 2 Lens filter (Box of 20; Model: LF20)
- 3 Probe (Inserted with 1 pc of lens filter)
- 4 «start» button
- 5 Probe tip
- 6 Lens filter detector
- 7 Display
- 8 Battery door safety lock
- 9 Battery door (1 X 3V type 2032 battery)

The Braun ThermoScan® thermometer is indicated for intermittent measurement and monitoring of human body temperature for people of all ages.



## WARNINGS AND PRECAUTIONS

Please consult your doctor if you see symptoms such as unexplained irritability, vomiting, diarrhea, dehydration, changes in appetite or activity, seizure, muscle pain, shivering, stiff neck, pain when urinating, etc. in spite of absence of fever.

The operating ambient temperature range for this thermometer is 10 – 40 °C (50 – 104 °F).

Do not expose the thermometer to temperature extremes (below –25 °C (–13 °F) or over 55 °C (122 °F)) or excessive humidity (≤ 95% RH non-condensing).

This thermometer must only be used with genuine Braun ThermoScan® lens filters (LF 40). Other lens filters can lead to inaccuracy.

To avoid inaccurate measurements always use this thermometer with a new, clean, disposable lens filter attached.

If the thermometer is accidentally used without a disposable lens filter attached, clean the lens after use (see «Care and cleaning» section).

**Keep disposable lens filters out of reach of children.**

This thermometer is intended for household use only.

Use of this thermometer is not intended as a substitute for consultation with your physician.

This thermometer must stay in stable ambient (room) temperature for 30 minutes before operating.

## Audio fever indicator

Thermometer will signal by beeps normal, moderate or high temperature.

Temperature reading	Number of beeps
Normal ( $\leq 37.4$ °C or 99.3 °F)	One beep: )
Moderate ( $\geq 37.5$ °C or 99.5 °F)	Two beeps, repeated: )) )) ))
High ( $\geq 38.6$ °C or 101.5 °F)	Four beeps, repeated: )))) )))) ))))

## Body temperature

Normal body temperature is a range. It varies by site of measurement and it tends to decrease with age. It also varies from person to person and fluctuates throughout the day. Therefore, it is important to determine normal temperature ranges.

## How to use your Braun ThermoScan®

Before taking the temperature, make sure the ear is free from obstructions or excess earwax.

**Do not attempt to take the reading without a disposable lens filter on** – the measuring sensor must be kept protected and clean from earwax to give accurate readings.

Change the disposable lens filter with each use to ensure hygiene, to keep child safe from cross-contamination and to ensure earwax residues on the disposable lens filter do not impact accuracy of the reading.

1. To turn the thermometer on, push the «start» button (4).

During an internal self-check, the display shows all segments.



The reading showed on the screen is the last temperature taken.



Flashing symbol of lens filter will appear if no lens filter is attached. Temperature can be taken only if lens filter is mounted on the probe.



The thermometer is ready to use after two beeps are sounded and the non-flashing ear icon appears.



2. Fit the probe (3) snugly into the ear canal, then push the «start» button (4).

One beep signals normal temperature. Audio fever indicator will trigger 2 consecutive beeps when the reading is equal or higher to 37.5 °C (99.5 °F) and 4 beeps if the reading is equal or higher to 38.6 °C (101.5 °F). The result is shown on the display (7).

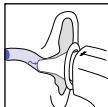

3. Gently pull off the disposable lens filter (2).

**Do not use force in removing the disposable lens filter.**

4. Put on a new, clean, disposable lens filter by snapping into position.



5. Place the protective cap on (1).

The Braun ThermoScan® ear thermometer turns off automatically after 60 seconds of inactivity. The thermometer can be turned off by pressing and holding the «start» button for more than 5 seconds.

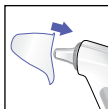

## Disposable lens filters

Use a clean disposable hygienic lens filter with each measurement:

1. To ensure hygienic use.
2. To protect your child from cross-contamination.
3. To ensure earwax residues do not impact accuracy of the reading.

Earwax and dirt on the tip of the disposable lens filter, even in microscopic layer, can create an obstacle between the sensor and the infrared heat emitted by the ear and impact the accuracy of the measurement.



**Note:** Lens filter is single-use, disposable item.

## Temperature taking hints

- Replace the disposable lens filter with every use to maintain hygiene and accuracy.
- A measurement taken in the right ear may differ from the measurement taken in the left ear. Therefore, always take the temperature in the same ear.
- The ear must be free from obstructions or excess earwax build-up to take an accurate reading.
- External factors may influence ear temperatures, including when an individual has:
  - been lying on one ear or the other
  - had their ears covered
  - been exposed to very hot or very cold temperatures, or
  - been recently swimming or bathing.

In these cases, remove the individual from the situation and wait 20 minutes prior to taking a temperature.



- If ear drops or other ear medications have been placed in the ear canal of one ear, take the temperature in the untreated ear.

## Care and cleaning

The probe tip (5) is the most delicate part of the thermometer. It must be clean and intact to ensure accurate readings.

If the thermometer is ever accidentally used without a disposable lens filter, clean the probe tip as follows:

Very gently wipe the surface with a cotton swab or soft cloth moistened with alcohol. Do not use cleaners other than alcohol on the probe tip. Use of other cleaners could damage the tip.





Once the alcohol has completely dried out, you can put a new lens filter on and take a temperature measurement. If the probe tip is damaged, please contact your authorized local service center.





Use a soft, dry cloth to clean the thermometer display and exterior. Do not use abrasive cleaners. Never submerge this thermometer in water or any other liquid.

Store thermometer and disposable lens filters in a dry location free from dust and contamination and away from direct sunlight.

Additional lens filters (LF 40) are available at most stores carrying Braun ThermoScan®.

## Troubleshooting

Situation	Solution
 No disposable lens filter is attached.	Attach new, clean, disposable lens filter.
 Measurement before device stabilization.	Wait until all the icons stop flashing.

Situation	Solution
 <p>Ambient temperature is not within the allowed operating range (10 – 40 °C or 50 – 104 °F).</p>	<p>Allow the thermometer to remain for 30 minutes in a room where the temperature is between 10 and 40 °C or 50 and 104 °F.</p>
 <p>Temperature taken is not within typical human temperature range (34 – 42.2 °C or 93.2 – 108 °F)</p>	<p>Make sure the probe tip and lens are clean and a new, clean, disposable lens filter is attached. Make sure the thermometer is properly inserted. Then, take a new temperature.</p>
 <p>System error</p>	<p>Reset the thermometer by removing the battery and then replacing it again, wait 1 minute, then turn on again.</p> <p>If error still persists, please contact your authorized service center.</p>
 <p>Battery is low.</p>	<p>Insert new battery.</p>
 <p>Battery is too low. Device cannot be powered on to the ready state.</p>	<p>Insert new battery.</p>
<p>Do you have any further questions?</p>	<p>Please contact your authorized service center.</p>

## Changing the temperature scale

Make sure the thermometer is turned off. Press and hold down the «start» button. Keep holding down the «start» button and after about 3 seconds the display will start to cycle between temperature scales (°C or °F).

Release the start button when the desired scale is shown. This will reset the thermometer to the new temperature scale.



## Replacing the battery

The thermometer is supplied with one 3V Lithium cell battery (type 2032). Insert new battery when the low battery symbol appears on the display.

The battery door design is intended to prevent a small child from easily opening the battery door to address a possible choke hazard. Open the battery compartment by inserting a narrow pointed object such as a ball point pen or paperclip into the small hole above the battery door (8). While pressing into the hole slowly slide back the battery door with the other hand.

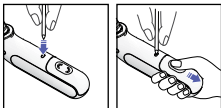

To close battery door align the tabs along the side of the battery into the battery compartment and slowly slide back into position until the door clicks into its locked position.

## Calibration

This product has been calibrated at the time of manufacture. If this thermometer is used according to the use instructions, periodic calibration is not required. If at any time you question the accuracy of the temperature measurement, please contact your authorized service center.

Manufacturing date is given by the LOT number located in the battery compartment.

The first three (3) digits after LOT represent the Julian date that the product was manufactured and the next two (2) digits represent the last two numbers of the calendar year the product was manufactured. The last identifiers are the letters that represent the manufacturer.

An example: LOT 11614fam, this product has been manufactured on the 116th day of the year 2014.

## Limited warranty

This product comes with limited warranty commencing on the date of purchase. Within the warranty period we will eliminate, free of charge, any defects in the appliance resulting from faults in materials or workmanship, by replacing the complete appliance.

This warranty is applicable only for the appliance supplied by the appointed distributor. This warranty does not cover: damage due to improper use, normal wear or use as well as defects that have a negligible effect on the value or operation of the appliance. The warranty becomes void if repairs are undertaken by unauthorized persons and if original Braun parts are not used.

## Model and product specifications

### Product specifications

Product:	ThermoScan® IRT 3030
Temperature measurement within seconds:	■
Temperature range °C:	34 °C – 42.2 °C
Temperature range °F:	93.2 °F – 108 °F
Feedback system:	■
Ready beep:	■
Small, soft tip:	■
Flexible tip:	■
Memory storage capacity:	■
Auto-off after 60 sec.:	■
Size:	(D) 55.6mm x (L) 128.5mm x (W) 22.8mm
Weight:	57.5g (with batteries); 54.5g (w/o batteries)
Easy-to-read LCD display:	■
Lens filter detector:	■
Protective cap with lens filter:	■
Batteries included:	■
21 lens filter included:	■
Color:	White

Operating ambient temperature range:	10 °C – 40 °C (50 °F – 104 °F)
Storage temperature:	-25 °C – 55 °C (-13 – 131 °F)
Display resolution:	0.1 °C or °F
Accuracy for displayed temperature range:	35.5 – 42 °C (95.9 – 107.6 °F) ± 0.2 °C (± 0.4 °F)
Outside this temperature range:	± 0.3 °C (± 0.5 °F)
Clinical bias:	-0.11 °C (-0.198 °F)
Limits of agreement:	± 0.25 °C (0.45 °F)
Measuring Site:	Ear
Reference Site:	Oral (estimated oral temperature is displayed)

Operating and storage relative humidity:	≤ 95% non-condensing
Warranty:	2 years

If device is not used or stored within specified temperature and humidity ranges the technical accuracy cannot be ensured.



Equipment with type  
BF applied parts



See Instruction for use



Operating temperature



Storage temperature



Keep it dry

Subject to change without notice.

IP22: Protected against solid foreign objects of 12.5 mm diameter and greater. Protected against vertically falling water drops when the device is tilted up to 15 degrees.

EN 12470-5:2003 Clinical thermometers – Part 5: Performance of infra-red ear thermometers (with maximum device)

ISO 80601-2-56:2009 Medical electrical equipment – Part 2-56: Particular requirements for basic safety and essential performance of clinical thermometers for body temperature measurement

This product conforms to the provisions of the EC directives 93/42/EEC (Medical Device Directive) and 2011/65/EU (RoHS).

The Braun ThermoScan® needs special precautions regarding EMC. For detailed description of EMC requirements please contact your authorized service center.

Portable and mobile RF communications equipment can affect the Braun ThermoScan®.



Please do not dispose of the product in the household waste at the end of its useful life. To protect the environment, dispose of empty batteries at appropriate collection sites according to national or local regulations.

## 百靈耳溫槍

## Braun ThermoScan® 3 Infrared Ear Thermometer

型號：IRT3030

衛部醫器輸字第

號

使用前請務必詳閱原廠之使用說明書並遵照指示使用。

產品敘述與用途：

本產品用於間歇性測量和觀察體溫，且僅供家居使用。

## IRT 3030

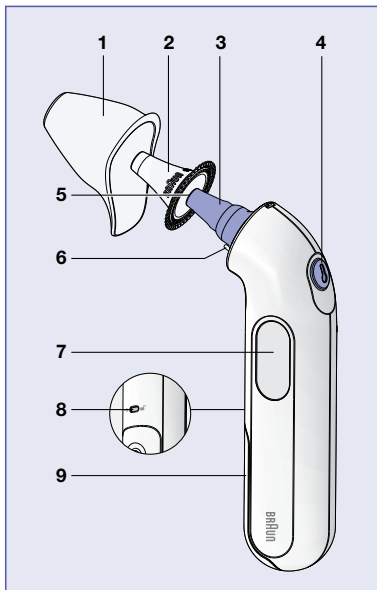

## 產品說明

- 1 保護蓋
- 2 耳套 (20個一盒)  
(型號：LF20；許可證字號：衛部醫器輸字第 025364 號)
- 3 測溫頭 (已預先裝置耳套1個)
- 4 «start» 按鈕
- 5 位置偵測器
- 6 耳套偵測器
- 7 顯示幕
- 8 電池蓋安全鎖
- 9 電池蓋 (1 x 2032型3V電池)

百靈耳溫槍用於間歇性測量和觀察不同年齡人士的體溫。



## 警告和注意事項

如身體出現原因不明的煩躁不安、嘔吐、腹瀉、脫水、食慾或行為模式出現變化、癲癇、肌肉疼痛、顫抖、脖子僵硬、小便疼痛等症狀，即使沒有發燒跡象，亦應儘快求醫。

本產品使用時的外圍環境溫度範圍必須在10–40°C (50–104°F) 之間。

請勿將本產品置於惡劣的溫度環境下 (低於 –25°C (13°F) 或高於 55°C (122°F)) 或過於潮濕的地方 (≤ 95% RH 無凝結)。

本產品必須與百靈耳套 (型號：LF 40) 搭配使用，其它品牌耳套可能導致測量誤差。

每次測量前請更新的耳套避免測量誤差。

若不小心沒有使用耳套進行測量，使用後請清潔測溫頭。  
(參閱「保養和清潔」部分)。

請將耳套置於孩童拿不到的地方。

本產品僅供家用。



本產品不能代替醫生的診療。

使用本產品前請將其置於穩定的環境下30分鐘。

## 發燒響聲指示

耳溫槍會發出「嗶」聲來表示體溫正常、輕度發燒和高燒。

溫度讀數	響聲次數
正常 ( $\leq 37.4^{\circ}\text{C}$ 或 $99.3^{\circ}\text{F}$ )	一次： )
輕度發燒 ( $\geq 37.5^{\circ}\text{C}$ 或 $99.5^{\circ}\text{F}$ )	兩次，重複： )) )) ))
高燒 ( $\geq 38.6^{\circ}\text{C}$ 或 $101.5^{\circ}\text{F}$ )	四次，重複： )))) )))) ))))

## 體溫

人體的正常體溫是一個範圍。正常體溫範圍會因不同測量部位而有所不同，亦會隨著年齡的增長而下降。每個人均有自己的正常體溫範圍，而人體於一天內的體溫會在該範圍內浮動。因此，確定自己的正常體溫範圍很重要。

## 如何使用百靈耳溫槍

在測量體溫前，要確保耳道潔淨及沒有太多耳垢。

切勿不使用耳套測量體溫，以免損壞測溫頭，或因耳垢弄污測溫頭而影響讀數的準確度。

每次測量體溫都應使用新的一次性耳套，以避免兒童交叉感染，以及避免殘留於隔離套的耳垢影響讀數準確度。

1. 按 «start» 按鈕 (4) 開機。

在耳溫槍進行開機自檢時，顯示幕各區域都會顯示內容。



顯示幕會顯示上次測量的結果。



如果未套上耳套，顯示幕會閃爍顯示耳套標誌。耳溫槍必須套上耳套才可測量體溫。

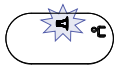

耳溫槍鳴響兩次，且顯示幕顯示不閃爍的耳朵標誌時，代表耳溫槍已可操作。



2. 把測溫頭 (3) 塞入耳道，然後按 «start» 按鈕 (4)。

耳溫槍鳴響一聲代表體溫正常；如果體溫達  $37.5^{\circ}\text{C}$  ( $99.5^{\circ}\text{F}$ ) 或以上，耳溫槍會鳴響兩聲；若達  $38.6^{\circ}\text{C}$  ( $101.5^{\circ}\text{F}$ ) 或以上，耳溫槍更會鳴響四聲。體溫讀數顯示於顯示幕 (7)。

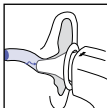

3. 輕輕取下一次性耳套 (2)。

切勿猛力拔出耳套。



4. 套上全新、潔淨的一次性耳套。



5. 套上保護蓋 (1)。

在閒置 60 秒後會自動關機；按住 «start» 按鈕 5 秒以上亦可關機。

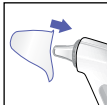

## 一次性耳套

每次測量體溫都應使用新的潔淨一次性耳套：

1. 以確保衛生；
2. 防止孩子交叉感染；
3. 防止耳垢影響讀數的準確度。

一次性耳套上即使殘留極少量的耳垢或污垢，亦會在感應器和耳朵發出的紅外線之間構成阻礙，從而影響測量的準確度。



注意: 耳套屬於一次性使用。

## 測量體溫小秘訣

- 為確保測量準確性及衛生考慮，每次測量前請先裝上一個全新的耳套。
- 從左右耳所測得的溫度可能有所不同，因此，請固定測量同一側的耳朵。
- 耳道若被阻塞或累積耳垢時也會影響測量的準確性。
- 下面還有一些可能影響耳溫測量的外在因素，包括當：
  - 側躺時壓到一邊的耳朵
  - 耳朵被覆蓋
  - 位於非常熱或非常冷的環境
  - 剛游泳或沐浴
- 請先排除以上這些情形，等待20分鐘後再測量耳溫。
- 如果耳朵內部有藥物治療時，請測量另一隻未受治療的耳朵。

## 保養和清潔

測溫頭 (5) 是耳溫槍最精密的部份，必須定期清潔保持其完整性才能確保測量準確性。

若耳溫槍未套上耳套即進行測量，請依以下步驟清潔測溫頭：

使用棉花棒或棉布沾酒精輕輕擦拭表面。

當酒精完全乾燥後，套上一個全新的耳套即可進行測量。若測溫頭有損毀，請與原購買之經銷商聯絡。

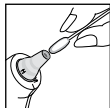





使用軟布擦拭耳溫槍的顯示幕及外殼。請勿使用具腐蝕性的清潔劑。不得將耳溫槍浸入水中或任何液體中。



耳溫槍及耳套請存放在乾燥、無灰塵及不會受到日曬的地方。

耳套 LF 40 可以在銷售百靈耳溫槍的經銷商購買到。

若有其它問題請聯絡本地售後服務維修中心。

## 故障排除

狀況	解決方法
 沒有套上耳套。	套上一個全新潔淨的耳套。
 無法正確讀取量值。	等候直至所有符號停止閃爍。
 環境溫度在正常溫度 (10 – 40 °C 或 50 – 104 °F) 之外。	將耳溫槍放在正常室溫下 10 – 40 °C (50 – 104 °F) 靜候 30 分鐘。
 測得的溫度不在正常人體溫度範圍內 (34 – 42.2 °C 或 93.2 – 108 °F)。	請先確認耳溫槍已經套上一個全新的耳套，且以正確的方式插入耳朵，然後再測量一次耳溫。
 系統故障	取出電池，等候一分鐘後再裝上電池，重新操作。 如果故障訊息無法消除，請與經銷商聯絡。

狀況	解決方法
 電力不足，耳溫槍仍能操作。	更換新電池。
 電力不足，無法測得正確體溫。	更換新電池。
您還有其它問題嗎？	請與經銷商聯絡。

## 切換溫度單位

首先要確保耳溫槍已關機，然後按住 «start» 按鈕，約 3 秒後，顯示幕會切換顯示溫度單位 (°C 或 °F)。



見到顯示幕顯示您所要的溫度單位時鬆開 «start» 按鈕，即完成切換。



## 更換電池

耳溫槍附送一顆 3 伏特 2032 型鋰電池。顯示幕顯示電池電量低標誌時，請換上新電池。

電池蓋的設計可防止小童輕易將其打開，以防造成窒息。把原子筆或迴紋針等尖頭物件插入電池蓋上方的小孔 (8)，然後在按住小孔的同時，用另一隻手把電池蓋慢慢向後推便可打開電池蓋。

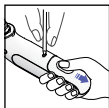
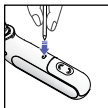

裝回電池蓋時，把電池側面的扣對準電池盒，然後慢慢推回原位至扣緊。

## 校正

本耳溫槍在製造時已校正過；若確實遵照本使用說明操作本產品，無需再作定期校正。若你懷疑測量值的準確性，請聯絡售後服務熱線。

製造日期請參見電池槽的產品編號。

LOT後第一、二、三碼表示該年份的製造日，第四、五碼表示製造年份，最後的字母是製造商的代號。

舉例：LOT11614fam 代表產品於2014年第116日製造。

## 有限保固

本產品保固期為自購買日起計。在產品保固期內，我們會就因產品用料或工藝導致的故障提供免費保固，並會視情況作出維修或更換。本保固適用於授權分銷商銷售本產品的國家。

本保固並不涵蓋：因不當操作、正常磨損或使用造成的損壞，以及對本設備的數值或操作無明顯影響的瑕疵。若經非授權人士維修，或維修時不使用原廠百靈零件，保固將即時失效。

## 型號及規格

## 產品規格

產品型號：	ThermoScan® IRT 3030
數秒內可測量溫度：	■
溫度顯示範圍 °C：	34 °C – 42.2 °C
溫度顯示範圍 °F：	93.2 °F – 108 °F
反饋系統：	■
短嗶聲：	■
微小、柔軟的尖端：	■
有彈性的尖端：	■
記憶功能：	■
使用後自動關機：	60秒
機體尺寸：	(高) 55.6mm x (長) 128.5mm x (寬) 22.8mm
重量：	57.5g (含電池)；54.5g (不含電池)
液晶螢幕：	■
耳套偵測器：	■
保護蓋連耳套：	■
含電池：	■
含耳套：	■
顏色：	白色

操作環境溫度範圍： 10 °C – 40 °C (50 °F – 104 °F)

存放溫度範圍： -25 °C – 55 °C (-13 – 131 °F)

顯示精確位數： 0.1 °C 或 °F

顯示溫度範圍的精確度： 35.5 – 42 °C (95.9 – 107.6 °F)

± 0.2 °C (± 0.4 °F)

此範圍以外 ± 0.3 °C (± 0.5 °F)

臨床偏差： -0.11 °C (-0.198 °F)

協議限制： ± 0.25 °C (0.45 °F)

測量部位： 耳

參考部位： 口腔 (顯示估計口腔溫度)

操作及存放相對濕度： ≤ 95% 無凝結

保固期： 2 年

若產品未在指定溫度及濕度內操作，則無法確認測量準確性。



含BF類應用部件  
的設備



請參考操作指示



操作溫度



存放溫度範圍



保持乾燥

以上內容如有更改，恕不另行通知。

IP22：防止直徑 12.5 毫米或以上的固體異物。在設備傾斜度不超過 15 度時防止垂直落下的水滴。

EN 12470-5：2003《臨床體溫計》第五部分：含有大量裝置的紅外線耳溫計的效能。

ISO 80601-2-56：2009醫療器械 - 第 2 - 56 部分：有關用於測量體溫的臨床溫度計的基本安全及基本效能的特定要求

本產品符合EC指引93/42/EEC(醫療器械)及2011/65/EU(RoHS)的規定。

百靈耳溫槍需要在電磁兼容性方面作出特殊的預防措施。

便攜及流動型射頻通訊設備會影響百靈ThermoScan®耳溫槍。



本產品含電池及可回收電子廢物。為保護環境，切勿將其連同家居廢物一起棄置，而應送至當地的相應回收點。

製造廠名稱/地址: Manufactured by Famidoc Technology Co., Ltd. (Address: No. 212 Yilong Road, Hexi Industrial Zone, Jinxia, Changan Town, Dongguan, Guangdong Province, 523853, P.R. China) for Kaz Europe Sàrl (Address: Place Chauderon 18, CH-1003 Lausanne, Switzerland)

藥商名稱: 集德醫材管理顧問有限公司

藥商地址: 新竹縣竹北市福德裏和平街8號10樓



