

BUSTER 700

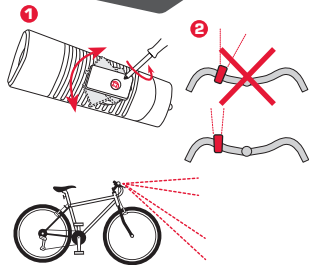

SCREW-BRACKET HALTERUNG/ SCREW-BRACKET MOUNT

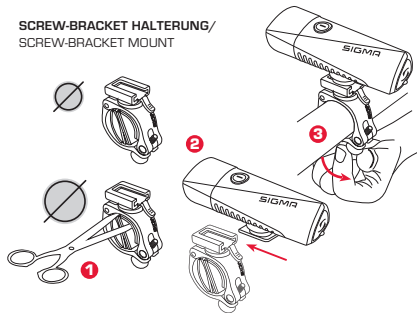

SILIKON HALTERUNG (OPTIONAL)/ SILICONE BRACKET (OPTIONAL)

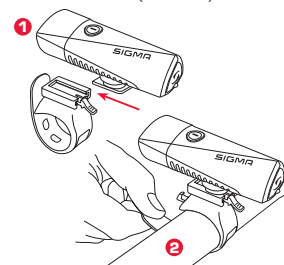

ADAPTER FÜR ACTION CAMERA HALTERUNG/ ADAPTER FOR ACTION CAMERA MOUNT

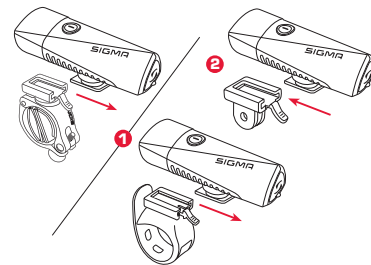

HELMET BRACKET / HELMHALTERUNG

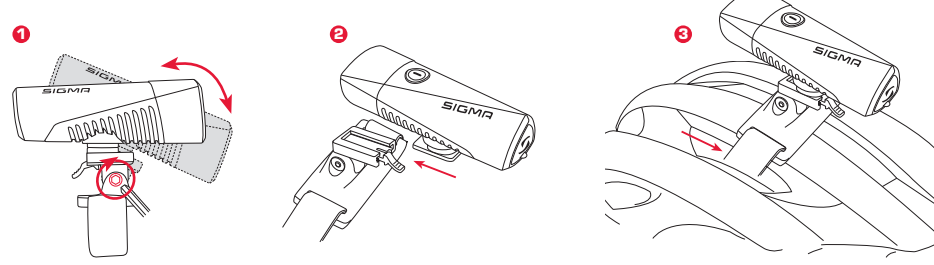

DRÜCKEN DER BEDIENTASTE ZUM WECHSELN DER MODI/ PRESS BUTTON TO SWITCH MODES

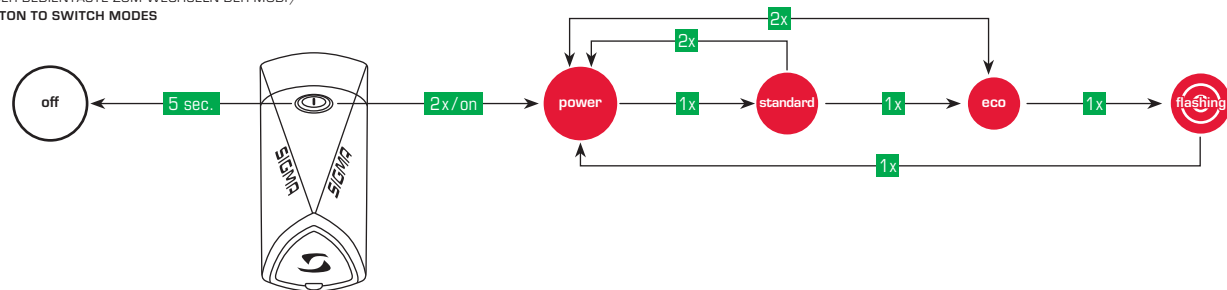

AKKUINDIKATOR / BATTERY CONTROL

- > 71%
- 70-31%
- < 30%

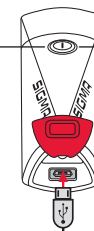

Micro
USB
Micro USB cable incl.

LADEVORGANG / CHARGING

- ca. 4 h

Achten Sie bitte darauf, dass die rotmarkierte Abdichtung stets korrekt verschlossen ist. / Please always keep the silicone plug closed after charging.



[charger
not incl.]

EU-Konformitätserklärung

Hiermit erklärt SIGMA-ELEKTRO GmbH, dass sich die BUSTER 700 in Übereinstimmung mit den grundlegenden Anforderungen und den anderen relevanten Vorschriften der Richtlinie 2014/30/EU und RoHS Directive 2011/65/EU befinden. Weitere Informationen: ce.sigmasport.com/buster700

CE Information

EN You can find the CE declaration at:
ce.sigmasport.com/buster700

DE Sie finden die Konformitäts-Erklärung unter folgendem Link:
ce.sigmasport.com/buster700

FR Vous trouverez la déclaration CE à l'adresse :
ce.sigmasport.com/buster700

IT La dichiarazione CE è disponibile all'indirizzo:
ce.sigmasport.com/buster700

ES Puede encontrar la declaración de conformidad CE en:
ce.sigmasport.com/buster700

PT Poderá encontrar a declaração CE em:
ce.sigmasport.com/buster700

NL U kunt de CE-certificering vinden op:
ce.sigmasport.com/buster700

PL Deklaracja CE znajduje się na stronie:
ce.sigmasport.com/buster700

CZ ES prohlášení najdete na adrese:
ce.sigmasport.com/buster700

DK Du kan finde EF-overensstemmelseserklæringen på:
ce.sigmasport.com/buster700

EU-Declaration of Conformity

SIGMA-ELEKTRO GmbH hereby declares that the BUSTER 700 comply with the fundamental requirements and other relevant regulations of Directive 2014/30/EU and RoHS Directive 2011/65/EU. For further information see: ce.sigmasport.com/buster700

FI CE-vakuutus on luettavissa osoitteessa:
ce.sigmasport.com/buster700

NO Du finner CE-deklarasjonen under:
ce.sigmasport.com/buster700

SE Du kan hitta CE-deklarationen under
ce.sigmasport.com/buster700

RU Декларацию о соответствии нормам ЕС Вы можете найти по адресу: ce.sigmasport.com/buster700

HU A CE megfelelőségi tanúsítvány a ce.sigmasport.com/buster700 oldalon található.

TR AT uygunluk beyanını ce.sigmasport.com/buster700 adresinde bulabilirsiniz.

RO Declarația de conformitate CE poate fi găsită la: ce.sigmasport.com/buster700

BG CE декларацията можете да намерите на: ce.sigmasport.com/buster700

SI Izjavo CE najdete na ce.sigmasport.com/buster700

SK ES vyhlásenie nájdete na adrese: ce.sigmasport.com/buster700

ZUBEHÖR / ACCESSORIES

Art.-Nr. 18552

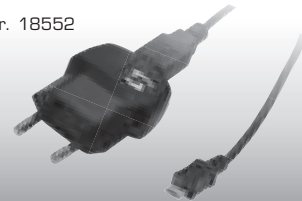

LADEGERÄT + MICRO USB KABEL
CHARGER + CHARGING CABLE MICRO-USB

ZUBEHÖR / ACCESSORIES

Art.-Nr. 00467



HELMET BRACKET
HELMHALTERUNG

ZUBEHÖR / ACCESSORIES

Art.-Nr. 00145



SILIKON HALTERUNG
SILICONE BRACKET

ZUBEHÖR / ACCESSORIES

Art.-Nr. 20501



USB-LADEGERÄT
USB CHARGER

LIGHTING SYSTEMS TOPLINE



BUSTER 700

SIGMA-ELEKTRO GmbH
Dr.-Julius-Leber-Strasse 15
D-67433 Neustadt / Weinstraße

SIGMA SPORT USA
1860B Dean St.
St. Charles, IL 60174, U.S.A.

SIGMA-ELEKTRO (Hong Kong) Ltd
Room 2010, 20/F, No.1 Hung To Road,
Kwun Tong, Kowloon, Hong Kong



189700/1