

TP-LINK®

Archer MR200

User Guide

AC750 Wireless Dual Band
4G LTE Router

Contents

About This Guide	1
Chapter 1. Get to Know About Your 4G LTE Router	2
1. 1. Product Overview	3
1. 2. Main Features	4
1. 3. Product Appearance	5
1. 3. 1.Top View	5
1. 3. 2.The Back Panel	6
Chapter 2. Connect the Hardware	8
2. 1. Requirements for Operation	9
2. 2. Position Your 4G LTE Router	9
2. 3. Connect Your 4G LTE Router	9
Chapter 3. Log into Your 4G LTE Router	12
Chapter 4. Set Up Internet Connections	14
4. 1. Use Quick Setup Wizard	15
4. 2. Create a Connection Profile	15
4. 3. Test Internet Connectivity	17
Chapter 5. Bandwidth Control	18
Chapter 6. Network Security	22
6. 1. MAC Filtering	23
6. 2. Access Control	24
6. 3. IP & MAC Binding	26
Chapter 7. Parental Controls	28
Chapter 8. SMS	32
8. 1. View Messages	33
8. 2. Edit and Send a New Message	33

8.3.	View Sent Messages	34
8.4.	View Drafts	34
8.5.	SMS Settings	35

Chapter 9. Guest Network 36

9.1.	Create a Network for Guests	37
9.2.	Customize Guest Network Options.....	37

Chapter 10.NAT Forwarding 39

10.1.	Share Local Resources in the Internet by Virtual Server.....	40
10.2.	Open Ports Dynamically by Port Triggering.....	41
10.3.	Make Applications Free from Port Restriction by DMZ	42
10.4.	Make Xbox Online Games Run Smoothly by UPnP	43

Chapter 11.Specify Your Network Settings 45

11.1.	PIN Management.....	46
11.2.	Data Settings.....	47
11.3.	LAN Settings	48
	11.3.1.Change the LAN IP Address	48
	11.3.2.Use the 4G LTE Router as a DHCP Server	48
	11.3.3.Reserve LAN IP Addresses	49
11.4.	Wireless Settings	50
	11.4.1.Specify Basic Wireless Settings.....	50
	11.4.2.Use WPS for Wireless Connection.....	52
	11.4.3.Schedule Your Wireless Function	54
	11.4.4.View Wireless Information.....	55
	11.4.5.Advanced Wireless Settings	56
11.5.	Set Up a Dynamic DNS Service Account.....	57
11.6.	Create Static Routes	58
11.7.	Set up a VPN Connection	60

Chapter 12.Administrate Your Network 65

12.1.	Set System Time.....	66
12.2.	Update the Firmware.....	67
12.3.	Back up and Restore Configuration Settings.....	67
12.4.	Change the Administrator Account	68
12.5.	Local Management.....	69





12. 6. Remote Management	69
12. 7. System Log	70
12. 8. Monitor the Internet Traffic Statistics	72
12. 9. CWMP Settings.....	73
12. 10. SNMP Settings	75
Appendix A: Specifications	77
Appendix B: Troubleshooting.....	79

About This Guide

This guide provides details of each function and shows how to configure the router appropriate to your needs. In addition to this guide, a Quick Installation Guide is also released with each TP-LINK router, you are suggested to configure your router for quick Internet setup by following the published Quick Installation Guide before you get started with a further configuration.

Conventions

In this guide the following conventions are used:

Convention	Description
modem router/ router	Stands for AC750 Wireless Dual Band 4G LTE Router without any explanation.
parameters	Parameters provided in the screenshots are just references for setting up the device, which may differ from the actual situation. You can set the parameters according to your demand.
screenshots	The demonstrated screenshots may look a little different from the actual web page of your device due to the various firmware versions. Please just configure your product based on the actual web page.
<i>Blue Italic</i>	Hyperlinks are in blue italic. You can click to redirect to a website or a specific section.
Blue	Contents to be emphasized and texts on the web page are in blue, including the menus, items, buttons, etc.
>	The menu structures to show the path to load the corresponding page. For example, Advanced > Wireless > MAC Filtering means the MAC Filtering function page is under the Wireless menu that is located in the Advanced tab.
 Note:	Ignoring this type of note might result in a malfunction or damage to the device.
 Tips:	Indicates important information that helps you make better use of your device.
symbols on the web page	<ul style="list-style-type: none"> Click to edit the corresponding entry. Click to delete the corresponding entry. Click to enable or disable the corresponding entry.

Chapter 1

Get to Know About Your 4G LTE Router

This chapter introduces what the router can do and shows its main features and appearance.

This chapter contains the following sections:

- *Product Overview*
- *Main Features*
- *Product Appearance*

1.1. Product Overview

What This Product Does

The AC750 Wireless Dual Band 4G LTE Router, Archer MR200, shares the latest generation 4G LTE network with multiple Wi-Fi devices, anywhere you want. It creates simultaneous dual band 802.11ac Wi-Fi, with speeds up to 300Mbps on 2.4GHz band and 433Mbps on 5GHz band. Also four Ethernet ports add your wired devices to the 4G LTE network.

802.11ac - The Next Generation of Wi-Fi

TP-LINK's Archer MR200 comes with the next generation Wi-Fi standard – 802.11ac, backward compatible with 802.11n and 3 times faster than wireless N speeds. With higher power efficiency and robust security, 802.11ac is the perfect way to accelerate a home multimedia network and solve congestion that multiple devices may cause.

750Mbps Concurrent Dual Band - More Bandwidth, Less Interference

With 433Mbps wireless speeds over the crystal clear 5GHz band and 300Mbps over the 2.4GHz band, Archer MR200 offers you the flexibility of two dedicated networks and ensures amazing wireless performance. Simple tasks such as sending e-mails or web browsing can be handled by the 2.4GHz band while bandwidth intensive tasks like online gaming or HD video streaming can be processed by the 5GHz band – all at the same time.

Broad Wi-Fi Coverage and Targeted Connection

Featuring two fixed external antennas and high power amplifiers, Archer MR200 is able to boost Wi-Fi coverage throughout your home. Advanced Beamforming technology enables Archer MR200 to focus Wi-Fi signal to connected devices, delivering a more targeted and highly efficient wireless connection.

Interchangeable LAN/WAN Port - Versatile Connectivity

The Archer MR200 supports 4G LTE or Ethernet WAN connections (EWAN), which allows users to have the flexibility of different Internet connections among LTE, cable or fiber modem using its SIM card slot and interchangeable LAN/WAN port. This unique feature makes it easier when users need to change to fiber or cable services when necessary.

Guest Network

Guest Network Access provides secure Wi-Fi access for guests sharing your home or office network in a controlled manner without exposing private Wi-Fi access codes or other personal data.

IPv6 Supported

Archer MR200 supports IPv6, which is the foundation of the next generation of the Internet and enables a range of new services and improved user experience.

1.2. Main Features

- Supports 4G/3G/2G network

LTE: Cat4

FDD-LTE: 800MHz (Band20)/ 900MHz (Band8)/ 1800MHz (Band3)/ 2100MHz (Band1)/ 2600MHz (Band7)

TDD-LTE: 2300MHz (Band40)/ 2600MHz (Band38)

DC-HSPA+/ HSPA+/HSPA/UMTS: 900/2100MHz

EDGE/GPRS/GSM: 850/900/1800/1900MHz

- 4G LTE supported with up to 150Mbps downloads and 50Mbps uploads speeds (FDD-LTE)
- Supports 802.11ac - The next generation of Wi-Fi, compatible with 802.11n
- Simultaneous Dual Band, with maximum speed up to 300Mbps over 2.4GHz and 433Mbps over 5GHz
- Ethernet WAN (EWAN) offers another broadband connectivity option for connecting DSL, cable or fiber modems
- Guest Network Access provides secure Wi-Fi access for guests sharing your home or office network
- Parental Controls allows parents or administrators to establish restricted access policies for children or staff
- IP-based Bandwidth Control makes it easier for you to manage the bandwidth of devices connected to the router
- Easy wireless security encryption at a push of the WPS button
- IPv6 supported, meeting the demands for the next generation of Internet
- Wi-Fi On/Off Button allows users to turn their wireless radio on or off
- Easy one-touch WPA wireless security encryption with the WPS button
- WPA-PSK/WPA2-PSK encryptions provide user networks with active defense against security threats
- Easy Setup Assistant with multi-language support provides a quick & hassle free installation process
- Supports up to 10 IPSecVPN tunnels simultaneously, offering you the most economical way to connect to the company's central network securely
- Wireless Schedule lets you to turn the Wi-Fi radio on or off based on a preset timetable
- SPI and NAT firewall protects end-user devices from potential attacks across the Internet





1.3. Product Appearance

1.3.1. Top View





The router's LEDs are located on the top panel (view from top to bottom). You can check the router's working status by following the LED Explanation table.

LED Explanation

Name	Status	Indication
 Power	On	System initialization complete.
	Flashing	System initializing or firmware upgrading is in process. Do not disconnect or power off the router.
	Off	Power is off. Please ensure that the power adapter is connected correctly.
 Internet	On	Internet connection is available.
	Off	No Internet connection. Please refer to Note 1 for troubleshooting.
4G 4G	On	The router is using the 4G network.
	Off	The router is using another network other than the 4G network.
 Wireless	On	At least one wireless radio band (2.4 GHz or 5 GHz) is enabled.
	Off	The wireless radio band is disabled.
 LAN	On	At least one LAN port is connected.
	Off	No LAN port is connected.

LED Explanation

Name	Status	Indication
 WPS	On/ Off	The LED stays on for no more than 5 minutes when a WPS connection is established, then turns off.
	Flashing	WPS connection is in progress. This may take up to 2 minutes.
 Signal Strength	On	Indicates the mobile Internet signal strength the router receives in the current location. More lit bars indicates a better signal strength.
	Off	No signal. Please refer to Note 2 for troubleshooting.

Note:

1. If the Internet LED is off, please check your Internet connection first. Refer to [Connect Your 4G LTE Router](#) for more information about how to make Internet connection correctly. If you have already made a right connection, please contact your ISP to make sure your Internet service is available now.
2. If the Signal Strength LED is off, please check your Internet LED first. If your Internet LED is also off, please refer to [Note 1](#). If your Internet LED is on, please relocate the router to a location that receives a strong mobile Internet signal, such as near a window.

1.3.2. The Back Panel



The router's back panel shows the connection ports, buttons and antennas (view from left to right). Refer to the following for detailed instructions.

Item	Description
POWER	For connecting the router to power socket via the provided power adapter.
POWER ON/OFF	The switch for the power. Press it to power on or off the router..
LAN1, LAN2, LAN3, LAN4/WAN	For connecting to your PCs or other Ethernet network devices. In wireless router mode, the LAN4/WAN port is used for connecting to a Cable/FTTH/VDSL/ADSL device.

Item	Description
WPS/RESET	The switch for the WPS and RESET function. RESET: There are two ways to reset the router to its factory defaults. Method one: With the router powered on, use a pin to press and hold the RESET button until the Power LED starts flashing. And the router will reboot to its factory default settings. Method two: Restore the default setting from Backup & Restore of the router's Web-based Management page.
Wi-Fi ON/OFF	For turning on/off the Wi-Fi function..
SIM Card Slot	For holding the SIM card.
Antennas	Used for data sessions over LTE. Upright them for the best mobile Internet signal.

Chapter 2

Connect the Hardware

This chapter contains the following sections:

- *Requirements for Operation*
- *Position Your 4G LTE Router*
- *Connect Your 4G LTE Router*

2.1. Requirements for Operation

To connect and use the router for Internet sharing, you must have the following:

- SIM card with Internet access enabled.
- PCs with an active Ethernet Adapter and an Ethernet cable with RJ45 connectors.
- TCP/IP protocol on each PC.
- Web browser, such as Microsoft Internet Explorer, Mozilla Firefox and Apple Safari.

2.2. Position Your 4G LTE Router

With the router, you can access your network from anywhere within the wireless network coverage. However, the wireless signal strength and coverage varies depending on the actual environment where your router is in. Many obstacles may limit the range of the wireless signal, for example, concrete structures, thickness and number of walls.

For your security and best Wi-Fi performance, please:

- Do not locate the router in the place where it will be exposed to moisture or excessive heat.
- Keep away from strong electromagnetic radiation source and electromagnetic-sensitive devices.
- Place the router in a location where it can be connected to the various devices as well as to a power source.
- Place the router in a location where it can receive a strong mobile Internet signal.
- Make sure the cables and power cord are safely placed out of the way so they do not create a tripping hazard.

◆ **Tips:** The router can be placed on a shelf or desktop.

2.3. Connect Your 4G LTE Router

Follow the steps below to connect your router.

1. Connect the power adapter. The power source shall be near the device and shall be easily accessible.

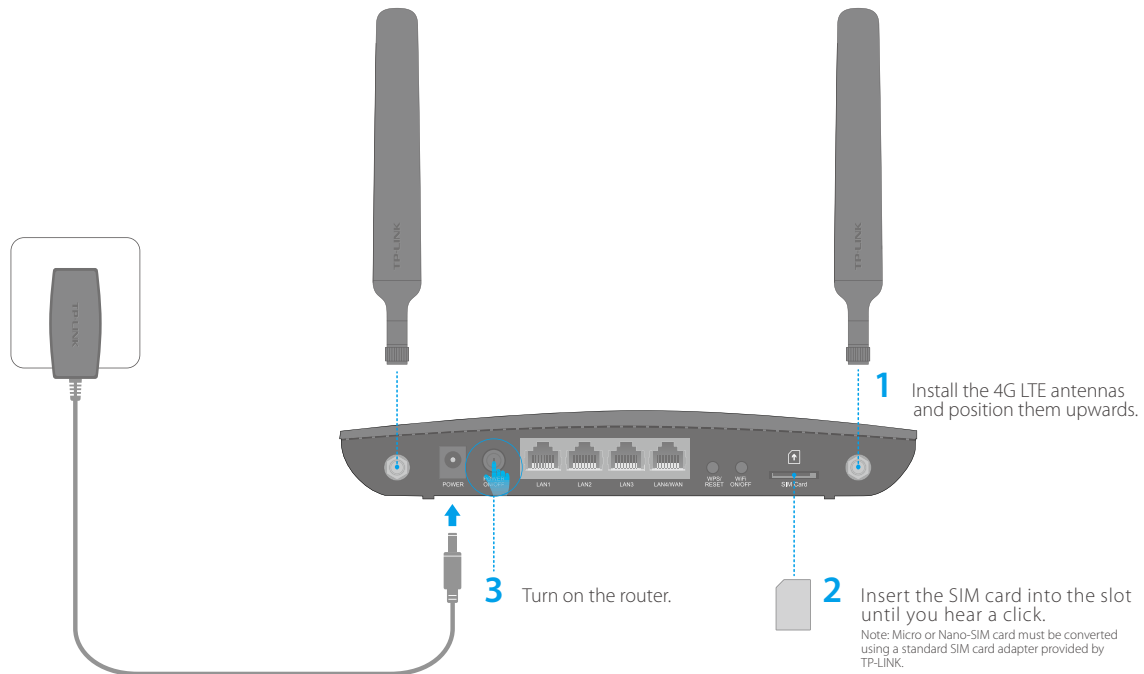

2. Connect your computer to the router.

Method 1: Wired

Connect your computer's Ethernet port to one of the LAN ports on Archer MR200 via an Ethernet cable.

Method 2: Wirelessly

Use the default SSID (Wireless Network Name) and Wireless Password printed on the product label of the router to connect wirelessly.

Method 3: Use the WPS button

Wireless devices that support WPS, including Android phones, tablets, most USB network cards, can be connected to your router through this method. (WPS is not supported by iOS devices.)

■ Note:

The WPS function cannot be configured if the wireless function of the router is disabled. Also, the WPS function will be disabled if your wireless encryption is WEP. Please make sure the wireless function is enabled and is configured with the appropriate encryption before configuring the WPS.

- 1) Tap the WPS icon on the device's screen.
- 2) Immediately press the WPS button on your router.
- 3) The WPS LED flashes for about 2 minutes during the WPS process.
- 4) When the WPS LED is on, the client device has successfully connected to the router.

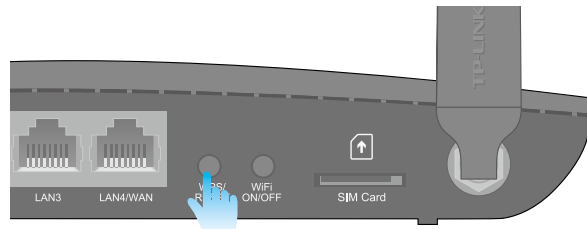

Chapter 3

Log into Your 4G LTE Router

With a Web-based management page, it is easy to configure and manage the Archer MR200 AC750 Wireless Dual Band 4G LTE Router. The Web-based management page can be used on any Windows, Macintosh or UNIX OS with a Web browser, such as Microsoft Internet Explorer, Mozilla Firefox or Apple Safari.

Follow the steps below to log into your router.

1. If the TCP/IP Protocol on your computer is set to the static (fixed) IP address, you need to change it to obtain an IP address automatically. Refer to [Appendix B: Troubleshooting](#) to configure your computer.
2. Launch a web browser and type in <http://tplinkmodem.net> or <http://192.168.1.1>. Set a strong password using 1-15 characters and click [Save](#).

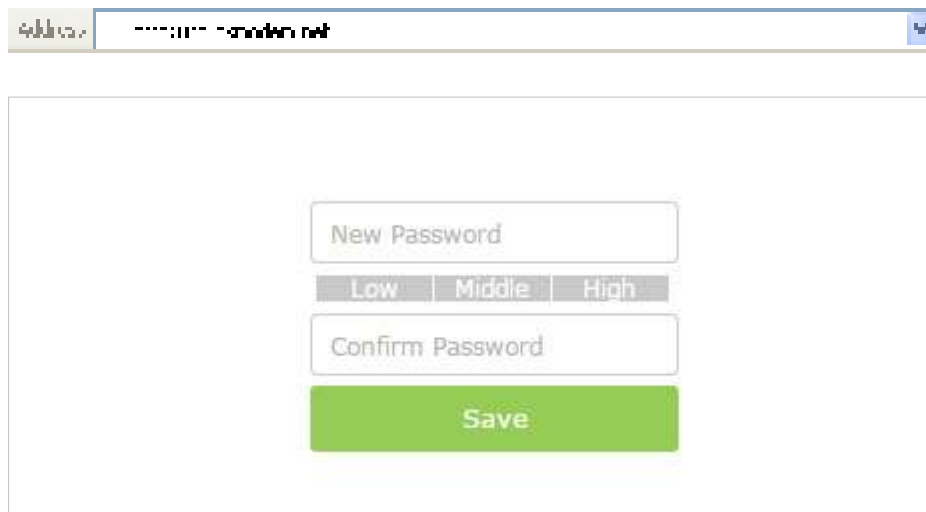

The screenshot shows a web browser window with the address bar containing "http://tplinkmodem.net". Below the address bar, there is a form for creating a new password. It includes a text input field labeled "New Password", a strength indicator with three buttons labeled "Low", "Middle", and "High", another text input field labeled "Confirm Password", and a green "Save" button.

3. Enter the password you set and click [Log in](#).

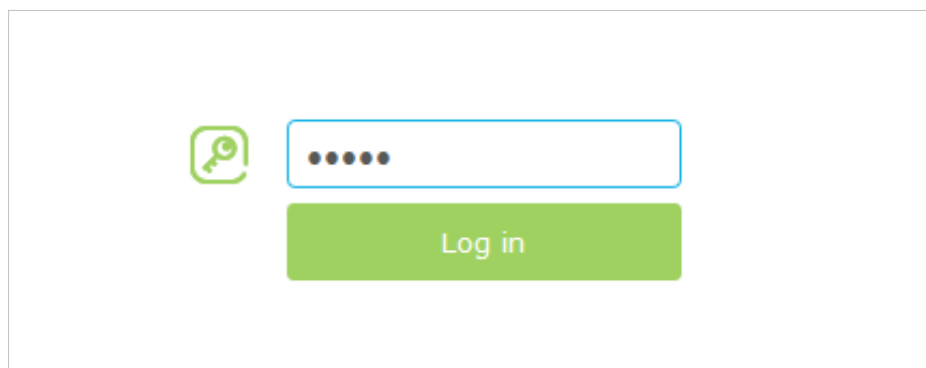

The screenshot shows the login page of the web browser. It features a key icon on the left, a password input field with five dots, and a green "Log in" button.

■ **Note:** For subsequent logins, use your password that you have created.

Chapter 4

Set Up Internet Connections

This chapter introduces how to connect your router to the Internet. The router is equipped with a web-based Quick Setup wizard. It has many ISP information built in, automates many of the steps and verifies that those steps have been successfully completed. Furthermore, you can set up IPv6 connection if your ISP provides IPv6 service.

This chapter includes the following sections:

- [*Use Quick Setup Wizard*](#)
- [*Create a Connection Profile*](#)
- [*Test Internet Connectivity*](#)

4.1. Use Quick Setup Wizard

To set up your router with several easy steps quickly:

1. Visit <http://tplinkmodem.net>, and log in with the password you set for the router.
2. Click **Quick Setup**, confirm the parameters with the information provided by your ISP and click **Next**.

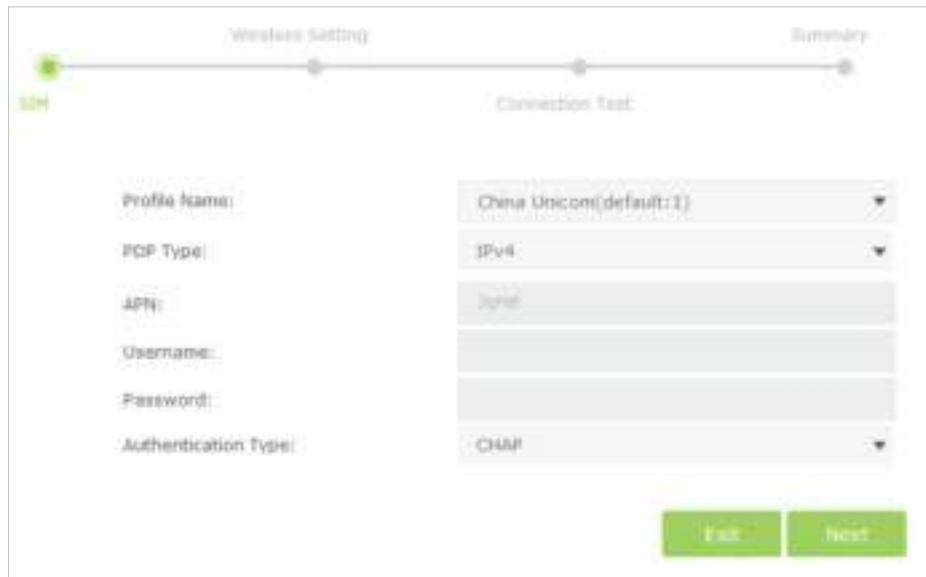

The screenshot shows the 'Quick Setup Wizard' interface. At the top, there is a progress bar with four steps: 'SIM' (highlighted in green), 'Wireless Setting', 'Connection Test', and 'Summary'. Below the progress bar, the 'SIM' section is active, displaying the following fields:

Profile Name:	China Unicom(default:1)
IP Type:	IPv4
APN:	3gnet
Username:	
Password:	
Authentication Type:	CHAP

At the bottom right of the form, there are two green buttons: 'Exit' and 'Next'.

■ **Note:**

Quick Setup is not available if your SIM card is locked. Unlock your SIM card according to the prompt.

3. Follow the on-screen instructions to complete the setup.

■ **Note:**

1. During the quick setup process, you can change the preset wireless network name (SSID) and wireless password. Once done, all your wireless devices must use the new SSID and password to connect to the router.
2. The router supports two operation modes, 3G/4G Router Mode and Wireless Router mode. If you already have a modem or your Internet comes via an Ethernet cable from the wall, you can set up the router as a regular wireless router to share the Internet. Refer to [Appendix B: Troubleshooting](#) for details.

4.2. Create a Connection Profile

If your ISP settings are not detected by the router, you can create an Internet connection profile by following the steps below:

1. Visit <http://tplinkmodem.net>, and log in with the password you set for the router.
2. Go to **Advanced** > **Network** > **Internet** page.



3. Click [Create Profile](#).
4. Specify the [Profile Name](#), [Username](#) and [Password](#). Select the [PDP Type](#), [APN Type](#) and [Authentication Type](#) according to your ISP.

5. Click [OK](#) to make the settings effective and the new profile will be used to set up a new connection.

Tips:

1. You can view all Internet connections or edit connections that are set up manually on this page.
2. You can change the [Network Mode](#) to [4G Only](#) or [3G Only](#) according to your needs.

4.3. Test Internet Connectivity

After manually set up the Internet connection, you need to know the Internet connectivity. The router provides a diagnostic tool to help you locate the malfunction.

1. Visit <http://tplinkmodem.net>, and log in with the password you set for the router.
2. Go to [Advanced](#) > [System Tools](#) > [Diagnostics](#) page.

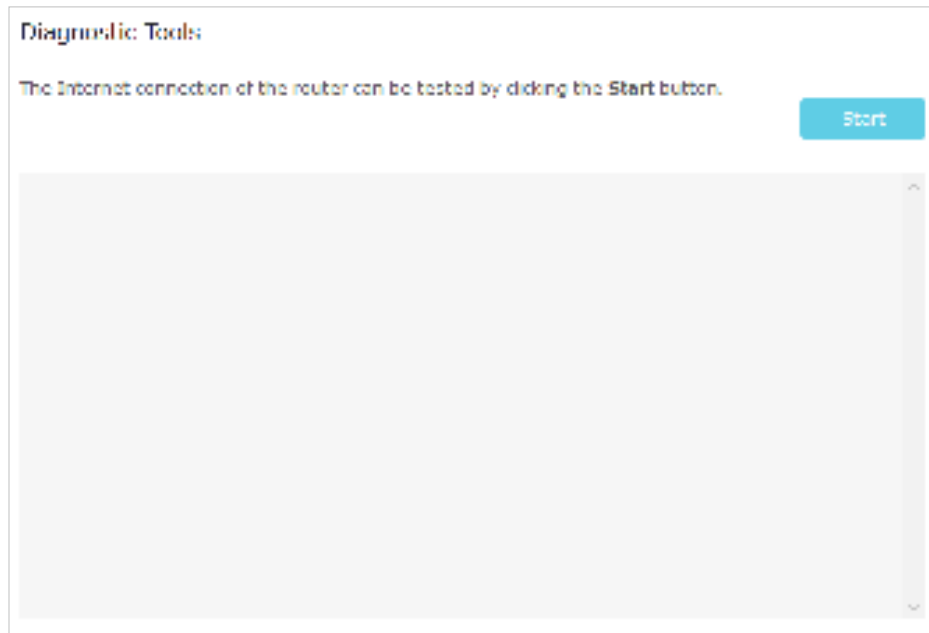

3. Click [Start](#) to test the Internet connectivity and you will see the test result in the gray box.

Chapter 5

Bandwidth Control

The Bandwidth Control feature is used to fully utilize your limited bandwidth and optimize the load respectively. With this feature enabled, you can assign a specific minimum or maximum bandwidth for each computer, thus minimizing the impact caused when the connection is under heavy load.

I want to: Use an independent bandwidth and enjoy a good Internet experience without being affected by other users who are sharing the same router.

For example, my roommate and I share 512Kbps Upstream Bandwidth and 4Mbps Downstream Bandwidth via this router, she likes to watch live show and play online games, which may take up much bandwidth. I don't want to be affected, so we agree to equally distribute the bandwidth. The IP addresses of her computer and my computer are 192.168.1.101 and 192.168.1.110.

Tips: To use the bandwidth control feature, you'd better set static IP Address on each computer to be controlled or configure Address reservation on the router in order to manage it easily. About how to configure address reservation, please refer to [Reserve LAN IP Addresses](#).

How can I do that?

1. Visit <http://tplinkmodem.net>, and log in with the password you set for the router.
2. Go to [Advanced](#) > [Bandwidth Control](#) page.

Bandwidth Control

Bandwidth Control: Enable

Total Upstream Bandwidth: kbps

Total Downstream Bandwidth: kbps

Save

Controlling Rules

+ Add - Delete

<input type="checkbox"/>	Description	Priority	Up (min/max)	Down (min/max)	Enable	Modify
--	--	--	--	--	--	--

3. Enable [Bandwidth Control](#).
4. Enter the [Total Upstream Bandwidth](#) and the [Total Downstream Bandwidth](#) given by your ISP. (1Mbps=1024kbps). Click [Save](#) to save the settings.
5. Click [Add](#) to add controlling rules for each computer respectively.

The screenshot shows the 'Controlling Rules' configuration window. At the top, there are 'Add' and 'Delete' buttons. Below is a table with the following columns: Description, Priority, Up (min/max), Down (min/max), Enable, and Modify. The table is currently empty. Below the table is a form with the following fields:

- IP Range: 192.168.1.101 to 192.168.1.101
- Port Range: 1 to 65535
- Protocol: ALL
- Priority: 5 (1 means the highest priority)
- Upstream: 250 to 500
- Downstream: 2000 to 4000

At the bottom of the form, there is a checkbox labeled 'Enable this entry' and two buttons: 'Cancel' and 'OK'.

- 1) **IP Range:** Enter the IP address. The field can be single IP address or IP address range according to your demands. When you enter a single IP address, the computer with this IP address will get independent given bandwidth. When you enter an IP address range, all computers in the range will share the given bandwidth.
 - 2) **Port Range:** Keep the default settings. The default port range of TCP protocol or UDP protocol is from 1 to 65535.
 - 3) **Protocol:** Keep the default setting. Or you can choose the TCP protocol or UDP protocol or both of them.
 - 4) **Priority:** Keep the default setting. You can change the value if you want to first guarantee the bandwidth for one computer. The smaller value has the higher priority.
 - 5) **Upstream/Downstream:** Enter the bandwidth according to your division.
 - 6) Check to enable this entry and click **OK** to save the settings.
6. Follow the steps above to add a rule for the other client device. And then you will get the following table.

Controlling Rules

 Add  Delete

<input type="checkbox"/>	Description	Priority	Up(min/max)	Down(min/max)	Enable	Modify
<input type="checkbox"/>	192.168.1.110	5	250/500 kbps	2000/4000 kbps		 
<input type="checkbox"/>	192.168.1.101	5	250/500 kbps	2000/4000 kbps		 

Done!

Now you and your roommate have an independent bandwidth.

Chapter 6

Network Security

This chapter guides you on how to protect your home network from unauthorized users by implementing these three network security functions. You can block or allow specific client devices to access your wireless network using MAC Filtering, or using Access Control for wired and wireless networks, or you can prevent ARP spoofing and ARP attacks using IP & MAC Binding.

- *MAC Filtering*
- *Access Control*
- *IP & MAC Binding*

6.1. MAC Filtering

This function exploits the uniqueness of the MAC (Medium Access Control) address, a unique 12-digit hexadecimal address (for example, D8:5D:4C:B4:46:EA) of every network device, to determine if the device can or cannot access your wireless network.

I want to: Prevent unauthorized users from accessing my wireless network by utilizing the network device's MAC address.

For example, I have a computer that is connected to my wireless network. Now, an unknown device (an intruder) is also using my wireless network, which affects my Internet speed. I would like to control my wireless network with the following capabilities:

- My computer is always allowed to access the wireless network.
- The unknown device is not allowed to access the wireless network.
- I don't have to keep changing my wireless password as often.

How can I do that?

1. Visit <http://tplinkmodem.net>, and log in with the password you set for the router.
2. Go to [Advanced](#) > [Wireless](#) > [MAC Filtering](#) and enable [Wireless MAC Filtering](#).

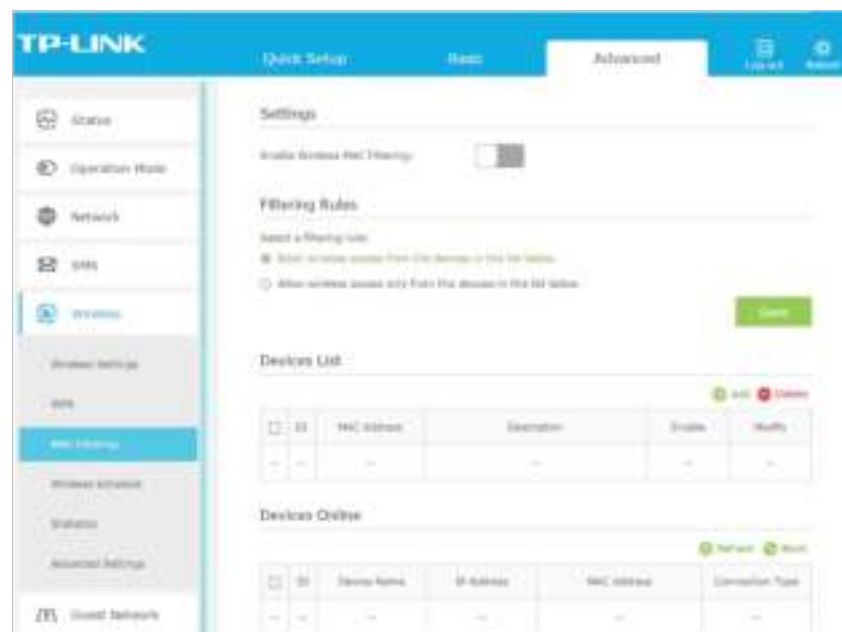

3. Select the filtering rule to either block (recommended) or allow the device(s) in the list.

To block specific device(s)

- 1) Select [Block wireless access from the devices in the list below](#) and click [Save](#).
- 2) Select the device(s) to be blocked in the [Devices Online](#) table.
- 3) Click [Block](#) above the [Devices Online](#) table. The selected devices will be added to [Devices List](#) automatically.

To allow specific device(s)

- 1) Select [Allow wireless access only from the devices in the list below](#) and click [Save](#).
- 2) Click [Add](#).

The screenshot shows a web interface titled "Devices List". At the top right, there are "Add" and "Delete" buttons. Below is a table with the following columns: ID, MAC Address, Description, Enable, and Modify. The table is currently empty. Below the table, there are two input fields: "MAC Address" with the value "14:CC:20:88:A0:D3" and "Description" with the value "My PC". There is a checkbox labeled "Enable this Entry" which is checked. At the bottom right, there are "Cancel" and "OK" buttons.

- 3) Enter the [MAC Address](#) (You can copy and paste the [MAC Address](#) from [Devices Online](#) list if the device is connected to your wireless network).
- 4) Enter the [Description](#) of the device.
- 5) Select the checkbox to enable this entry, and click [OK](#).

Done!

Now MAC Filtering is implemented to protect your wireless network.

6.2. Access Control

Access Control is used to block or allow specific client devices to access your network (via wired or wireless) based on a list of blocked devices (Blacklist) or a list of allowed devices (Whitelist).

I want to:

Block or allow specific client devices to access my network (via wired or wireless).

How can I do that?

1. Visit <http://tplinkmodem.net>, and log in with the password you set for the router.

- Go to [Advanced](#) > [Security](#) > [Access Control](#) and enable [Access Control](#).

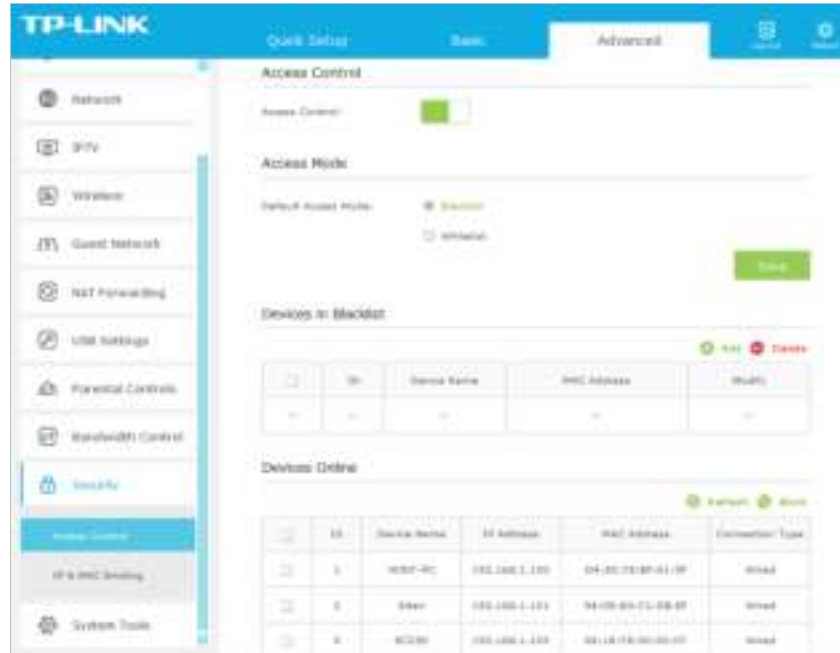

- Select the access mode to either block (recommended) or allow the device(s) in the list.

To block specific device(s)

- Select [Blacklist](#) and click [Save](#).
- Select the device(s) to be blocked in the [Devices Online](#) table.
- Click [Block](#) above the [Devices Online](#) table. The selected devices will be added to [Devices in Blacklist](#) automatically.

To allow specific device(s)

- Select [Whitelist](#) and click [Save](#).
- Click [Add](#).



- 3) Enter the **Device Name** and **MAC Address** (You can copy and paste the information from **Devices Online** table if the device is connected to your network).
- 4) Click **OK**.

Done!

Now you can block or allow specific client devices to access your network (via wired or wireless) using the **Blacklist** or **Whitelist**.

6.3. IP & MAC Binding

IP & MAC Binding, namely, ARP (Address Resolution Protocol) Binding, is used to bind network device's IP address to its MAC address. This will prevent ARP spoofing and other ARP attacks by denying network access to a device with matching IP address in the Binding list, but unrecognized MAC address.

I want to:

Prevent ARP spoofing and ARP attacks.

How can I do that?

1. Visit <http://tplinkmodem.net>, and log in with the password you set for the router.
2. Go to **Advanced > Security > IP & MAC Binding** and enable **IP & MAC Binding**.

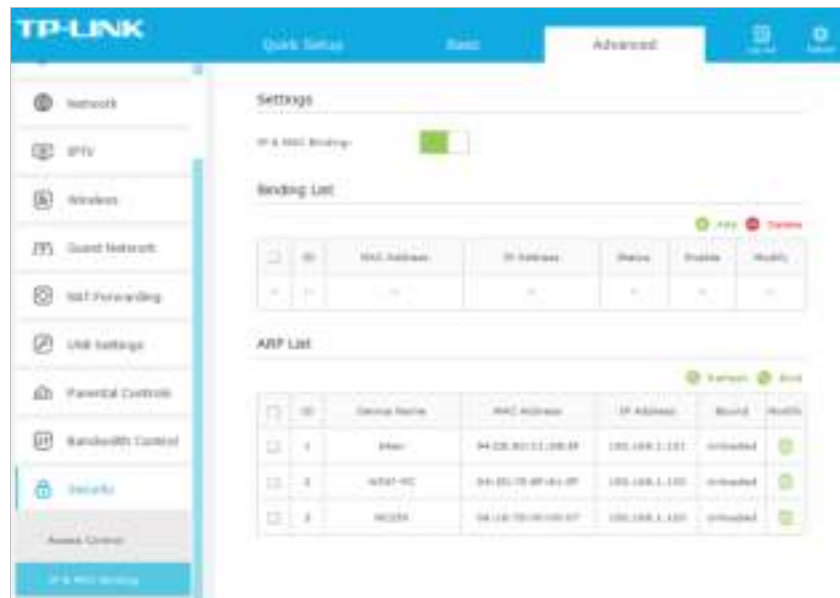

3. Bind your device(s) according to your needs.

To bind the connected device(s)

- 1) Select the device(s) to be bound in the **ARP List**.
- 2) Click **Bind** to add to the **Binding List**.

To bind the unconnected device

1) Click **Add**.



The screenshot shows a web interface titled "Binding List". At the top right, there are "Add" and "Delete" buttons. Below is a table with the following columns: ID, MAC Address, IP Address, Status, Enable, and Modify. The table is currently empty. Below the table, there is a form for adding a new entry. It includes two input fields: "MAC Address" with the value "50:ES:48:1E:06:80" and "IP Address" with the value "192.168.1.200". There is an "Enable" checkbox that is checked. At the bottom right of the form are "Cancel" and "OK" buttons.

2) Enter the **MAC address** and **IP address** that you want to bind.

3) Select the checkbox to enable the entry and click **OK**.

Done!

Now you don't need to worry about ARP spoofing and ARP attacks.

Chapter 7

Parental Controls

This function allows you to block inappropriate, explicit and malicious websites, and control access to specified websites at specified time.

I want to:

Control the times of day my children or other home network users are allowed to access the Internet and even types of websites they can visit.

For example, I want to allow my children's devices (e.g. a computer or a tablet) to access only www.tp-link.com and Wikipedia.org, from 18:00 (6PM) to 22:00 (10PM) on weekdays and not other times.

How can I do that?

1. Visit <http://tplinkmodem.net>, and log in with the password you set for the router.
2. Go to [Basic](#) or [Advanced](#) > [Parental Controls](#) and enable [Parental Controls](#).

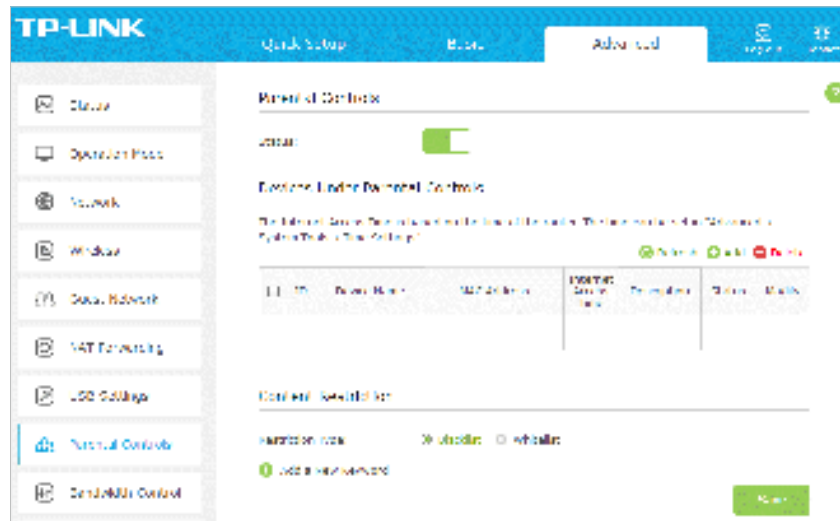

3. Click [Add](#).

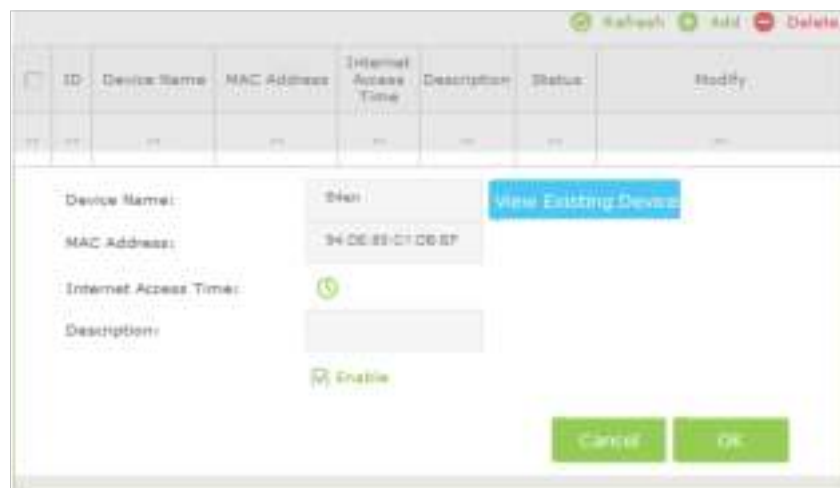

4. Click [View Existing Devices](#), and select the device to be controlled. Or, enter the [Device Name](#) and [MAC Address](#) manually.
5. Click the  icon to set the Internet Access Time. Drag the cursor over the appropriate cell(s) and click [OK](#).



6. Enter a [Description](#) for the entry.
7. Select the checkbox to enable this entry and click [OK](#).
8. Select the restriction type.
 - 1) With [Blacklist](#) selected, the controlled devices cannot access any websites containing the specified keywords during the Internet Access Time period.
 - 2) With [Whitelist](#) selected, the controlled devices can only access websites containing the specified keywords during the Internet Access Time period.



9. Click [Add a New Keyword](#). You can add up to 200 keywords for both Blacklist and Whitelist. Below are some sample entries to allow access.
 - 1) Enter a web address (e.g. www.tp-link.com) or a web address keyword (e.g. wikipedia) to only allow or block access to the websites containing that keyword.
 - 2) Specify the domain suffix (eg. [.edu](#) or [.org](#)) to allow access only to the websites with that suffix.
 - 3) If you wish to block all Internet browsing access, do not add any keyword to the [Whitelist](#).
10. Enter the keywords or websites you want to add and click [Save](#).

Done!

Now you can control your children's Internet access according to your needs.

Chapter 8

SMS

This chapter introduces how to use the SMS functions to view and write messages, keep drafts and specify the message center number. You can easily monitor your data usage by sending a message to your carrier.

This chapter includes the following sections:

- [*View Messages*](#)
- [*Edit and Send a New Message*](#)
- [*View Sent Messages*](#)
- [*View Drafts*](#)
- [*SMS Settings*](#)

8.1. View Messages

1. Visit <http://tplinkmodem.net>, and log in with the password you set for the router.
1. Go to [Advanced](#) > [SMS](#) > [Inbox](#) page.

Status	Phone Number	Message	Received	Modify
<input checked="" type="checkbox"/>	10086	[Message Content]	2015-07-30 09:46:37	<input checked="" type="checkbox"/> <input type="checkbox"/>

2. Click the or icon to unfold and read the content of the message.

◆ Tips:

indicates the message is read, while indicates the message is unread.

8.2. Edit and Send a New Message

1. Visit <http://tplinkmodem.net>, and log in with the password you set for the router.
1. Go to [Advanced](#) > [SMS](#) > [New Message](#) page.

New Message

Phone Number:

Message: (158/1)

2. Enter the receiver's phone number in the [Phone Number](#) field.
3. Enter your message in the [Message](#) field.

◆ **Tips:**

You can enter up to 160 letters or numbers, and any exceeding characters will be sent in the next message. You can send up to 5 messages each time.

4. Click [Send](#) to send the message or click [Save](#) to save the message to the Drafts.

8.3. View Sent Messages

1. Visit <http://tplinkmodem.net>, and log in with the password you set for the router.
2. Go to [Advanced](#) > [SMS](#) > [Outbox](#) page. All the messages you sent are listed in the [Outbox](#) table.

Outbox				
Refresh Delete				
<input type="checkbox"/>	Phone Number	Message	Sent	Modify
<input type="checkbox"/>	10086	CALL	2015 07 30 01:40:33	Edit Delete
< 1 >				

◆ **Tips:**

You can click  to edit and forward the message.

8.4. View Drafts

1. Visit <http://tplinkmodem.net>, and log in with the password you set for the router.
2. Go to [Advanced](#) > [SMS](#) > [Drafts](#) page. All the unsent messages are listed in the [Drafts](#) table.

Drafts			
Refresh Delete			
<input type="checkbox"/>	Phone Number	Message	Modify
<input type="checkbox"/>	10086	CALL	Edit Delete
< 1 >			

◆ **Tips:**

You can click  to edit and forward the message.

8.5. SMS Settings

SMS Settings allows you to configure the Message Center. When the Message Center is enabled, you can change the Message Center Number via which messages will be sent. It is not recommended to change it for a wrong message center number will affect the SMS function of the router.

1. Visit <http://tplinkmodem.net>, and log in with the password you set for the router.
2. Go to [Advanced](#) > [SMS](#) > [SMS Settings](#) page and enable [Message Center](#).

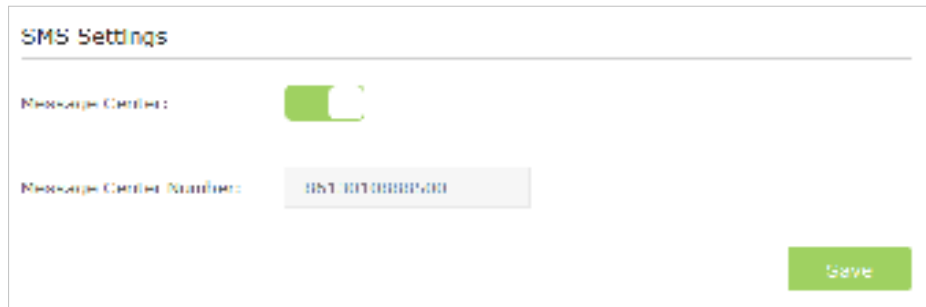

The screenshot shows the 'SMS Settings' configuration page. It includes a title bar, a 'Message Center' toggle switch (currently on), a 'Message Center Number' text input field (containing '087 010888500'), and a 'Save' button.

3. The [Message Center Number](#) is auto-populated. Change it according to your needs.

Chapter 9

Guest Network

This function allows you to provide Wi-Fi access for guests without disclosing your main network. When you have guests in your house, apartment, or workplace, you can create a guest network for them. In addition, you can customize guest network options to ensure network security, privacy, and fluency.

This chapter contains the following sections:

- [*Create a Network for Guests*](#)
- [*Customize Guest Network Options*](#)

9.1. Create a Network for Guests

1. Visit <http://tplinkmodem.net>, and log in with the password you set for the router.
2. Go to [Advanced](#) > [Guest Network](#). Locate the [Wireless Settings](#) section.
3. Create a 2.4GHz or 5GHz guest network according to your needs.

- 1) Enable [2.4GHz](#), [5GHz](#) or both wireless networks.

▀ Note:

Guest network and WDS cannot be enabled at the same time. If WDS was enabled, disable it at [Advanced](#) > [Wireless](#) > [Advanced Settings](#).

- 2) Customize the SSID. Don't select [Hide SSID](#) unless you want your guests to manually input the SSID for guest network access.
- 3) Set [Security](#) to [WPA/WPA2 Personal](#), keep the default [Version](#) and [Encryption](#) values, and customize your own password.

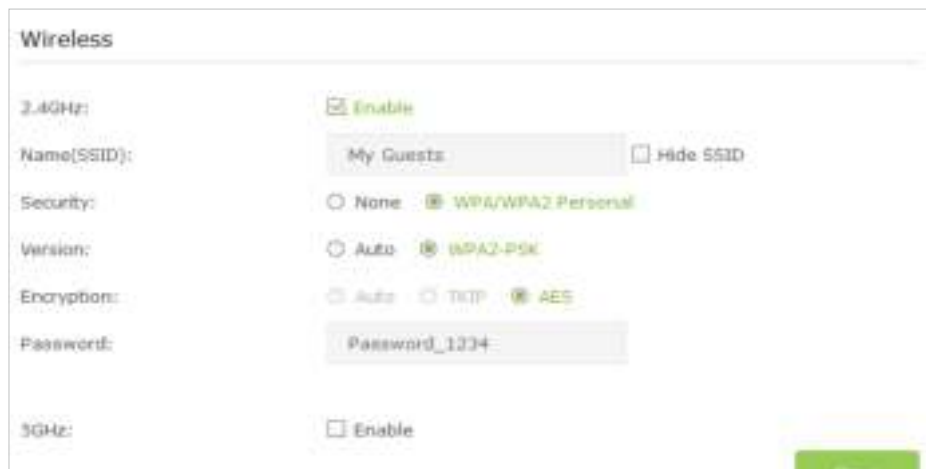

The screenshot shows the 'Wireless' settings page for a guest network. The '2.4GHz' section is active, with the 'Enable' checkbox checked. The 'Name(SSID)' field contains 'My Guests' and the 'Hide SSID' checkbox is unchecked. The 'Security' dropdown is set to 'WPA/WPA2 Personal'. The 'Version' dropdown is set to 'WPA2-PSK'. The 'Encryption' dropdown is set to 'AES'. The 'Password' field contains 'Password_1234'. The '5GHz' section has the 'Enable' checkbox unchecked.

4. Click [Save](#). Now your guests can access your guest network using the SSID and password you set!

◆ Tips:

To view guest network information, go to [Advanced](#) > [Status](#) and locate the [Guest Network](#) section.

9.2. Customize Guest Network Options

1. Visit <http://tplinkmodem.net>, and log in with the password you set for the router.
2. Go to [Advanced](#) > [Guest Network](#). Locate the [Settings](#) section.
3. Customize guest network options according to your needs.

- [Allow guests to see each other](#)

Select this checkbox if you want to allow the wireless clients on your guest network to communicate with each other via methods such as network neighbors, Samba, Ping, and FTP.

- [Allow guests to access my local network](#)

Select this checkbox if you want to allow the wireless clients on your guest network to communicate with the devices connected to your router's LAN ports or main network via methods such as network neighbors, Samba, Ping, and FTP.

- [Enable guest network bandwidth control](#)

Select this checkbox if you want to assign the upstream and downstream bandwidths for the guest network. This option is available only when [Bandwidth Control](#) is enabled on the [Advanced > Bandwidth Control](#) page.

4. Click [Save](#). Now you can ensure network security, privacy, and fluency!

💡 Tips:

To view guest network information, go to [Advanced > Status](#) and find the [Guest Network](#) section.

Chapter 10

NAT Forwarding

Router's NAT (Network Address Translation) feature makes the devices in the LAN use the same public IP address to communicate in the Internet, which protects the local network by hiding IP addresses of the devices. However, it also brings about the problem that external host cannot initiatively communicate with the specified device in the local network.

With forwarding feature the router can penetrate the isolation of NAT and allows the external hosts in the Internet to initiatively communicate with the devices in the local network, thus to realize some special functions.

TP-LINK router includes four forwarding rules. If two or more rules are set, the priority of implementation from high to low is Virtual Servers, Port Triggering, UPnP and DMZ.

This chapter contains the following sections:

- *Share Local Resources in the Internet by Virtual Server*
- *Open Ports Dynamically by Port Triggering*
- *Make Applications Free from Port Restriction by DMZ*
- *Make Xbox Online Games Run Smoothly by UPnP*

10. 1. Share Local Resources in the Internet by Virtual Server

When you build up a server in the local network and want to share it on the Internet, Virtual Server can realize the service and provide it to the Internet users. At the same time virtual server can keep the local network safe as other services are still invisible from the Internet.

Virtual server can be used for setting up public services in your local network, such as HTTP, FTP, DNS, POP3/SMTP and Telnet. Different service uses different service port. Port 80 is used in HTTP service, port 21 in FTP service, port 25 in SMTP service and port 110 in POP3 service. Please verify the service port number before the configuration.

I want to: Share my personal website I've built in local network with my friends through the Internet.

For example, the personal website has been built in my home PC (192.168.1.100). I hope that my friends in the Internet can visit my website in some way. The PC is connected to the router with the WAN IP address 218.18.232.154.

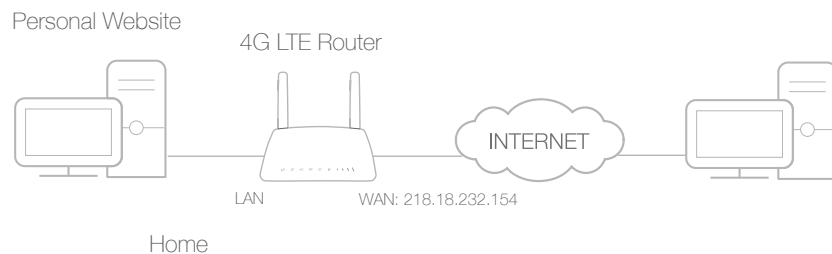

How can I do that?

1. Assign a static IP address to your PC, for example 192.168.1.100.
2. Visit <http://tplinkmodem.net>, and log in with the password you set for the router.
3. Go to [Advanced](#) > [NAT Forwarding](#) > [Virtual Servers](#), click [Add](#).

4. Click [View Existing Services](#), and choose [HTTP](#). The external port, internal port and protocol will be auto-populated. Enter the PC's IP address 192.168.1.100 in the [Internal IP](#) field.
5. Click [OK](#) to save the settings.

◆ **Tips:**

1. It is recommended to keep the default settings of [Internal Port](#) and [Protocol](#) if you are not clear about which port and protocol to use.
2. If the service you want to use is not in the [Service Type](#), you can enter the corresponding parameters manually. You should verify the port number that the service needs.
3. You can add multiple virtual server rules if you want to provide several services in a router. Please note that the [External Port](#) cannot be overlapped.

Done!

Users in the Internet can enter [http:// WAN IP](#) (in this example: [http:// 218.18.232.154](#)) to visit your personal website.

◆ **Tips:**

1. WAN IP should be a public IP address. For the WAN IP is assigned dynamically by ISP, it is recommended to apply and register a domain name for the WAN by DDNS, go to [Set Up a Dynamic DNS Service Account](#) for more information. Then you can use [http://domain name](#) to visit the website.
2. If you have changed the default [External Port](#), you should use [http://WAN IP: External Port](#) or [http://domain name: External Port](#) to visit the website.

10.2. Open Ports Dynamically by Port Triggering

Port triggering can specify a triggering port and its corresponding external ports. When a host in the local network initiates a connection to the triggering port, all the external ports will be opened for subsequent connections. The router can record the IP address of the host. When the data from the Internet return to the external ports, the

router can forward them to the corresponding host. Port triggering is mainly applied to online games, VoIPs and video players. Common applications include MSN Gaming Zone, Dialpad and QuickTime 4 players, etc.

Follow the steps below to configure the port triggering rules:

1. Visit <http://tplinkmodem.net>, and log in with the password you set for the router.
2. Go to [Advanced](#) > [NAT Forwarding](#) > [Port Triggering](#) and click [Add](#).

The screenshot shows the 'Port Triggering' configuration page. At the top, there are 'Add' and 'Delete' buttons. Below is a table with the following columns: ID, Application, Triggering Port, Triggering Protocol, External Port, External Protocol, Status, and Modify. The table is currently empty. Below the table is a form for adding a new entry. The form fields are: Interface Name (LTE), Application (MSN Gaming Zone), Triggering Port (47624), Triggering Protocol (TCP), External Port (2300-2400,28800-29000), and External Protocol (TCP). There are buttons for 'View Existing Applications', 'Enable this Entry', 'Cancel', and 'OK'.

3. Click [View Existing Applications](#), and select the desired application. The triggering port and protocol, the external port and protocol will be auto-populated. Here we take application [MSN Gaming Zone](#) as an example.
4. Click [OK](#) to save the settings.

◆ **Tips:**

1. You can add multiple port triggering rules according to your network need.
2. If the application you need is not listed in the [Existing Applications](#) list, please enter the parameters manually. You should verify the external ports the application uses first and enter them into [External Port](#) field according to the format the page displays.

10.3. Make Applications Free from Port Restriction by DMZ

When a PC is set to be a DMZ (Demilitarized Zone) host in the local network, it is totally exposed to the Internet, which can realize the unlimited bidirectional communication between internal hosts and external hosts. The DMZ host becomes a virtual server with

all ports opened. When you are not clear about which ports to open in some special applications, like IP camera and database software, you can set the PC to be a DMZ host.

Note:

DMZ is more applicable in the situation that users are not clear about which ports to open. When it is enabled, the DMZ host is totally exposed to the Internet, which may bring some potential safety hazard. If DMZ is not in use, please disable it in time.

I want to: Make the home PC join the Internet online game without port restriction.

For example, due to some port restriction, when playing the online games, you can log in normally but cannot join a team with other players. To solve this problem, set your PC as a DMZ with all ports opened.

How can I do that?

1. Assign a static IP address to your PC, for example 192.168.1.100.
2. Visit <http://tplinkmodem.net>, and log in with the password you set for the router.
3. Go to **Advanced > NAT Forwarding > DMZ** and select the checkbox to enable DMZ.

4. Enter the IP address 192.168.1.100 in the **DMZ Host IP Address** field.
5. Click **Save** to save the settings.

Done!

The configuration is completed. You've set your PC to a DMZ host and now you can make a team to game with other players.

10.4. Make Xbox Online Games Run Smoothly by UPnP

UPnP (Universal Plug and Play) protocol allows the applications or host devices to automatically find the front-end NAT device and send request to it to open the corresponding ports. With UPnP enabled, the applications or host devices in the both sides of NAT device can freely communicate with each other, realizing the seamless connection of the network. You may need to enable the UPnP if you want

to use applications for multiplayer gaming, peer-to-peer connections, real-time communication (such as VoIP or telephone conference) or remote assistance, etc.

◆ **Tips:**

1. UPnP is enabled by default in this router.
2. Only the application supporting UPnP protocol can use this feature.
3. UPnP feature needs the support of operating system (e.g. Windows Vista/ Windows 7/ Windows 8, etc. Some of operating system need to install the UPnP components).

For example, when you connect your Xbox to the router which has connected to the Internet to play online games, UPnP will send requests to the router to open the corresponding ports, allowing the following data penetrating the NAT to transmit. Therefore, you can play Xbox online games without a hitch.

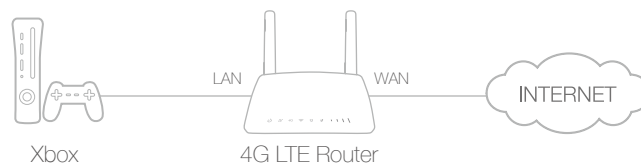

If necessary, you can follow the steps to change the status of UPnP.

1. Visit <http://tplinkmodem.net>, and log in with the password you set for the router;
2. Go to **Advanced > NAT Forwarding > UPnP** and toggle on or off according to your needs.



Chapter 11

Specify Your Network Settings

This chapter introduces how to change the default settings or adjust the basic configuration of the router using the web-based management page.

This chapter contains the following sections:

- *PIN Management*
- *Data Settings*
- *LAN Settings*
- *Wireless Settings*
- *Set Up a Dynamic DNS Service Account*
- *Create Static Routes*
- *Set up a VPN Connection*

11.1. PIN Management

PIN (Personal Identification Number) is used to protect the SIM card from embezzlement. PIN Management allows you to easily change the PIN settings of your SIM card appropriate to your needs.

Follow the steps below to change your PIN settings.

1. Visit <http://tplinkmodem.net>, and log in with the password you set for the router.
2. Go to [Advanced](#) > [Network](#) > [PIN Management](#) page.

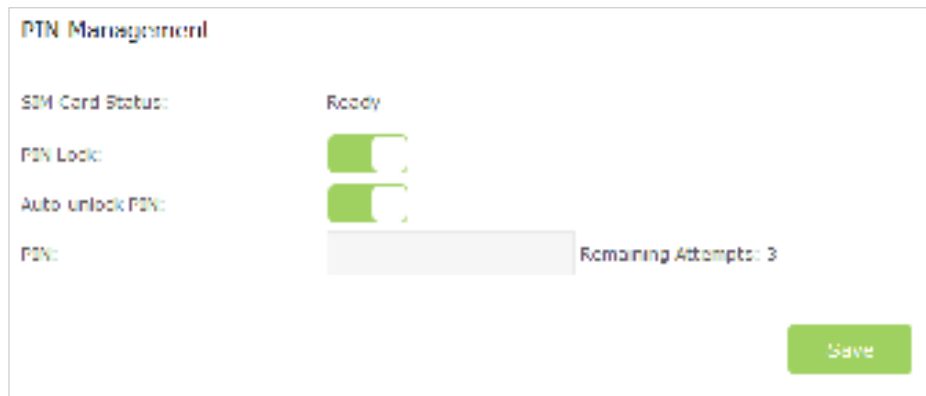

The screenshot shows the 'PIN Management' configuration page. It includes the following elements:

- SIM Card Status:** Ready
- PIN Lock:** A green toggle switch is turned on.
- Auto-unlock PIN:** A green toggle switch is turned on.
- PIN:** A text input field with a grey background.
- Remaining Attempts:** 3
- Save:** A green button at the bottom right.

- **SIM Card Status:** Displays the status of your SIM card.
 - **PIN Lock:** Toggle On to enable PIN Lock. Once it is enabled, every time you start the router with this SIM card inserted, you need to enter the PIN.
 - **Auto-unlock PIN:** When the PIN is required upon router restarting or inserting a SIM card, it will be validated automatically, saving you the trouble to enter the PIN each time you start the router or insert a SIM card. If validation failed, you need to enter the PIN on this page.
 - **PIN:** Enter the PIN to unlock the SIM card. It consists of 4-8 digits.
 - **PUK:** PIN Unlocked Key, also known as Personal Unlock Code (PUC), is used to reset a PIN that has been lost or forgotten. The PUK is a SIM-specific code assigned by the service provider. You need to enter the PUK after 3 incorrect login attempts of PIN. Contact your service provider if you do not know the PUK. It consists of 8 digits.
 - **New PIN:** Enter 4-8 digits to reset the PIN of your SIM card.
 - **Remaining Attempts:** Shows how many attempts are left for you to try entering the PIN or PUK. You have only 3 attempts for entering the PIN and 10 attempts for entering the PUK. If you accidentally fail in 3 attempts, the SIM card will be locked and you will be required to enter the PUK that is written on your SIM card.
3. Click [Save](#) to save the settings.

11.2. Data Settings

Data Settings is used to monitor the data usage of your router in real-time. You can limit your data usage according to your monthly allowance or total allowance and you will receive a warning if your data usage reaches the specified level.

Follow the steps below to monitor your data usage.

1. Visit <http://tplinkmodem.net>, and log in with the password you set for the router.
2. Go to [Advanced](#) > [Network](#) > [Data Settings](#) page.

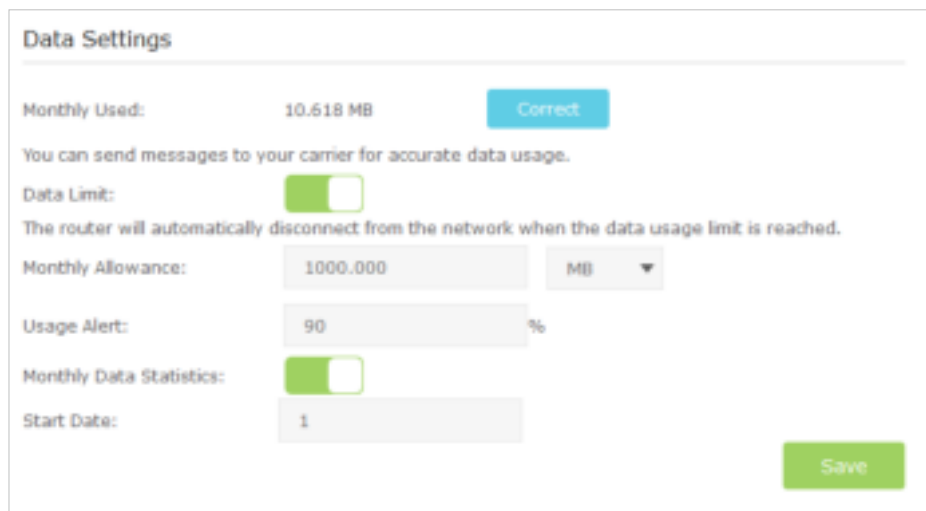

The screenshot shows the 'Data Settings' page. At the top, it displays 'Monthly Used: 10.618 MB' with a 'Correct' button. Below this, there is a note: 'You can send messages to your carrier for accurate data usage.' The 'Data Limit' section has a green toggle switch that is currently turned on, with the text 'The router will automatically disconnect from the network when the data usage limit is reached.' The 'Monthly Allowance' field is set to '1000.000' with a unit dropdown menu set to 'MB'. The 'Usage Alert' field is set to '90 %'. The 'Monthly Data Statistics' section has a green toggle switch that is currently turned on. The 'Start Date' field is set to '1'. A green 'Save' button is located at the bottom right of the form.

3. Enable [Data Limit](#) to set total/monthly data allowance and usage alert to prevent data overuse.
4. Enter the allowed amount of total/monthly data in the [Total/Monthly Allowance](#) field. When data usage exceeds the allowed level, the router will disconnect from the Internet and notify you on the [Basic > Network Map](#) Page.
5. Enter a percentage in the [Usage Alert](#) field to prevent data overuse. When data usage reaches the alert level, a warning will be shown on the [Basic > Network Map](#) Page.
6. Enable [Data Statistics](#) to reset data statistics when the next billing cycle starts.
7. Enter the start date of the billing cycle in the [Start Date](#) field.
8. Click [Save](#) to save the settings.

11.3. LAN Settings

11.3.1. Change the LAN IP Address

The router is preset with a default LAN IP 192.168.1.1, which you can use to log in to its web-based management page. The LAN IP address together with the Subnet Mask also defines the subnet that the connected devices are on. If the IP address conflicts with another device on your local network or your network requires a specific IP subnet, you can change it.

Follow the steps below to change your IP address.

1. Visit <http://tplinkmodem.net>, and log in with the password you set for the router.
2. Go to [Advanced](#) > [Network](#) > [LAN Settings](#) page.

DHCP Server	
MAC Address:	10:10:0F:00:00:57
IP Address:	192.168.1.222
Subnet Mask:	255.255.255.0
Second IP:	<input type="checkbox"/> Enable

3. Type in a new [IP Address](#) appropriate to your needs.
4. Select the [Subnet Mask](#) from the drop-down list. The subnet mask together with the IP address identifies the local IP subnet.
5. You can configure the router's [Second IP](#) and [Subnet Mask](#) for LAN interface through which you can also access the web management page.
6. Leave the rest of the default settings as they are.
7. Click [Save](#) to make the settings effective.

11.3.2. Use the 4G LTE Router as a DHCP Server

You can configure the router to act as a DHCP server to assign IP addresses to its clients. To use the DHCP server function of the router, you must configure all computers on the LAN to obtain an IP Address automatically.

Follow the steps below to configure DHCP server.

1. Visit <http://tplinkmodem.net>, and log in with the password you set for the router.
2. Go to [Advanced](#) > [Network](#) > [LAN Settings](#) page.

DHCP: Enable
 DHCP Server DHCP Relay
 IP Address Pool: 192.168.1.100 - 192.168.1.199
 Address Lease Time: 1440 minutes. (1-2880. The default value is 1440.)
 Default Gateway: 192.168.1.1 (optional)
 Default Domain: (optional)
 Primary DNS: 0.0.0.0 (optional)
 Secondary DNS: 0.0.0.0 (optional)

Save

3. Select **DHCP** to enable the DHCP function and select **DHCP Server**.
4. Specify the **IP Address Pool**, the start address and end address must be on the same subnet with LAN IP. The router will assign addresses within this specified range to its clients. It is from 192.168.1.100 to 192.168.1.199 by default.
5. Enter a value for the **Address Lease Time**. The **Address Lease Time** is the amount of time in which a DHCP client can lease its current dynamic IP address assigned by the router. After the dynamic IP address expires, the user will be automatically assigned a new dynamic IP address. The default is 1440 minutes.
6. Keep the rest of the settings as default and click **Save** to make the settings effective.

■ **Note:**

1. The router can be configured to work as a **DHCP Relay**. A DHCP relay is a computer that forwards DHCP data between computers that request IP addresses and the DHCP server that assigns the addresses. Each of the device's interfaces can be configured as a DHCP relay. If it is enabled, the DHCP requests from local PCs will be forwarded to the DHCP server that runs on WAN side.
2. You can also appoint IP addresses within a specified range to devices of the same type by using **Condition Pool** feature. For example, you can assign IP addresses within the range (192.168.1.50 to 192.168.1.80) to Camera devices, thus facilitating the network management. Enable DHCP feature and configure the parameters according to your actual situation on [Advanced > Network > LAN Settings](#) page.

11.3.3. Reserve LAN IP Addresses

You can view and add a reserved address for a client. When you specify an IP address for a device on the LAN, that device will always receive the same IP address each time when it accesses the DHCP server. If there are some devices in the LAN that require permanent IP addresses, please configure Address Reservation on the router for the purpose.

Follow the steps below to reserve an IP address for your device.

1. Visit <http://tplinkmodem.net>, and log in with the password you set for the router.
2. Go to [Advanced > Network > LAN Settings](#) page.

3. Scroll down to locate the [Address Reservation](#) table and click [Add](#) to add an address reservation entry for your device.

	MAC Address	Reserved IP	Group	Enable	Modify
<input type="checkbox"/>					

MAC Address:

Reserved IP:

Group:

Enable this entry

4. Enter the [MAC address](#) of the device for which you want to reserve IP address.
5. Specify the IP address which will be reserved by the router.
6. Check to [Enable this entry](#) and click [OK](#) to make the settings effective.

11.4. Wireless Settings

11.4.1. Specify Basic Wireless Settings

The router's wireless network name (SSID) and password, and security option are preset in the factory. The preset SSID and password can be found on the product label. You can customize the wireless settings according to your needs.

Visit <http://tplinkmodem.net>, and log in with the password you set for the router. Go to [Basic > Wireless](#) page.

The screenshot shows the 'Wireless Settings' page. It has two main sections: 'Wireless Network 2.4GHz' and 'Wireless Network 5GHz'. Each section has a checkbox for 'Enable', a text input for 'Wireless Network Name (SSID)', a checkbox for 'Hide SSID', and a text input for 'Password'. The 2.4GHz section has 'Enable' checked, SSID 'TP-LINK_510C', and password '62292863'. The 5GHz section has 'Enable' checked, SSID 'TP-LINK_510C_5G', and password '62292863'. A green 'Save' button is at the bottom right.

➤ **To enable or disable the wireless function:**

Enable the [Wireless Network 2.4GHz](#) or [5GHz](#). If you don't want to use the wireless function, just uncheck the box. If you disable the wireless function, all the wireless settings won't be effective.

➤ **To change the wireless network name (SSID) and wireless password:**

Enter a new SSID using up to 32 characters. The default SSID is TP-LINK_XXXX and the value is case-sensitive.

■ **Note:**

If you use a wireless device to change the wireless settings, you will be disconnected when the settings are effective. Please write down the new SSID and password for future use.

➤ **To hide SSID:**

Select Hide SSID, and your SSID will not broadcast. Your SSID won't display when you scan for local wireless network list on your wireless device and you need to manually join the network.

➤ **To change the mode or channel:**

Go to [Advanced](#) > [Wireless](#) > [Wireless Settings](#) page and select the wireless network 2.4GHz or 5GHz.

Mode: Select the desired mode.

- 802.11n only: Select only if all of your wireless clients are 802.11n devices.
- 802.11gn mixed: Select if you are using both 802.11g and 802.11n wireless clients.
- 802.11bgn mixed: Select if you are using a mix of 802.11b, 11g, and 11n wireless clients.

■ **Note:**

When 802.11n only mode is selected, only 802.11n wireless stations can connect to the router. It is strongly recommended that you select 802.11bgn mixed, and all of 802.11b, 802.11g, and 802.11n wireless clients can connect to the router.

- 802.11ac/n mixed (5GHz): Select if you are using both 802.11ac and 802.11n wireless clients.
- 802.11a/n/ac mixed (5GHz): Select if you are using a mix of 802.11a, 802.11n and 802.11ac wireless clients. It is strongly recommended that you select 11a/n/ac mixed.

Channel: Select the channel you want to use from the drop-down list. This field determines which operating frequency will be used. It is not necessary to change the wireless channel unless you notice interference problems with another nearby access point.

Channel Width: Select the channel width from the drop-down list. The default setting is **Automatic**, which can adjust the channel width for your clients automatically.

➤ **To change the security option:**

1. Go to **Advanced > Wireless > Wireless Settings** page.
2. Select the wireless network **2.4GHz** or **5GHz**.
3. Select an option from the **Security** drop-down list. The router provides four options, None, WPA/WPA2 Personal (Recommended), WPA/WPA2 Enterprise, WEP. WPA2 uses the newest standard and the security level is the highest. We recommend you don't change the default settings unless necessary.

11.4.2. Use WPS for Wireless Connection

You can use WPS feature to add a new wireless device to your existing network quickly.

Method 1 Use the Wi-Fi Protected Setup Button

Use this method if your client device has a Wi-Fi Protected Setup button.

1. Press the WPS/RESET button on the back panel of the router for 1 second.



2. Press the WPS button of the client device directly.
3. The WPS LED flashes for about two minutes during the WPS process.
4. When the WPS LED is on, the client device has successfully connected to the router.

Method 2 Enter the client device's PIN on the router

1. Visit <http://tplinkmodem.net>, and log in with the password you set for the router.

- Go to [Advanced](#) > [Wireless](#) > [WPS](#) page. Select the wireless network 2.4GHz or 5GHz according to your wireless client.

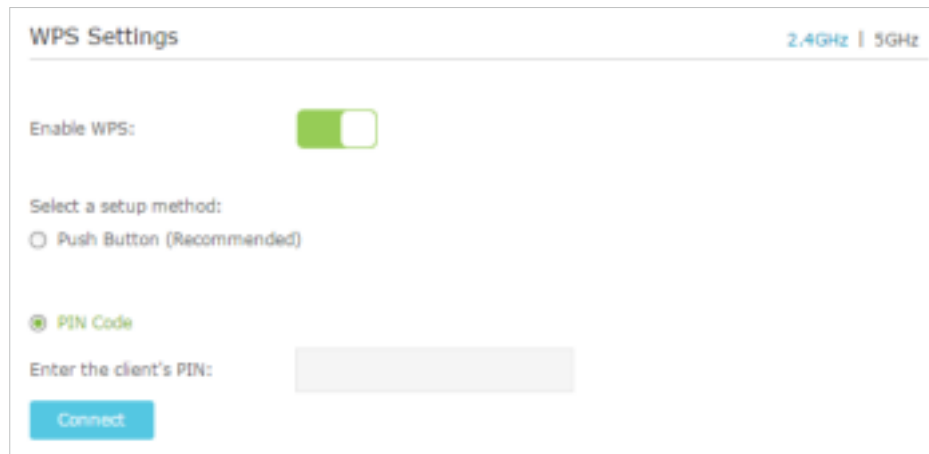

- Keep the default WPS status as Enabled and select the [PIN Code](#) radio button.
- Enter the client device's PIN in the field on the above WPS screen. Then click the [Connect](#) button.
- [Connect successfully](#) will appear on the above screen, which means the client device has successfully connected to the router.

Method 3 Enter the router's PIN on your client device

Use this method if your client device asks for the router's PIN.

- Visit <http://tplinkmodem.net>, and log in with the password you set for the router.
- Go to [Advanced](#) > [Wireless](#) > [WPS](#) page. Select the wireless network 2.4GHz or 5GHz according to your wireless client.



- Keep the Router's PIN status as enabled. Take a note of the Current PIN of the router. You can also click the [Generate](#) button to get a new PIN.
- On the client device, enter the router's PIN. (The default PIN is also labeled on the bottom of the router.)
- The WPS LED flashes for about two minutes during the WPS process.
- When the WPS LED is on, the client device has successfully connected to the router.

Note:

1. The WPS LED on the router will light on for no more than five minutes if the device has been successfully added to the network.
2. The WPS function cannot be configured if the wireless function of the router is disabled. Please make sure the wireless function is enabled before configuring the WPS.

11.4.3. Schedule Your Wireless Function

You can automatically turn off your wireless network (both 2.4GHz and 5GHz) at time when you do not need the wireless connection.

1. Visit <http://tplinkmodem.net>, and log in with the password you set for the router.
2. Go to **Advanced** > **Wireless** > **Wireless Schedule** page.
3. Select the 2.4GHz wireless network to configure. Toggle on the button to enable the Wireless Schedule feature.

Task Schedule 2.4GHz | 5GHz

Drag the mouse over the schedule table to select the period during which you need your wireless off automatically.
The Wireless Time Schedule is based on the time of the router. The time can be set in "System Tools > Time Settings" page.

Enable Wireless Schedule:

	Sun	Mon	Tue	Wed	Thu	Fri	Sat
0:00							
1:00							
2:00							
3:00							
4:00							
5:00							
6:00							
7:00							
8:00							
9:00							
10:00							
11:00							
12:00							
13:00							
14:00							
15:00							
16:00							
17:00							
18:00							
19:00							
20:00							
21:00							
22:00							
23:00							
24:00							

System Time

Restore
Save

4. Set the time. Drag the mouse to cover the time area and click **Save** to make the settings effective. The selected time will be in green
5. Repeat steps 3 and 4 to set time for 5GHz wireless network.

■ **Note:**

1. Please make sure that the time of the router is correct before using this function. For more details, refer to [Set System Time](#).
2. If you just set time for one wireless band, the other wireless band is still always on, so set time for both of the two bands to schedule your whole wireless network.
3. The wireless LED will turn off if both wireless networks are disabled.
4. The wireless network will be automatically turned on after the time period you set.

11.4.4. View Wireless Information

➤ **To view the detailed wireless network settings:**

1. Visit <http://tplinkmodem.net>, and log in with the password you set for the router.
2. Go to **Advanced** > **Status** page. You can see the **Wireless** box.
3. Select 2.4GHz or 5GHz to view the wireless details.

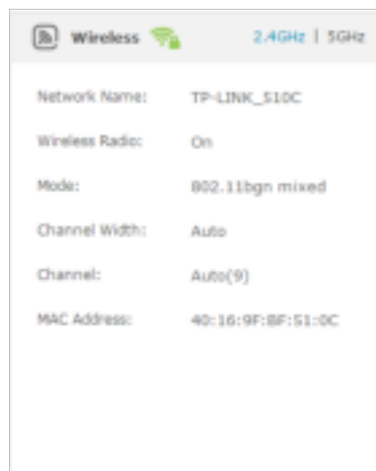

◆ **Tips:** You can also see the wireless details by clicking the router icon on **Basic** > **Network Map**.

➤ **To view the detailed information of the connected wireless clients:**

1. Visit <http://tplinkmodem.net>, and log in with the password you set for the router.
2. Go to **Advanced** > **Wireless** > **Statistics** page.
3. You can view the detailed information of the wireless clients, including its connected wireless band and security option as well as the packets transmitted.

◆ **Tips:** You can also see the wireless details by clicking the wireless clients icon on **Basic** > **Network Map**.

11.4.5. Advanced Wireless Settings

Advanced wireless settings are for those who have a network concept. If you are not familiar with the settings on this page, it's strongly recommended that you keep the provided default values; otherwise it may result in lower wireless network performance.

1. Visit <http://tplinkmodem.net>, and log in with the password you set for the router.
2. Go to [Advanced](#) > [Wireless](#) > [Advanced Settings](#) page.

Setting	Value	Range
Beacon Interval:	100	(25-1000)
RTS Threshold:	2346	(1-2346)
DTIM Interval:	1	(1-255)
Group Key Update Period:	0	seconds
WMM:	<input checked="" type="checkbox"/> Enable	
Short GI:	<input checked="" type="checkbox"/> Enable	
AP Isolation:	<input type="checkbox"/> Enable	

- **Beacon Interval:** Enter a value between 25 and 1000 in milliseconds to determine the duration between which beacon packets are broadcasted by the router to synchronize the wireless network. The default is 100 milliseconds.
- **RTS Threshold:** Enter a value between 1 and 2346 to determine the packet size of data transmission through the router. By default, the RTS (Request to Send) Threshold size is 2346. If the packet size is greater than the preset threshold, the router sends Request to Send frames to a particular receiving station and negotiates the sending of a data frame, or else the packet will be sent immediately.
- **DTIM Interval:** Enter a value between 1 and 255 to determine the interval of the Delivery Traffic Indication Message (DTIM). 1 indicates the DTIM Interval is the same as **Beacon Interval**.
- **Group Key Update Period:** Enter the number of seconds (minimum 30) to control the time interval for the encryption key automatic renewal. The default is 0, indicating no key renewal.
- **Enable WMM:** This feature guarantees the packets with high-priority messages being transmitted preferentially. WMM is enabled compulsively under 802.11n or 802.11ac mode. It is strongly recommended to enable WMM.
- **Enable Short GI:** This feature is enabled by default and recommended to increase the data capacity by reducing the Guard Interval (GI) time.

- **AP Isolation:** Select this checkbox to enable the AP Isolation feature that allows you to confine and restrict all wireless devices on your network from interacting with each other, but still able to access the Internet. AP isolation is disabled by default.
- **WDS:** Select this checkbox to enable the WDS (Wireless Distribution System) Bridging feature to allow the router to bridge with another access point (AP) in a wireless local area network (WLAN). Refer to [Appendix B: Troubleshooting](#) for detailed instructions.

11.5. Set Up a Dynamic DNS Service Account

Most ISPs (Internet service providers) assign a dynamic IP address to the router and you can use this IP address to access your router remotely. However, the IP address can change any time and you don't know when it changes. In this case, you might need the DDNS (Dynamic Domain Name Server) feature on the router to allow you and your friends to access your router and local servers (FTP, HTTP, etc.) using domain name, in no need of checking and remembering the IP address.

■ **Note:** DDNS does not work if the ISP assigns a private WAN IP address (such as 192.168.1.x) to the router.

To set up DDNS, please follow the instructions below:

1. Visit <http://tplinkmodem.net>, and log in with the password you set for the router.
2. Go to [Advanced](#) > [Network](#) > [Dynamic DNS](#).
3. Select the [DDNS service provider](#) (Dyndns or NO-IP). If you don't have a DDNS account, select a service provider and click [Go to register](#).

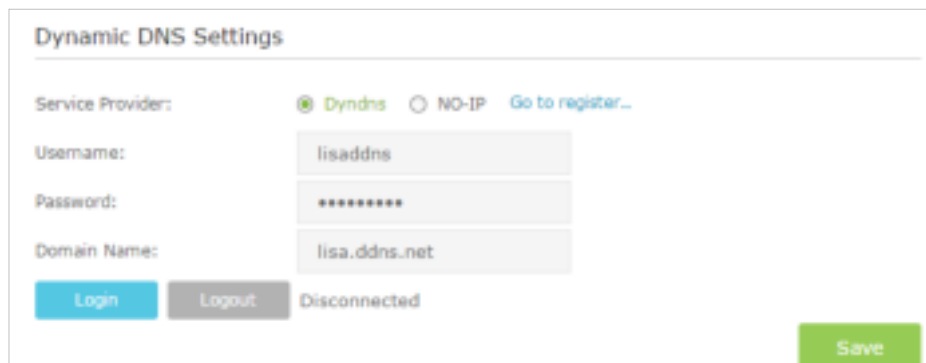

Dynamic DNS Settings

Service Provider: Dyndns NO-IP [Go to register...](#)

Username:

Password:

Domain Name:

Disconnected

4. Enter the username, password and domain name of the account (such as lisa.ddns.net).
5. Click [Login](#) and [Save](#).

💡 **Tips:** If you want to use a new DDNS account, please log out first, then log in with the new account.

11.6. Create Static Routes

A static route is a pre-determined path that network information must travel to reach a specific host or network. Data from one point to another will always follow the same path regardless of other considerations. Normal Internet usage does not require this setting to be configured.

I want to:

Visit multiple networks and multiple servers at the same time.

For example, in a small office, my PC can surf the Internet, but I also want to visit my company's server. Now I have a switch and another router. I connect the devices as shown in the following figure so that the physical connection between my PC and my company's server is achieved. To surf the Internet and visit my company's network at the same time, I need to configure the static routing.

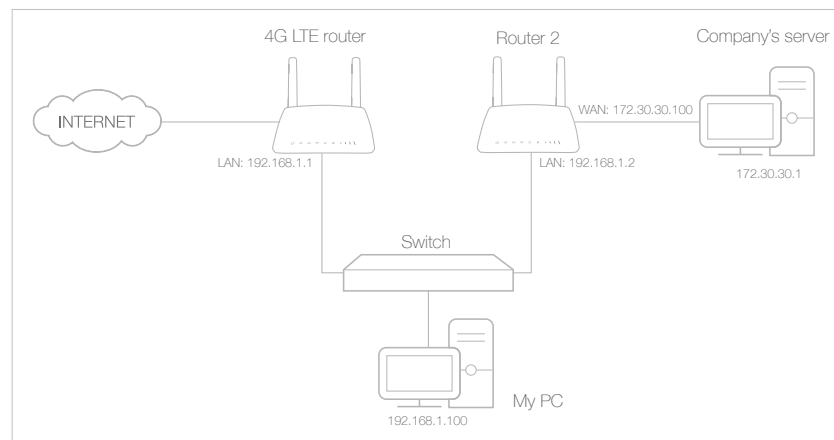

How can I do that?

1. Make sure the routers use different LAN IP addresses on the same subnet. Disable Router 2's DHCP function.
2. Visit <http://tplinkmodem.net>, and log in with the password you set for the router.
3. Go to **Advanced > Network > Advanced Routing**. Select your current **WAN Interface** and click **Save**.

Default Gateway Settings IPv4 | IPv6

Select a WAN interface as the system default gateway.

Select WAN Interface: LTE

Save

Static Routing + Add - Delete

<input type="checkbox"/>	ID	Destination IP	Subnet Mask	Gateway	Enable	Modify
—	—	—	—	—	—	—

4. Click [Add](#) to add a new static routing entry. Finish the settings according to the following explanations:

Static Routing + Add - Delete

<input type="checkbox"/>	ID	Destination IP	Subnet Mask	Gateway	Enable	Modify
—	—	—	—	—	—	—

Destination IP: 172.30.30.1

Subnet Mask: 255.255.255.255

Gateway: 192.168.1.2

Interface: LTE

Enable this entry

Cancel OK

- **Destination IP:** The destination IP address that you want to assign to a static route. This IP address cannot be on the same subnet with the WAN IP or LAN IP of the router. In the example, the IP address of the company network is the destination IP address, so here enters 172.30.30.1.
- **Subnet Mask:** Determines the destination network with the destination IP address. If the destination is a single IP address, enter 255.255.255.255; otherwise, enter the subnet mask of the corresponding network IP. In the example, the destination network is a single IP, so here enters 255.255.255.255.
- **Gateway:** The IP address of the gateway device to which the data packets will be sent. This IP address must be on the same subnet with the router's IP which sends out the data. In the example, the data packets will be sent to the LAN port of

Router 2 and then to the Server, so the gateway should be 192.168.1.2

- **Interface:** Determined by the port (LTE/LAN) that sends out the data packets. In the example, the data is sent to the gateway through the LTE port, so LTE should be selected.
5. Select the checkbox to enable this entry.
 6. Click **OK** to save the settings.

Done!

Open a web browser on your PC. Enter the company server's IP address to visit the company network.

11.7. Set up a VPN Connection

VPN (Virtual Private Network) is a private network established across the public network, generally via the Internet. However, the private network is a logical network without any physical network lines, so it is called Virtual Private Network.

With the wide application of the Internet, more and more data are needed to be shared through the Internet. Connecting the local network to the Internet directly, though can allow the data exchange, will cause the private data to be exposed to all the users on the Internet.

The VPN (Virtual Private Network) technology is developed and used to establish the private network through the public network, which can provides a secure communication to a remote computer or remote network, and guarantee a secured data exchange. IPSec is one of the major implementations of VPNs.

I want to:

Establish an IPSec VPN tunnel to connect two LANs via Internet so that the hosts in different remote LANs are able to communicate with each other as if they are in the same LAN.

For example, I am the network administrator of a regional office, I need to let my office staff to visit the headquarters' servers and resources, and vice versa. I know that the router in my office and the device in headquarters both support IPSec VPN feature, so I decide to set up a VPN connection with the headquarter office.

The following diagram is a typical VPN topology. Here Site A refers to regional office's network (local network). And Site B refers to the headquarters' network (remote network) which I want to connect to.

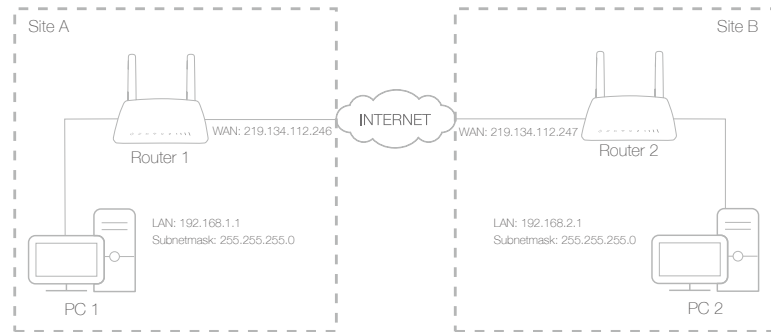

How can I do that?

1. Make sure of the topology you want to build and record site A (local network) and site B (remote network)'s LAN IP and WAN IP.
2. Configuration on site A (local network).
 - 1) Visit <http://tplinkmodem.net>, and log in with the password you set for the router.
 - 2) Go to **Advanced** > **Network** > **IPSec VPN** to open the configuration page. Click **Add** to set up a VPN tunnel.

IPsec Settings

Dead Peer Detection:

Connection Name	Remote Gateway	Local Address	Remote Address	Status	Enable	Modify
VPN1	210.134.112.247					

IPsec Connection Name: VPN1

Remote IPsec Gateway (URL): 210.134.112.247 Site B's WAN IP

Tunnel access from local IP addresses: Subnet Address

IP Address for VPN: 192.168.1.0 LAN IP range of Site A

Subnet Mask: 255.255.255.0

Tunnel access from remote IP addresses: Subnet Address

IP Address for VPN: 192.168.2.0 LAN IP range of Site B

Subnet Mask: 255.255.255.0

Key Exchange Method: Auto(IKE)

Authentication Method: Pre-Shared Key

Pre-Shared Key: 12345678

Perfect Forward Secrecy: Enable

Advanced

Cancel OK

- 3) In the **IPsec Connection Name** column, specify a name.
- 4) In the **Remote IPsec Gateway (URL)** column, Enter Site B's WAN IP address.
- 5) To configure **Site A's LAN**:

In the **Tunnel access from local IP addresses** column, here we take **Subnet Address** as an example. Then input the LAN IP range of Site A in the **IP Address for VPN** column, and input **Subnet Mask** of Site A.

- 6) To configure **Site B's LAN**:

In the **Tunnel access from local IP addresses** column, here we take **Subnet Address** as an example. Then input the LAN IP range of Site B in the **IP Address for VPN** column, and input **Subnet Mask** of Site B.

- 7) Select the **Key Exchange Method** for the policy. We select **Auto(IKE)** here.

- 8) Enter the **Pre-Shared Key** for IKE authentication. Then keep **Perfect Forward Secrecy** enabled.
 - **Note:**
Make sure Site A and Site B use the same key.
 - 9) Leave the **Advanced Settings** as default value. Then click **OK** to save.
3. Configuration on Site B (remote network). Refer to step 2 configuration on Site A and make sure that Site A and Site B use the same **pre-shared keys** and **Perfect Forward Secrecy** settings.
 4. The **Status** column will change to **Up** if the VPN connection has been set up successfully.
 5. 5. Check the VPN connection. You can ping site B' LAN IP from your computer to verify that the IPSec VPN connection is set up correctly.
 - ◆ **Tips:** To check the VPN connection, you can do the following.
 - a . On the host in Site A, press [**Windows Logo**] + [**R**] to open Run dialog. Input "**cmd**" and hit **OK**.

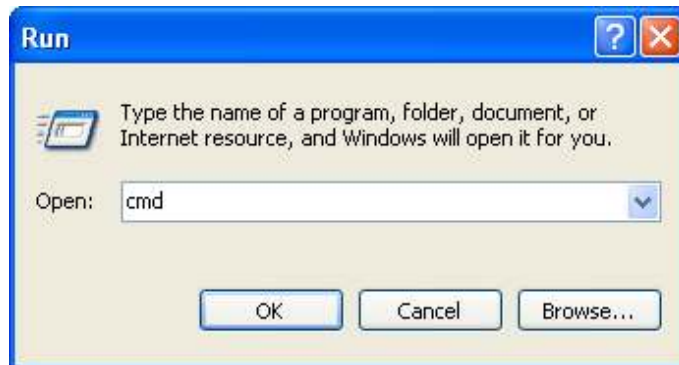

- b . In the CLI window, type in "ping 192.168.2.x" ("192.168.2.x" can be IP address of any host in Site B). Then press [Enter].

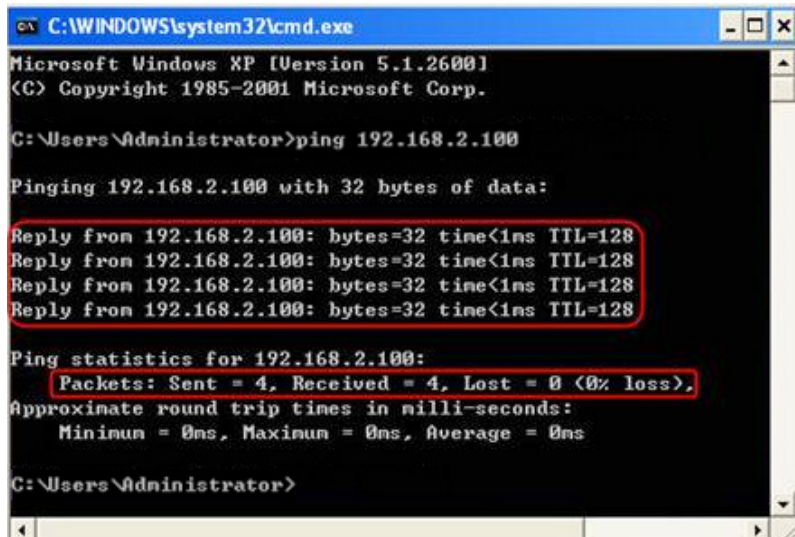

```
C:\WINDOWS\system32\cmd.exe
Microsoft Windows XP [Version 5.1.2600]
(C) Copyright 1985-2001 Microsoft Corp.

C:\Users\Administrator>ping 192.168.2.100

Pinging 192.168.2.100 with 32 bytes of data:

Reply from 192.168.2.100: bytes=32 time<1ms TTL=128
Reply from 192.168.2.100: bytes=32 time<1ms TTL=128
Reply from 192.168.2.100: bytes=32 time<1ms TTL=128
Reply from 192.168.2.100: bytes=32 time<1ms TTL=128

Ping statistics for 192.168.2.100:
    Packets: Sent = 4, Received = 4, Lost = 0 (0% loss),
    Approximate round trip times in milli-seconds:
        Minimum = 0ms, Maximum = 0ms, Average = 0ms

C:\Users\Administrator>
```

- c. If Ping proceeds successfully (gets replies from host in Site B), the IPSec connection is working properly now.

Done!

Now IPSec VPN is implemented to establish a connection.

Note:

1. The product supports a maximum of ten simultaneous connections.
2. If one of the site has been off line for a while, for example, if Site A has been disconnected, on Site B you need to click [Disable](#) and then click [Enable](#) after Site A back on line in order to re-establish the IPSec tunnel.

Chapter 12

Administrate Your Network

This chapter introduces how to change the system settings and administrate your router's network.

This chapter contains the following sections:

- *Set System Time*
- *Update the Firmware*
- *Back up and Restore Configuration Settings*
- *Change the Administrator Account*
- *Local Management*
- *Remote Management*
- *System Log*
- *Monitor the Internet Traffic Statistics*
- *CWMP Settings*
- *SNMP Settings*

12.1. Set System Time

System time is the time displayed while the router is running. The system time you configure here will be used for other time-based functions like Parental Controls and Wireless Schedule. You can manually set how to get the system time.

Follow the steps below to set your system time.

1. Visit <http://tplinkmodem.net>, and log in with the password you set for the router.
2. Go to [Advanced](#) > [System Tools](#) > [Time Settings](#) page.

The screenshot shows the 'Time Settings' page. It includes a dropdown for 'Time Zone' set to '(GMT) Greenwich Mean Time: Dublin, Edinburgh, London, Lisbon'. The 'Date' field is '1/1/1970' with a '(MM/DD/YY)' label. The 'Time' field is '1 : 2 : 39'. There are two 'NTP Server' fields, both set to '0.0.0.0' with '(optional)' labels. At the bottom, there are three buttons: 'Get from PC', 'Get GMT', and 'Save'.

3. Configure the system time using the following methods :
 - Manually:** Select your time zone and enter your local time.
 - Get from PC:** Click this button if you want to use the current managing PC's time.
 - Get GMT:** Click this button if you want to get time from the Internet. Make sure your router can access the Internet before you select this way to get system time.
4. Click [Save](#) to make your settings effective.
5. After setting the system time, you can set [Daylight Saving](#) time according to your needs. Tick the checkbox to enable [Daylight Saving](#), set the start and end time and then click [Save](#) to make the settings effective.

The screenshot shows the 'Daylight Saving' page. It features a checkbox labeled 'Enable Daylight Saving' which is checked. Below it are two rows for 'Start' and 'End' times. The 'Start' row has dropdowns for 'Mar', 'M', 'Last', 'W', 'Sun', 'T', and a time field '02:00'. The 'End' row has dropdowns for 'Oct', 'M', 'Last', 'W', 'Sun', 'T', and a time field '03:00'. A 'Save' button is located at the bottom right.

12.2. Update the Firmware

TP-LINK is dedicated to improving and enriching the product features, giving you a better network experience. We will release the latest firmware at TP-LINK official website, you can download the latest firmware file from our website: www.tp-link.com and upgrade the firmware to the latest version.

Follow the steps below to update your firmware to the latest.

1. Download the latest firmware file from our website: www.tp-link.com.
2. Visit <http://tplinkmodem.net>, and log in with the password you set for the router.
3. Go to [Advanced](#) > [System Tools](#) > [Firmware Upgrade](#) page.



4. Click [Browse](#) to locate the downloaded new firmware file, and click [Upgrade](#).
5. Wait for the upgrading and then the router will automatically reboot.

■ **Note:**

1. Before upgrading the firmware, it's better to back up your current settings. For more details, refer to [Back up and Restore Configuration Settings](#).
2. During the upgrading process, do not turn off or reset the router.
3. The upgraded firmware version must correspond to the hardware.

12.3. Back up and Restore Configuration Settings

The configuration settings are stored as a configuration file in the router. You can back up the configuration file to your computer for future use and restore the router to a previous settings from the backup file when needed. Moreover, if needed you can erase the current settings and reset the router to the default factory settings.

To back up configuration settings:

1. Visit <http://tplinkmodem.net>, and log in with the password you set for the router.
2. Click [Advanced](#) > [System Tools](#) > [Backup & Restore](#) page.
3. Click [Backup](#) to save a copy of the current settings to your local computer. A conf. bin file will be stored to your computer.

To restore configuration settings:

1. Visit <http://tplinkmodem.net>, and log in with the password you set for the router.
2. Click [Advanced](#) > [System Tools](#) > [Backup & Restore](#) page.

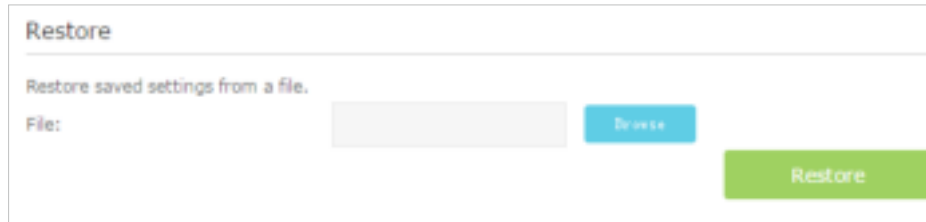

3. Click [Browse](#) to locate the previous backup configuration file, and click [Restore](#).
4. Wait for the restoring and then the router will automatically reboot.

To reset the router to factory default settings:

1. Visit <http://tplinkmodem.net>, and log in with the password you set for the router.
2. Click [Advanced](#) > [System Tools](#) > [Backup & Restore](#) page.
3. Click [Factory Restore](#) to reset the router.
4. Wait for the resetting and then the router will automatically reboot.

■ Note:

1. Do not interrupt or turn off the router during the resetting process.
2. We strongly recommend you to back up the current configuration settings before resetting the router.

12.4. Change the Administrator Account

Admin account is used to log in to the router's web-based management page. You are required to set the admin account at the first login. You can change it on the web page.

1. Visit <http://tplinkmodem.net>, and log in with the password you set for the router.
2. Go to [Advanced](#) > [System Tools](#) > [Administration](#) page. Locate the [Account Management](#) section.



3. Enter the old password. Enter the new password and enter again to confirm.
4. Click [Save](#) to make the settings effective.

12.5. Local Management

You can control the local devices' authority to manage the router via the Local Management feature. By default all local connected devices are allowed to manage the router. You can also allow only one device to manage the router.

Follow the steps below to specify the local management.

1. Visit <http://tplinkmodem.net>, and log in with the password you set for the router.
2. Go to [Advanced](#) > [System Tools](#)> [Administration](#) page. Locate the [Local Management](#) section.
3. Keep the Port as the default setting. Enter the [IP address](#) or [MAC address](#) of the local device to manage the router.



The screenshot shows a web interface for 'Local Management'. It has two input fields: 'Port' with the value '80' and 'IP/MAC Address' with the value '192.168.1.100'. A green 'Save' button is located at the bottom right of the form.

4. Click [Save](#) to make the settings effective. Now only the device (192.168.1.100) can manage the router. If you want all local devices to manage the router, just leave the [IP/MAC Address](#) field blank.

12.6. Remote Management

By default, the remote devices are not allowed to manage the router from the Internet. Follow the steps below to allow remote devices to manage the router.

1. Visit <http://tplinkmodem.net>, and log in with the password you set for the router.
2. Go to [Advanced](#) > [System Tools](#)> [Administration](#) page. Locate the [Remote Management](#) section.

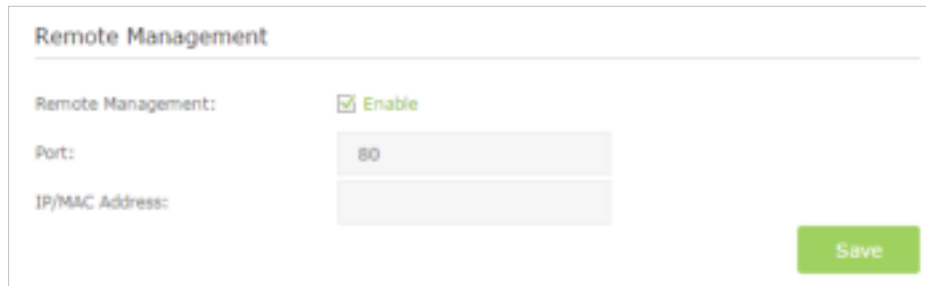

Remote Management

Remote Management: Enable

Port: 80

IP/MAC Address:

Save

3. Tick the checkbox to enable [Remote Management](#). Keep the [Port](#) as the default setting. Leave the [IP/MAC Address](#) field blank. If you just want to allow a specific device to manage the router, you can enter the IP address of the remote device in the [IP/MAC Address](#) field.
4. Click [Save](#) to make the settings effective. Now, all devices on the Internet can log in to [http://router's WAN IP address:port number](#) (such as [http://113.116.60.229:80](#)) to manage the router.

◆ Tips:

1. You can find the WAN IP address of the router on [Basic > Network Map > Internet](#).
2. The router's WAN IP is usually a dynamic IP. Please refer to [Set Up a Dynamic DNS Service Account](#) if you want to log in to the router through a domain name.

12.7. System Log

System Log can help you know what happens to your router, facilitating you to locate the malfunctions. For example when your router does not work properly, you will need to save the system log and send it to the technical support for troubleshooting.

1. Visit <http://tplinkmodem.net>, and log in with the password you set for the router.
2. Click [Advanced > System Tools > System Log](#) page.

System Log

Type:

Level:

[Refresh](#) [Delete All](#)

ID	Time	Type	Level	Log Content
1	1970-01-01 00:46:15	IGMP	Warning	V2 igmp router occurred! Not matching ours V3.
2	1970-01-01 00:45:15	IGMP	Warning	V2 igmp router occurred! Not matching ours V3.
3	1970-01-01 00:44:10	IGMP	Warning	V2 igmp router occurred! Not matching ours V3.
4	1970-01-01 00:43:10	IGMP	Warning	V2 igmp router occurred! Not matching ours V3.
5	1970-01-01 00:42:41	DHCPD	Notice	Recv REQUEST from 48:43:7C:80:B4:ED
6	1970-01-01 00:42:39	DHCPD	Notice	Send OFFER with ip 192.168.0.100
7	1970-01-01 00:42:39	DHCPD	Notice	Recv DISCOVER from 48:43:7C:80:B4:ED
8	1970-01-01 00:42:05	IGMP	Warning	V2 igmp router occurred! Not matching ours V3.

[Log Settings](#) [Save Log](#)

1 2 3 4 5 6 7 8

To view the system logs:

1. Select the log Type. Select [ALL](#) to view all kinds of logs, or select [DHCPD](#) or [IGMP](#) to view the specific logs.
2. Select the log Level and you will see the logs with the specific or higher levels.
3. Click [Refresh](#) to refresh the log list.

To save the system logs:

You can choose to save the system logs to your local computer or a remote server.

Click [Save Log](#) to save the logs in a txt file to your computer.

Click [Log Settings](#) to set the save path of the logs.

The screenshot shows the 'Log Settings' configuration page. It is divided into two main sections: 'Save Locally' and 'Save Remotely'. Both sections have their respective checkboxes checked. The 'Save Locally' section includes a 'Minimum Level' dropdown menu currently set to 'Information'. The 'Save Remotely' section includes a 'Minimum Level' dropdown menu set to 'Warning', a 'Server IP' field with the value '192.168.1.100', a 'Server Port' field with the value '514', and a 'Local Facility Name' dropdown menu set to 'User'. At the bottom right of the form, there are two green buttons labeled 'Back' and 'Save'.

- **Save Locally:** Select this option to cache the system log to the router's local memory, select the minimum level of system log to be saved from the drop-down list. The logs will be shown in the table in descending order on the System Log page.
- **Save Remotely:** Select this option to send the system log to a remote server, select the minimum level of system log to be saved from the drop-down list and enter the information of the remote server. If the remote server has a log viewer client or a sniffer tool implemented, you can view and analyze the system log remotely in real-time.

12.8. Monitor the Internet Traffic Statistics

The Traffic Statistics page displays the network traffic of the LAN, WAN and WLAN sent and received packets, allowing you to monitor the volume of Internet traffic statistics.

1. Visit <http://tplinkmodem.net>, and log in with the password you set for the router.
2. Go to [Advanced](#) > [System Tools](#) > [Statistics](#) page.
3. Toggle on [Traffic Statistics](#), and then you can monitor the traffic statistics in [Traffic Statistics List](#) section. This function is disabled by default.

Traffic Statistics

Enable Traffic Statistics:

Traffic Statistics List

IP Address/MAC Address	Total Packets	Total Bytes	Current Packets	Current Bytes	Current ICMP Tx	Current UDP Tx	Current SYN Tx	Modify
192.168.1.100 98:76:54:3210:11	0	542	0	0	0	0	0	<input type="button" value="Refresh"/> <input type="button" value="Delete"/>

12.9. CWMP Settings

The router offers CWMP feature. The function supports TR-069 protocol which collects information, diagnoses the devices and configures the devices automatically via ACS (Auto-Configuration Server).

1. Visit <http://tplinkmodem.net>, and log in with the password you set for the router.
2. Go to [Advanced](#) > [System Tools](#) > [CWMP Settings](#) page.

CWMP Settings

WAN Management Protocol (also called TR-069) allows Auto-Configuration Server (ACS) to perform auto-configuration, provision, connection, and diagnostics to this device. You may configure this function under your ISP's instructions.

Enable CWMP:

Inform:

Inform Interval(seconds):

ACS URL:

ACS Username:

ACS Password:

Interface used by TR-069 client:

Display SOAP messages on serial console:

Connection Request Authentication

Connection Request Username:

Connection Request Password:

Connection Request Path:

Connection Request Port:

Connection Request URL:

- **Enable CWMP:** Toggle On to enable the CWMP (CPE WAN Management Protocol) feature.
- **Inform:** Enable this feature to send an Inform message to the ACS (Auto Configuration Server) periodically.
- **Inform Interval:** Enter the time in seconds when the Inform message will be sent to the ACS.
- **ACS URL:** Enter the web address of the ACS which is provided by your ISP.
- **ACS Username/Password:** Enter the username/password to log in to the ACS server.
- **Interface used by TR-069 client:** Select which interface to be used by the TR-069 client.
- **Display SOAP messages on serial console:** Toggle to enable or disable this feature.
- **Connection Request Authentication:** Select this checkbox to enable authentication for the connection request.
- **Connection Request Username/Password:** Enter the username/password for the ACS server to log in to the router.
- **Connection Request Path:** Enter the path for the ACS server to log in to the router.

- **Connection Request Port:** Enter the port that connects to the ACS server.
- **Connection Request URL:** Enter the URL that connects to the ACS server.
- **Get RPC methods:** Click to get the methods to support CWMP.

Click **Save** to make the settings effective.

12. 10. SNMP Settings

SNMP (Simple Network Management Protocol) has been widely applied in the computer networks currently, which is used for ensuring the transmission of the management information between two nodes. In this way, network administrators can easily search and modify the information on any node on the network. Meanwhile, they can locate faults promptly and implement the fault diagnosis, capacity planning and report generating.

An **SNMP Agent** is an application running on the router that performs the operational role of receiving and processing SNMP messages, sending responses to the SNMP manager, and sending traps when an event occurs. So a router contains SNMP “agent” software can be monitored and/or controlled by SNMP Manager using SNMP messages.

1. Visit <http://tplinkmodem.net>, and log in with the password you set for the router.
2. Go to **Advanced > System Tools > SNMP Settings** page.

SNMP Settings

Simple Network Management Protocol (SNMP) allows management applications to retrieve status updates and statistics from the SNMP agent within this device.

Enable SNMP Agent:

Read Community: public

Set Community: private

System Name: MR200

System Description: 0.0.1 0.0 v001a.0

System Location:

System Contact:

Trap Manager IP: 0.0.0.0

Save

- **Enable SNMP Agent:** Toggle On to enable the built-in SNMP agent that allows the router to operate as the operational role in receiving and processing of SNMP messages, sending responses to the SNMP manager, and triggering SNMP traps when an event occurs.

- **Read Community:** Displays the default public community string that protects the router from unauthorized access.
- **Set Community:** Displays the default read and write community string that protects the router from unauthorized changes.
- **System Name:** Displays the administratively-assigned name for this managed device.
- **System Description:** Displays the textual description of the managed device. This value should include the full name and version identification of the system's hardware type, software operating-system, and networking software.
- **System Location:** Displays the physical location of this device (e.g. telephone closet, 3rd floor).
- **System Contact:** Displays the textual identification of the contact person for this managed device, together with information on how to contact this person.
- **Trap Manager IP:** Displays the IP address of the host to receive the traps.

You are suggested to keep the default settings. Click [Save](#) to make the settings effective.

Appendix A: Specifications

HARDWARE FEATURES

Interface	1 10/100Mbps RJ45 WAN/LAN Port 3 10/100Mbps RJ45 LAN Ports 1 SIM Card Slot
Button	1 Power On/Off Button 1 Wi-Fi On/Off Button 1 WPS/RESET Button
Antenna Type	WiFi Antenna :3 internal antennas LTE Antenna: 2 detachable external antennas

Mobile Network FEATURES

Network Type	LTE/DC- HSPA+/HSPA+/HSPA/UMTS/EDGE/GRPS/GSM
Band	FDD-LTE: 800MHz(Band20), 900MHz(Band8), 1800MHz(Band3), 2100MHz(Band1), 2600MHz(Band7) TDD-LTE: 2300MHz(Band40): 2600MHz(Band38) DC-HSPA+/HSPA+/HSPA/UMTS: 900MHz, 2100MHz EDGE/GPRS/GSM: 850/900/1800/1900MHz
Data Rates	Cat 4 FDD DL: 150Mbps, UL: 50Mbps TDD DL: 112Mbps, UL: 32Mbps

WIRELESS FEATURES

Wireless Standards	IEEE 802.11ac/n/a 5GHz IEEE 802.11n/g/b2.4GHz
Wireless Speeds	5GHz: Up to 433Mbps 2.4GHz: Up to 300Mbps
Frequency	2.4GHz: 2412-2472MHz; 5GHz: 5150-5250MHz, 5250-5350MHz, 5470-5725MHz
EIRP	<20dBm(EIRP)
Wireless Functions	Wireless Radio, WDS Bridge, WMM, Wireless Statistics
Wireless Security	64/128-bit WEP,WPA / WPA2,WPA-PSK/ WPA2-PSK encryption, Wireless MAC Filtering
Wireless Schedule	Support 2.4GHz and 5GHz Wireless Schedule

SOFTWARE FEATURES

Operation Mode	3G/4G Router, Wireless Router
DHCP	Server, Client, DHCP Client List, Address Reservation, DHCP relay
Quality of Service	Traffic Control(IP QoS)
Port Forwarding	Virtual server, Port Triggering, DMZ, ALG, UPnP
VPN Pass-through	PPTP, L2TP, IPSec Pass-through
Dynamic DNS	DynDns, NO-IP
IPSec VPN	Supports up to 10 IPSec VPN tunnels
Guest Network	2.4GHz guest network × 1 5GHz guest network × 1
Security	Access Control, MAC Filtering, IP and MAC Address Binding
Management	Web Based Configuration (HTTP), Remote management, Command Line Interface, SSL for TR-069, SNMP v1/2, Web Based Firmware Upgrade, Diagnostic Tools
IPv6	IPv6 and IPv4 dual stack
Advanced Features	Parental Controls Network Address Translation (NAT); Port Mapping (Grouping), Static Routing, RIP v1/v2; DNS Relay, DDNS, IGMP V1/V2/V3,

Physical and Environment

Operating Temperature	0 °C ~ 40 °C
Working Humidity	10% ~ 90% RH (non-condensing)
Storage Temperature	-40 °C ~ 70 °C
Storage Humidity	5% ~ 90% RH (non-condensing)

*Only 2.412GHz~2.462GHz is allowed to be used in USA, which means only channel 1~11 is available for American users to choose.

Appendix B:

Troubleshooting

T1. How do I restore my router's configuration to its factory default settings?

With the router powered on, press and hold the WPS/RESET button on the rear panel until the Power LED starts flashing.

■ **Note:** Once the router is reset, the current configuration settings will be lost and you will need to re-configure the router.

T2. What can I do if I forget my password?

Web Management page password:

Restore the router to its factory default settings and then create a new password using 1-15 characters.

Wireless Network password:

1. The default Wireless Password/PIN is printed on the product label of the router.
2. If the default wireless password has been changed, log into the router's web management page and go to [Basic](#) > [Wireless](#) to retrieve or reset your password.

T3. What can I do if I cannot log into the router's web management page?

- Make sure the router connects to the computer correctly and the corresponding LED indicator(s) light up.
- Make sure the IP address of your computer is configured as "Obtain an IP address automatically" and "Obtain DNS server address automatically".
- Make sure the default access you input is right.
- Check your computer's settings:
 - 1) Go to [Start](#) > [Control Panel](#) > [Network and Internet](#), and click [View network status and tasks](#);
 - 2) Click [Internet Options](#) on the bottom left;
 - 3) Click [Connections](#), select [Never dial a connection](#);

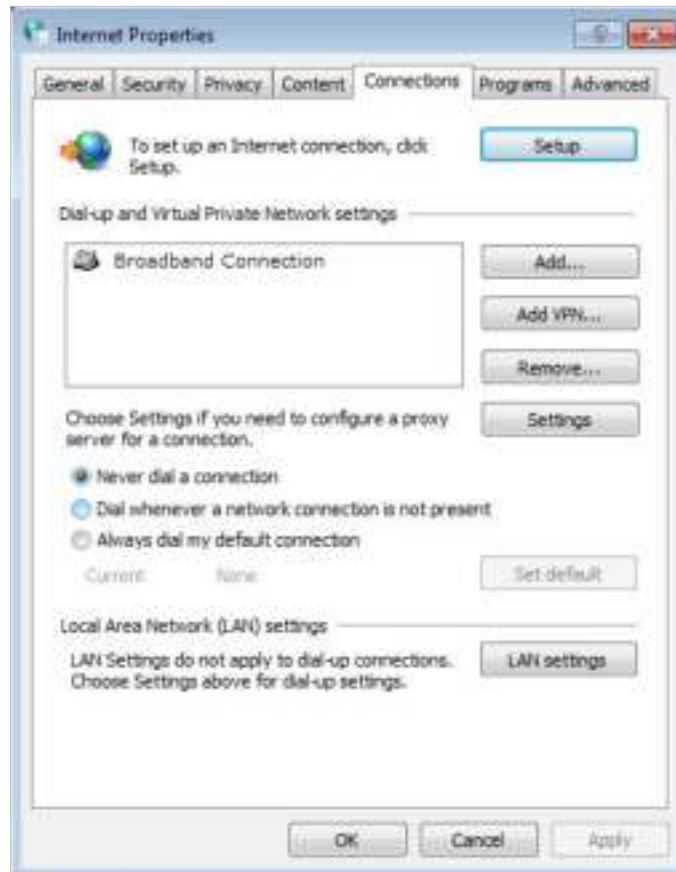

4) Click [LAN settings](#), deselect the following three options and click [OK](#);



5) Go to [Advanced](#) > [Restore advanced settings](#), click [OK](#) to save the settings.

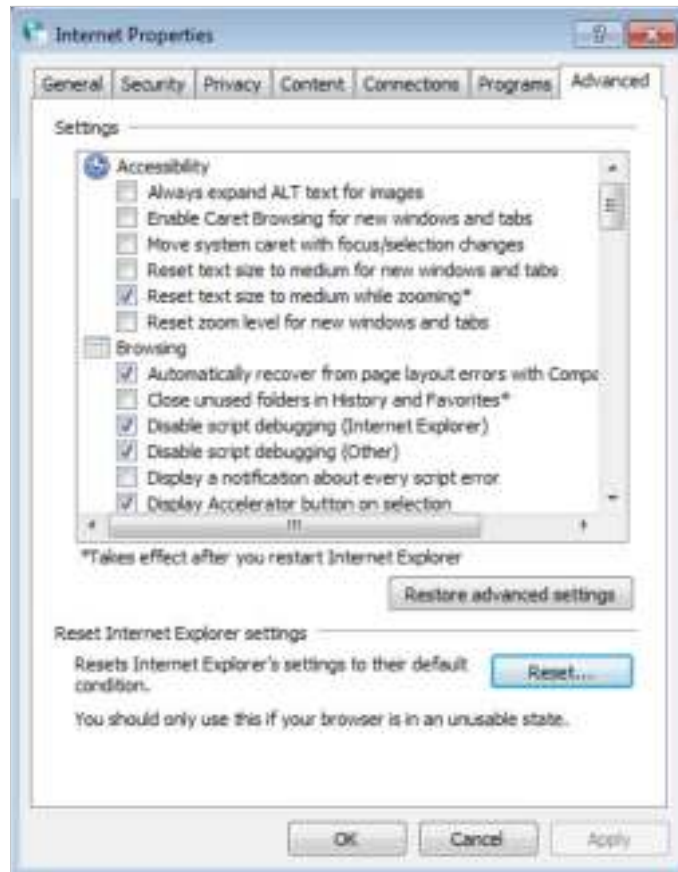

- Use another web browser or computer and log in again.
- Reset the router to factory default settings: With the router powered on, press and hold the WPS/RESET button on the rear panel of the router until the Power LED starts flashing.

■ Note: You'll need to reconfigure the router to surf the Internet once the router is reset.

Open a web browser and log in again. If login fails, please contact the technical support.

T4. What can I do if I cannot access the Internet?

1. Verify that your SIM card is an LTE, WCDMA or GSM card.
2. Verify that your SIM card is in your ISP's service area.
3. Verify that your SIM card has sufficient credit.
4. Check the LAN connection:
Open a web browser and enter <http://tplinkmodem.net> or <http://192.168.1.1> in the address bar. If the login page does not appear, refer to T3 and then try again.
5. Check your ISP parameters:
 - 1) Open a web browser and log in to the web management page.

- 2) Go to [Advanced](#) > [Network](#) > [Internet](#) to verify the parameters (including the APN, Username and Password) provided by your ISP are correctly entered. If the parameters are incorrect, click [Create Profile](#) and enter the correct parameters, then select the new profile from the Profile Name list.
6. Check the PIN settings:
 - 1) Open a web browser and log in to the web management page.
 - 2) Go to [Advanced](#) > [Network](#) > [PIN Management](#) to verify if PIN is required. If it is, enter the correct PIN provided by your ISP or disable [PIN Lock](#), and click [Save](#).
7. Check the Data Limit:
 - 1) Open a web browser and log in to the web management page.
 - 2) Go to [Advanced](#) > [Network](#) > [Data Settings](#) to verify if the [Total Used](#) exceeds the [Total Allowance](#) or if the [Monthly Used](#) exceeds the [Monthly Allowance](#). If it does, click [Correct](#) and set [Total/Monthly Used](#) to 0 (zero), or disable [Data Limit](#).
8. Check the Mobile Data:
 - 1) Open a web browser and log in to the web management page.
 - 2) Go to [Advanced](#) > [Network](#) > [Internet](#) to verify that [Mobile Data](#) is enabled. If not, toggle it On to access the Internet.
9. Check the Data Roaming:
 - 1) Confirm with your ISP if you are in a roaming service area. If you are, open a web browser and log into the web management page.
 - 2) Go to [Advanced](#) > [Network](#) > [Internet](#) to verify that [Data Roaming](#) is enabled. If not, toggle it On to access the Internet.

T5. What should I do if my Internet speed is slow?

1. Make sure you are inside a network coverage area.
2. Relocate your router and your computer to have a better signal reception – you may be in or near a structure that is blocking the signal. Obstacles (for example, walls, ceilings, and furniture) between the router and other wireless devices decreases the signal strength.
3. The 2.4GHz Wi-Fi network may be interfered. It is recommended to use the 5GHz Wi-Fi network if your devices support it. Visit <http://tplinkmodem.net>, and log in with the password you set for the router. Go to [Basic](#) > [Wireless](#) page and enable [Wireless Network 5GHz](#). Then you can search the SSID of your 5GHz wireless network on your wireless devices and connect to it.

T6. How to use the router as a regular wireless router to share my Internet ?

The router support two operation modes, 3G/4G Router Mode and Wireless Router mode. If you already have a modem or your Internet comes via an Ethernet cable from the wall, you can set up the router as a regular wireless router to share the Internet.

1. Connect your router's LAN4/WAN port to the modem or the network port.
2. Visit <http://tplinkmodem.net>, and log in with password you set for the router.
3. Go to [Advanced](#) > [Operation Mode](#) page.

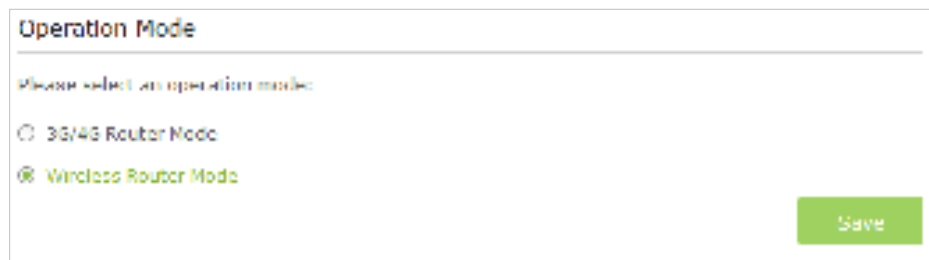

4. Select the [Wireless Router Mode](#) option and click [Save](#) to make the settings effective.

Note:

In wireless router mode, you can use 3G/4G network as a backup solution for Internet access. When [3G/4G Backup](#) is enabled, your router will be directly connected to the 3G/4G network when the original network service fails. To enable or disable [3G/4G Backup](#), go to [Advanced](#) > [Network](#) > [Internet](#).

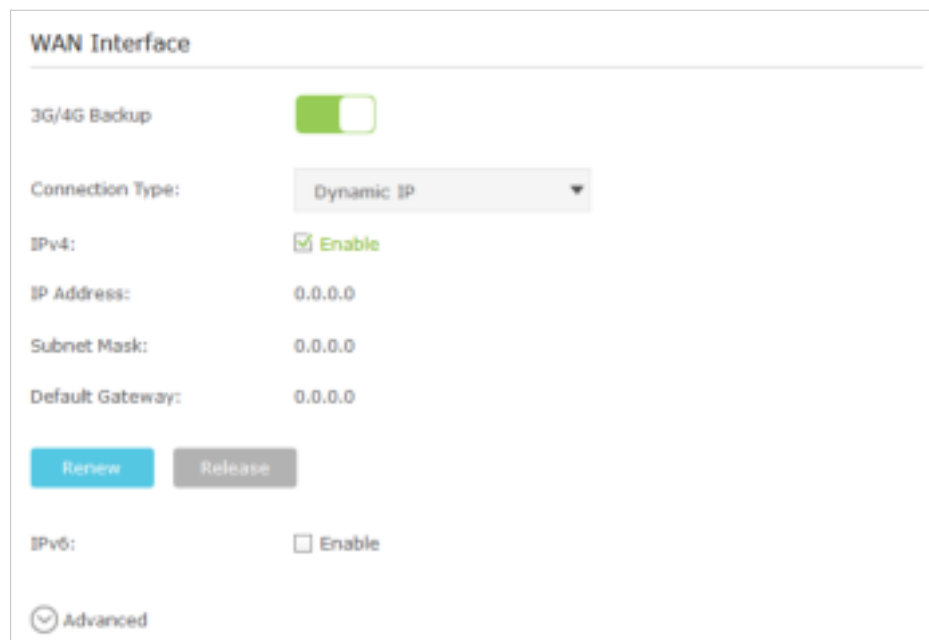

T7. How to use the WDS Bridging function to extend my wireless network?

My house covers a large area. The wireless network coverage of the router I'm using (the root router) is limited. I want to use an extended router to extend the wireless network of the primary router. Follow the steps to configure the router.

1. Visit <http://tplinkmodem.net>, and log in with password you set for the router.
2. Configure the [LAN IP address](#) of the router in the same subnet as the root router. For example, if the IP address of the root router is 192.168.0.1, the IP address of the extended router should be from 192.168.0.2 to 192.168.0.254.).
3. Go to [Advanced](#) > [Wireless](#) > [Advanced Settings](#) page and locate the [WDS](#) section.
4. Select the wireless network 2.4GHz or 5GHz appropriate to your needs and select the checkbox to enable the [WDS Bridging](#) function.

5. Click [Survey](#) to scan all the AP devices and choose the root AP to be bridged.

ID	MAC Address	SSID	Signal strength	Channel	Encryption	Connect
1	E0:05:C5:30:02:46	TP-LINK_0148_5G	14	36	Encrypted	
2	30:85:C2:33:97:81	TP-LINK_5GHz_0000	6	38	Encrypted	
3	28:04:29:57:10:48	TP-LINK_Extender_5GHz	9	36	None	
4	00:0A:EB:13:78:02	TP-LINK_Extender_5GHz	13	36	None	

6. Click the connect icon and then the SSID and MAC will be auto-populated. Configure the Security settings as the AP you choose to be bridged.

7. Click [Save](#) to make the settings effective.
8. Go to [Advanced](#) > [Network](#) > [LAN Settings](#) page to disable DHCP.

Now, the root's wireless network is extended and you can use the router's SSID and password to enjoy the network.

■ **Note:** The extended router (4G LTE router) can have different SSID and password from the root router, you can change your router's SSID and password on [Basic](#) > [Wireless](#) page.

T8. What can I do if I cannot find my wireless network or I cannot connect the wireless network?

- **If you fail to find any wireless network, please follow the steps below:**
 1. Make sure the wireless function is enabled if you're using a laptop with built-in wireless adapter. You can refer to the relevant document or contact the laptop manufacturer.
 2. Make sure the wireless adapter driver is installed successfully and the wireless adapter is enabled.

On Windows 7

- 1) If you see the message [No connections are available](#), it is usually because the wireless function is disabled or blocked somehow;

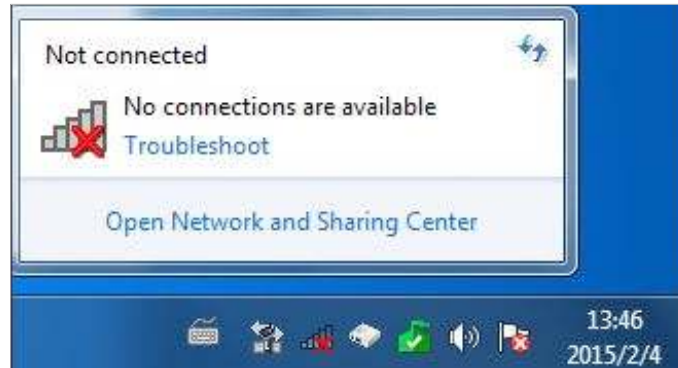

- 2) Clicking on [Troubleshoot](#) and windows might be able to fix the problem by itself.

On Windows XP

- 1) If you see the message [Windows cannot configure this wireless connection](#), this is usually because windows configuration utility is disabled or you are running another wireless configuration tool to connect the wireless.



- 2) Exit the wireless configuration tool (the TP-LINK Utility, for example);
- 3) Select and right click on [My Computer](#) on desktop, select [Manage](#) to open Computer Management window;
- 4) Expand [Services and Applications](#) > [Services](#), find and locate [Wireless Zero Configuration](#) in the Services list on the right side;



5) Select **Wireless Zero Configuration**, right click it, and then select **Properties**;

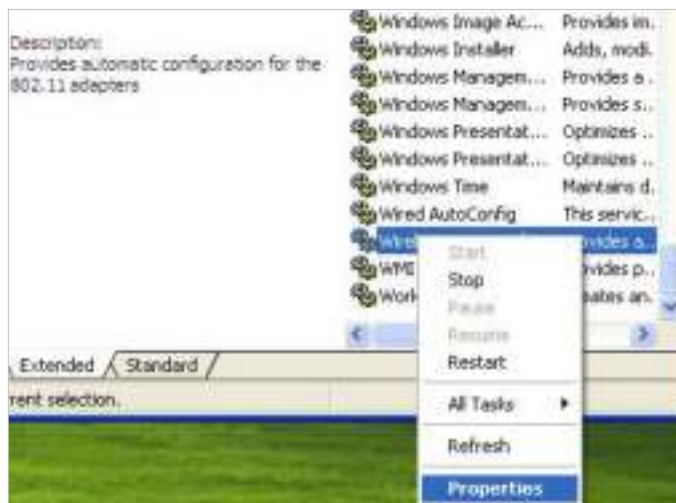

6) Change **Startup type** to **Automatic**, click on Start button and make sure the Service status is Started. And then click **OK**.

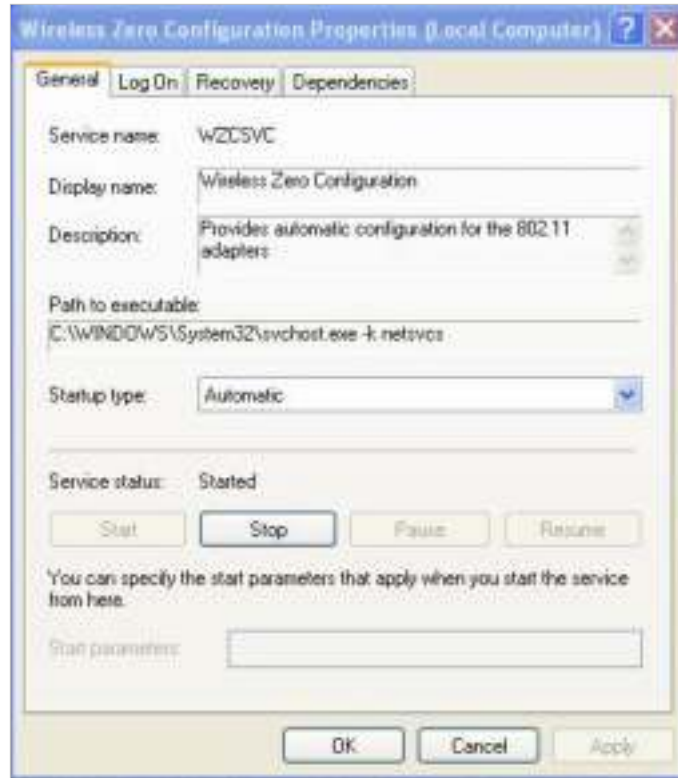

7) Connect to wireless network.

➤ **If you can find other wireless network except your own, please follow the steps below:**

1. Check the WLAN LED indicator on your router;
2. Make sure your computer/device is still in the range of your router/modem, move closer if it is currently too far away;
3. Go to [Advanced](#) > [Wireless](#) > [Advanced Settings](#) page, and check the wireless router settings. Double check your Wireless Network Name, and make sure the SSID is not hidden;
4. Connect to wireless network.

➤ **If you can find your wireless network but fail to connect, please follow the steps below:**

1. Authenticating problem, password mismatch.
 - 1) Sometimes it will ask you to type in a PIN number when you connect to the wireless network for the first time. This PIN number is different from the Wireless Password/Network Security Key, usually you can only find it on the back of your wireless router/modem;



- 2) If you cannot find the PIN or PIN failed, you may choose [Connecting using a security key instead](#), and then type in the Network Security Key/Wireless Password;



- 3) If it continues saying network security key mismatch, it is suggested to confirm the wireless password on your wireless router/modem;

■ Note: Wireless password/Network Security Key is case-sensitive.



- 4) Connect to wireless network.
2. Windows was unable to connect to XXXX /Cannot join this network/Taking longer than usual to connect to this network.

- 1) Check the wireless signal strength of your network, if it is weak (1~3 bars), please move the router closer and try again;
- 2) Change the wireless Channel of the router to 1,6,or 11 to reduce interference from other networks;
- 3) Re-install or update the driver for your wireless adapter of the computer;
- 4) Connect to wireless network.

COPYRIGHT & TRADEMARKS

Specifications are subject to change without notice. **TP-LINK** is a registered trademark of TP-LINK TECHNOLOGIES CO., LTD. Other brands and product names are trademarks or registered trademarks of their respective holders.

No part of the specifications may be reproduced in any form or by any means or used to make any derivative such as translation, transformation, or adaptation without permission from TP-LINK TECHNOLOGIES CO., LTD. Copyright © 2016 TP-LINK TECHNOLOGIES CO., LTD. All rights reserved.

<http://www.tp-link.com>

CE Mark Warning



This is a class B product. In a domestic environment, this product may cause radio interference, in which case the user may be required to take adequate measures.

Restricted to indoor use.

RF Exposure Information

This device meets the EU requirements (1999/5/EC Article 3.1a) on the limitation of exposure of the general public to electromagnetic fields by way of health protection. The device complies with RF specifications when the device used at 20 cm from your body.

Korea Warning Statements:

당해 무선설비는 운용중 전파혼신 가능성이 있음.

NCC Notice & BSMI Notice:

注意！

依據 低功率電波輻射性電機管理辦法

第十二條 經型式認證合格之低功率射頻電機，非經許可，公司、商號或使用者均不得擅自變更頻率、加大功率或變更原設計之特性或功能。

第十四條 低功率射頻電機之使用不得影響飛航安全及干擾合法通行；經發現有干擾現象時，應立即停用，並改善至無干擾時方得繼續使用。前項合法通信，指依電信規定作業之無線電信。低功率射頻電機需忍受合法通信或工業、科學以及醫療用電波輻射性電機設備之干擾。

減少電磁波影響，請妥適使用。

電磁波曝露量MPE標準值 $1\text{mW}/\text{cm}^2$ ，本產品使用時建議應距離人體 21cm 。

安全諮詢及注意事項

- 請使用原裝電源供應器或只能按照本產品注明的電源類型使用本產品。
- 清潔本產品之前請先拔掉電源線。請勿使用液體、噴霧清潔劑或濕布進行清潔。
- 注意防潮，請勿將水或其他液體潑灑到本產品上。
- 插槽與開口供通風使用，以確保本產品的操作可靠並防止過熱，請勿堵塞或覆蓋開口。
- 請勿將本產品置放於靠近熱源的地方。除非有正常的通風，否則不可放在密閉位置中。
- 請不要私自打開機殼，不要嘗試自行維修本產品，請由授權的專業人士進行此項工作。



Продукт сертифіковано згідно с правилами системи УкрСЕПРО на відповідність вимогам нормативних документів та вимогам, що передбачені чинними законодавчими актами України.





Safety Information

- When product has power button, the power button is one of the way to shut off the product; when there is no power button, the only way to completely shut off power is to disconnect the product or the power adapter from the power source.
- Don't disassemble the product, or make repairs yourself. You run the risk of electric shock and voiding the limited warranty. If you need service, please contact us.
- Avoid water and wet locations.
- Adapter shall be installed near the equipment and shall be easily accessible.
- The plug considered as disconnect device of adapter.
-  Use only power supplies which are provided by manufacturer and in the original packing of this product. If you have any questions, please don't hesitate to contact us.

For EU/EFTA, this product can be used in the following countries:

AT	BE	BG	CH	CY	CZ	DE	DK
EE	ES	FI	FR	GB	GR	HR	HU
IE	IS	IT	LI	LT	LU	LV	MT
NL	NO	PL	PT	RO	SE	SK	SI

Explanation of the symbols on the product label

Symbol	Explanation
	DC voltage
	<p>RECYCLING</p> <p>This product bears the selective sorting symbol for Waste electrical and electronic equipment (WEEE). This means that this product must be handled pursuant to European directive 2012/19/EU in order to be recycled or dismantled to minimize its impact on the environment.</p> <p>User has the choice to give his product to a competent recycling organization or to the retailer when he buys a new electrical or electronic equipment.</p>