



Rollei Action Camera 410

User Manual

Table of contents

Contents

| | |
|---|----|
| Table of Contents..... | 1 |
| Safety Precautions..... | 2 |
| What’s in the Box..... | 3 |
| Product Diagram..... | 4 |
| Remote Diagram..... | 5 |
| Setup Your Rollei Actioncam 410..... | 6 |
| Video Mode..... | 7 |
| Video Settings..... | 8 |
| General Settings..... | 10 |
| Picture Mode..... | 13 |
| Using Your Rollei Actioncam 410..... | 16 |
| Playback Mode..... | 18 |
| Wi-Fi Setup..... | 19 |
| Saving and Viewing Options..... | 20 |
| Installing Rollei Actioncam 410 into waterproof case..... | 21 |
| FAQ..... | 22 |
| Specifications..... | 23 |
| System Requirements..... | 23 |
| Declaration..... | 24 |
| License statement..... | 25 |

Safety Precautions

Before using the Rollei Actioncam 410, please ensure you read and understand the safety precautions.

- Do not attempt to open the case of the camera or modify it in any way. If the camera has been opened, the warranty will be void. Maintenance and repairs can only be performed by Rollei.
- Keep the camera away from water and other liquids (unless used in the waterproof case). Do not handle the Rollei Actioncam 410 with wet hands (unless used in the waterproof case). This may cause the camera to malfunction.
- Recharge the battery using the micro USB Connector.
- The Rollei Actioncam 410 should not be used if outside the temperature range of $-10^{\circ}\text{C} \sim 60^{\circ}\text{C}$ ($14^{\circ}\text{F} \sim 140^{\circ}\text{F}$).
- DO NOT drop the Rollei Actioncam 410.
- Avoid placing heavy objects on the Rollei Actioncam 410.
- Do not dispose of this unit in domestic waste.

What's in the box

Please ensure the product package has the following contents:

- | | |
|---------------------------|---------------------------|
| A Rollei Actioncam 410 | H Flat mount |
| B Waterproof case | I 3M adhesive |
| C Portable camera frame | J Lock Bolt |
| D Roll bar mount for bike | K Helmet strap |
| E Quick release mount | L Knuckle |
| F Helmet mount | M USB cable |
| G Curved mount | N Wrist Remote controller |

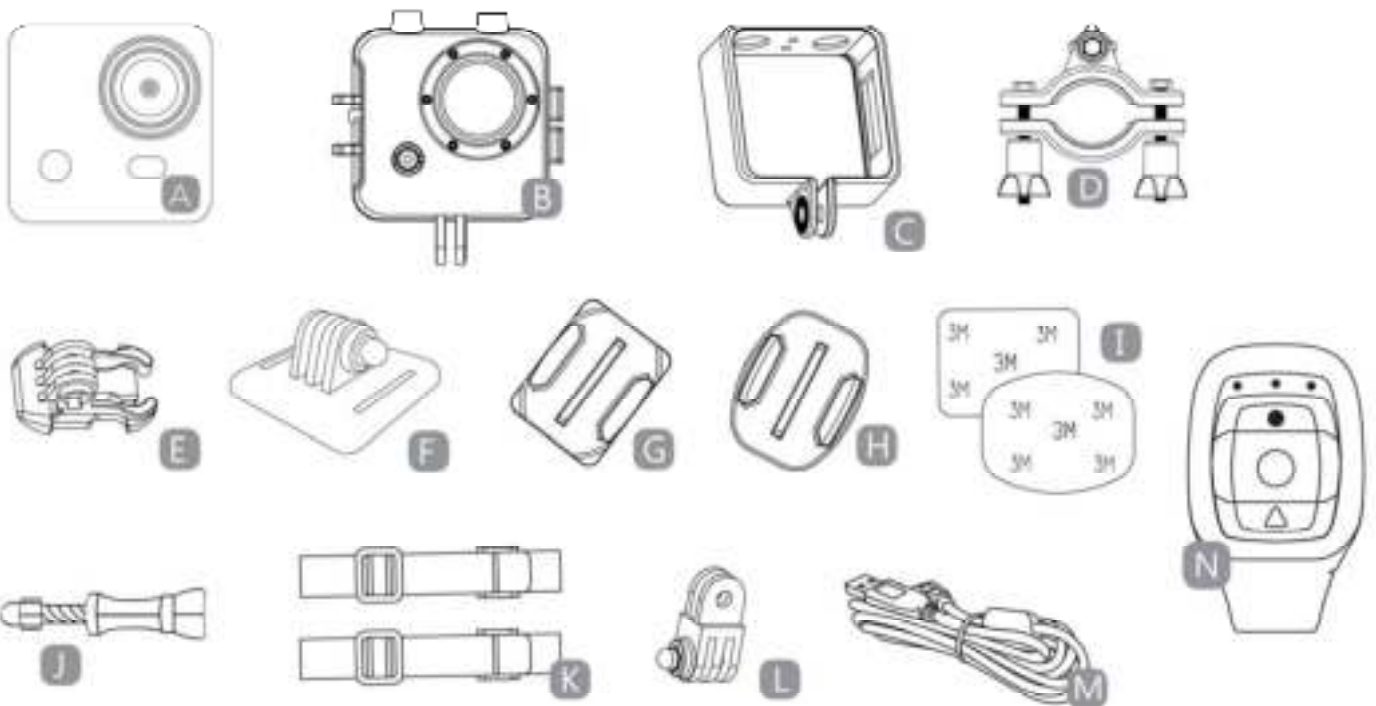

Product Diagram

A WI-FI Activation (Down select)

B LED power indicator

C LCD screen

D SHOOT (menu select)

E Microphone

F POWER (and menu)

G USB interface

H Micro SD card port

I Mini HDMI interface

J Removable Li-Battery

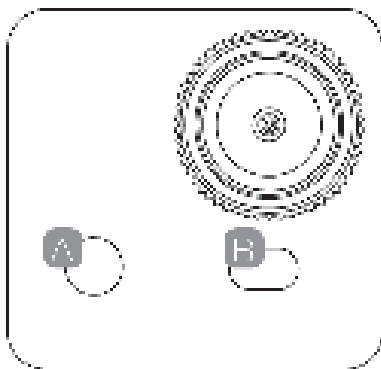

Front

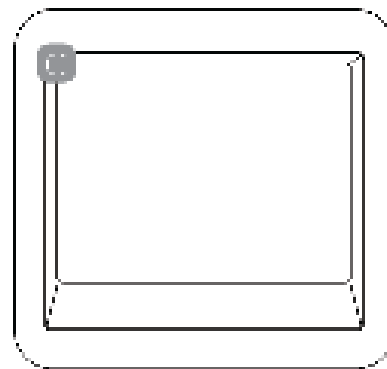

Back

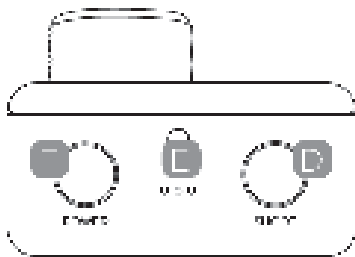

Top

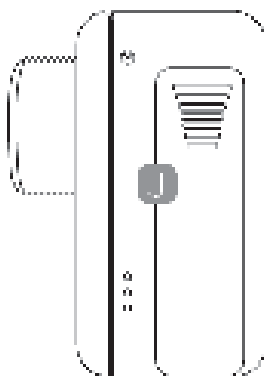

Left Side

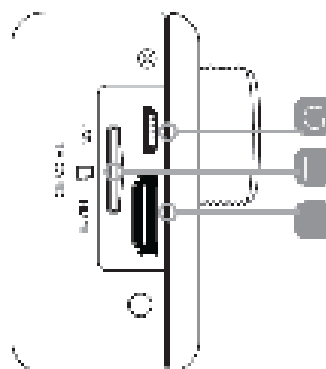

Right Side

Remote Diagram

Please note: with the remote controller you cannot turn the camera on. Please ensure the camera is switched on before using the remote.

- A LED Indicators
- B Shoot Photo
- C Record Video
- D Power Off
- E Micro USB Charge port on the back of remote



Press and hold the “Power Off” button around 4sec. to turn the camera off.

To use the remote, please code first before power on the camera.

Coding procedures:

1. Press and hold the “Picture” & “Video” keys of the remote at the same time, then turn the camera on;
2. When the camera enters into the real live interface, release the “Picture” & “Video” keys;
3. The middle blue indicator lights up, then the coding is finished.

Note:

- Please keep holding the “Picture” & “Video” keys during coding;
- Only need to code once, afterwards the camera will recognize automatically;
- Wi - Fi function & remote controller can not be used simultaneously.

Setup Your Rollei Actioncam 410

Turn the camera on- press and hold the POWER button for several seconds.

When the camera is on, the Rollei logo will appear on the screen and the three red LED lights will glow red. The camera is now in video mode.



Red LED light



Video Mode



*Video mode screen

Once the camera is turned on, it goes to the video capture mode by default.

Press SHOOT button to start recording. When the recording starts, you will see the red lights start flashing. To end recording, press the SHOOT button again.

To enter the Settings menu, press the POWER button (press and release immediately-if it is held too long the camera will switch off).

Note: The Setup menu is depending on the active mode. If the video mode is active, it will display video capture settings or if the Picture mode is active, it will display the Image capture settings.

By default, video mode is the active mode when you turn the device on.

Video Settings



Video Settings Screen

This allows user to adjust Video quality settings.

Navigation: Use Wi-Fi button to navigate, SHOOT button to Enter/Confirm selection, POWER button to go back.

Resolution

This allows user to set the recording video resolution:

- 1080P 60fps
- 1080P 30fps
- 720P 120fps
- 720P 60fps

Video Looping

This allows user to set record duration

- OFF-In this mode, camera will generate new file on every 25 mins
- 1 Min-In this mode, camera will generate new file on every 1 mins
- 3 Mins-In this mode, camera will generate new file on every 3 mins

- 5 Mins-In this mode, camera will generate new file on every 5 mins

White Balance

Factory default is Auto. If you switch Auto OFF, remember to adjust when lighting conditions change.

Following pre-set modes are also available

Daylight, Cloudy, Tungsten, Fluor

Microphone

SELECT Outdoor or Car to record in different scenes with better audio effect,

SELECT OFF for video only.

Date Stamp

- Off: to turn off displaying date stamp on captures
- Date: to display date on captures
- Date & Time: to display date& time on captures

General Settings



General Settings Screen (Page 1)

This allows user to adjust the general device settings.

To enter General Settings, enter the Settings menu first by pressing POWER button, then press and hold the SHOOT button for 3secs

Navigation: Use Wi-Fi button to navigate, SHOOT button to Enter/Confirm selection, POWER button to go back.

Auto LCD Off

This will determine if the LCD will turn off after 1 min, 3 min or 5 min. Press any key to turn the screen on.

Select OFF to keep the screen always ON.

Auto Power Off

To set Auto Power off function

Date & Time

This allows user to adjust the date &time.

Note: Use the Wi-Fi button to change the date and time, use SHOOT button to confirm. The date is entered in Year/Month/Day format. Time is based on a 24hr clock.

Language

To select the device language.

Light Frequency

Selecting the correct light frequency will avoid the possibility for strobing.



General Setting Screen (Page 2)

Screen rotation

To rotate the screen

Timelapse

This feature allows you to set the intervals/frequency at which a frame is captured. You can set the time Frequency here.

System

- Factory Reset; to reset the camera to factory default.
- System Info; to check the firmware version.
- Card Info; to see the SD card information.

Wi-Fi Password

Set up your new Wi-Fi Password.

Note : The default Wi-Fi Password is 1234567890.

Use the Wi-Fi button to navigate, use SHOOT button to confirm.

Wi-Fi SSID

Set up your new Wi-Fi name.

Note: Use the Wi-Fi button to navigate, use SHOOT button to confirm. The name is entered in “ Wi-Fi_CAM_000” format, you can only change the last three numbers which are displayed with cycle numbers.



General Setting Screen (Page 3)

Format

This is to format the card. Choosing to format the card will permanently erase all data on the card.

Picture Mode

This mode will allow users to take snapshots



Picture Mode Screen

To activate this mode:

- Turn the camera on
- Press and hold the SHOOT button for 3secs
- You will see P() on top left corner of the screen
- Press SHOOT button to take snapshots

Picture Settings



Picture Setting Screen 1

To enter the SETUP menu for Picture Mode, press POWER button (press and release immediately-if it is held too long the camera will switch off).

Resolution

To select the image resolution.

Quality

To set the image quality.

Metering

Metering mode refers to the way in which a camera determines the exposure.

White Balance

Factory default is Auto. If you switch Auto OFF, remember to adjust when lighting conditions change.

ISO

This is the measurement of how sensitive a digital camera's sensor is to light.



Picture Setting Screen 2

Exposure

This allows user to set the light exposure value.

Self-timer

This allows user to set the timer for auto image capture.

Date Stamp

- Off: to turn off displaying date stamp on captures

- Date: to display date on captures
- Date & Time: to display date& time on captures

Using Your Rollei Actioncam 410

Preparation

Charging the battery

Before using the Rollei Actioncam 410 for the first time you should fully charge the battery.

Procedure:

1. Connect Rollei Actioncam 410 to a computer (or other USB power source) using the USB cable (provided).

2. A: If the Camera is on when charging, 3 red lights will glow red until the battery is fully charged.

B: Only one red light will glow red if the camera is off when charging.

3. A completely flat battery will take about 5 hours to be fully charged. The red indicator lights will turn off when the battery is fully charged.

When the battery is nearly running flat, some functions of the camera will be not allowed to use, such as Wifi function.

Insert the Micro SD*

- It is recommended to use Class 6 (or higher) Micro SD card to shoot smooth

video files. Lower class cards may cause the video to be blurry or jerky.

- There is only one correct direction to insert the Micro SD card into the slot.

Do not force the card into the card slot, as it may damage both the camera and the card.

- It is recommended to format new cards of cards that have been previously used in other cameras. To format the Micro SD card:

Note: Formatting the card will permanently delete the contents.

Video Recording

Once the camera is turned on, it goes to the video capture mode by default.

Press SHOOT button to start recording. When the recording starts, you will see the red lights start flashing. To end recording, press the SHOOT button again.

Image Capturing

To take snapshot, you will need to switch the camera from video mode to image capture mode. To enter this mode:

- Turn the camera on
- Press and hold the SHOOT button for 3secs
- You will see  on top left corner of the screen

Playback Mode

Navigation: Use Wi-Fi button to navigate, SHOOT button to Enter/Confirm selection, POWER button to go back.

This will allow you to watch the captured videos & images. Enter the Picture mode first, then press and hold the SHOOT button for 3secs.

To watch a captured video, go to VIDEO and select the file.

To view a captured image, go to IMAGE.

To view a loop recording, go to LOOP

To delete the image, select the file and Press POWER button. You will see delete option there. You can select the option to delete a single file or all files.

To exit Playback mode press and hold the SHOOT button to return to the normal recording mode.

Connecting to TV

You can display the camera LCD screen on a TV screen.

Note: You will need a Mini HDMI to HDMI cable.

- Turn the camera on

- Connect Mini HDMI end to the port on camera and HDMI end to HDMI port on the TV
- Select the right source on the TV
- Turn the camera on

Wi-Fi Setup

The Rollei Actioncam 410 allows full camera control, live previewing and playback of photos/videos on most Smartphones and Tablets.

1. Download the App “Rollei 400/410” from “Google Play” or from the Apple “App Store”.



Rollei 400/410

2. Activate Wi-Fi on your Rollei Actioncam 410 by pressing Wi-Fi button.
3. Go to the Wi-Fi settings on your Phone, you will see Wi-Fi_CAM_000 in the list of available Wireless networks.

Note: You can change the Wi-Fi name in the menu setting.

4. Connect your Phone to the “Rollei 400/410” via Wi-Fi.
5. The default Wi-Fi Password for the Rollei Actioncam 410 is:

1234567890

Note: You can change the Wi-Fi password in the menu setting.

6. Open the app “Rollei 400/410”

Important: Before connecting camera via Wi-Fi, you need to download the “Rollei 400/410” App on your smart phone or tablet.

App Interface Diagram

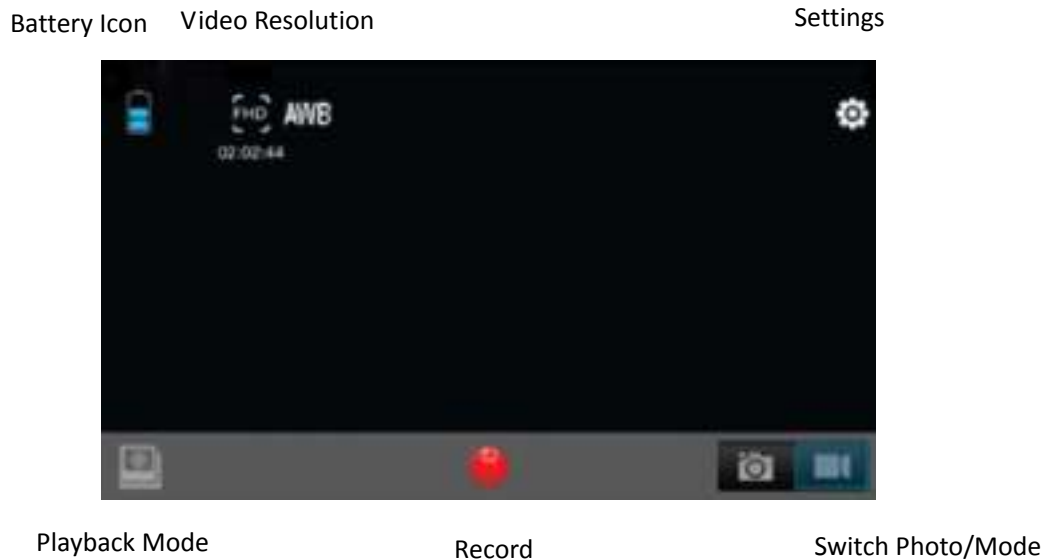

Note: To watch the recorded videos on your phone, you need to download them first.

Saving and Viewing Options

Transferring files to PC

Use the USB cable supplied (M) to connect the camera to your computer.

The camera LCD will display MSDC icon and your computer will see your camera as an external storage device. Alternatively you can remove the Micro SD card and use a card reader (not included) to achieve the same result.

1. Select the file(s) you want to transfer to your computer by highlighting them.

2. Either drag the files to the desired place on your computer (this will make a copy of the file on your computer) OR right-click the file, select “Copy” and right-click in the desired place in your computer and select “Paste”.

Note: You can also transfer entire folders of pictures / videos to your computer.

Installing Rollei Actioncam 410 into waterproof case

The Rollei Actioncam 410 is designed to be used in the waterproof case (B).

Before inserting the Rollei Actioncam 410 in the case, select video or picture mode.

Notes:

- Ensure the case is dry and clean.
- Insert Rollei Actioncam 410, ensuring the lens fits neatly in the lens cavity.
- Close the security latch.
- The Rollei Actioncam 410 can be mounted using the accessories provided.

FAQ

Q. Why are the red LEDs flickering?

A. The battery is running low. You must recharge the camera.

Q. My Rollei Actioncam 410 will NOT turn on. Why?

A. The battery is flat. You need to recharge it (full recharge from flat will take about 5 hours).

Q. My Rollei Actioncam 410 turns off automatically. Why?

A: The battery is running flat or you set auto power off function.

Q. Videos and pictures are blurred. Why?

A: The lens may be dirty. Clean the lens first.

Q. My Rollei Actioncam 410 cannot be seen by my computer. Why?

A: Try a different USB cable or different USB port.

Q. My Rollei Actioncam 410 cannot connect the Wi-Fi. Why?

A: The battery maybe runs flat. Charge the battery first.

Specifications

| | |
|---------------|--|
| Underwater | Down to 30m (with waterproof casing) |
| Sensor | 4.0 megapixels CMOS sensor |
| Resolution | Video: 1080p@60fps, 1080p@30fps, 720p@120fps, 720p@60fps |
| | Still photo: 4 megapixels (12 megapixels interpolated) |
| Storage type | Micro SD card up to 32GB (not included) |
| Lens | 150°-view fixed lens |
| Lens aperture | F/2.8 |
| Lens focus | 0.5m to infinity |
| Shutter speed | 1/30 to 1/2000 sec |
| Video Looping | OFF, every 1 min, every 3 min, every 5 min |
| Sensitivity | Automatic ISO 100-200 |
| Microphone | Built-in |
| Display | 2" TFT LCD |
| Format | Video: MOV H.264 |
| | Still photo: JPEG |
| Power supply | 3.7V/1000mAh removable Li-Battery |
| Battery life | Video: about 1.5 hours without Wi-Fi |
| Dimensions | 54x37x51mm |
| Casing | 49.5x76x84mm |

System Requirements

| | |
|------------------|-------------------------------------|
| Operating System | Windows XP / Vista / 7 / 8 / MAC OS |
| App Requirements | Apple iOS & Android |
| Interface | HDMI (HDMI cable not included) |
| | High speed USB 2.0 |

Declaration

The Manufacturer hereby declares that the CE marking was applied to the Rollei Actioncam 410 in accordance with the basic requirements and other

2011/65/EC RoHS Directive

2004/108/EC Low Voltage Directive

1999/5/EG R&TTE Directive

2006/95/EEC LVD Directive

2009/125/EG EuP Directive

2002/96/EG WEEE Directive



The EC Declaration of Conformity can be requested from the address specified on the Warranty card.

License Statement

The software used in this product is licensed subject to a license pursuant to the GNU – General Public License conditions. We expressly draw attention to the fact that under the GNU – General Public License conditions no liability is accepted.

The starting point for the software is the software published online at

<http://sg-gpl.net/>

The software listed there is licensed pursuant to the GNU – General Public License conditions.

Device-related changes have been made to this software for the product in question. The source text of the software implemented in the product in question can be obtained in response to an enquiry sent to the e-mail address

info@rollei.com

In this instance your e-mail must contain details of what the relevant product is, the relevant serial number and documentary evidence of your commercial source of supply as well as documentary evidence of the date on which the product was purchased from the trade source of supply. We guarantee supply

of the source text of the implemented software for a period of at least three years from date of purchase from the trade source of supply where the trade source of supply has sourced the product from us directly or via strictly trade-only dealers.