

ONKYO

LS-T30

TV Speaker System

Instruction Manual

Control Reference Guide.....	4
Placement	7
Connecting to a TV.....	8
Listening to TV	9
Using a TV Remote Controller.....	11
Playing via Bluetooth Connection	12
Troubleshooting	13
Supplied Accessories	15

Thank you for purchasing an Onkyo product. Please read this manual thoroughly before making connections and plugging in your new Onkyo product.

Following the instructions in this manual will enable you to obtain optimum performance and listening enjoyment from your new product.

Please retain this manual for future reference.



Safety precautions

WARNING:

TO REDUCE THE RISK OF FIRE OR ELECTRIC SHOCK, DO NOT EXPOSE THIS APPARATUS TO RAIN OR MOISTURE.

CAUTION:

TO REDUCE THE RISK OF ELECTRIC SHOCK, DO NOT REMOVE COVER (OR BACK). NO USER-SERVICEABLE PARTS INSIDE. REFER SERVICING TO QUALIFIED SERVICE PERSONNEL.



WARNING
RISK OF ELECTRIC SHOCK
DO NOT OPEN

AVIS
RISQUE DE CHOC ELECTRIQUE
NE PAS OUVRIR



The lightning flash with arrowhead symbol, within an equilateral triangle, is intended to alert the user to the presence of uninsulated "dangerous voltage" within the product's enclosure that may be of sufficient magnitude to constitute a risk of electric shock to persons.



The exclamation point within an equilateral triangle is intended to alert the user to the presence of important operating and maintenance (servicing) instructions in the literature accompanying the appliance.

Important Safety Instructions

- 1 Read these instructions.
- 2 Keep these instructions.
- 3 Heed all warnings.
- 4 Follow all instructions.
- 5 Do not use this apparatus near water.
- 6 Clean only with dry cloth.
- 7 Do not block any ventilation openings. Install in accordance with the manufacturer's instructions.
- 8 Do not install near any heat sources such as radiators, heat registers, stoves, or other apparatus (including amplifiers) that produce heat.
- 9 Do not defeat the safety purpose of the polarized or grounding-type plug. A polarized plug has two blades with one wider than the other. A grounding type plug has two blades and a third grounding prong. The wide blade or the third prong are provided for your safety. If the provided plug does not fit into your outlet, consult an electrician for replacement of the obsolete outlet.
- 10 Protect the power cord from being walked on or pinched particularly at plugs, convenience receptacles, and the point where they exit from the apparatus.
- 11 Only use attachments/accessories specified by the manufacturer.
- 12 Use only with the cart, stand, tripod, bracket, or table specified by the manufacturer, or sold with the apparatus. When a cart is used, use caution when moving the cart/apparatus combination to avoid injury from tip-over.
- 13 Unplug this apparatus during lightning storms or when unused for long periods of time.
- 14 Refer all servicing to qualified service personnel. Servicing is required when the apparatus has been damaged in any way, such as power-supply cord or plug is damaged, liquid has been spilled or objects have fallen into the apparatus, the apparatus has been exposed to rain or moisture, does not operate normally, or has been dropped.
- 15 Damage Requiring Service Unplug the apparatus from the wall outlet and refer servicing to qualified service personnel under the following conditions:
 - A. When the power-supply cord or plug is damaged,
 - B. If liquid has been spilled, or objects have fallen into the apparatus.
 - C. If the apparatus has been exposed to rain or water.
 - D. If the apparatus does not operate normally by following the operating instructions. Adjust only those controls that are covered by the operating instructions as an improper adjustment of other controls may result in damage and will often require extensive work by a qualified technician to restore the apparatus to its normal operation.
 - E. If the apparatus has been dropped or damaged in any way, and
 - F. When the apparatus exhibits a distinct change in performance this indicates a need for service.
- 16 Object and Liquid Entry
Never push objects of any kind into the apparatus through openings as they may touch dangerous voltage points or short-out parts that

PORTABLE CART WARNING



S3125A

- 17 Batteries
Always consider the environmental issues and follow local regulations when disposing of batteries.
- 18 If you install the apparatus in a built-in installation, such as a bookcase or rack, ensure that there is adequate ventilation. Leave 20 cm (8") of free space at the top and sides and 10 cm (4") at the rear. The rear edge of the shelf or board above the apparatus shall be set 10 cm (4") away from the rear panel or wall, creating a flue-like gap for warm air to escape.

Precautions

- 1 Recording Copyright - Unless it's for personal use only, recording copyrighted material is illegal without the permission of the copyright holder.
- 2 AC Fuse - The AC fuse inside the unit is not user-serviceable. If you cannot turn on the unit, contact your Onkyo dealer.
- 3 Care - Occasionally you should dust the unit all over with a soft cloth. For stubborn stains, use a soft cloth dampened with a weak solution of mild detergent and water. Dry the unit immediately afterwards with a clean cloth. Don't use abrasive cloths, thinners, alcohol, or other chemical solvents, because they may damage the finish or remove the panel lettering.
- 4 Power
WARNING
BEFORE PLUGGING IN THE UNIT FOR THE FIRST TIME, READ THE FOLLOWING SECTION CAREFULLY.
AC outlet voltages vary from country to country. Make sure that the voltage in your area meets the voltage requirements printed on the unit's rear panel (e.g., AC 230 V, 50 Hz or AC 120 V, 60 Hz).
The power cord plug is used to disconnect this unit from the AC power source. Make sure that the plug is readily operable (easily accessible) at all times. For models with [POWER] button, or with both [POWER] and [ON/STANDBY] buttons: Pressing the [POWER] button to select OFF mode does not fully disconnect from the mains. If you do not intend to use the unit for an extended period, remove the power cord from the AC outlet. For models with [ON/STANDBY] button only: Pressing the [ON/STANDBY] button to select Standby mode does not fully disconnect from the mains. If you do not intend to use the unit for an extended period, remove the power cord from the AC outlet.
- 5 Preventing Hearing Loss
Caution
Excessive sound pressure from earphones and headphones can cause hearing loss.
- 6 Batteries and Heat Exposure
Warning
Batteries (battery pack or batteries installed) shall not be exposed to excessive heat as sunshine, fire or the like.
- 7 Never Touch this Unit with Wet Hands - Never handle this unit or its power cord while your hands are wet or damp. If water or any other liquid gets inside this unit, have it checked by your Onkyo dealer.
- 8 Handling Notes
 - If you need to transport this unit, use the original packaging to pack it how it was when you originally bought it.
 - Do not leave rubber or plastic items on this unit for a long time, because they may leave marks on the case.
 - This unit's top and rear panels may get warm after prolonged use. This is normal.
 - If you do not use this unit for a long time, it may not work properly the next time you turn it on, so be sure to use it occasionally.

For U.S. and Canadian models

FCC CAUTION

Changes or modifications not expressly approved by the party responsible for compliance could void the user's authority to operate the equipment.

NOTE:

This equipment has been tested and found to comply with the limits for a Class B digital device, pursuant to part 15 of the FCC Rules. These limits are designed to provide reasonable protection against harmful interference in a residential installation. This equipment generates, uses and can radiate radio frequency energy and, if not installed and used in accordance with the instructions, may cause harmful interference to radio communications. However, there is no guarantee that interference will not occur in a particular installation. If this equipment does cause harmful interference to radio or television reception, which can be determined by turning the equipment off and on, the user is encouraged to try to correct the interference by one or more of the following measures:

- Reorient or relocate the receiving antenna.
- Increase the separation between the equipment and receiver.
- Connect the equipment into an outlet on a circuit different from that to which the receiver is connected.
- Consult the dealer or an experienced radio/TV technician for help.

This device complies with Industry Canada licence exempt RSS standard(s). Operation is subject to the following two conditions: (1) this device may not cause interference, and (2) this device must accept any interference, including interference that may cause undesired operation of the device.

This transmitter must not be co-located or operated in conjunction with any other antenna or transmitter.

RF Exposure Compliance

This equipment complies with FCC/IC radiation exposure limits set forth for an uncontrolled environment and meets the FCC radio frequency (RF) Exposure Guidelines in Supplement C to OET65 and RSS-102 of the IC radio frequency (RF) Exposure rules. This equipment has very low levels of RF energy that it deemed to comply without maximum permissive exposure evaluation (MPE). But it is desirable that it should be installed and operated keeping the radiator at least 20 cm or more away from person's body (excluding extremities: hands, wrists, feet and ankles).

For Canadian Models

NOTE:

CAN ICES-3 B/NMB-3 B

For models having a power cord with a polarized plug:

CAUTION:

TO PREVENT ELECTRIC SHOCK, MATCH WIDE BLADE OF PLUG TO WIDE SLOT, FULLY INSERT.

This device complies with Industry Canada licence-exempt RSS standard(s). Operation is subject to the following two conditions: (1) this device may not cause interference, and (2) this device must accept any interference, including interference that may cause undesired operation of the device.

For British models

Replacement and mounting of an AC plug on the power supply cord of this unit should be performed only by qualified service personnel.

IMPORTANT

The wires in the mains lead are coloured in accordance with the following code:

Blue:	Neutral
Brown:	Live

As the colours of the wires in the mains lead of this apparatus may not correspond with the coloured markings identifying the terminals in your plug, proceed as follows: The wire which is coloured blue must be connected to the terminal which is marked with the letter N or coloured black. The wire which is coloured brown must be connected to the terminal which is marked with the letter L or coloured red.

IMPORTANT

The plug is fitted with an appropriate fuse. If the fuse needs to be replaced, the replacement fuse must approved by ASTA or BSI to BS1362 and have the same ampere rating as that indicated on the plug. Check for the ASTA mark or the BSI mark on the body of the fuse. If the power cord's plug is not suitable for your socket outlets, cut it off and fit a suitable plug. Fit a suitable fuse in the plug.

For European Models

WEEE

<http://www.onkyo.com/manual/weee/weee.pdf>

Declaration of Conformity

We declare, under our sole responsibility, that this product complies with the standards:

- Safety
- Limits and methods of measurement of radio disturbance characteristics
- Limits for harmonic current emissions
- Limitation of voltage changes, voltage fluctuations and flicker
- RoHS Directive, 2011/65/EU
- Hereby, Onkyo Corporation, declares that this LS-T30 is in compliance with the essential requirements and other relevant provisions of Directive 1999/5/EC.

Speaker Precautions

Placement

- The subwoofer cabinet is made out of wood and is therefore sensitive to extreme temperatures and humidity, do not put it in locations subject to direct sunlight or in humid places, such as near an air conditioner, humidifier, bathroom, or kitchen.
- Do not put water or other liquids close to the speakers. If liquid is spilled over the speakers, the drive units may be damaged.
- Speakers should only be placed on sturdy, flat surfaces that are free from vibration. Putting them on uneven or unstable surfaces, where they may fall and cause damage, will affect the sound quality.

- Subwoofer is designed to be used in the upright vertical position only. Do not use it in the horizontal or tilted position.
- If the unit is used near a turntable, CD player or DVD player, howling or slipping of sound may occur. To prevent this, move the unit away from the turntable, CD player or DVD player, otherwise lower the unit's output level.

Use with a TV set

In general, Braun tubes used for color television sets, etc. are extremely sensitive and can be affected even by the magnetism of the earth. If a speaker system is used near them, therefore, discoloring or distortion of pictures will occur. These speakers are not provided with magnetic shielding. If discoloration or distortion occurs, move the speakers apart from the television set.

Input Signal Warning

The speakers can handle the specified input power when used for normal music reproduction. If any of the following signals are fed to them, even if the input power is within the specified rating, excessive current may flow in the speaker coils, causing burning or wire breakage:

- 1 Interstation noise from an untuned FM radio.
- 2 Sound from fast-forwarding a cassette tape.
- 3 High-pitched sounds generated by an oscillator, electronic musical instrument, and so on.
- 4 Amplifier oscillation.
- 5 Special test tones from audio test CDs and so on.
- 6 Thumps and clicks caused by connecting or disconnecting audio cables (Always turn off your amplifier before connecting or disconnecting cables).
- 7 Microphone feedback.



- Par la présente, Onkyo Corporation déclare que l'appareil LS-T30 est conforme aux exigences essentielles et aux autres dispositions pertinentes de la directive 1999/5/CE.
- Por la presente, Onkyo Corporation, declara que este LS-T30 cumple con los requisitos esenciales y otras exigencias relevantes de la Directiva 1999/5/CE.
- Con la presente Onkyo Corporation dichiara che questo LS-T30 è conforme ai requisiti essenziali ed alle altre disposizioni pertinenti stabilite dalla direttiva 1999/5/CE.
- Hiermit erklärt Onkyo Corporation, dass sich das Gerät LS-T30 in Übereinstimmung mit den grundlegenden Anforderungen und den übrigen einschlägigen Bestimmungen der Richtlinie 1999/5/EG befindet.
- Hiebyj verklaer Onkyo Corporation dat het toestel LS-T30 in overeenstemming is met de essentiële eisen en de andere relevante bepalingen van richtlijn 1999/5/EG.
- Härmed förklarar Onkyo Corporation att denna LS-T30 följer de väsentliga kraven och andra relevanta stadgar i Direktiv 1999/5/EC.
- С настоящето, Onkyo Corporation, декларира, че LS-T30 е в съответствие със съществените изисквания и другите приложими разпоредби на Директива 1999/5/ЕО.
- Onkyo Corporation tímto prohlašuje, že LS-T30 splňuje základní požadavky a všechna příslušná ustanovení Směrnice 1999/5/ES.
- Undertegnede Onkyo Corporation erklærer herved, at følgende udstyr LS-T30 overholder de væsentlige krav og øvrige relevante krav i direktiv 1999/5/EF.
- Készletvega kinnítub Onkyo Corporation seadme LS-T30 vastavust direktiivi 1999/5/EÜ põhinõuetele ja nimetatud direktiivist tulenevatele teistele asjakohastele sätetele.
- ΜΕ ΤΗΝ ΠΑΡΟΥΣΑ Ο ΚΑΤΑΣΚΕΥΑΣΤΗΣ Onkyo Corporation ΔΗΛΩΝΕΙ ΟΤΙ ΛS-T30 ΣΥΜΜΟΡΦΩΝΕΤΑΙ ΠΡΟΣ ΤΙΣ ΟΥΣΙΩΔΕΙΣ ΑΠΑΙΤΗΣΕΙΣ ΚΑΙ ΤΙΣ ΛΟΠΙΤΕ ΣΧΕΤΙΚΕΣ ΔΙΑΤΑΞΕΙΣ ΤΗΣ ΟΔΗΓΙΑΣ 1999/5/ΕΚ
- Ar so Onkyo Corporation deklare, ka LS-T30 atbilst Direktivas 1999/5/EK būtiskajām prasībām un citiem ar to saistītajiem noteikumiem.
- Šiuo Onkyo Corporation deklaruoja, kad šis LS-T30 atitinka esminius reikalavimus ir kitas 1999/5/EB Direktivos nuostatas.
- A Onkyo Corporation ezzennel kijelenti, hogy a LS-T30 típusú berendezés teljesíti az alapvető követelményeket és más 1999/5/EK irányelvben meghatározott vonatkozó rendelkezéseket.
- Niniejszym Onkyo Corporation deklaruje że LS-T30 jest zgodny z zasadniczymi wymaganiami i innymi właściwymi postanowieniami Dyrektywy 1999/5/EC.
- Eu, Onkyo Corporation, declaro que o LS-T30 cumpre os requisitos essenciais e outras provisões relevantes da Directiva 1999/5/CE.
- Prin prezenta, Onkyo Corporation, declară că aparatul LS-T30 este în conformitate cu cerințele esențiale și cu alte prevederi pertinente ale Directivei 1999/5/CE.
- Onkyo Corporation tímto vyhlasuje, že LS-T30 a splňa základné požiadavky a všetky príslušné ustanovenia Smernice 1999/5/ES.
- Onkyo Corporation izjavlja, da je ta LS-T30 v skladu z bistvenimi zahtevami in drugimi relevantnimi določili direktive 1999/5/ES.
- Onkyo Corporation vakuuttaa täten että LS-T30 tyypinen laite on direktiivin 1999/5/EY oleellisten vaatimusten ja sitä koskevien direktiivin muiden ehtojen mukainen.
- Här med tyser Onkyo Corporation því yfir að varan LS-T30 er í samræmi við grunnkröfur og aðrar kröfur sem gerðar eru í tilskipun 1999/5/EC.
- Onkyo Corporation erklærer herved at denne LS-T30 er i overensstemmelse med væsentlige krav og andre relevante bestemmelser i direktiv 1999/5/EC.
- Ovime Onkyo Corporation, potvrđuje da je LS-T30 u suglasnosti sa osnovnim zahtjevima i ostalim relevantnim odredbama Direktive 1999/5/EC.

Control Reference Guide

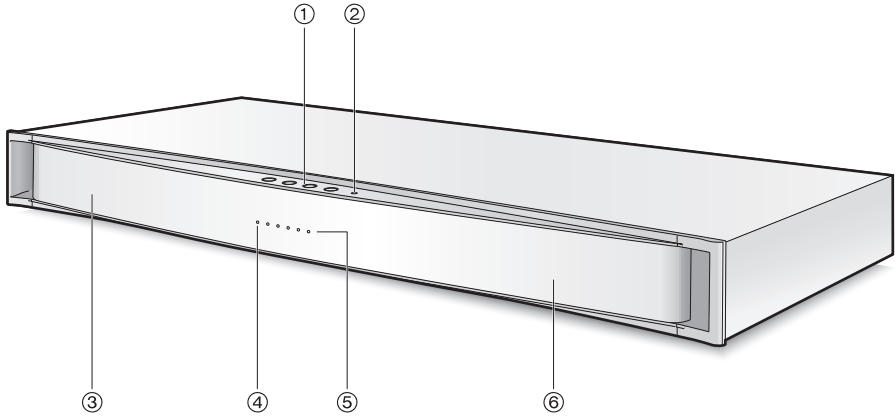

Main unit

- ① **INPUT button:** Switches the input source. Each time the button is pressed, input modes are switched in order of TV→USB (North American models)→Bluetooth →

* Also, switches the power on/standby. Press and hold for approximately 3 seconds to place the device into Standby. Press once to turn the power on.

- ⊕ ⊖ **VOLUME +/- buttons**

- Ⓜ **SOUND MODE button:** Use this button to select the desired sound mode for the playback audio. (→ P10)

- ② **Dolby indicator:** Lights when the digital audio input signal is Dolby Digital.
- ③ **Left channel speaker**
- ④ **Input source indicator:** Lights in accordance with the input source. The indicator lights in white for TV, yellow for USB (North American models), and blue for Bluetooth.

- ⑤ **Status indicators:** Displays the sound mode, volume, and subwoofer level.
- ⑥ **Right channel speaker**

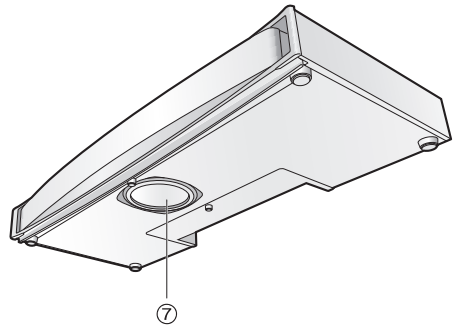

Bottom of the unit

- ⑦ **Subwoofer:** Plays sub-bass frequencies.

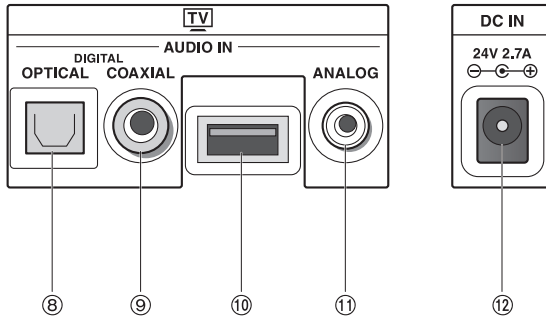

Rear of the unit (terminals)

- ⑧ **OPTICAL jack:** Makes a digital connection to the TV with the supplied optical digital audio cable. ⑧ ⑨ ⑩ are used depending on the audio outputs available on your TV.
- ⑨ **COAXIAL jack:** Makes a digital connection to the TV using a coaxial cable (sold separately).
- ⑩ **USB port:** (North American models) Connects a USB flash memory. (Others) This port is used for service purposes only. Do not use it.
- ⑪ **ANALOG jack:** Makes an analogue connection with the TV using the supplied stereo mini plug cable.
- ⑫ **DC IN terminal:** Connects the supplied AC adapter.

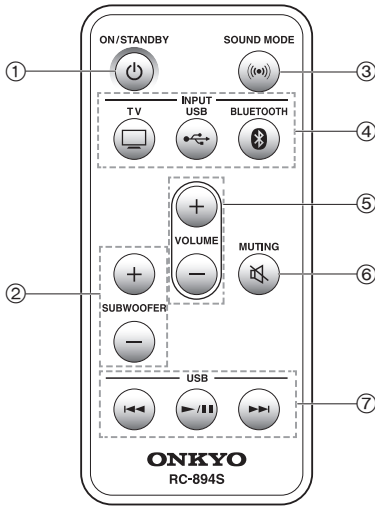

North American models

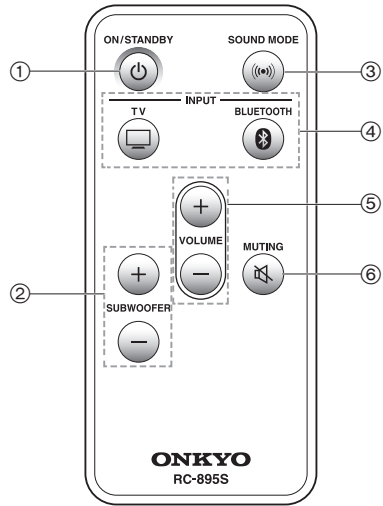

Others

Remote controller

This manual outlines procedures using the remote controller.

- ① **ON/STANDBY button:** Switches the power on/standby.
- ② **SUBWOOFER +/- buttons:** Adjust the subwoofer level.
- ③ **SOUND MODE button:** Use this button to select the desired sound mode for the playback audio.
- ④ **INPUT buttons:** Switches the input source.
- ⑤ **VOLUME +/- buttons**
- ⑥ **MUTING button**
- ⑦ **USB operation buttons (North American models):** Allows operation when the input source is USB.
 - ⏪ plays or pauses playback. ⏩ return to the start of the file being played. Press twice to return to the previous file. ⏭ skip to the next file.

When using the remote controller for the first time, remove the insulation sheet.



Use a CR2025 lithium coin battery for battery replacement.

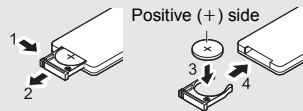

Remote control sensor

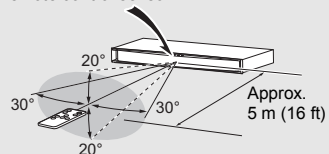

Placement

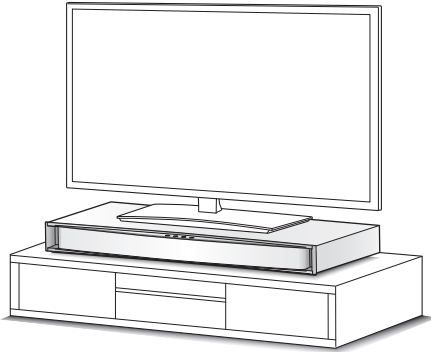

The illustration shows an example of placement. Mount the unit on a firm surface such as the top of a low board. Also, subwoofer is located on the bottom side of the unit. Please take extra care on setting.

TVs meeting the following requirements may be placed on the unit.

- Weight: 60 kg (132.2 lbs) or less
- Width of TV stand: 900 mm (35-7/16") or less
- Depth: 360 mm (14-3/16") or less

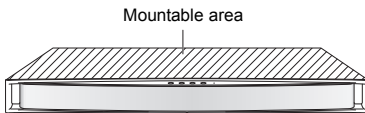

1. Affix the cushioning pads to the bottom of the TV stand.

Using the supplied cushions will allow you to limit the effect of vibrations on the TV.

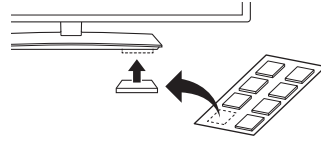

Wrap the TV in a blanket or soft cloth to avoid damage during installation. Installation should be performed by at least two people. When the supplied cushions and the feet of the TV do not match, cut and shape the cushions for use as needed.

2. Place the unit on top of the low board.

The unit is extremely heavy. Be very careful not to trap your fingers when mounting it.



Mount the TV so that it does not protrude from the top face of the unit. If the TV stand protrudes from the top face of the unit, the TV may tip over and cause injury. Also, for TV tip-over/fall prevention measures, see the TV owner's manual.



- If the unit vibrates after placement, mount the supplied vibration prevention cushions under the feet of this unit, and adjust so that it does not vibrate.
- Onkyo is not responsible for accidents or damage caused by improper installation, improper cushion attachment, improper use or natural calamity, etc.

Connecting to a TV

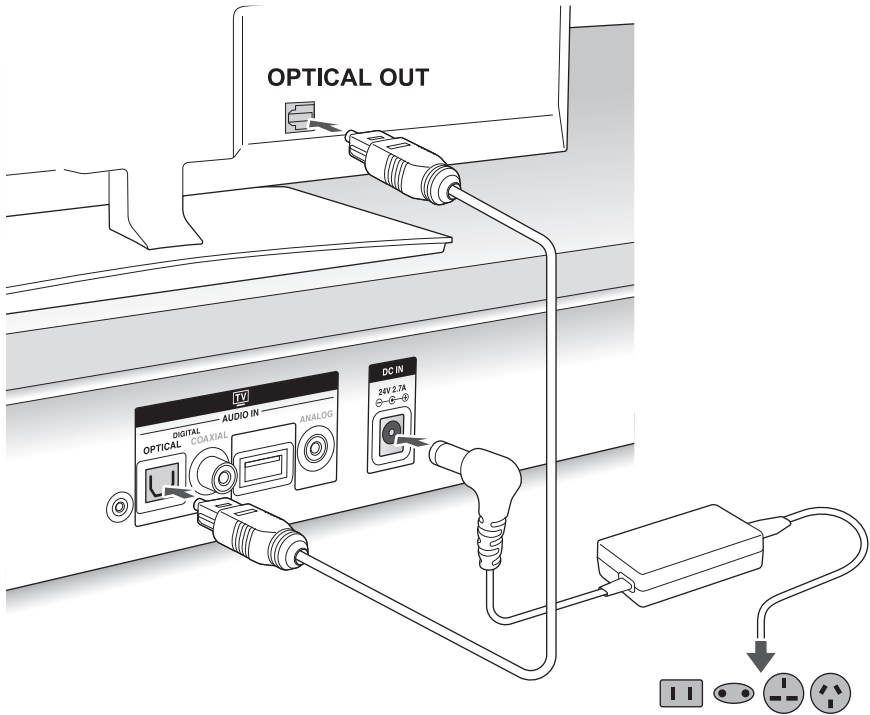

If there is the OPTICAL jack on the TV being used (illustrated above)

Make a digital connection to the TV with the supplied optical digital audio cable. Connect the AC adapter/power cord into the DC IN on the unit, and then connect the other end of the power cord into an electrical outlet.

Important :

Depending on the TV to be used with this unit, the sound coming through the TV's built-in speakers can be out of sync with the sound coming through the unit. Be sure to turn off the built-in speaker output on your TV before using the unit. Perform the same procedure when also making connections using the stereo mini plug cable or coaxial cable.

If there is no OPTICAL jack on the TV being used

Connect either of the following.

- Make an analogue connection with the TV using the supplied stereo mini plug cable.



- Make a digital connection to the TV using a coaxial cable (sold separately).

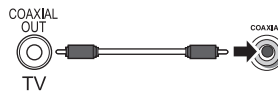



Listening to TV



Basic operations

1. Turn on the TV.

Auto Power On is turned on by default, and so power to the unit turns on automatically. The input source automatically switches to TV, and audio from the TV is played.

- The input source switches to TV, and the input source indicator lights in white.

To cancel Auto Power On: press and hold  on the unit, and then press and hold  while continuing to press . The input source indicator flashes twice (white) to indicate that this setting is now off.

- Repeating this procedure switches between on/off. The indicator flashes once to indicate that this setting is now on.
- When this setting is off, press  to turn on the power to the unit, and then press  to switch the input source to TV.

To adjust the volume of this unit

Allows to adjust the volume by 1 step in the 0 to 35 range.

1. Press VOLUME +/-.

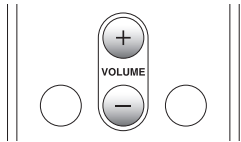

The status indicators (white) indicate the volume level.

- ○ ○ ● ● Volume: "Middle"

To adjust the subwoofer level

Allows to adjust the subwoofer level by 1 step in the -10 to +10 range while listening to the sound. The default setting is 0. Also, the subwoofer level is set to individual levels for each different SOUND MODE.

1. Press SUBWOOFER +/-.

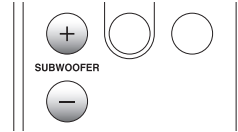

The status indicators (white) indicate the subwoofer level.



- ● ○ ● ● Volume: "Standard"

To mute the sound

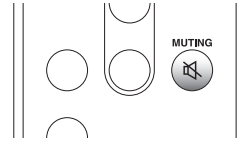
1. Press MUTING.



The status indicator flashes when the audio is muted. Press again to cancel muting. Muting will also be canceled when the volume is changed or the power is turned off and on.

- When using buttons on the unit, press  and  at the same time. Press again to cancel muting.

Change the desired sound quality (SOUND MODE)

You can switch the sound mode of input sound as desired.

1. Press SOUND MODE button.

The sound modes are switched in the following order each time this button is pressed. The status indicator lights (orange) indicate the current mode.

 (Standard)

Play files with a good balance from low through to high frequencies. This is the standard mode with neutral settings.

 (Surround)

Creates a richer sound field, provides realistic sound movement and amplifies bass sounds. Ideal for watching movies.

 (Stereo)

Suitable for listening to music. Playback music with pure quality similar to the original sound.

 (Voice)

Play files with voice clearly. Ideal when watching the news or documentary programmes.

Switch audio in sound-multiplex programmes

This can be set only when the audio signal is Dolby Digital. Press and hold the SOUND MODE button on the remote controller for approximately 3 seconds. Pressing and holding switches the source in the following order.

Main: The input indicator (white) flashes once.



Secondary: The input indicator (white) flashes twice.

Main+Secondary: The input indicator (white) flashes three times.

Auto Standby function:

If there is no audio input and no operation of the unit has been performed for some time, the power will automatically enter standby mode as Auto Standby is on by default. The time taken to enter standby mode depends on the connected cables or the input source.

- Connecting with the optical digital audio cable or coaxial cable: 2 hours (5 minutes when power to the TV is off)
- Connecting with the stereo mini plug cable: 5 minutes
- Bluetooth/USB (North American models): 5 minutes

To cancel this function, press and hold  on the unit, and then press and hold  while continuing to press . The input source indicator flashes twice (white) to indicate that this setting is now off.

- Repeating this procedure switches between on/off. The indicator flashes once to indicate that this setting is now on.

Using a TV Remote Controller

Preprogrammed feature

The unit has been preprogrammed so that the unit can be operated using your TV remote controller. Volume control and muting(*) operations can be performed with this feature. If you want to use other functions or cannot operate the unit with your TV remote controller, you can use the learning function (described below) to enable these features.

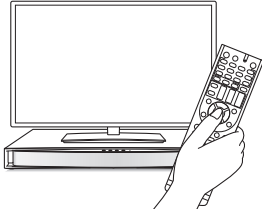

To cancel this feature, press and hold \ominus for approximately 3 seconds while continuing to press and hold \oplus on this unit. The input source indicator will flash (white) for 10 seconds. Do not operate the unit during this time. Afterwards, it will flash 3 times to indicate that this feature has been cancelled. Perform the same procedures to use the TV remote controller again.

* The mute state can be turned over each time you press the Mute button on your TV remote controller. In such case, you can synchronize the mute status of the unit and the TV by pressing and holding the Mute button on your TV remote controller.

Learning function

The unit is set so that signals emitted from each button on your TV remote controller control specific operations.

* It is recommended to select buttons that do not prevent TV operation when assigning the functions to your remote controller. Signal of some types of remote controller may not be received by the unit.

E.g.) To assign the unit's ON/STANDBY function to the TV remote controller:

1. Press the \oplus button on the unit for approximately 3 seconds while pressing and holding the \ominus button. The input source indicator (white) flashes for 10 seconds.

2. While the input source indicator is flashing, press any button on the TV remote controller 3 times while aiming it at the remote control signal sensor of the unit.

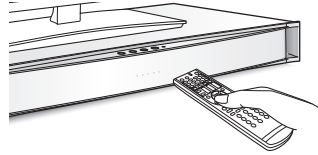

The indicator flashes twice (white) to indicate that this was successfully configured. After this is set, pressing the button on the TV remote controller will enable ON/STANDBY operation on the unit.

The learning function enables the following unit functions to be operated with your TV remote controller. Press and hold the following buttons instead of \oplus in step 1.

- VOLUME +: \oplus
- VOLUME -: \ominus
- MUTING: \oplus and \ominus
- INPUT: \oplus and \oplus
- SOUND MODE: \oplus and \ominus

To prevent incorrect operation:

The unit is preprogrammed to support a large number of TV remote controllers. For this reason, using remote controllers other than that supplied with the unit and TV remote controllers may result in unexpected operation. To prevent incorrect operation, press and hold \oplus on the unit, and then press and hold \ominus while continuing to press \oplus for 3 seconds. The input source indicator will flash (white) for 10 seconds. During this time, aim the TV remote controller toward the unit and press either the volume button or mute button once. The input source indicator will flash twice (white), which indicates that the unit will not accept signals emitted when buttons are pressed on remote controllers other than the supplied remote controller or the TV remote controller.

- Controlling function may not be set to some TV remote controller.

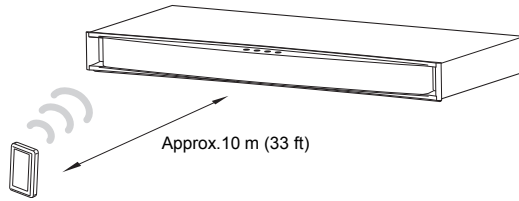

Playing via Bluetooth Connection



You can wirelessly enjoy music files stored in a smartphone or other Bluetooth-enabled device. The coverage area is 10 meters (33 feet).

Pairing

Pairing is necessary when using the Bluetooth-enabled device for the first time. Before starting the procedure, learn how to enable the Bluetooth setting function and to connect with other devices on the Bluetooth-enabled device.

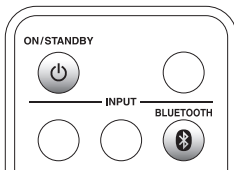

1. Press  to turn on the unit.
2. Press  to switch the selector to Bluetooth.





The unit begins pairing, and the input source indicator on the unit will flash quickly (blue). The pairing mode will be cancelled after 30 seconds. During this time, perform the following operation. The indicators will flash slowly indicating that this has been cancelled.

3. Select the unit (Onkyo LS-T30) after it displays on the screen on the Bluetooth device. After a short time, the input source indicator will light (blue), and the devices are now paired.
 - If a passcode (password, passkey or PIN code) is requested, enter "0000".
 - Devices should be in close proximity when pairing.

Playing sound of the Bluetooth-enabled device

1. Press  to turn on the unit.
2. Press  to switch the selector to Bluetooth. The input source switches to Bluetooth, and the input source indicator lights in blue.
3. Play music files by after connecting the Bluetooth device.
 - If the volume setting on the Bluetooth-enabled device is low, the sound will not be output from this unit.
 - Due to the characteristics of Bluetooth wireless technology, the sound produced on this unit may slightly be behind the sound played on the Bluetooth-enabled device.

To register other Bluetooth devices: Turn on the power to the unit, switch the input to Bluetooth, and then press and hold  to start pairing on the unit. Next, select the unit (Onkyo LS-T30) on some other Bluetooth device to make a connection.

- Up to 16 Bluetooth devices can be saved with the unit.
- When using buttons on the unit, press and hold .





Troubleshooting

Before starting the procedure

Problems may be solved by simply turning the power on/off or disconnecting/connecting the power cord, which is easier than working on the connection, setting and operating procedure. Try the simple measures on both the unit and the connected device.

■ Resetting the unit

Resetting the unit to the status at the time of shipment may solve the problem. Reset the unit with the following procedure.

Press and hold the  button on the unit when the power is on, and then press and hold   while continuing to press  for 10 seconds. When reset is complete, the INPUT source indicator and all status indicators light and the unit automatically enters the standby mode.

Can't turn on the unit

- Make sure that the power cord is properly plugged into the wall outlet.
- Unplug the power cord from the wall outlet, wait 10 seconds or more, then plug it in again.

The unit turns off unexpectedly

- The unit will automatically enter standby mode when Auto Standby launches.

The sound stops suddenly, or stops during playback

- The protective circuits of the unit may be operating. Unplug the power cord from the wall outlet immediately. Check that all cables are connected and that the input source is correct, and leave the power cord unplugged for 5 minutes. Plug the power cord in again and turn the unit power on. If the sound still cuts out, unplug the power cord and contact your Onkyo dealer.
- If smoke, smell or abnormal noise is produced by the unit, unplug the power cord from the wall outlet immediately and contact your Onkyo dealer.

There's no sound, or it's too small

- Make sure that all audio connecting plugs are pushed in all the way.
- Make sure that the input of device is connected properly.
- When the status indicator flashes in white, the muting is enabled. Press MUTING button on the remote controller or the VOLUME +/- buttons on the remote controller or the unit to disable the muting.
- Make sure that none of the connecting cables are bent, twisted, or damaged.
- Audio is output through only one type of connection. When multiple terminals are in use, the priority of audio output is given in the order of the OPTICAL terminal, COAXIAL terminal, and ANALOG terminal.

Noise can be heard

- Do not bind the power cord, connection cables and other audio cables with a band.
- An audio cable may be picking up interference. Try repositioning your cables.

The remote controller doesn't work

- Make sure that the battery is installed with the correct polarity.
- Make sure that the remote controller is not too far away from the unit, and that there's no obstruction between the remote controller and the unit's remote control sensor.
- Make sure that the unit is not subjected to direct sunshine or inverter type fluorescent lights. Relocate if necessary.
- If the remote controller does not work the first time after purchase or if it has not been used for a long period of time, the battery may have become flat and the remote controller will not operate. Try the following methods.
 - Press and hold the VOLUME - button on the remote controller for some time (10 seconds or more). (try this several times)
 - Remove the button cell, wipe it with a clean cloth and insert it again.

Specifications

Rated Output Power (FTC):

Front speaker:

(North American) 12.5 W minimum continuous power per channel, 4 ohm loads, 2 channel driven at 1 kHz, with a maximum total harmonic distortion of 1%

Subwoofer:

(North American) 25 W minimum continuous power, 4 ohm loads, 1 channel driven at 80 Hz, with a maximum total harmonic distortion of 1%

Rated Output Power (IEC):

Front speaker:

(Others) 2ch × 12.5 W at 4 ohms, 1 kHz 1ch driven of 1%

Subwoofer:

(Others) 1ch × 25 W at 4 ohms, 80 Hz 1ch driven of 1%

Frequency response: 20 Hz - 20 kHz

Power Supply: AC100 - 240 V, 50/60 Hz

Power Consumption: 17 W

Stand-by Power Consumption:

(North American) 0.40 W

(Others) 0.45 W

Dimensions (W×H×D):

905 mm×95 mm×400 mm

(35-5/8"×3-3/4"×15-3/4")

Weight:

10.4 kg (22.9 lbs.)

Audio inputs

Digital input: OPTICAL: 1

COAXIAL: 1

(North American) USB: 1

Analog Stereo Input: Ø 3.5 mm mini

Bluetooth: Version: 2.1+EDR

Profile: A2DP GAVDP

Speaker unit (None magnetic shielding)

Front speaker: 6.5 cm (2-1/2") Cone × 4

Subwoofer: 16 cm (6-1/2") Cone × 1

- Design and specifications are subject to change without notice.

Playing USB Memory (North American models)

- The unit supports USB memory formatted using FAT12, FAT16 and FAT32 file system.
- The unit is compatible with WAV playback and following audio format is supported.
Format: Microsoft PCM format
Number of channels: 1 or 2 channels
Sampling frequency: 32 to 48 kHz
Quantization bit width: 8 or 16 bit depth
RIFF chunk: format chunk (without extended), data chunk
- You can play WAV files stored on the root folder only. WAV files stored on the other folders cannot be played on this unit.
- The unit supports USB flash drives only. Note, however, that playback may not be possible with some USB flash drives.

Disclaimer

- The unit contains a microcomputer for signal processing and control functions. In very rare situations, severe interference, noise from an external source, or static electricity may cause it to lock up. In the unlikely event that this happens, unplug the power cord from the wall outlet, wait at least five minutes, and then plug it back in. If it doesn't work properly, please try resetting.

■ Trademarks and Licensing



Manufactured under license from Dolby Laboratories. Dolby and the double-D symbol are trademarks of Dolby Laboratories.



For DTS patents, see <http://patents.dts.com>.
Manufactured under license from DTS Licensing Limited. DTS, the Symbol, & DTS and the Symbol together are registered trademarks, and DTS Studio Sound is a trademark of DTS, Inc. (C)DTS, Inc. All Rights Reserved.



The Bluetooth® word mark and logos are registered trademarks owned by Bluetooth SIG, Inc. and any use of such marks by Onkyo is under license. Other trademarks and trade names are those of their respective owners.

Supplied Accessories

Make sure you have the following items before use.

- The number in parenthesis indicates the quantity.
- In catalogs and on packaging, the letter at the end of the product name indicates the color.



AC adapter (1)
Power cord (1)

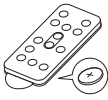

Remote controller (1)
RC-894S (North American models)
RC-895S (Others)



Optical digital audio cable 1.5 m (5 ft.) (1)



Ø 3.5 mm stereo mini plug cable (1)



Cushion (8)
(attach to the bottom face of the TV)



Vibration prevention cushions (4)

ONKYO

Onkyo Corporation

Kitahama Chuo Bldg, 2-2-22 Kitahama, Chuo-ku, OSAKA 541-0041, JAPAN
<http://www.onkyo.com/>

The Americas

Onkyo U.S.A. Corporation

18 Park Way, Upper Saddle River, N.J. 07458, U.S.A.
For Dealer, Service, Order and all other Business Inquiries:
Tel: 201-785-2600 Fax: 201-785-2650
<http://www.us.onkyo.com/>

For Product Support Team Only:
1-800-229-1687
<http://www.us.onkyo.com/>

Europe

Onkyo Europe Electronics GmbH

Liegnitzerstrasse 6, 82194 Groebenzell, GERMANY
Tel: +49-8142-4401-0 Fax: +49-8142-4208-213
<http://www.eu.onkyo.com/>

Onkyo Europe Electronics GmbH (UK Branch)

Meridien House, Ground floor, 69 - 71 Clarendon Road, Watford, Hertfordshire, WD17 1DS, United Kingdom
Tel: +44 (0)8712-00-19-96 Fax: +44 (0)8712-00-19-95

China

Onkyo China Limited (Hong Kong)

Unit 1033, 10/F, Star House, No 3, Salisbury Road, Tsim Sha Tsui Kowloon, Hong Kong.
Tel: 852-2429-3118 Fax: 852-2428-9039
<http://www.hk.onkyo.com/>

Onkyo China PRC (Mainland)

1301, 555 Tower, No.555 West NanJing Road, Jing'an District, Shanghai, China 200041,
Tel: 86-21-52131366 Fax: 86-21-52130396
<http://www.cn.onkyo.com/>

Asia, Oceania, Middle East, Africa

Please contact an Onkyo distributor referring to Onkyo SUPPORT site.
<http://www.intl.onkyo.com/support/>

The above-mentioned information is subject to change without prior notice.
Visit the Onkyo web site for the latest update.

SN29401856

(C) Copyright 2014 Onkyo Corporation Japan. All rights reserved.



* 2 9 4 0 1 8 5 6 *

F1408-0