













CRANE PLUS

U s e r G u i d e

Contents

■ Packing List	1
■ Disclaimer and Warning	2
■ Quick Start Guide	7
■ Preparing and Charging the Batteries	8
■ Camera Installation	9
■ Balance Adjustment	11
■ Start Up	14
■ Introducing Gimbal Control Modes	16
■ Initialization and Various Operations	18
■ APP Operations	20
■ Usage of Main Accessories	22
■ Product Specifications	28
■ Operation guide on motor torque adjustment	29
■ Warranty Card	30
■ Contact Card	32

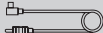
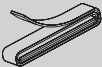
The product package comes with the following items. In case that any item is found missing, please contact ZHIYUN or your local selling agent.

	CRANE PLUS 3-Axis Gimbal Stabilizer	1		Battery Compartment	1
	Lens Mounting Clamp	1		Mounting Screw	2
	26500 Battery Charger	1		26500 Li-ion Battery	2
	Micro USB Cable	1		Tripod	1
	Panasonic Camera Control Cable	1		Anti-slip grip tape	1
	Sony Camera Control Cable	1			

Thank you for using ZHIYUN CRANE PLUS . The information contains herein affects your safety and your legal rights and responsibilities. Read this entire document carefully to ensure proper configuration before use. Failure to read and follow the instructions and warnings herein may result in serious injury to you or bystanders, or damage to your device or property.

ZHIYUN reserves the right of final explanation for this document and all relevant documents relating to CRANE PLUS, and the right to make changes at any time without notice. Please visit www.zhiyun-tech.com for the latest product information.

By using this product, you hereby signify that you have read this document carefully and that you understand and agree to abide by the terms and conditions herein. You agree that you are solely responsible for your own conduct while using this product, and for any consequences thereof. You agree to use this product only for purposes that are proper and in accordance with all terms, precautions, practices, policies and guidelines ZHIYUN has made and may make available.

ZHIYUN™ accepts no liability for damage, injury or any legal responsibility incurred directly or indirectly from the use of this product. Users shall observe safe and lawful practices including, but not limited to, those set forth herein.

ZHIYUN™ is the trademark of Guilin Zhishen Information Technology Co., Ltd. (hereinafter referred to as "ZHIYUN" or "ZHIYUN TECH") and its affiliates. All product names or marks referred to hereunder are trademarks or registered trademarks of their respective holders.

Glossary

The following terms are used throughout the product literature to indicate various levels of potential harm when operating this product.

WARNING: Procedures, which if not properly followed, may incur property damage, grave accident, or serious injury.

CAUTION: Procedures, which if not properly followed, may incur property damage and serious injury.

NOTICE: Procedures, which if not properly followed, may incur property damage or minor injury.

Warning

Read the ENTIRE User Guide to become familiar with the features of this product before operating. Failure to operate the product correctly can result in damage to the product or personal property and cause serious injury. This is a sophisticated product. It must be operated with caution and common sense and requires some basic mechanical ability. Failure to operate this product in a safe and responsible manner could result in injury or damage to the product or other property. This product is not intended for use by children without direct adult supervision. DO NOT use with incompatible components or in any way otherwise as mentioned or instructed in the product documents provided by ZHIYUN. The safety guidelines herein contain instructions for safety, operation and maintenance. It is essential to read and follow all of the instructions and warnings in the User Guide, prior to assembly, setup or use, in order to operate the product correctly and avoid damage or serious injury.

Safe Operation Guidelines

■ CAUTION:

1. CRANE PLUS is a high-precision control device. Damage may be caused to CRANE PLUS if it is dropped or subject to external force, and this may result in malfunction.
2. Make sure the rotation of the gimbal axes is not blocked by external force when CRANE PLUS is turned on.
3. CRANE PLUS is not waterproof. Prevent contacts of any kind of liquid or cleaner with CRANE PLUS. It is recommended to use dry cloth for cleaning.
4. Protect CRANE PLUS from dust and sand during use.

■ NOTICE:

Keep the handle stable when CRANE PLUS is powered on, as shaking may cause failure to start up.

Reading Tips

Legends:  Hints and tips

 Important.

Battery Safety Guidelines

1. Prevent the batteries to come into contact with any kind of liquid. Do not leave batteries out in the rain or near a source of moisture. Do not drop the battery into water. If the inside of the battery comes into contact with water, chemical decomposition may occur, potentially resulting in the battery catching on fire, and may even lead to an explosion.
2. If the battery falls into water with the stabilizer during use, take it out immediately and put it in a safe and open area. Maintain a safe distance from the battery until it is completely dry. Never use the battery again, and dispose of the battery properly as described in the Battery Disposal section below.
3. If the battery catches fire, use water, water spray, sand, fire blanket, dry powder, or carbon dioxide fire extinguisher immediately to put out the fire. Please extintc the fire by applying the methods recommended above according to the actual situation.
4. Never use non-ZHIYUN batteries. If replacement or backup is needed, please purchase new batteries from ZHIYUN's official website or authorized channels. ZHIYUN takes no responsibility for any damage caused by non-ZHIYUN batteries.
5. Never use or charge swollen, leaky, or damaged batteries. Never use or charge if the battery smells, or overheats (exceeding maximum temperature of 160°F / 71°C). If your batteries are abnormal, contact ZHIYUN or a ZHIYUN authorized dealer for further assistance.
6. The battery should be used within the temperature range from -10°C to 50°C. Use the battery in environments above 50°C can lead to a fire or explosion. Use of battery below -10°C can lead to serious battery damage.
7. Do not use the battery in strong electrostatic or electromagnetic environments. Otherwise, the battery protection board may malfunction.
8. Do not disassemble or use any sharp object to puncture the battery in any way. Otherwise, the battery may leak, catch fire or explode.
9. Do not mechanically strike, crush, or throw the battery. Do not place heavy objects on the battery or charger.
10. Electrolytes inside the battery are highly corrosive. In case of accidental contact of any electrolytes with your skin or eyes, rinse immediately with water for at least 15 minutes and seek medical advice as soon as possible.
11. Do not use the battery if it has been involved in a crash or heavy impact.
12. Do not heat the battery and never put the battery in a microwave oven or in a pressurized container.
13. Do not place the battery cell on a conductive surface (such as a metal desk surface).
14. Prevent use of wires or other metal objects that could cause positive and negative short-circuit to the battery.
15. If the battery terminal is dirty, wipe it with a clean, dry cloth. Otherwise it will cause a bad battery connection, which may result in energy loss or charging failure.

Battery Charging

1. Do not attach the batteries to a wall outlet or car charger socket directly. Always use a ZHIYUN approved adapter for charging. ZHIYUN takes no responsibility if the battery is charged using a non-ZHIYUN charger.
2. Do not put the battery and charger near flammable materials or on flammable surfaces (such as carpet or wood). Never leave the battery unattended during charging to prevent any accident.
3. Do not charge the battery immediately after use, because the battery temperature may be too high. Do not charge the battery until it cools down to normal room temperature. Charging the battery with its temperature over 40°C or lower than 15°C may lead to leakage, overheating, or damage.
4. Examine the charger before use, make sure there is no damage to the enclosure, cord, plug, or other parts. Never use a damaged charger. Do not clean the charger with any liquid containing alcohol or other flammable solvents. Disconnect the charger when not in use.

Battery Storage

1. Keep batteries out of the reach of children and pets.
2. Do not leave the battery near heat sources such as a furnace or heater, or inside of a vehicle on hot days. Never expose the battery in any environment with temperature of over 60°C. The ideal storage temperature is 22°C-28°C.
3. Store batteries in a dry environment.
4. Do not leave the battery unused for too long after it has been completely discharged to prevent over-discharge of battery which may result in battery damage and permanent failure.

Battery Maintenance

1. Never use the battery when the temperature is too high or too low.
2. Do not store the battery in any environment with a temperature of over 60°C.

Transportation Notice

1. Discharge the battery power to 5% or lower before carrying the battery on an airline flight. Only discharge the battery in a fireproof location, ideally in a dry and open area.
2. Do not store or transport batteries together with metal objects such as eyeglasses, watch, and jewelries, etc.
3. Do not transport damaged batteries. When transporting, be sure to discharge the battery to less than 50%.

Battery Disposal

Dispose of the battery in specific recycling boxes only after a complete discharge. Do not put away the battery in regular trash containers. Strictly follow your local regulations regarding the disposal and recycling of batteries.

NOTICE**Battery Use**

Make sure the batteries are fully charged before each time of use.

Battery Charging

The battery will stop charging automatically when it is full. Disconnect the batteries from the charger when fully charged.

Battery Storage

1. Discharge the battery to 40%-65% if it will NOT be used for over 10 days. This can greatly extend the battery life.
2. The battery enters hibernation mode when voltage gets too low. Charge the battery will bring it out of hibernation.
3. Remove batteries from the stabilizer when not in use and store them in a specialized container.

Battery Disposal

If the battery cannot be fully discharged, do not leave it in the recycling box, but contact a professional battery disposal/recycling agent for further assistance.

Get to Know CRANE PLUS

Check the product package before use, make sure that all items below have arrived with the product. In case that any item is found missing, please contact ZHIYUN or your local selling agent.

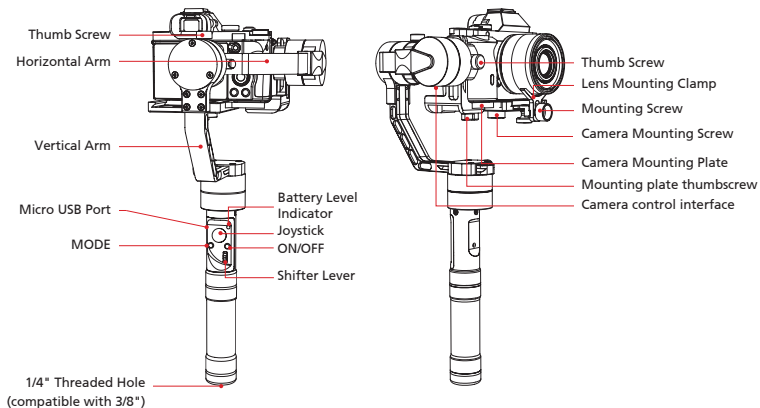

NOTICE: Camera is not included in product package, and shall be bought separately. The depictions provided herein are for reference only.

Before using CRANE PLUS for the first time, please fully charge the batteries to activate and ensure normal operation by using the charger that comes in the package.

Name: 26500 Li-ion battery charger
 Model: ZC-26500
 Input voltage: DC 5V 2400mA
 Output voltage: DC 4.2V 1200mA*2

- Shines solid RED light when charging
- Shines BLUE light when fully charged

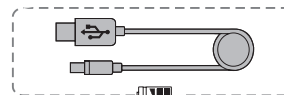
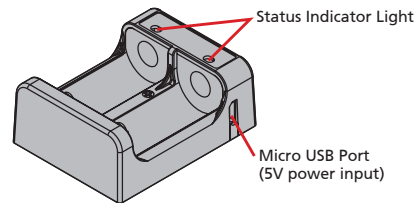

Micro USB Cable
 26500 Li-ion Battery
 Capacity: 3600mAh
 Voltage: 3.7V

■ **NOTICE**

1. The charger is for charging ZHIYUN's IMR 26500 Li-ion Battery only. Do not charge batteries of other models or brands, otherwise it may lead to accident.
2. Use qualified 5V adapter with output current of $\geq 1000\text{mA}$ only. Charging time depends on the max. output current of the adapter.

Please use and charge batteries provided or approved by ZHIYUN only. ZHIYUN will not take any responsibility for explosion, fire and/or accidents caused by non-ZHIYUN batteries.

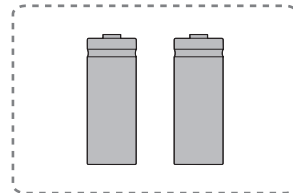

Operation Method

Top Down Mode

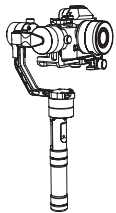

Bottom Up Mode

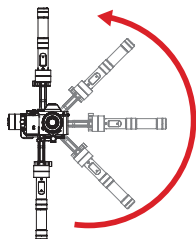

Gimbal balance shall be properly adjusted before accessing Bottom Up mode. Do not rotate the handle while turning it straight up/down to switch between Top Down and Bottom Up mode.

Note: The size of the camera and its balance condition when mounted may affect the successful access to Bottom Up mode. For certain camera models, balance should be adjusted after access to Bottom Up mode.

⚠ When the motor arm is pulled to an extreme extent in case of big lens mounting, Bottom Up Holding Gesture may not be supported.

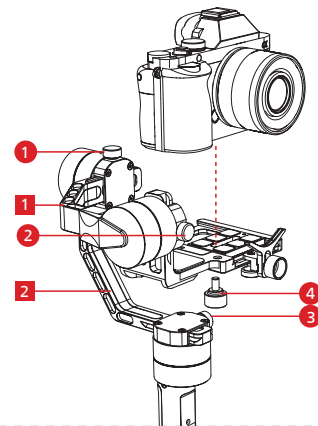

Mount the camera in parallel with the mounting plate, match the 1/4" Threaded Hole at the bottom of the camera with the empty slot of the mounting plate. Move the camera as close as possible to the Tilt Motor, and tighten the Camera Mounting Screw ④ to fix the camera position Tilt Motor, and tighten the Camera Mounting Screw ④ to fix the camera position.

⚠ Do not power on the stabilizer before the camera is properly mounted.

Level Adjustment on Tilt Axis

Mounting Plate

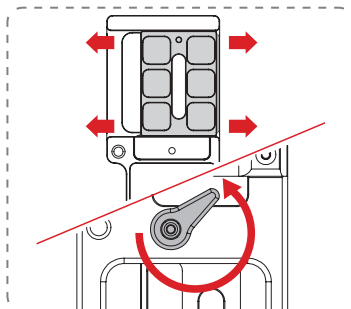

Loosen the thumbscrew at the bottom of the quick mounting plate to allow forward and backward sliding of the plate.

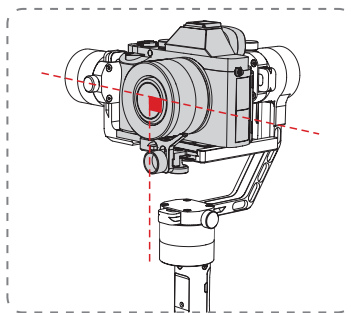

Push the camera forward or backward to find its level balance. Once the camera can stay still and almost level with its lens facing front, complete this step by tightening up the Camera Mounting Screw.

Firstly, loosen Thumb Screw **2** (rotate for 3 times).

Adjust the Tilt Axis until the camera can stay still with the lens facing up (i.e. the camera stays still and vertical to the ground), complete this step by tightening up Thumb Screw **2**.

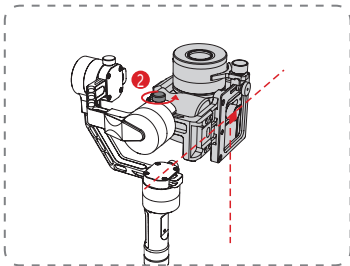

Balance Adjustment on Roll Axis

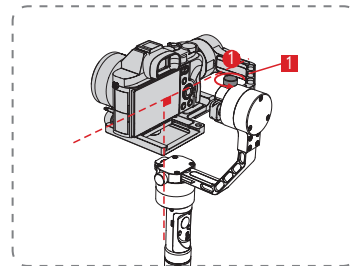

Loosen Thumb Screw **1**. Adjust the Roll Axis until the camera can stay still while keeping the Horizontal Arm **1** level. Complete this step by tightening up Thumb Screw **1**.

Level Adjustment on Pan Axis

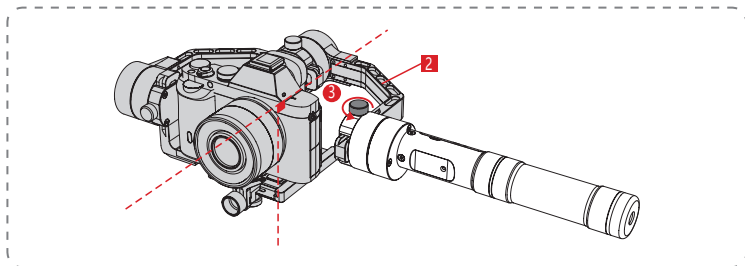

Loosen Thumb Screw ③. Adjust the Pan Axis until the camera can stay still while keeping the Vertical Arm ② level when turned to the right/left side. Complete balance adjustment by tightening up Thumb Screw ③.

Control Panel Introduction

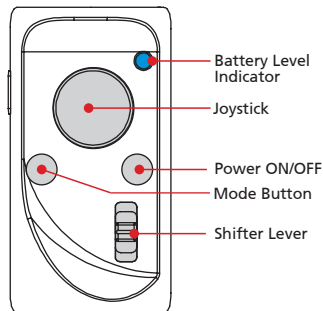
**Shifter Lever Operation**

In the event when a SONY camera is connected: Push the Shifter Lever in T direction to zoom out, and in W direction to zoom in.

In the event when a Panasonic camera is connected: Move the Shifter Lever to either direction for focusing.

Micro USB Port

Connects the stabilizer to a computer through a Micro USB cable for on-line

Mode Button

Press for 1 second to enter or exit standby mode. Single press to switch between pan-following and lock mode.

Quick double press to enter the following mode. Quick triple press to enter the selfie mode (180° rotation on pan axis)

Power ON/OFF

Power on the stabilizer by pressing the Power button for about 3 sec.

After the stabilizer is powered on, the Power button can be used for camera shooting control (only after the camera is connected to the stabilizer).

Single press the button to take photos.

Double press the button to start video recording.

Double press the button again to stop recording.

Joystick Operation

Joystick controls the camera movement by turning the 3 axes up/down or left/right.

Battery Level Indicator

Shines YELLOW light when the stabilizer is Powered on/off:

Quick flash for 3 sec. and shines solid for 1 sec. when powered on. Quick flash for 3 sec. when powered off.

Shines BLUE light when the stabilizer is in normal operation, the flashing frequency of the BLUE light indicates the current battery level:

Quick flash 4 times for battery level of 75%-100%.

Quick flash 3 times for battery level of 50%-75%.

Quick flash 2 times for battery level of 25%-50%.

Quick flash 1 time for battery level of 0%-25%.

How to Start Up

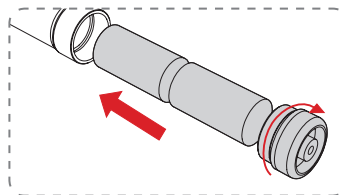

1. Rotate to loosen the end cover, then install two 26500 Li-ion batteries. Make sure to tighten the end cover properly after battery installation, or the stabilizer cannot be turned on.

Batteries shall be installed with the positive pole heading the arrow direction as shown in the figure.

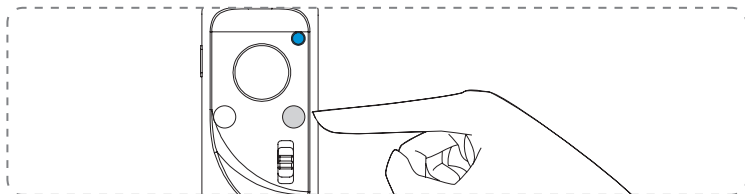

2. After the batteries are installed properly, long press the power button for 3 sec. to power on.

⚠ Please use batteries provided or approved by ZHIYUN only, otherwise it may cause accidents. When using the stabilizer, please hold the camera with one hand to prevent severe shaking of the camera in case a malfunction occurs to the stabilizer (in very rare cases).

V1.70 Gimbal Control Modes

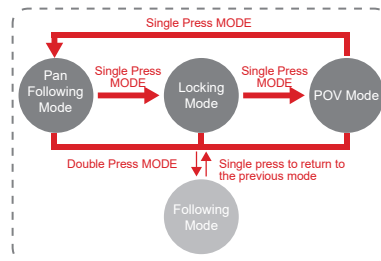

Mode Switch Schematic Figure

Mode switch:

1. Single press MODE button allows switching of the 3 modes-Pan following mode, Locking mode and POV mode - in cyclic sequence. The default mode when powered on is Pan following mode.
2. Double press MODE button under any of the 3 modes above will switch into Full following mode. Single press MODE button in this mode will return to the previous mode.
3. Quick press MODE three times and the camera will turn 180° along the pan axis while the active control mode remains unchanged.

V1.71 Gimbal Control Modes

- Single Press of Mode Button



Switch between Pan Following Mode and Locking Mode.

- Double Press of Mode Button



Switch between Following Mode and POV Mode.

- Triple Press of Mode Button

The pan axis rotates 180° without changing the current mode (not available in Locking mode)

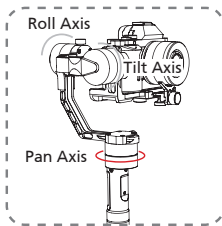
**Pan Following Mode:**

The camera pans left/right following the movement of the stabilizer while the tilt and roll axes are locked. Push the joystick up/down allows manual control of the tilt axis.

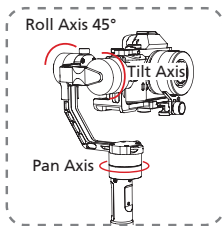
**POV Mode:**

This mode allows the camera to roll left/right at max. angle of 45°, and pan left/right or tilt up/down with unlimited 360° rotation following the movement of the gimbal handle.

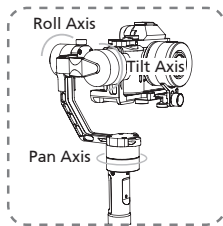
**Locking Mode :**

This mode locks movement of all three axes to keep the camera fixed on a shooting direction. Push the joystick up/down and left/right allows manual control of the tilt axis and pan axis.

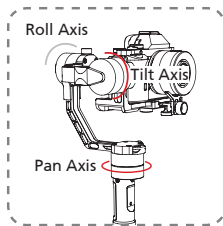
**Following Mode :**

The camera pans and tilts following the movement of the stabilizer. Push the joystick left/right allows manual control of the roll axis.

Initializing the Stabilizer

Initialize the stabilizer under the following circumstances:

1. Slight deviation is found in the tilt angle of the camera in level position after startup.
2. Slight deviation is found in the roll angle of the camera in level position after startup.
3. Frequent small angle correction is found when the camera is in level position while the stabilizer stays still.

Initialization Procedure

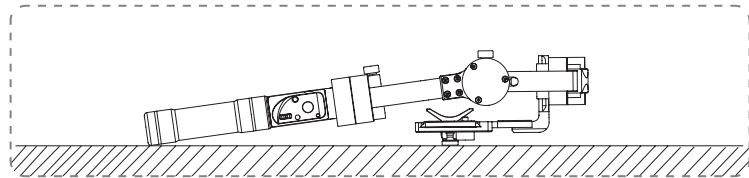

1. Install the batteries properly.
2. Hold the camera mounting plate and long press the Power Button to turn on the stabilizer. The motor will generate acting force upon activation, hold the camera mounting plate still, and long press the Mode Button to enter standby mode.
3. Put the stabilizer still on a table surface, wait for about 10 sec., and the stabilizer will automatically complete initialization.

⚠ If slight deviation can still be found after initialization, repeat the procedure above to initialize again.

Firmware Upgrade

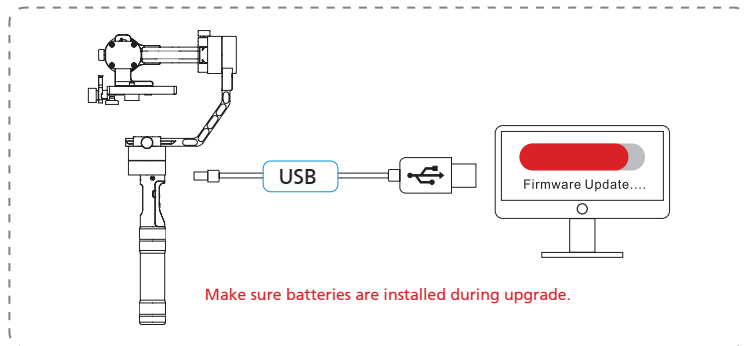

1. Visit ZHIYUN's official website: www.zhiyun-tech.com.
2. Click to open the "Downloads" page, and find the Firmware Upgrade Tutorial package.
3. Download the driver, calibration tool and latest firmware corresponding to your stabilizer.
4. Upgrade firmware following the instructions indicated in the Firmware Upgrade Tutorial.

APP Download and Installation



Download the APP from the "Downloads" page on ZHIYUN's official website www.zhiyun-tech.com, or by directly scanning the QR code on the left (Android 5.0 above or iOS 9.0 above required) to download. Users can download the APP by searching "ZY Play" in Google Play or APP Store.

The ZHIYUN APP is subject to regular update, try out now to discover more functions.

Connecting the Stabilizer to Smartphone

1. Search "ZY Play" on App store/Google Play store and download.
2. Turn on the stabilizer.
3. Open "ZY Play", tap "Connect Device" and select your stabilizer.



Main Features of the APP



Monitoring screen:
Allows checking of the stabilizer's working status.

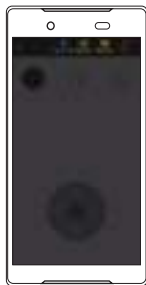

Calibration screen:
Calibration is required when deviations are found in the 3 axes and the leveling of the camera. Tap "Start Calibration", and complete the 6-side calibration procedure following the onscreen illustrations.



Control screen:
Allows various controls to the stabilizer, including change of Gimbal Control Mode and corresponding axis movement control.



Gimbal setting screen:
Allows adjustment of various parameter settings of the stabilizer (Refer to APP instructions for specific operations).

Panasonic Camera Control Line

Applicable camera models :

GH3/GH4/GH5

Compatible Stabilizer Model(s):

CRANE / CRANE PLUS with firmware version of V1.50 and above.

Supported Functions:

1. Shutter control
2. Video recording

How to Use**Connection**

1. Firstly, connect the stabilizer to your PC or smart phone.
2. Configure the stabilizer to suits "Panasonic" in Gimbal Setting Screen, then save the settings.
3. Connect the Micro USB plug of the Panasonic camera control line to the camera connection port on the side of the tilt motor, and then connect the other end of the control line to the REMOTE port on the camera.
4. Power on the stabilizer before turning on the camera, otherwise camera remote control may not work.

Operations

1. Shutter control (including focusing): Press the Power Button to take single shots.
2. Video recording: Double press the Power Button to start video recording, and double press again to stop recording.

Sony Camera Control Line

Applicable camera models :

Compatible with SONY cameras controlled by MULTI port.

Compatible Stabilizer Model(s):

CRANE / CRANE-M / CRANE PLUS with firmware version of V1.50 and above.

Supported Functions:

- 1.Shutter control
- 2.Video recording
- 3.Zooming

NOTICE: Optical zooming is not supported in case of non-electrical lenses (Recommended electrical zoom lenses: E PZ 18-105mm F4 GOSS, E PZ 16-50mm F3.5-5.6 OSS).

How to Use**Connection**

1. Firstly, connect the stabilizer to your PC or smart phone.
2. Configure the stabilizer to suits "Sony" in Gimbal Setting Screen, then save the settings.
3. Connect the Micro USB plug of the SONY camera control line to the camera connection port on the side of the tilt motor, and then connect the other end of the control line to the MULTI port on the camera.
4. Power on the stabilizer before turning on the camera, otherwise camera remote control may not work

Operations

1. Shutter control (including focusing): Press the Power Button to take single shots.
2. Video recording: Double press the Power Button to start video recording, and double press again to stop recording.
3. Zooming: Push the Shifter Lever on the stabilizer handle in T direction to zoom out or W direction to zoom in.

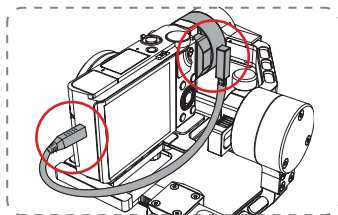

ZW-B02 Wireless Remote Control(purchase separately)

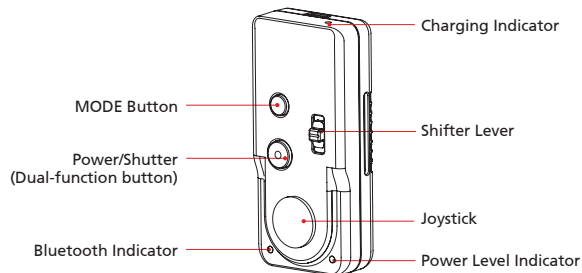
**ON/OFF & Video (Two-step shutter-release button)**

1. Fully press the button for over 1sec. to turn on the remote control and enter master mode by default.
2. Fully press the button for over 1s, when it is on to turn off the remote control (the indicator switches off accordingly)
3. While stabilizer is connected to the camera: Under Photo mode, press the shutter button halfway down to focus then fully press it to take the shot; Quickly double press the button (fully press) to switch between Video and Photo mode.

Button Combinations

Power button + Toggle: While powering on, push the toggle in the W direction to enter into Slave mode to upgrade the remote control firmware via the phone (First download the "ZY Play" App and then update).

Power button + Mode Button: Press the mode button and power button at the same time to pair the nearest stabilizer via bluetooth.

Mode button: Mode selection (sharing the same feature with gimbal)

Joystick: Directional control (sharing the same feature with gimbal)

Toggle: To zoom in/out.

⚠ Proper camera cable connection is required to control the camera. Some remote control features may not be supported for some camera models.

Specifications:

Charging voltage: 5V
 Charging current: 100mA
 Theoretical work time: ≥30 hr.
 Built-in Polymer lithium battery capacity: 150mAh
 Emission and received current: 11.9mA
 Operating current: 4.2mA
 Effective control distance: 10m /394 inch
 (without blockage)

Bluetooth Indicator

No connection: Continuous flashing.
 Connected: Shines solid light.

Power Level Indicator

90%-100%: quick flash for 4 times each second.
 75%-90%: quick flash for 3 times each second.
 55%-75%: quick flash for 2 times each second.
 30%-55%: quick flash for 1 time each second.
 0%-30%: quick flashing.

Charging Indicator

Charging: ● RED light.
 Charging complete: ● GREEN light.

Mounting Method

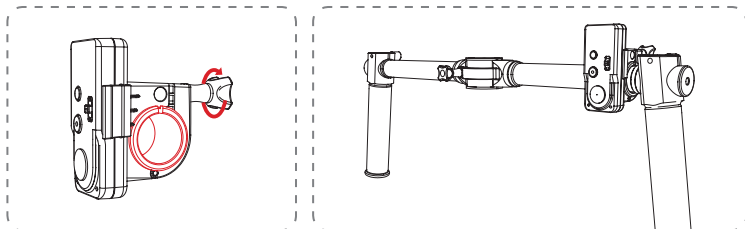

1. Loosen the thumb screw on the back of the remote controller to let loose of the rubber case (as marked red in the Figure).
2. Install the remote controller to the extension rod or dual handle for convenient operations (as shown in the Figure above). Fasten up by tightening the thumb screw on the back.

💡 The remote controller turns off automatically when left idle for 2 minutes.

Crane-EH001 CRANE Extended Handle (purchase separately)

Installation method:

1. Insert in the two handles from the two sides of the horizontal rod.
2. Tighten the screws on the handles.
3. Unscrew the fixing clamp in the middle of the handles, take out the protection ring and insert it into the stabilizer.
4. Clip the fixing clamp onto the stabilizer with the protection ring, and then tighten the screws of the fixing clamp.

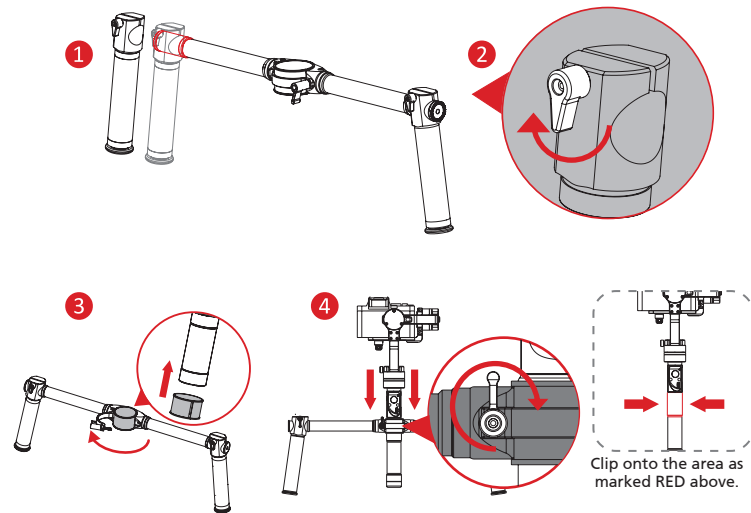

Clip onto the area as marked RED above.

Top down gesture

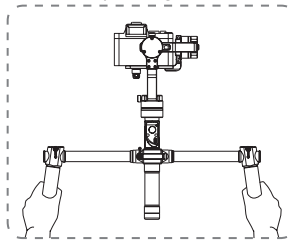

Bottom up gesture

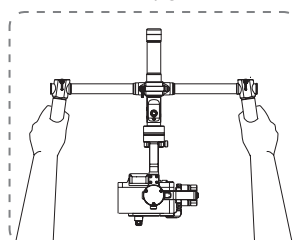

	Min	Standard	Max	Remarks
Input Voltage	6.8V	8.4V	12.6V	
Operation Current	80mA	110mA	6000mA	
Operation Temperature	-10°C	25°C	45°C	
Operation Time	12h		18h	Tested under static operation after proper balancing
Charging Time		3h		
Weight		950g		Excluding batteries
Tilt Mechanical Range		360°		Unlimited rotation
Roll Mechanical Range		360°		Unlimited rotation
Pan Mechanical Range		360°		Unlimited rotation
Payload	350g		2500g	

CRANE PLUS Firmware V1.52 and above supports parameter setting for motor force. Users can set the motor force to adapt to cameras with different weights via the calibration upgrade tool or the app.

Setting process

Adjustment method 1 :The motor force of the stabilizer needs to be adjusted (3 levels) to adapt the stabilizer to cameras and lens of different weight for ideal use. Please refer to the connection way on the APP introduction, firstly connect the Crane by ZY PLAY, then choose the suitable strength to set up the motor force in ZY PLAY correctly.

Adjustment method 2 :

1. Download the calibration upgrade tool and USB driver from Zhiyun official website. Double click to install USB driver.
2. Connected gimbal and PC by USB cable, double-click Tool to run Tool. Power on gimbal, press and hold Mode button for seconds, gimbal enter to standby mode.
3. Click "Setting" to enter to parameter setting page. Click "Open", Users can set motor power in Other Module.
4. Motor power have low, medium and high three options.
 Low: Default setting (recommend : CRANE PLUS + Sony A7S or below weight)
 Medium: Moderate setting (recommend : CRANE PLUS + Sony A7S)
 High: Maximum setting (recommend :CRANE PLUS + Canon 5D)



Warranty Period

1. Customers are entitled to replacement or free repair service in case of quality defect(s) found in the product within 15 days upon receipt of the product.
2. Customers are entitled to free repair service from ZHIYUN for any product proven defective in material or workmanship that results in product failure during normal consumer usage and conditions within the valid warranty period, which is 12 months counting from the date of delivery.
3. Some states or countries do not allow limitations on how long an implied warranty lasts, so the above warranty term may not apply to you.

This warranty does not apply to the followings

1. Products subjected to unauthorized repair, misuse, collision, neglect, mishandling, soaking, accident, and unauthorized alteration.
2. Products subjected to improper use or whose labels or security tags have been torn off or altered.
3. Products whose warranty has expired.
4. Products damaged due to force majeure, such as fire, flood, lightning, etc.

Warranty Claim Procedure

1. If failure or any problem occurs to your product after purchase, please contact a local agent for assistant, or you can always contact ZHIYUN's customer service through email at service@zhiyun-tech.com or website at www.zhiyun-tech.com.
2. Your local agent or ZHIYUN's customer service will guide you through the whole service procedure regarding any product issue or problem you have encountered.
3. ZHIYUN reserves the right to reexamine damaged or returned products.

Custom information

Customer Name :

Contact No :

Address :

Sales Information

Sales Date :

Prod. Serial No :

Dealer

Contact No :

#1 Maintenance Record

Service Date :

Signature of Repairman :

Cause of Problem :

Service Result :

Solved

Unsolved

Refunded(Replaced)

💡 Search and follow "Zhiyun Tech" on Facebook, Instagram, Twitter, YouTube and Vimeo to connect with us.

Tel: +86-773-2320856

USA Hotline: +1 808-319-6137,9:00-18:00 GMT-7,Mon-Fri

Europe Hotline: 0031-297303057,10:00-17:00 GMT+1,Mon-Fri

Web: www.zhiyun-tech.com

E-mail: service@zhiyun-tech.com

Address: 6th floor Building No.13 Creative Industrial Park, GuiMo Road, Qixing District, Guilin

Certificate of Quality

This product is confirmed to meet quality standards and permitted for sale after strict inspection.

QC Inspector: _____

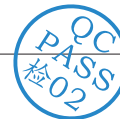

Please download the latest version from www.zhiyun-tech.com
This document is subject to change.
ZHIYUN™ is a trademark of ZHISHEN.
Copyright © 2018 ZHISHEN. All rights reserved.

ZHIYUN-TECH.COM