

StarBlueDisc Toiletblokhouder

Insert for in-cistern block

Einwurfschacht

le support de plaque pour insertion de bloc d'eau bleue

Installation Manual

Specially designed for:

- Geberit UP100 - Delta Systems.
- Geberit UP300, UP320 & Sigma 12 cm Systems.

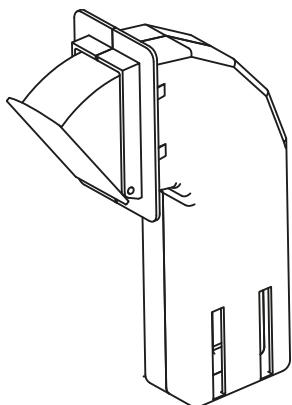
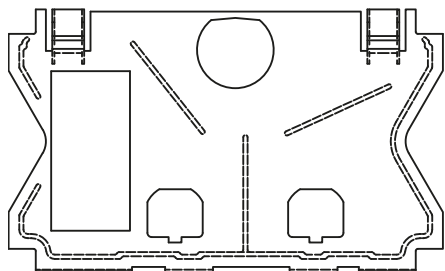
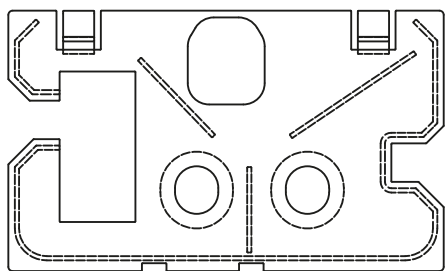

Art.nr. 201.591.252

UP100 - Delta Systems.

- NL:** Heeft u één van de Bedieningsplaten uit dit overzicht?
- EN:** Do you have one of the actuator plates from this overview?
- DE:** Haben Sie eine Betätigungsplatte aus dieser Übersicht?
- FR:** Avez-vous une des plaques de contrôle de cet aperçu?

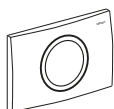

Delta 11

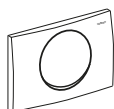

Delta 15

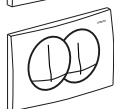

Delta 20

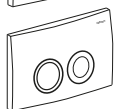

Delta 21

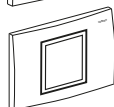

Delta 40

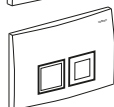

Delta 50

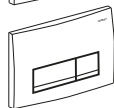

Delta 51

- NL:** Gebruik dit serviceluis.
- EN:** Then use this backplate.
- DE:** Verwenden Sie dann diese Schutzplatte.
- FR:** Utilisez cette plaque de protection.

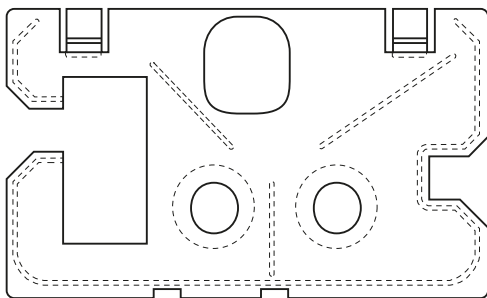

Specially designed for
UP100 - Delta Systems.

UP300, UP320 & Sigma 12 cm. Systems

- NL:** Heeft u één van de Bedieningsplaten uit dit overzicht?
- EN:** Do you have one of the actuator plates from this overview?
- DE:** Haben Sie eine Betätigungsplatte aus dieser Übersicht?
- FR:** Avez-vous une des plaques de contrôle de cet aperçu?

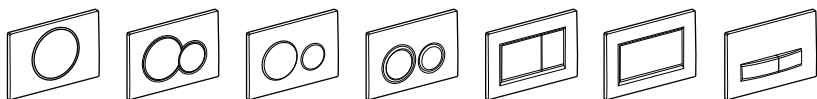

Sigma 10 Sigma 01 Sigma 20 Sigma 21 Sigma 30 Sigma 30-1 Sigma 50

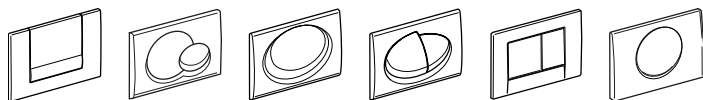

Tango Samba Rumba Twist Bolero Mambo

- NL:** Gebruik dit serviceluis.
- EN:** Then use this backplate.
- DE:** Verwenden Sie dann diese Schutzplatte.
- FR:** Utilisez cette plaque de protection.

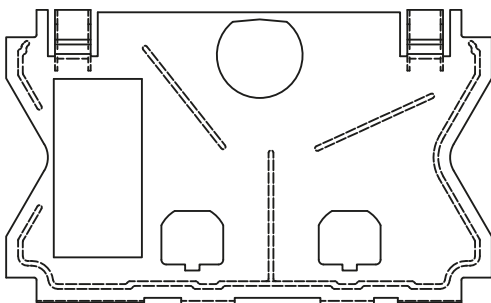

Specially designed for
UP300, UP320 & Sigma 12 cm. Systems

1

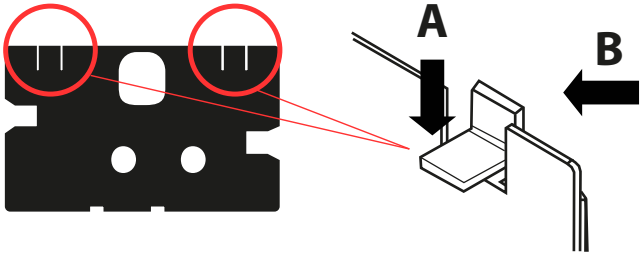

- NL:** Verwijder het Geberit Serviceluiк.
- EN:** Remove the Geberit Backplate.
- DE:** Entferne die Geberit Schutzplatte.
- FR:** Supprimer la plaque de protection Geberit.

- NL:** Kies een Serviceluiк, op basis van de overzichten.
- EN:** Choose Backplate based on the overviews.
- DE:** Wählen Sie Schutzplatte, basierend auf den Übersichten.
- FR:** Choisissez la plaque arrière, en fonction des aperçus.

2

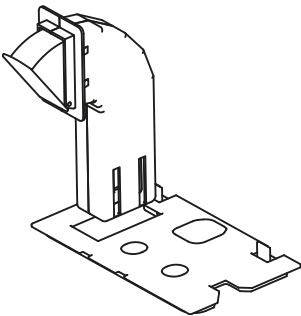

3

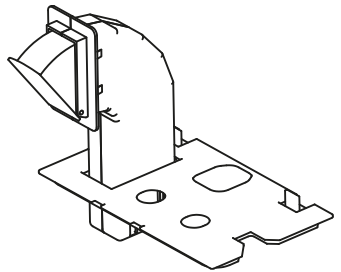

4

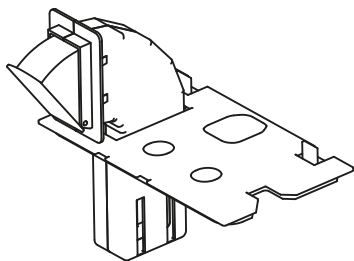

5

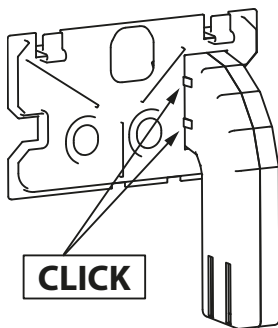

6

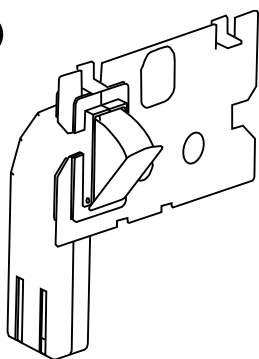

NL: Plaats Toiletblokhouder waar serviceluik voorheen zat.

EN: Place insert where backplate was before.

DE: Installiere Einwurfschacht wo Schutzplatte zuerst war.

FR: Placez le insert sur la place la plaque de protection.



Varda 30
5661 AE Geldrop
+31 40 7440585
info@starbluedisc.nl
www.starbluedisc.nl

**Wij adviseren
We recommend
Wir empfehlen
Nous recommandons**



StarBlueDisc Toiletblocks

www.starbluedisc.nl
info@starbluedisc.nl