

GENERALSCAN

QUICK USER GUIDE

FOR WEARABLE BLUETOOTH SCANNERS

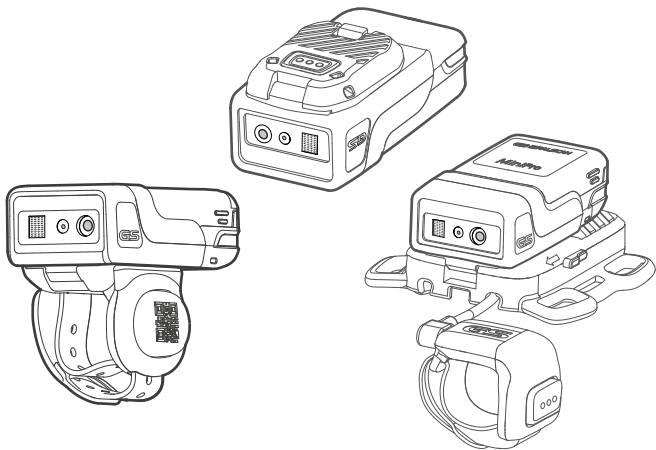

EN

R1120/R152#/R352#/R552#
Ring Scanner / Thumbbutton Scanner / Ruglove Scanner

Introduction

This Guide is applicable to all GS Wearable Scanners. For detailed information please refer to this guide. If there are any further questions, please contact support@generalscan.cloud.

Copyright

GENERALSCAN trademarks are registered in many countries around the world. Generalscan Inc. and/or its subsidiaries, all rights reserved. No part of this publication may be reproduced or used in any form, or by any electrical or mechanical means, without permission in writing. The material in this manual is subject to change without notice. All software without license shall not be transferred to others.

Laser Safety

Do not stare into the laser beam or view directly with optical instruments.

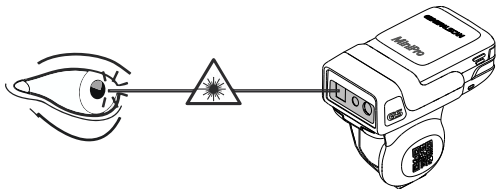

Battery Safety

- Do not immerse or expose to water or other liquids, or expose to fire, explosion, or other hazard.
- Do not disassemble or open, crush, bend or deform, puncture, or shred.
- Do not short circuit a battery or allow metallic or conductive objects to contact the battery terminals.
- Do not use the battery if it is bulging, deformed or damaged.
- To charge the mobile device battery, the battery and charger temperatures must be between +32 °F and +104 °F (0 °C and +40 °C).
- Do not use batteries other than those provided by GENERALSCAN, otherwise we will not be responsible for the consequences.
- Dispose of batteries according to instructions.
- Please follow local regulations to promptly dispose of used rechargeable batteries.

GS R1120 & GS R152# Ring Scanners

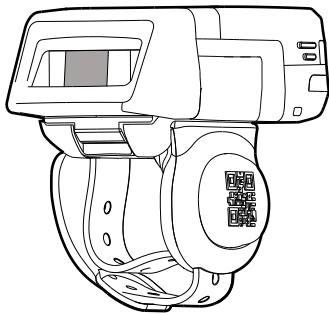

GS R1120 Ring

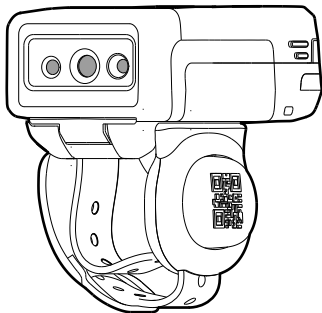

GS R152# Ring

GS R352# & GS R552# Ring Scanners

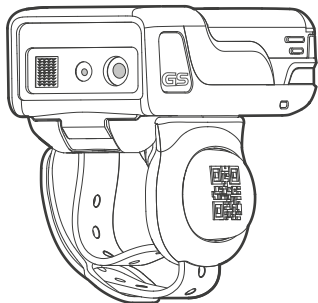

GS R352# Ring

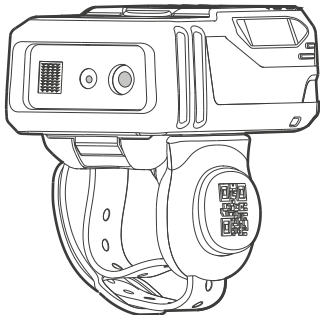

GS R552# Ring

GS R1120 & GS R152# Thumbbutton Scanners

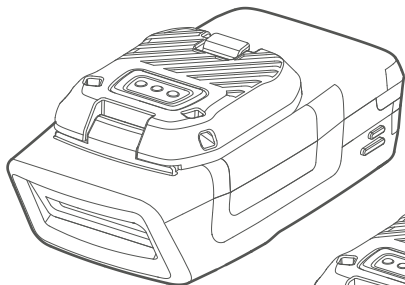

GS R1120
Thumbbutton

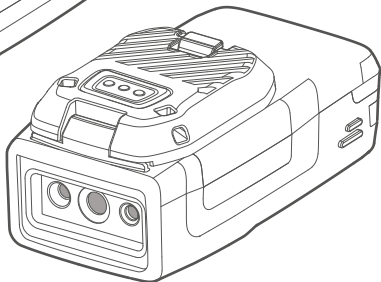

GS R152#
Thumbbutton

GS R352# & GS R552# Thumbbutton Scanners

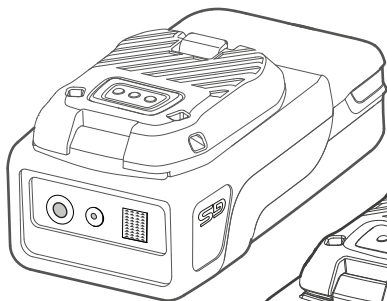

GS R352#
Thumbbutton

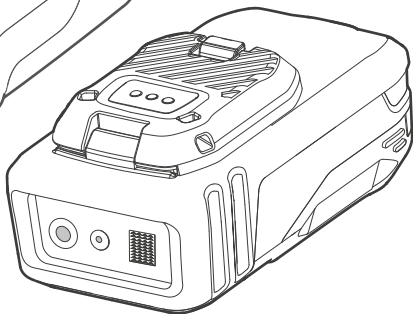

GS R552#
Thumbbutton

GS R1120 & GS R152# Ruglove Scanners

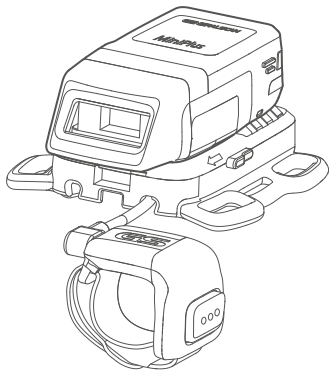

GS R1120 Ruglove

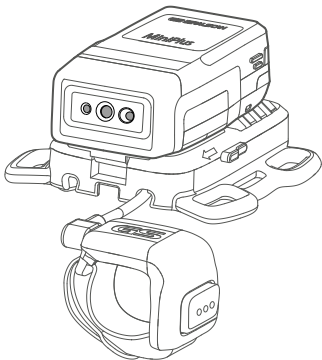

GS R152# Ruglove

GS R352# & GS R552# Ruglove Scanners

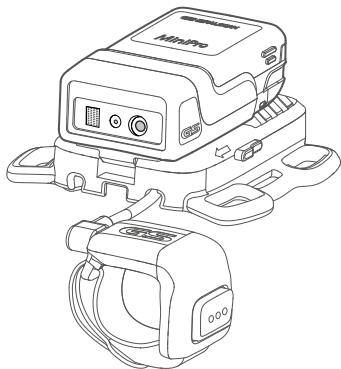

GS R352# Ruglove

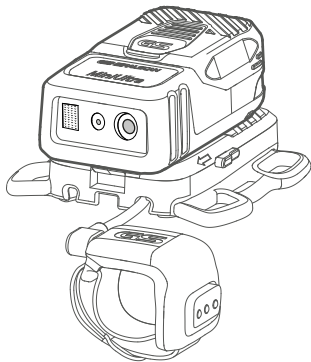

GS R552# Ruglove

Ring Scanner Side View

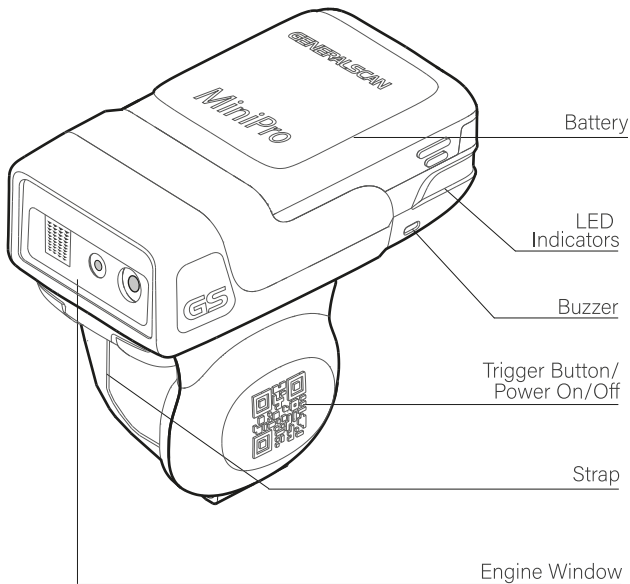

Ring Scanner Back View

Turn ON/OFF

Turn ON the scanner after pressing and holding scanner's trigger button for 1.5 seconds.

Turn OFF the scanner after pressing and holding scanner's trigger button for 5 seconds.

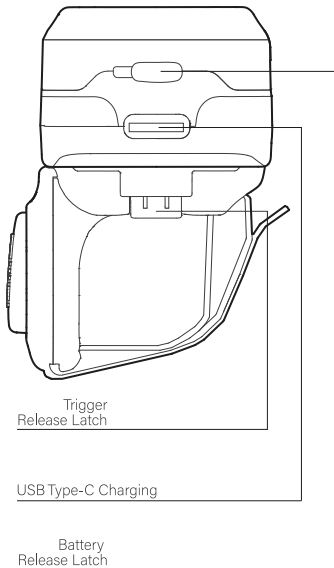

Ring Scanner Setup - Descriptions

Figure 1 Install the Trigger

Determine whether ring scanner is used on the right or left hand and rotate the trigger assembly accordingly, so that the Trigger is positioned next to the thumb when ring scanner is placed on the index finger. Align one end of the Trigger on ring scanner.

Figure 2 Assemble the Trigger

Push the other end down until it snaps into place.

Removing the Trigger

Push the yellow latch in, while lifting the Trigger away from the scanner body.

Note: All steps are applicable to every GS Ring Scanners.

Ring Scanner Setup

Figure 1

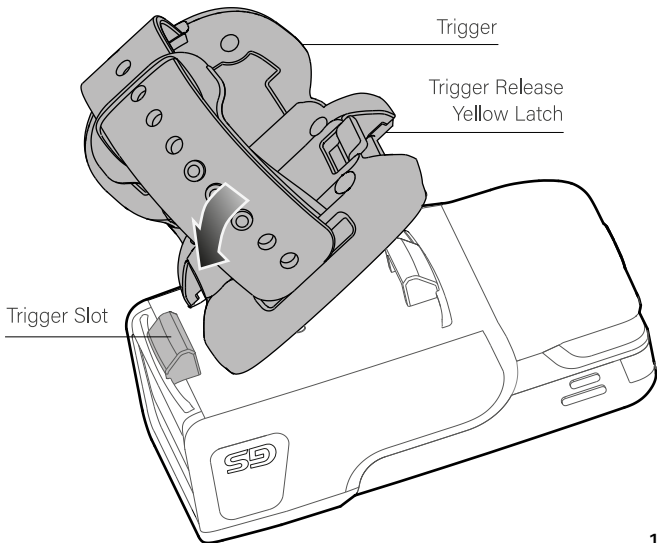

Ring Scanner Setup

Figure 2

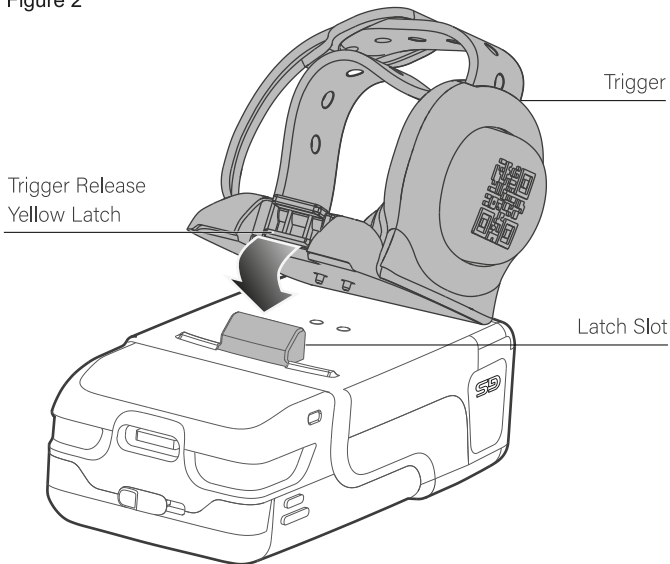

Thumbbutton Scanner Side View

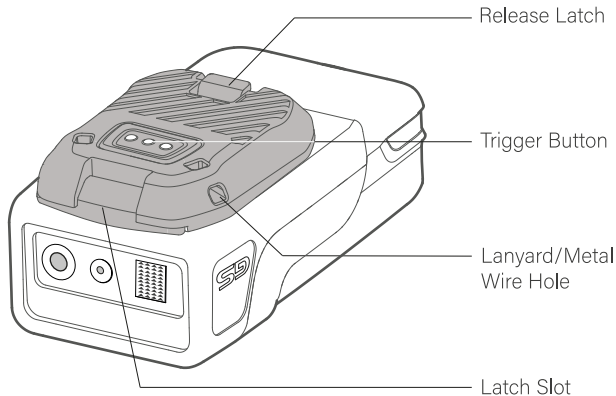

Thumbbutton Accessories

- * Adjustable Metal Wire
- * Lanyard

Thumbbutton Scanner Setup

Insert the tabs on the Thumbbutton into the gaps.

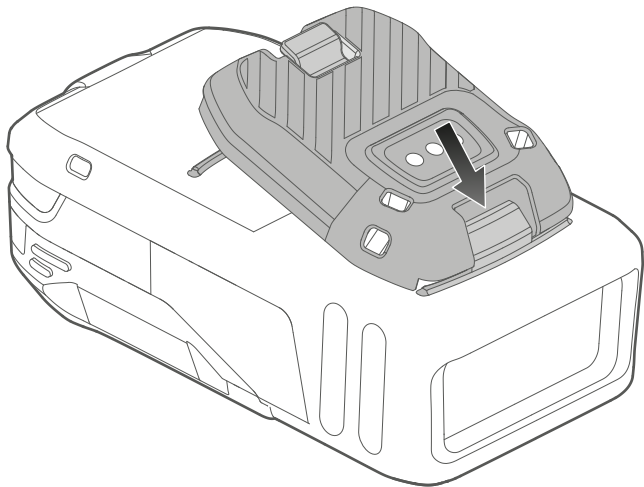

Thumbbutton Scanner Setup

Place the Thumbbutton latch into the compartment.

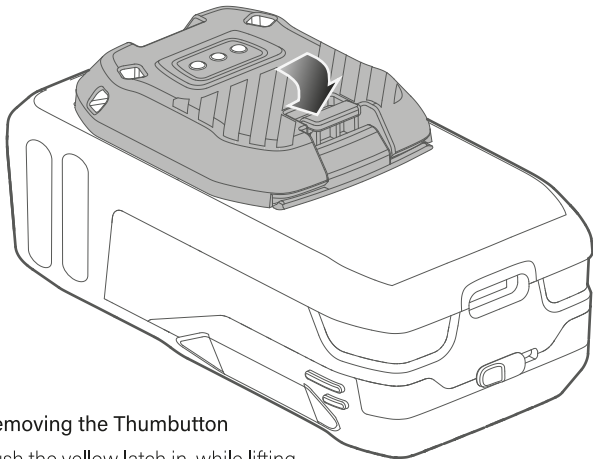

Removing the Thumbbutton

Push the yellow latch in, while lifting the Thumbbutton away from the scanner body.

Ruglove Top and Back View

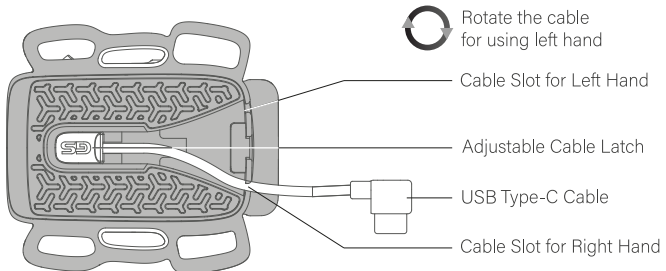

Back View

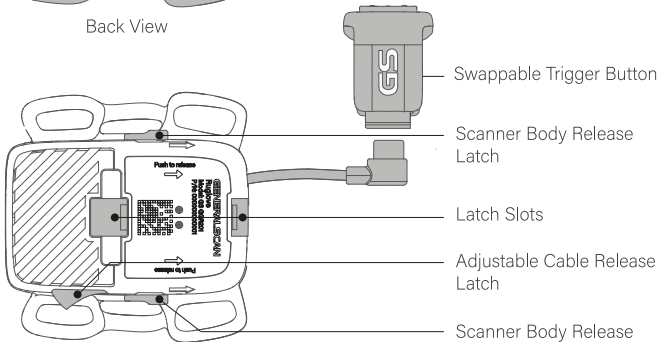

Top View

Ruglove Scanner Setup

- ① Insert the tabs on the Scanner Body into the gaps.
- ② Place the Scanner Body latch into the compartment.

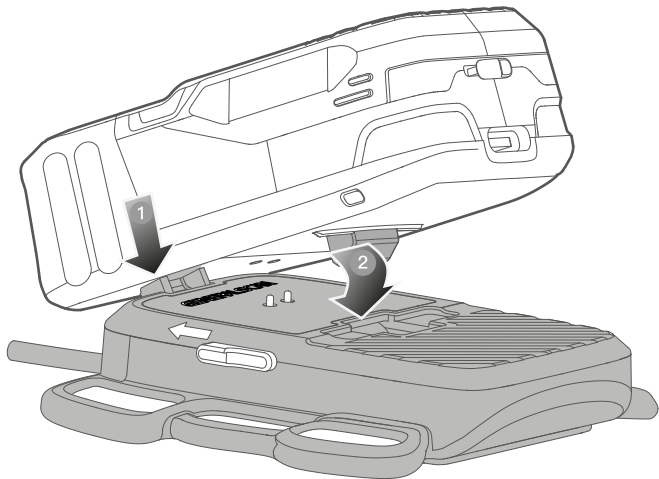

Ruglove Trigger Button Setup

Connect the trigger button to Ruglove with USB Type-C, compatible with Left and Right hand wearing habits.

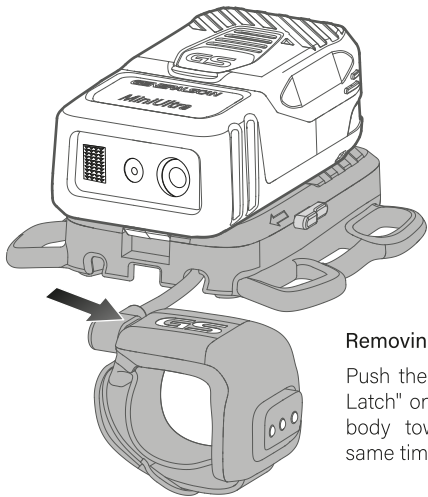

Removing the Scanner Body

Push the "Scanner Body Release Latch" on both sides of the glove body towards the front at the same time.

Battery Setup

Insert the tabs on the battery into the gaps.

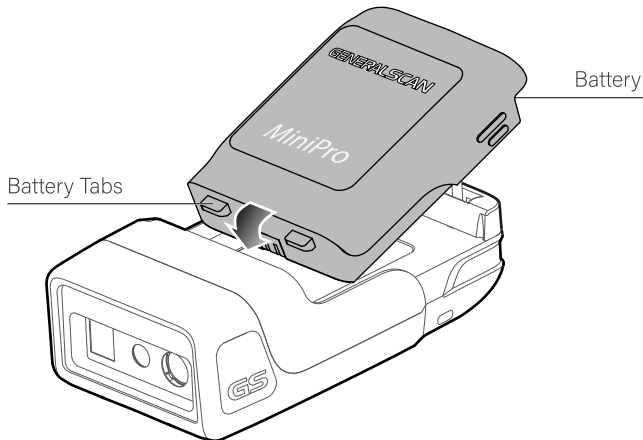

Battery Setup

Place the battery in the battery compartment

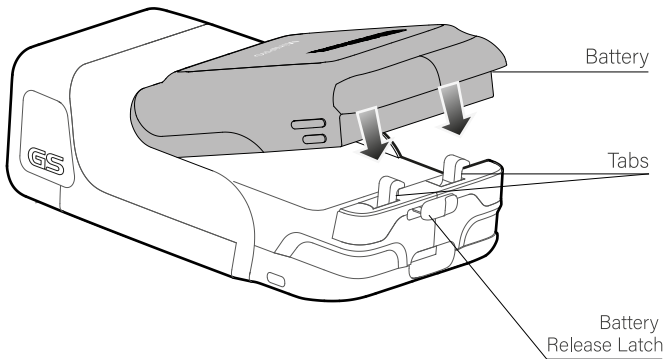

Removing the Battery

To remove the battery, please push the release latch on the back of the scanner to the left, then remove the battery with the tabs on the right and left of the battery.

Battery Charging

Please use the cable packed in the box. Place the battery in the charger as follows. Align end of the battery-① on the charger. Pull out the retractor-②. Push the other End-③ into the compartment. Then connect the charger to the computer.

Note: In addition, the scanners can be charged directly with a 5V power source with the USB Type-C cable in the package.

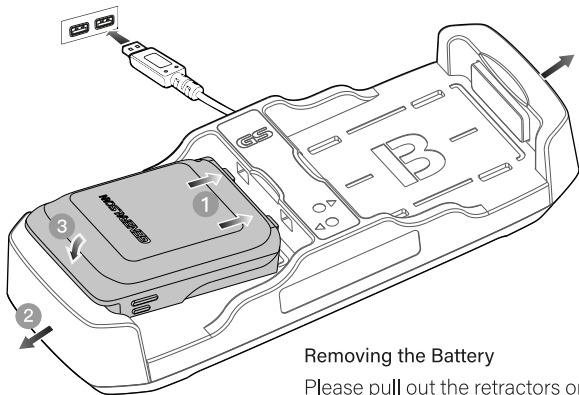

Removing the Battery

Please pull out the retractors on either side of the charger before take the battery out of the compartment.

Optional Accessories

1



2

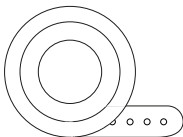

3

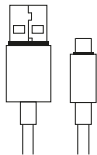

4

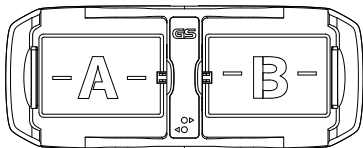

Standard package content

- 1. Battery
- 2. Strap
- 3. USB Type-C Cable
- 4. Battery Charger

All accessories are compatible with every GS Wearable Scanners. 24

LED Status

Status	Description
Green LED blinks one time	Decode successfully
Green LED is blinking continuously	Low battery alarm
Red LED turns on	Charging
Red LED turns off	Charging 100%
Blue LED is blinking continuously	Start Bluetooth pairing
Blue LED turns off	Bluetooth pairing successfully

Scanning Techniques

Please aim at the middle of the barcode through the red light when scan the barcode. Please scan properly in accordance with the following diagram. Adjust the scanner angle and distance slowly, at the same time, press the trigger button, make the center red light cover the left to right of the barcode.

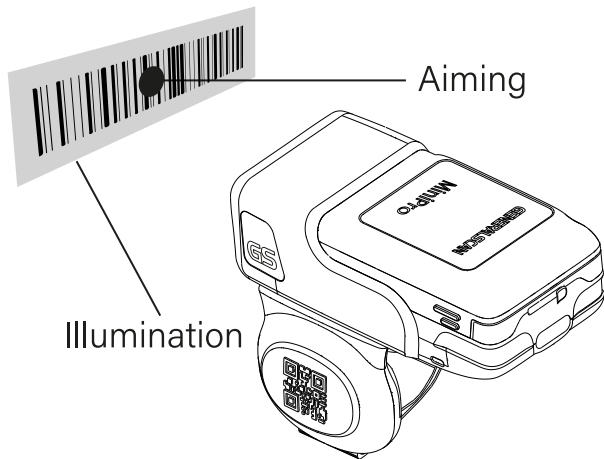

GENERALSCAN Applications

GENERALSCAN is always with you with our after-sales team! G-Service, Generalscan Keyboard Pro are mobile applications that assist you after-sales. Scan the QR code below and make full use of the unique service.



G-SERVICE



iCode



GS Keyboard Pro

More Language

This Guide is written in English. Please scan below barcodes with your phone to get access to other languages.



Deutsch



Español



Русский



日本語



한국어



中文



Português



Français



Türkçe



English



Warranty Information

For Generalscan products warranty information, please visit www.generalscan.com/warranty.



Service Information

If there is any problem of GENERALSCAN barcode scanners, please visit our service page, www.generalscan.com/service.

GENERALSCAN

QUICK USER GUIDE
FOR WEARABLE BLUETOOTH SCANNERS

Email: Support@generalscan.cloud

©2022 GENERALSCAN All rights reserved.
Version 2.0



886783001001