

User Manual

HD PoE IP Camera



Model: FI9853EP

Table of Contents

Security Warning.....	1
1 Overviews.....	1
1.1 Key Features.....	1
1.2 PoE (Power over Ethernet).....	2
1.3 Read before Use.....	2
1.4 Packing Contents.....	2
1.5 Physical Description.....	3
1.6 Hardware Installation.....	4
1.7 Instructions for outdoor installation.....	5
2 Accessing the Network Camera.....	6
2.1 Access the Camera in LAN.....	6
2.2 Access the Camera in WAN.....	7
2.3 Using the VLC Player.....	10
3 Surveillance Software GUI.....	13
3.1 Login Window.....	13
3.2 Setup Wizard.....	14
3.3 Surveillance Window.....	16
4 Advanced Camera Settings.....	20
4.1 Status.....	20
4.2 Basic Settings.....	22
4.3 Network.....	29
4.4 Video.....	43
4.5 Detector.....	46
4.6 Record.....	49
4.7 Firewall.....	51
4.8 System.....	51
5 Appendix.....	55
5.1 Frequently Asked Questions.....	55
5.2 Default Parameters.....	62
5.3 Specification.....	62
5.4 CE & FCC.....	63
5.5 Warranty.....	64
5.6 Statement.....	66
6 Obtaining Technical Support.....	67

Security Warning

1. Please change the password of your camera regularly, using a combination of numbers, letters and special characters.
2. We recommend that you regularly update your camera to the latest available software and firmware versions to help ensure the best experience for your camera.

1 Overviews

The camera is integrated IP Camera with a color CMOS sensor enabling viewing resolution 1280 * 720. It combines a high quality digital video camera, with a powerful web server, to bring clear video to your desktop from anywhere on your local network or over the Internet.

They support the industry-standard H.264 compression technology, drastically reducing file sizes and conserving valuable network bandwidth.

The IP camera is based on the TCP/IP standard. There is a WEB server inside which could support Internet Explorer. Therefore the management and maintenance of your device is simplified by using the network to achieve the remote configuration and start-up.

The camera is designed for outdoor and indoor surveillance applications such as courtyards, supermarket, and school. Controlling the IP camera and managing images are simplified by using the provided web interface across the network.

FOSCAM provides Phone apps for Android and iPhone users, please search Foscam app named **Foscam Viewer** on app Store or Google Play, then you can view your camera directly as a computer.

1.1 Key Features

- ◆ Standard H.264 video compression algorithm to satisfy the transmission of high definition video in narrow bandwidth network
- ◆ 1.0 Mega-Pixel
- ◆ Supports IE / Firefox / Google / Safari browser or any other standard browsers
- ◆ Supports WEP, PA and WPA2 Encryption
- ◆ IR Range, IR range up to 20m / 66ft
- ◆ Supports image snapshot
- ◆ Supports dual-stream
- ◆ Supports IR-Cut and the filter change automatically
- ◆ Embedded FOSCAM DDNS(dynamic domain name service) Service
- ◆ Supports remote viewing & record from anywhere anytime
- ◆ Multi-level users management with password protection
- ◆ Motion detection alert via email or upload image to FTP
- ◆ Supporting Third Party Domain name
- ◆ Providing Phone apps for Android and iPhone users

- ◆ Supports multiple network protocols: HTTP / HTTPS / RTSP / TCP / IP / UDP / FTP / DHCP / DDNS / UPNP / ONVIF
- ◆ Providing Central Management Software to manage or monitor multi-camera

1.2 PoE (Power over Ethernet)

The Network Camera is PoE-compliant, allowing transmission of power and data via a single Ethernet cable. Such as the following picture: connect the Network Camera to a PoE-enabled router / switch via Ethernet cable.

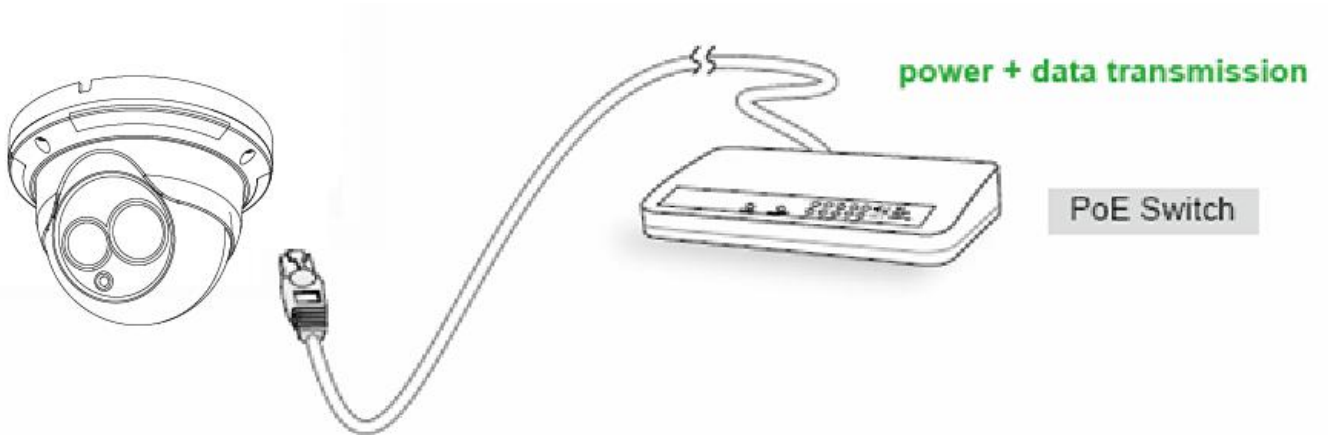

1.3 Read before Use

Please first verify that all contents received are complete according to the Package Contents listed below. Before the Network Camera is installed, please carefully read and follow the instructions in the Quick Setup Guide to avoid damage due to faulty assembly and installation. This also ensures the product is used properly as intended.

1.4 Packing Contents

● IP camera * 1	● CD * 1
● DC Power Supply * 1	● Quick Setup Guide * 1
● Warranty Card * 1	

1.5 Physical Description

1.5.1 Front Panel



1 Infrared Lamp Array

2 LENS: CMOS sensor with fixed focus lens

3 Induction IC

1.5.2 Interface



1 Power Interface

Connect the external power adapter, request for 12V/1A power.

2 LAN

10/100M adaptive Ethernet interface. Through this interface, IP camera can be connected with various network devices, such as hub, router, etc.

3 Reset button

Press and hold on the reset button for 5 seconds. Releasing the reset button, the password will back to the

factory default administrator password. The default administrator user is admin with no password.

1.5.3 Bottom View

There are two labels located at the bottom of the camera; this is an important feature of original Foscam cameras. If your camera does not have labels, it may be a clone. Cloned Foscam cameras can not use original firmware and are not eligible for warranty or technical services.

1.6 Hardware Installation

1. Loosen the three screws on the base of the camera, remove the camera base.

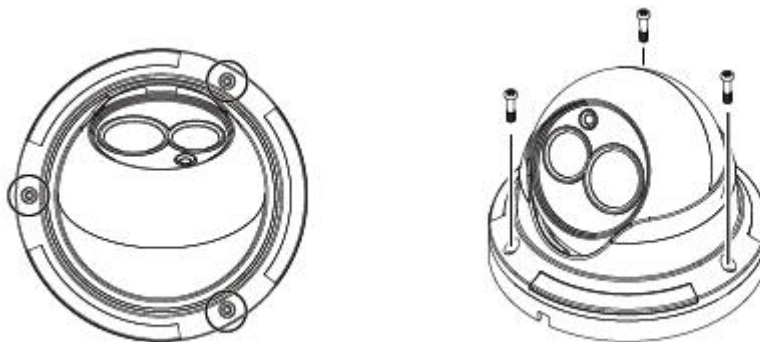

2. According to the monitored area, install the base of the camera on the ceiling or wall with expansion screws.
3. Assembly the sphere, cover and decorative ring of the order, according to the monitored area to turn the angle of the sphere. Finally, fix the decorative ring and the base with screws.

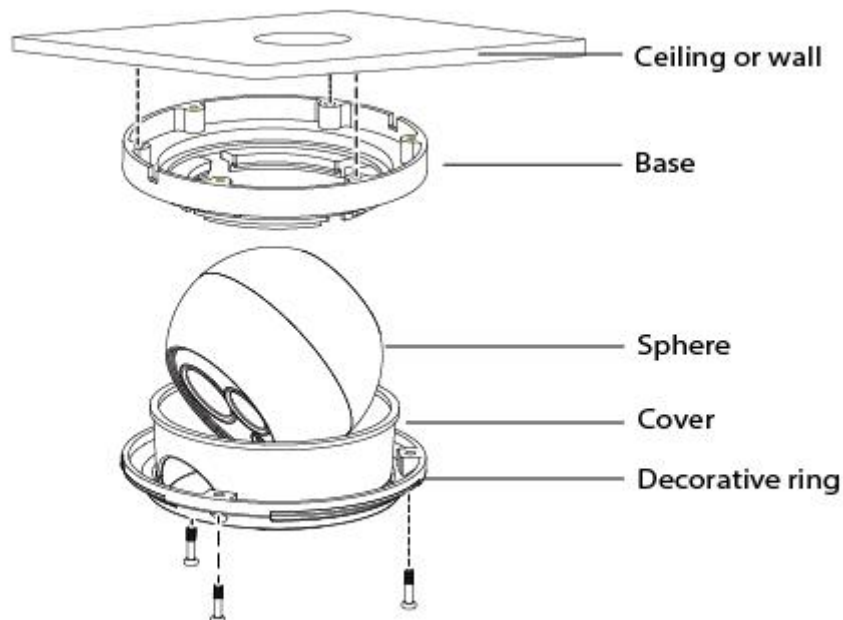

1.7 Instructions for outdoor installation

The cable of an outdoor camera should, from the position where the cable is divided into several cables, be fitted dry. Install the cable into a waterproof junction box (1) or bring the cable indoors (2).

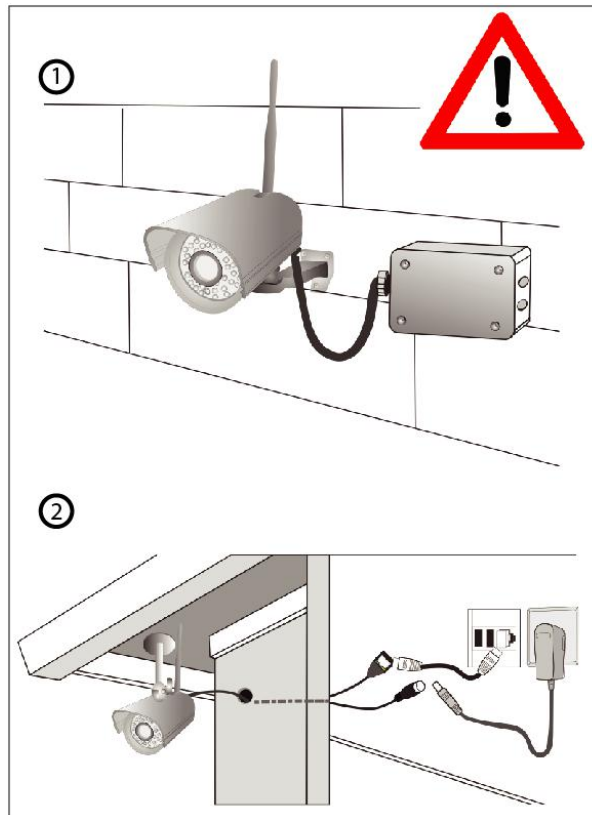

2 Accessing the Network Camera

This chapter explains how to access the network camera through web browsers and RTSP players.

2.1 Access the Camera in LAN

This camera support HTTP and HTTPS protocols, so here will allow you to use HTTP and HTTPS port No.

(1) Http:// LAN IP + Http Port No.

Double click the Equipment Search Tool icon and it should find the camera's IP address automatically after you plug in the network cable.

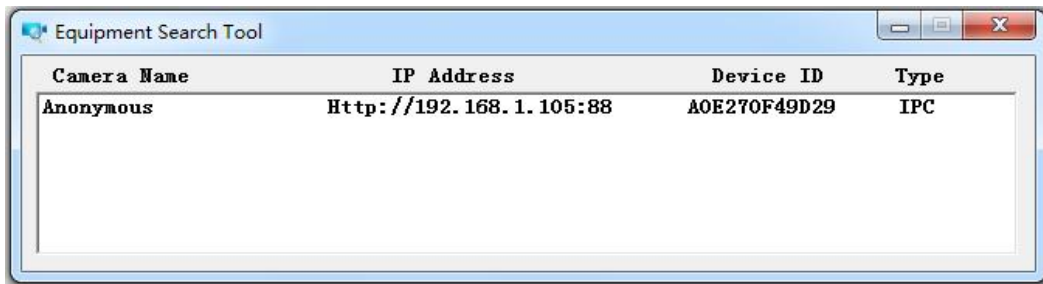

Double click the IP address of the camera; your default browser will open to the camera login page.

(2) Https:// LAN IP + Https Port NO.

The default Https port no. is 443. You can use the url to access the camera: **https:// LAN IP + HTTPS port.** Go to **Settings > Network > Port** panel, you can see and change the https port NO.



NOTE:

When logging in for the first time, you will need to download and install the add-on.

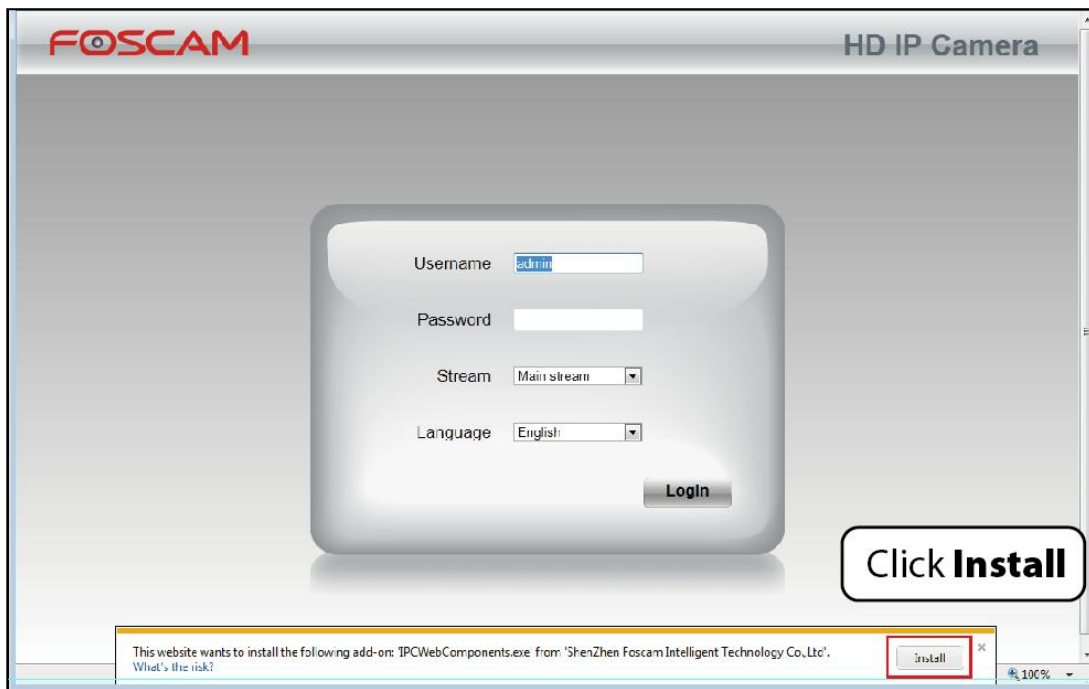

2.2 Access the Camera in WAN

2.2.1 Static IP Addresses

Users who have static IP addresses do not need to set DDNS service settings for remote access. When you have finished connecting the camera using the LAN IP address and port forwarding, you can access the camera directly from the Internet using the WAN IP address and port number.

How to Obtain the WAN IP address from a public website?

To obtain your WAN IP address, enter the following URL in your browser: <http://www.whatismyip.com>. The webpage at this address will show you the current WAN IP.



2.2.2 Remote Access

If you want to access your camera by web browser outside of your LAN, you need to configure following configurations.

1. Choose **Settings** on the top of the camera web page, then go to the **Network > IP Configuration** section on the left side of the screen, then uncheck the Obtain IP DHCP.

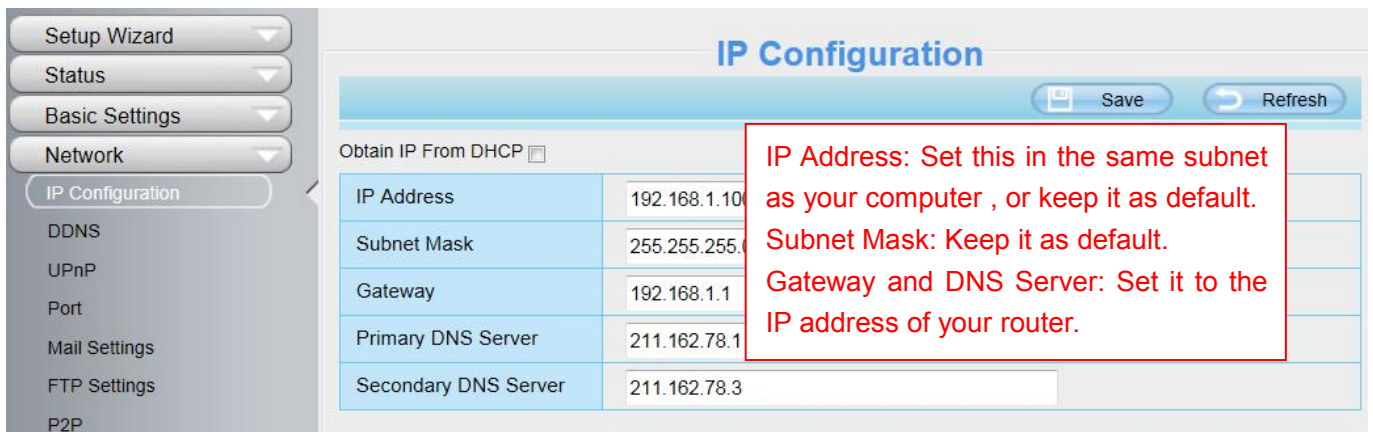

IP Configuration

Obtain IP From DHCP

IP Address	192.168.1.10
Subnet Mask	255.255.255.0
Gateway	192.168.1.1
Primary DNS Server	211.162.78.1
Secondary DNS Server	211.162.78.3

IP Address: Set this in the same subnet as your computer, or keep it as default.
Subnet Mask: Keep it as default.
Gateway and DNS Server: Set it to the IP address of your router.

2. Enable UPnP and DDNS in the camera's settings page. We recommend you to use the DDNS by factory default.

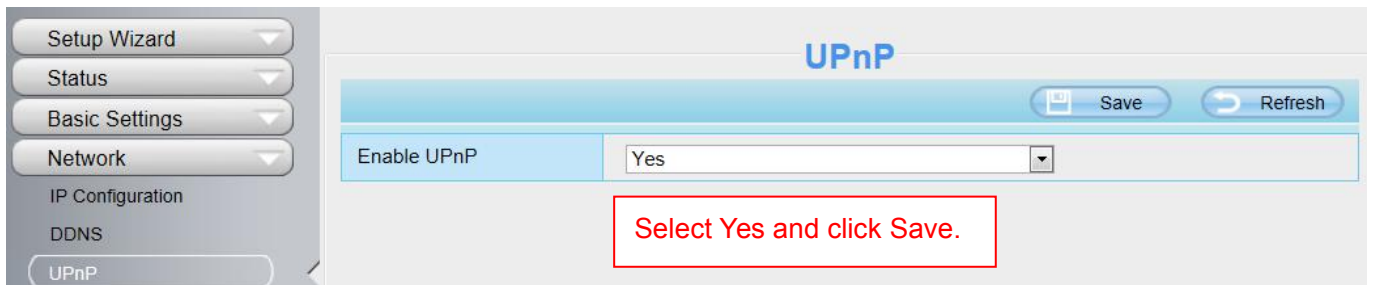

UPnP

Enable UPnP: Yes

Select Yes and click Save.

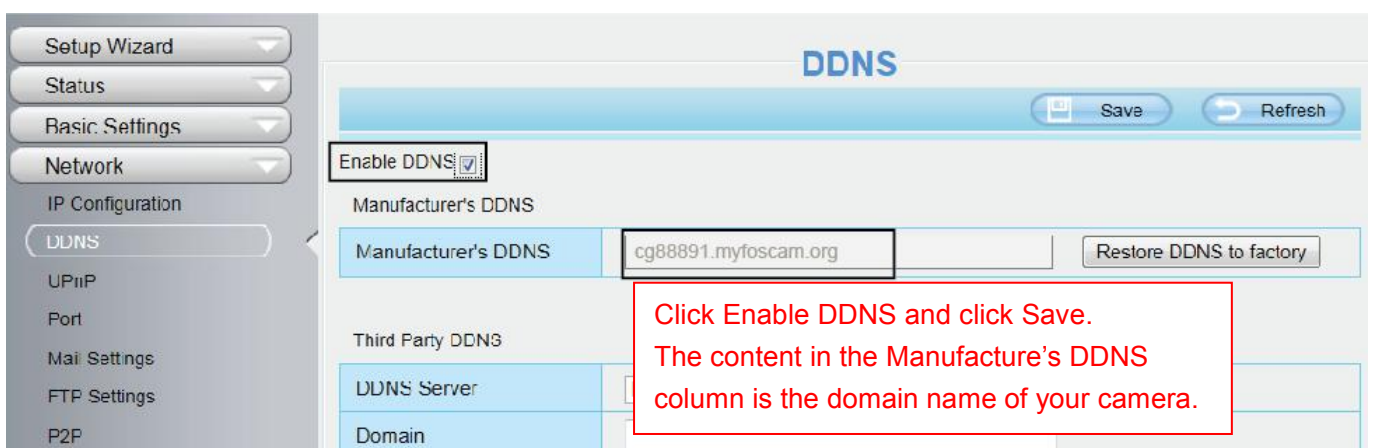

DDNS

Enable DDNS

Manufacturer's DDNS: cg88891.myfoscam.org

Click Enable DDNS and click Save.
The content in the Manufacture's DDNS column is the domain name of your camera.

3. You can see the port of your camera here. If you want to set Remote Access for several cameras on the same network, you will need to change the HTTPS port for each camera.

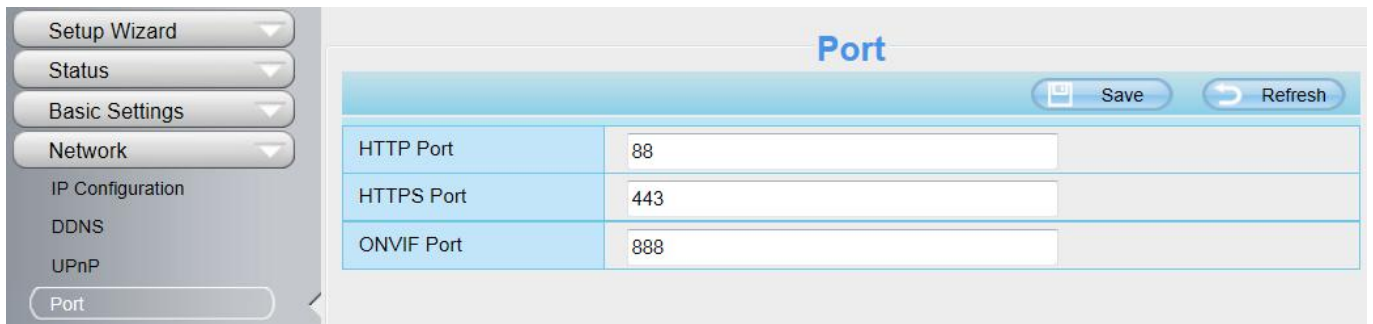

4. If the UPnP of the router has been enable, you do not need to perform following steps. Otherwise, you need to select one of the following methods to configure port forwarding on your router. For these steps, we will be using the TP-LINK brand wireless router as an example.

- **If there is a UPnP function in your router:**

Choose **Forwarding > UPnP**, make sure that the Current UPnP Status is Enabled.

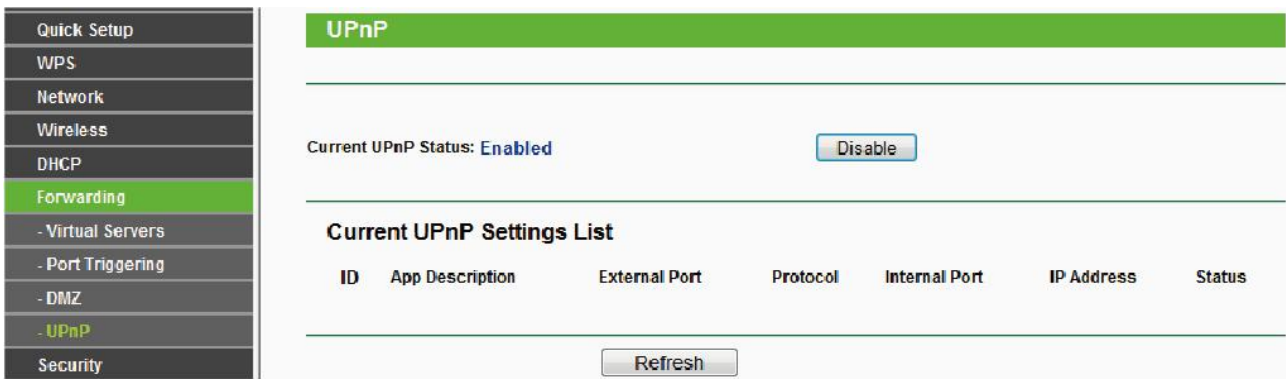

- **If there is no UPnP function in your router:**

You need to manually add port forwarding, refer to the following steps. You need go to the **Forwarding > Virtual Servers** panel for setup.



Add or Modify a Virtual Server Entry

Service Port: (XX-XX or XX)

Internal Port: (XX, Only valid for single Service Port or leave a blank)

IP Address:

Protocol: ALL

Status: Enabled

Common Service Port: --Select One--

Input the port and IP address of your camera and click Save.

Virtual Servers

ID	Service Port	Internal Port	IP Address	Protocol	Status	Modify
1	443	443	192.168.1.100	ALL	Enabled	Modify Delete

Here you have finished the Port Forwarding setup.

5. Now you can access your IP camera by <https://domain name: HTTPS port via the Internet>.

2.3 Using the VLC Player

This camera supports RTSP streaming, here you can view the camera using VLC player.

RTSP URL [rtsp:// \[user name\]:password@IP:HTTP port number/videosream](rtsp://[user name]:password@IP:HTTP port number/videosream)

The part in the square brackets may be omitted.

user name & password:

The user name and password to access the camera. This part can be omitted.

IP: WAN or LAN IP address.

Videostream: Here support three modes: videoMain, videoSub and audio. When the network speed is bad, here you had better select videoSub.

For example:

IP: 192.168.1.11

HTTP Port number: 88

User name: admin

Password: 123

Here I can enter one of the following URLs in the VLC.

1. rtsp://admin:123@192.168.1.11:88/videoMain
2. rtsp:// @192.168.1.11:88/videoMain
3. rtsp://:123@192.168.1.11:88/videoMain
4. rtsp://admin@192.168.1.11:88/videoMain

Open the VLC, and go to Media (Open Network Stream option, then enter the URL into VLC).

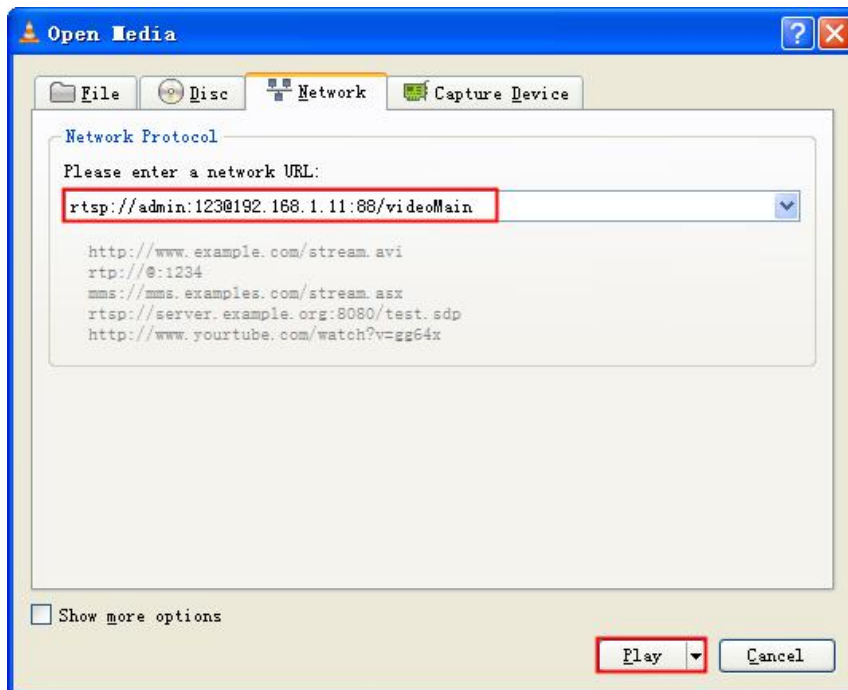
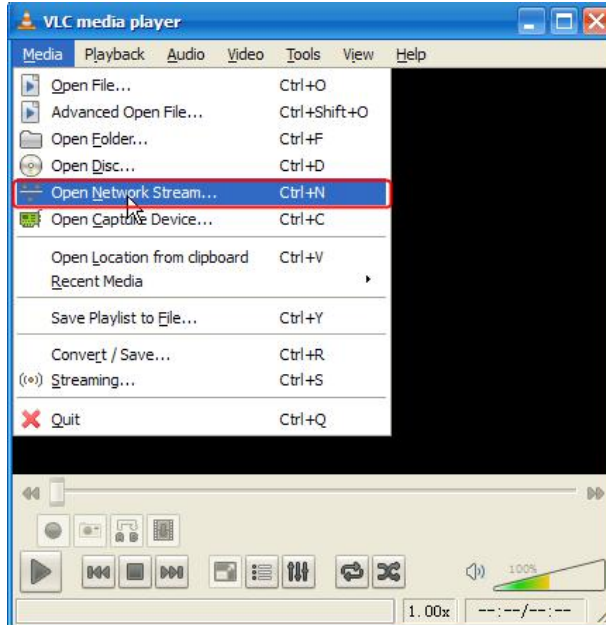

Sometimes you may need to enter the user name and password again. Click **OK** and you can see the real-time preview.

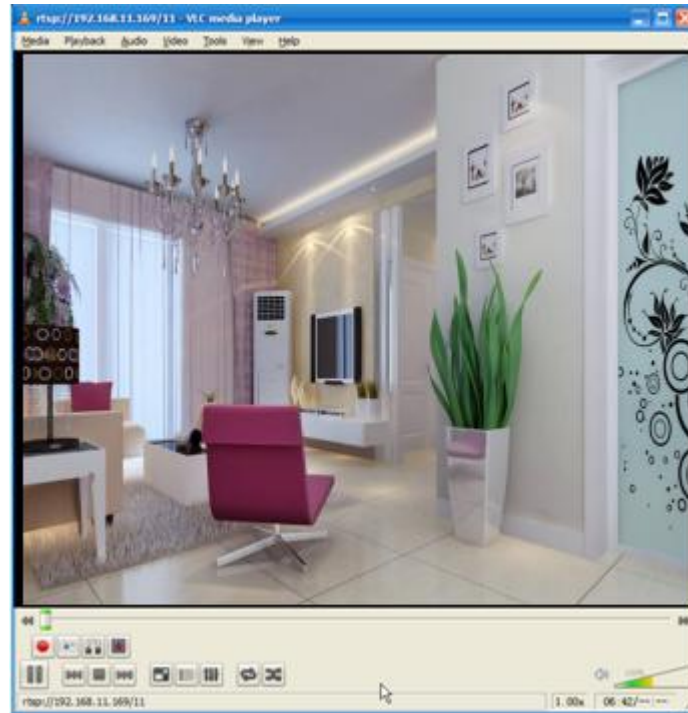

If you cannot play the video in the VLC player, please check the port mapping.

NOTE:

If you modify the camera's username or password, you had better reboot the camera, or else the new username and password cannot take effect when you enter the authentication in the VLC.

3 Surveillance Software GUI

Please refer to the Quick Setup Guide if you install the camera at first time. After finishing quick installation, you can take time to learn the operation of the software.

3.1 Login Window

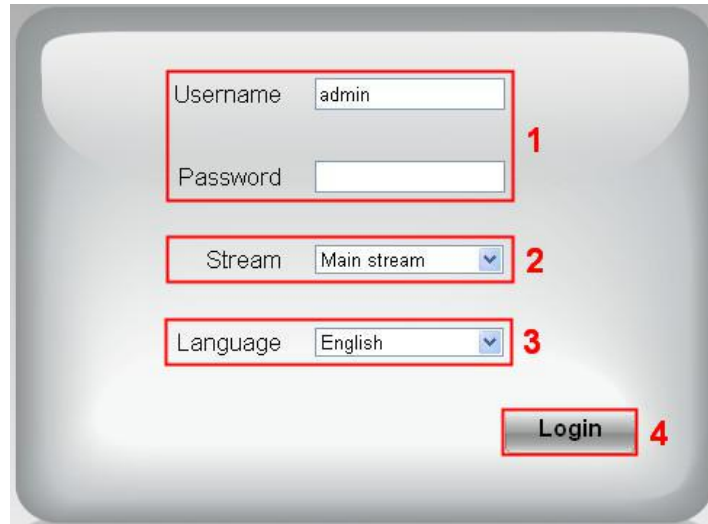

Section1 Enter the Username and password

The default administrator username is admin with no password, please reset the password at first using and prevent unauthorized users login the camera (read chapter 3.2.4 about how to change).

Section2 Stream

The camera supports two stream modes: Main stream and sub stream. If you want to access the camera form LAN, here you can select Main stream. If you want to access the camera from Internet, here we recommend sub stream.

NOTE: When the network bandwidth is badly you'd better select Sub Stream and the video will be more fluency.

Section3 Select the language

You can select the language you need via click on the language dropdown list to switch.

Section4 Login the camera

Click Login button and you will see the surveillance windows.

NOTE:

When setting up your camera for the first time, it will request that you modify the default username and / or password if both are still set to default. Input the new username and password, click "Modify" to complete the modification. You will now use the new username and password to login to the camera in the future.

Username

New username

New password

Security Level

Confirm the password

3.2 Setup Wizard

After logging in for the first time, you will go to "Setup Wizard" automatically. Here you can set the basic parameters of camera, such as camera name, camera time, IP configuration.

Setup Wizard

Setup Wizard - Start

Follow the guide to set your camera, click "Next" to start.

Please click the menu on the left for more settings.

Country: Select the country.

Setup Wizard

Step 1 of 4 - country

country

Please select the country where you live to ensure a better video experience for you.

Device Name: You could give name for your camera.

Setup Wizard

Step 2 of 4 - Camera Name

Camera Name

The maximum Device Name length is 20, support English, numbers, letters and symbols

System Time: Select the time zone you need to set the date, time, format and so on.

Setup Wizard

Step 3 of 4 - Camera Time

Time Zone	(GMT) Greenwich mean time; London, Lisbon, ▾
Sync with NTP server <input checked="" type="checkbox"/>	
NTP Server	Auto ▾
Device Time	2016-8-17 10:26:56 Sync with PC/Terminal
Date Format	YYYY-MM-DD ▾
Time Format	24-hour ▾
use DST <input checked="" type="checkbox"/>	
From	April ▾ first ▾ Sunday ▾ 2 ▾ : 0 0
To	October ▾ the last one ▾ Sunday ▾ 2 ▾ : 0 0
Ahead Of Time	0 ▾ Minute

IP: Set IP address of the camera. You could choose to obtain an IP automatically or set the IP address according to your needs.

Setup Wizard

Step 4 of 4 - IP Configuration

Obtain IP From DHCP

IP Address	192.168.1.4
Subnet Mask	255.255.255.0
Gateway	192.168.1.1
Primary DNS Server	192.168.8.8
Secondary DNS Server	211.162.78.2

3.3 Surveillance Window



Section1 FOSCAM Logo / LiveVideo / Settings buttons

FOSCAM : FOSCAM LOGO

LiveVideo : Path to surveillance window. Click this button and back to the surveillance window

Settings : Path to Administrator Control Panel, Click it, and it will lead to Administrator Control Panel and do advanced settings.

Section2 Multi-Device Window



The firmware inside the camera supports up to maximum of 9 cameras being monitoring at the same time. You can add other cameras in multi-camera panel.

Section3 Mode / Stream / NAA / Mirror / Flip buttons

Mode

- 1) 50Hz -----Indoor surveillance (Region: Europe, China)
- 2) 60Hz -----Indoor surveillance (Region: USA, Canada)
- 3) Outdoor Mode-----Outdoor surveillance

Stream

The default stream supports multiple modes, For example: HD Mode / 720P / 30fps / 2M meanings: Stream type / Resolution / Maximum frame rate/ Bit rate. (Different models support different specific mode.)

1) Stream type : It is used to identify the stream type.

2) 720P / VGA

There are two resolutions, the bigger one is 720P, and the smaller one (VGA) is 640x480 pixels. The bigger the resolution, the better of the image quality is. If you are accessing the camera via internet and want to get more fluent video streaming, please select resolution VGA.

3) Maximum frame rate

When the video format is 50Hz, the maximum frame rate is 25 fps. When the video format is 60Hz, the maximum frame rate is 30 fps. You should lower frame rate when the bandwidth is limited. Normally, when the frame rate above 15, you can achieve fluently video.

4) Bit rate

Generally speaking, the larger the bit rate is, the clearer video will become. But the bit rate configuration should combine well with the network bandwidth. When the bandwidth is very narrow, and bit rate is large, that will lead to video cannot play well.

You can reset the stream type on **Settings > Video > Video Settings** panel.

After changing, please re-login the camera and you can see the modification.

NAA: NAA (Network Auto-Adaptability) can make IP Camera changing the real-time rate to adapt different network conditions, which can supply better preview experience. It is OFF as default.

Section4 IR LED Lights



Click IR LED Lights and there are two modes to adjust the infrared led: Auto and Off . The default mode is Auto.

Auto: Select it and the camera will adjust the infra led (on or off) automatically.

Manual: Select it and turn off the infra led manually.

Section5 Color Adjustment

In this page, you can tune Hue, Brightness, Contrast, Saturation, and Sharpness to get higher quality.

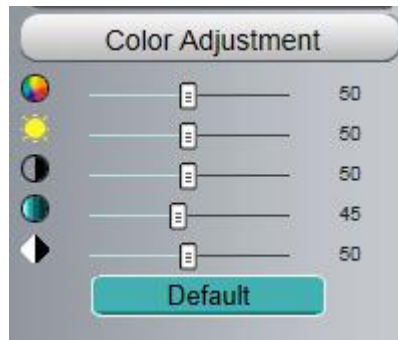

Section6 OSD

If you have added time and camera name in the video, you can see it in the live window.

Go to **Settings > Basic Settings > Camera name** panel, and you can change another device name. The default device name is anonymous.

Go to **Settings > Basic Settings > Camera time** panel and adjust the device time.

Go to **Settings > Video > On Screen Display** panel, you can add or no add OSD.

Section7 Play / Stop / Snap / Record / Full screen button

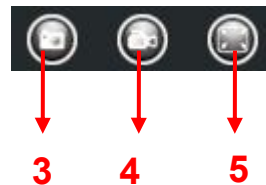
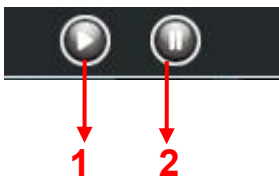

1----- Play Click it to play the video of the camera

2----- Stop Click it to stop the video of the camera

3----- Snap Click it to make snapshot and it pop up a window which picture you snapshot, right click in the window and save the picture to anywhere you want.

4----- Record Click the icon  and the camera start recording, you can see a green dot in the live window.

Click again and stop recording. The default storage path is C:\IPCamRecord. You can change the storage path: Go to **Settings > Record > Storage Location** panel.

5----- Full Screen Click it to make full-screen, or you can double click the surveillance screen to make full-screen. Double click again and exit full-screen.

Onscreen Mouse Control

Right click the mouse and you can adjust the screen ration, full screen and Zoom up.



Full Screen: Select it and Click it to make full-screen, press ESC and exit full-screen.

Zoom Up / Down: Click it and the live view will be digital zoomed up, then click Zoom Down and the live view back to original size.

NOTE:

1. This camera don't support Pan / Tilt function, so here cannot allow to use Screen PTZ.
2. For Mac OS, the plugin cannot support Onscreen Mouse function, so you cannot allow to use it.

4 Advanced Camera Settings

Click the button **Settings**, goes to Administrator Control Panel to make advanced camera settings.

4.1 Status

Status contains four columns: Device Information, Device Status, Session Status and Log, it will show you various information about your camera.

4.1.1 Device Information



The screenshot shows the 'Device Information' page. On the left is a sidebar with navigation buttons: Setup Wizard, Status, Device Information (selected), Device Status, Session Status, Log, Basic Settings, Network, Video, Detector, Record, and Firewall. The main content area is titled 'Device Information' and contains a table with the following data:

Device Information		Refresh
Camera Model	FI9853EP	
Camera Name	Anonymous	
Camera ID	A0E270F49D29	
Camera Time	2016/06/15 12:42:21	
System Firmware Version	1.5.3.16	
Application Firmware Version	2.22.2.23	
Plug-In Version	3.3.0.22	

Camera Model: The model of the device.

Camera Name: The Device Name is a unique name that you can give to your device to help you identify it. Click Basic Settings and go to Device Name panel where you can change your camera name. The default device name is anonymous.

Camera ID: Display the MAC address of your camera. For example Device ID is 008414350787, the same MAC ID sticker is found at the bottom of the camera.

Camera Time: The system time of the device. Click Basic Settings and go to Camera Time panel and adjust the time.

System Firmware Version: Display the System Firmware version of your camera.

Application Firmware Version: Display the application firmware version of your camera.

Plug-In Version: Display the plug-in version of your camera

4.1.2 Device Status

On this page you can see device status such as Alarm status, NTP/DDNS status and so on.

Device Status	
Motion alarm status	No alarm
NTP Status	Failed
DDNS Status	Disabled
UPnP Status	Disabled
IR LED Status	Off

4.1.3 Session Status

Session status will display who and which IP is visiting the camera now.

Session Status	
Username	IP Address
1	192.168.1.100

4.1.4 Log

The log record shows who and which IP address accessed or log out the camera.

NO.	Time	User	IP	Log
1	2012-09-18 02:11:45	admin	192.168.1.100	Log out
2	2012-09-18 01:48:56	admin	192.168.1.100	Log out
3	2012-09-18 01:29:51	admin	192.168.1.102	Log out
4	2012-09-18 01:27:54	admin	218.17.160.187	Log out
5	2012-09-18 01:26:21	admin	192.168.1.100	Log out
6	2012-09-18 01:25:42	admin	218.17.160.187	Login
7	2012-09-18 01:25:15	admin	192.168.1.102	Login
8	2012-09-18 01:25:13	admin	192.168.1.102	Log out
9	2012-09-18 01:24:46	admin	192.168.1.100	Login
10	2012-09-18 01:21:44	admin	192.168.1.102	Login

4.2 Basic Settings

This section allows you to configure your Camera Name, Camera Time, Mail, User Accounts and Multi-Camera.

4.2.1 Camera Name

Default alias is anonymous. You can define a name for your camera here such as apple. Click **Save** to save your changes. The alias name cannot contain special characters.



4.2.2 Camera Time

This section allows you to configure the settings of the internal system clocks for your camera.

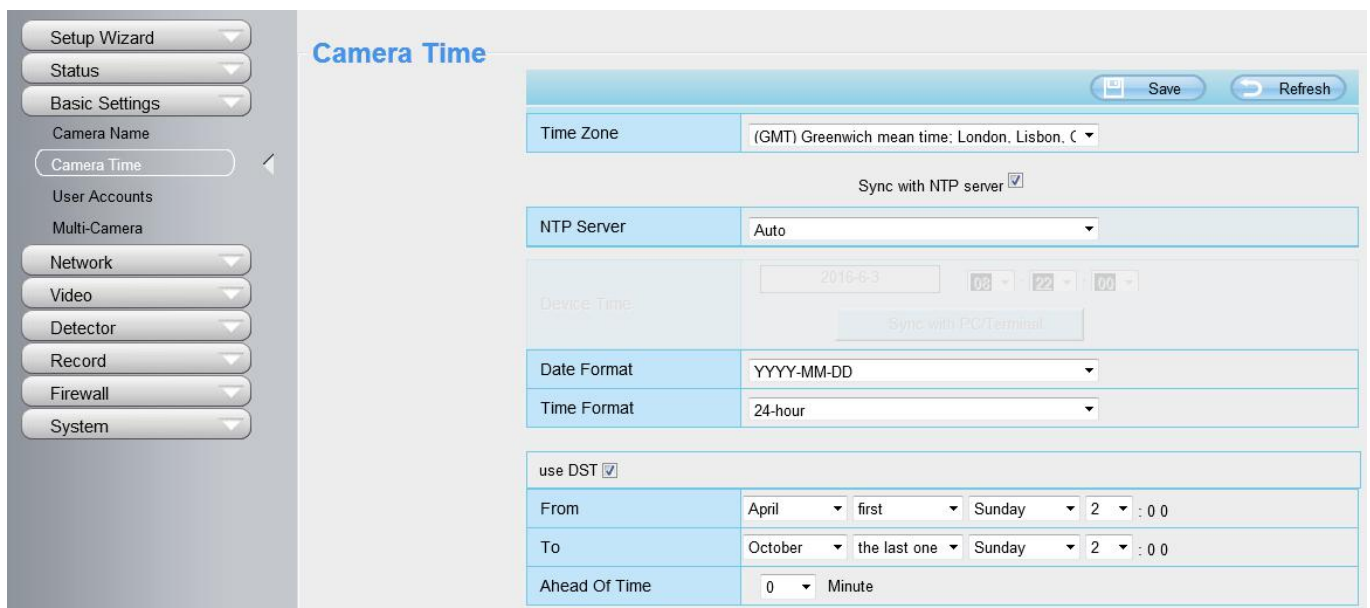

Time Zone: Select the time zone for your region from the dropdown menu.

Sync with NTP server: Network Time Protocol will synchronize your camera with an Internet time server. Choose the one that is closest to your camera.

Sync with PC: Select this option to synchronize the date and time of the Network Camera with your computer.

Manually: The administrator can enter the date and time manually. Note select the date and time format.

Use DST: Select the **use DST** (Daylight Saving Time, to set the clock ahead of the real-time), then set the start time and end time of the DST, select the daylight saving time from the drop-down menu at last.

Click **Save** button and submit your settings.

4.2.3 User Accounts

Here you can create users and set privilege, **visitor**, **operator** or **administrator**. The default administrator user accounts are admin with a blank password.

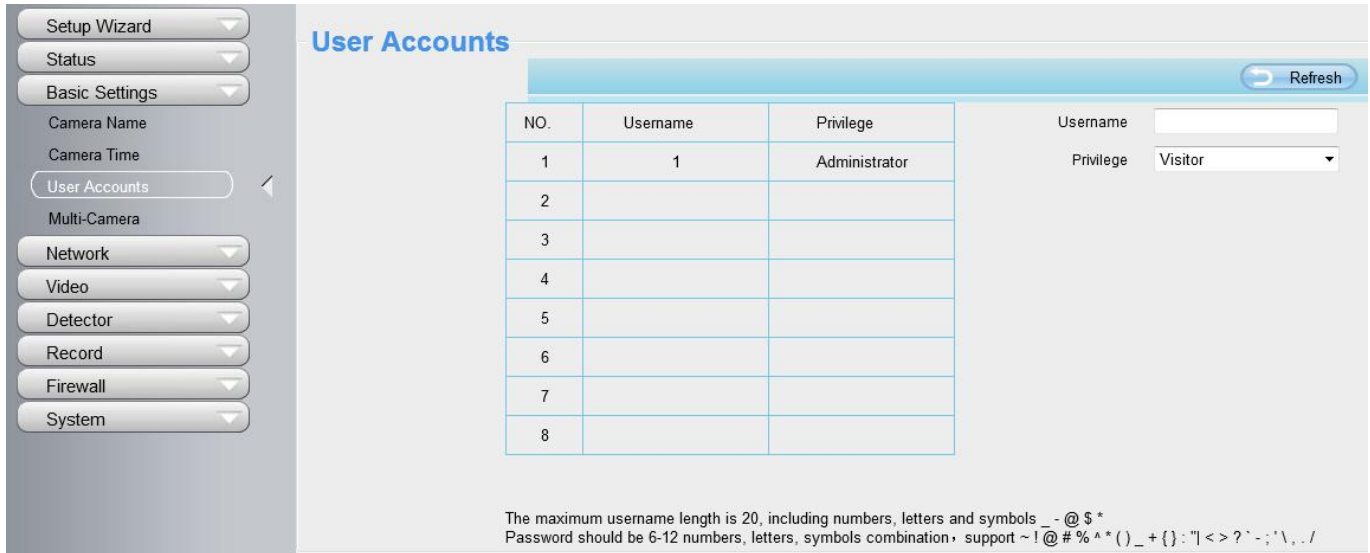

How to change the password?

Firstly, select the account which you want to change the password, then select **Change Password**, enter the old password and the new password, lastly click modify to take effect.

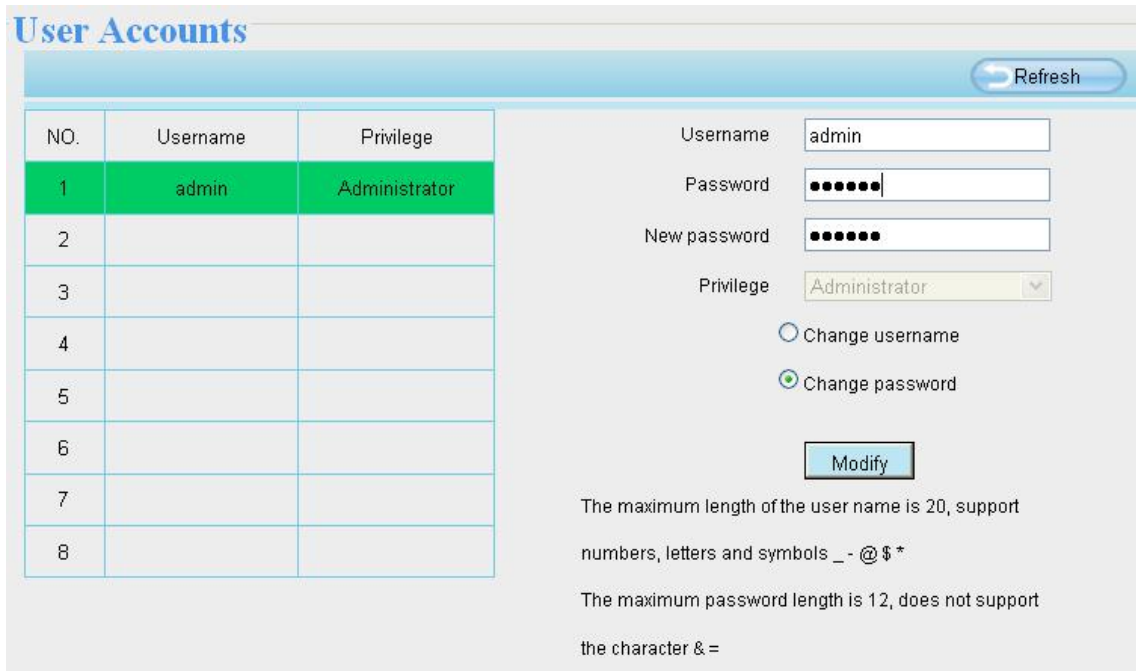

How to add account ?

Select one blank column, then enter the new user name, password and privilege, last click Add to take effect.

You can see the new added account on the Account list.

User Accounts Refresh

NO.	Username	Privilege
1	admin	Administrator
2		
3		
4		
5		
6		
7		
8		

Username:

Password:

Privilege:

Change username

Change password

The maximum length of the user name is 20, support numbers, letters and symbols _ - @\$*

The maximum password length is 12, does not support the character & =

User Accounts Refresh

NO.	Username	Privilege
1	admin	Administrator
2	operator	Operator
3		
4		
5		
6		
7		
8		

Username:

Privilege:

Change username

Change password

The maximum length of the user name is 20, support numbers, letters and symbols _ - @\$*

The maximum password length is 12, does not support the character & =

Delete: Select the account which you want to delete, then click Delete button to take effect.

NOTE: The default administrator account cannot be deleted, but you can add other administrator users.

How to change the username ?

Firstly, select the account which you want to change the username, then select **Change Username**, enter the new password, lastly click modify to take effect.

User Accounts

Refresh

NO.	Username	Privilege
1	admin	Administrator
2	operator	Operator
3		
4		
5		
6		
7		
8		

Username:

New username:

Privilege:

Change username

Change password

The maximum length of the user name is 20, support numbers, letters and symbols _ - @\$*

The maximum password length is 12, does not support the character & =

4.2.4 Multi-Camera

If you want to view multi-surveillance screens on one window, you need to login one camera, and set it as the main device, and do Multi-Device Settings, add other cameras to the first one camera. Before you do multi-cams settings, you need to assign different port such as 81, 82, 83, 84, 85, 86, 87, 88 to the cameras if there is 8 cams installed.

The firmware within the camera can support a maximum of 9 devices monitoring all at the same time. This page you can both add FOSCAM MJPEG and H.264 series cameras to the first camera and view multi-surveillance screen on one window.

- Setup Wizard
- Status
- Basic Settings
- Camera Name
- Camera Time
- User Accounts
- Multi-Camera
- Network
- Video
- Detector
- Record
- Firewall
- System

Multi-Camera

Cameras On LAN	<input type="text" value="Anonymous(192.168.1.101)"/>	Refresh
The 1st Camera	This Camera	
The 2nd Camera	None	
The 3rd Camera	None	
The 4th Camera	None	
The 5th Camera	None	
The 6th Camera	None	
The 7th Camera	None	
The 8th Camera	None	
The 9th Camera	None	

Note: If you want to access an IP Camera from the internet, make sure the camera is accessible on the internet. You

Add cameras in LAN

In Multi-Device Settings page, you can see all devices searched in LAN. The 1st Device is the default one. You can add more cameras in the list in LAN for monitoring. The camera's software supports up to 9 IP Cameras online simultaneously. Click **The 2nd Device** and click the item in the Device List in LAN, the Alias, Host and Http Port will be filled in the boxes below automatically. Enter the correct username and password then click **Add**. Add more cameras in the same way.

Cameras On LAN	FC2401P(172.16.0.195) F19821W(172.16.0.47) EH8155fjx(172.16.2.136) Foscam NVR(172.16.1.67) Foscam NVR(172.16.1.71) Foscam NVR(172.16.1.59)	1. Click it, camera model, alias, host and HTTP Port will be filled in the following boxes automatically.
	<input type="button" value="Refresh"/>	
The 1st Camera	This Camera	
The 2nd Camera	None	
Camera Model	H264	
Camera Name	F19821W	
Host	172.16.0.47	
HTTP Port	88	
Media Port	88	2 Enter the User name and password of the 2nd camera.
Username	<input type="text"/>	
Password	<input type="password"/>	
	3. Click Add to take effect. <input type="button" value="Add"/> <input type="button" value="Delete"/>	

Camera Model: Our Company produces two series cameras: MJPEG and H.264. Here will show you which series the camera belongs to.

Cameras On LAN	anonymous(192.168.11.193) F19821W for ebuyer (192.168.11.241) anonymous(192.168.11.203) anonymous(192.168.11.243)	<input type="button" value="Refresh"/> <input type="button" value="Refresh"/>
The 1st Camera	This Camera	
The 2nd Camera	F19821W(172.16.0.47)	
The 3rd Camera	F19821W for ebuyer (192.168.11.241)	
The 4th Camera	anonymous(192.168.11.203)	
The 5th Camera	None	
The 6th Camera	None	
The 7th Camera	None	
The 8th Camera	None	
The 9th Camera	None	

Note: If you want to access your camera remotely, make sure you are able to access it separately through a browser.

Back to Surveillance Windows, and click Four Windows option, you will see four cameras you added.

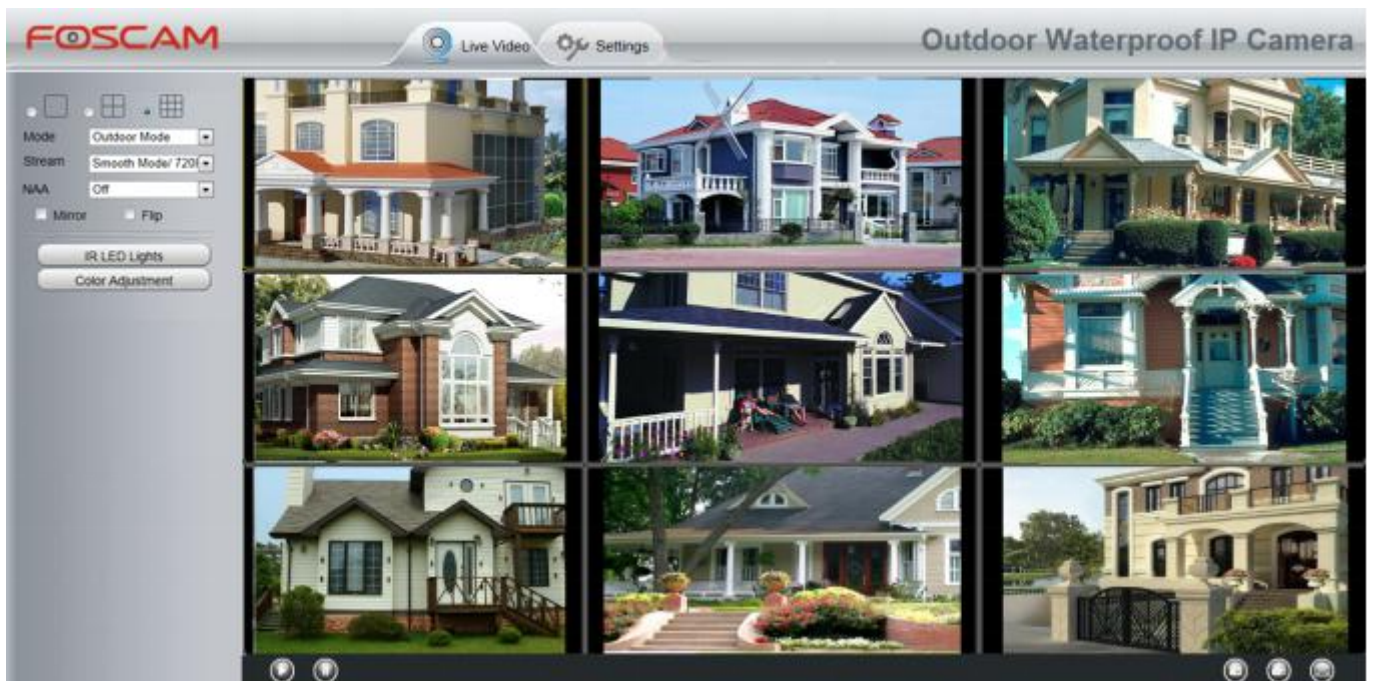
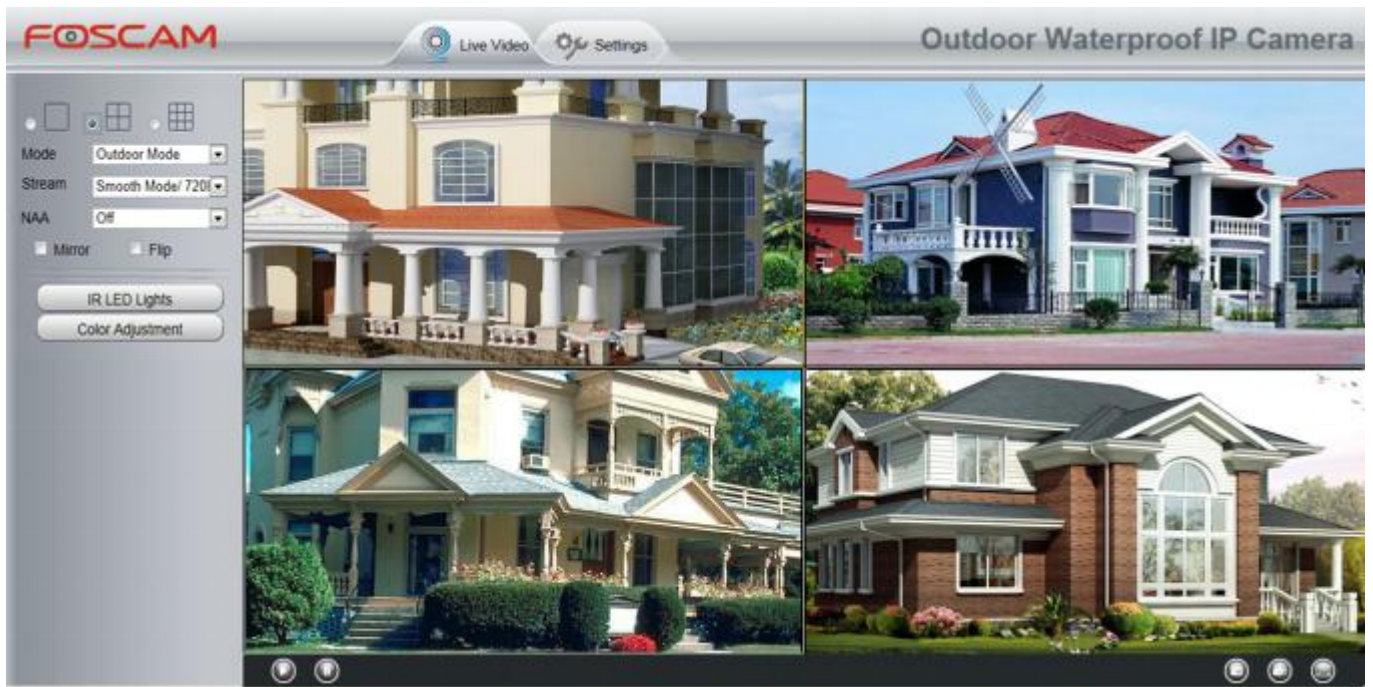

Add cameras in WAN

If you want to view all cameras via the internet(remote computer), you will need to add them using DDNS domain name. Firstly, make sure all of the cameras you added can be accessed through the internet. Login to the first camera using a DDNS domain name and port.

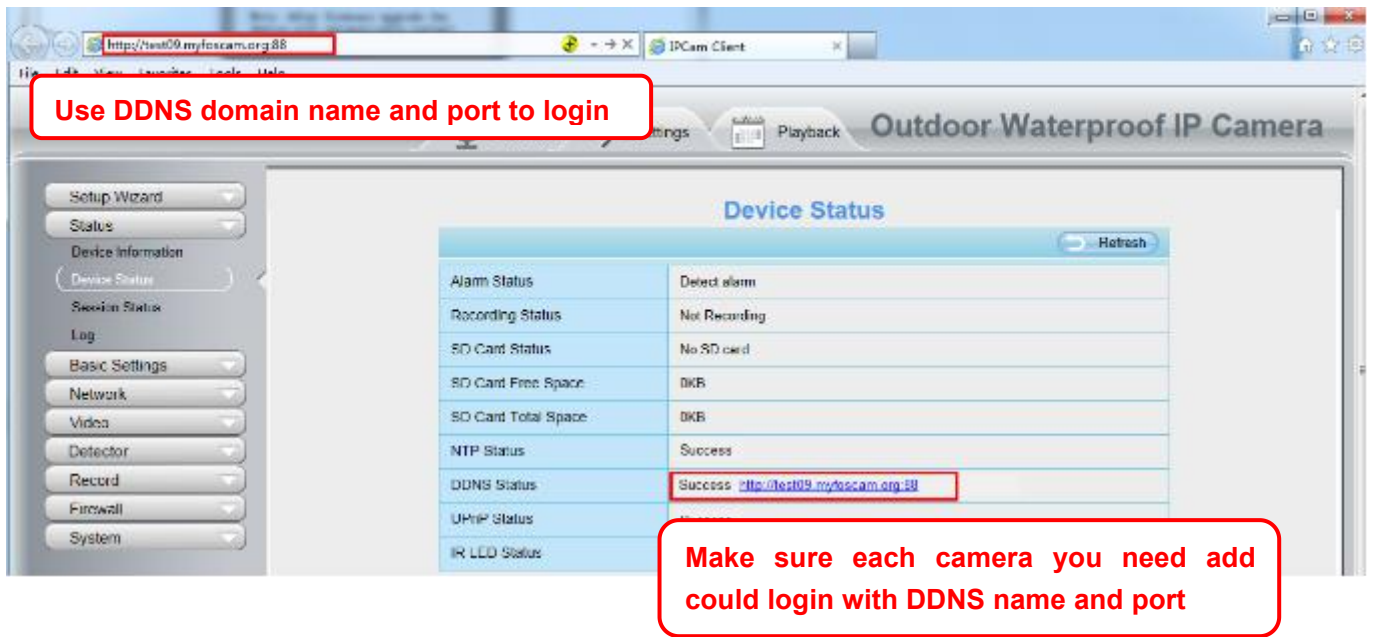

Click Multi-Device Settings. Choose The 2nd Device. Fill in the 2nd camera's name, DDNS domain name, port number. Enter user name and password and then choose Add.

The 1st Camera	This Camera
The 2nd Camera	F19821W(172.16.0.47)
Camera Model	H264 1
Camera Name	F19821W 2
Host	172.16.0.47
HTTP Port	88 3
Media Port	88
Username	admin 4
Password	
5 <input type="button" value="Add"/> <input type="button" value="Delete"/>	

1----- The camera model: MJ or H264.

2----- The 2nd camera's name

3----- Fill in the 2nd camera's DDNS host not LAN IP

NOTE: The MJ series have the same HTTP Port NO. and Media Port NO.

4----- Enter the 2nd camera's user name and password

5----- Click Add button and to take effect

NOTE: Here the Host must be entered as the second camera's DDNS domain name, not its LAN IP.

Cameras On LAN		Refresh
	anonymous(192.168.11.193) F19821W for ebuyer (192.168.11.241) anonymous(192.168.11.203) anonymous(192.168.11.243)	Refresh
The 1st Camera	This Camera	
The 2nd Camera	F19821W(172.16.0.47)	
The 3rd Camera	F19821W for ebuyer (192.168.11.241)	
The 4th Camera	anonymous(192.168.11.203)	
The 5th Camera	None	
The 6th Camera	None	
The 7th Camera	None	
The 8th Camera	None	
The 9th Camera	None	

Note: If you want to access your camera remotely, make sure you are able to access it seperately through a browser.

Return to video window. You will see all of the cameras accessible through the internet. When you are away from home, you can use the first camera's DDNS domain name and port to view all the cameras via internet.



4.3 Network

This section will allow you to configure your camera's information.

4.3.1 IP Configuration

If you want to set a static IP for the camera, please go to **IP Configuration** page. Keep the camera in the same subnet of your router or computer.

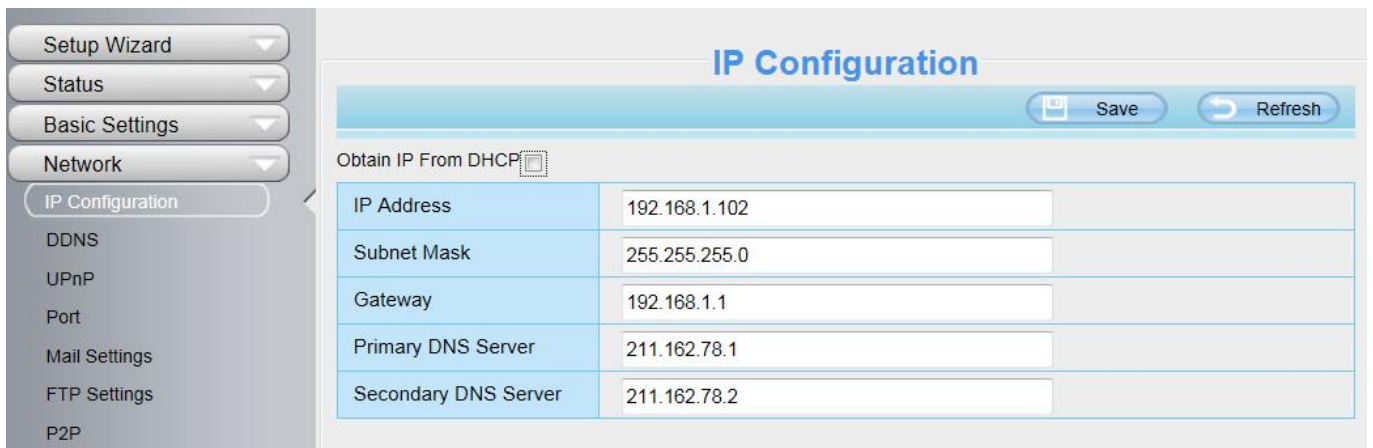

Changing settings here is the same as using the Equipment Search Tool.

It is recommended that you use the subnet mask, gateway and DNS server from your locally attached PC. If you don't know the subnet mask, gateway and DNS server, you can check your computer's local area connection as follows:

Control Panel--Network Connections--Local Area Connections --Choose Support--Details.

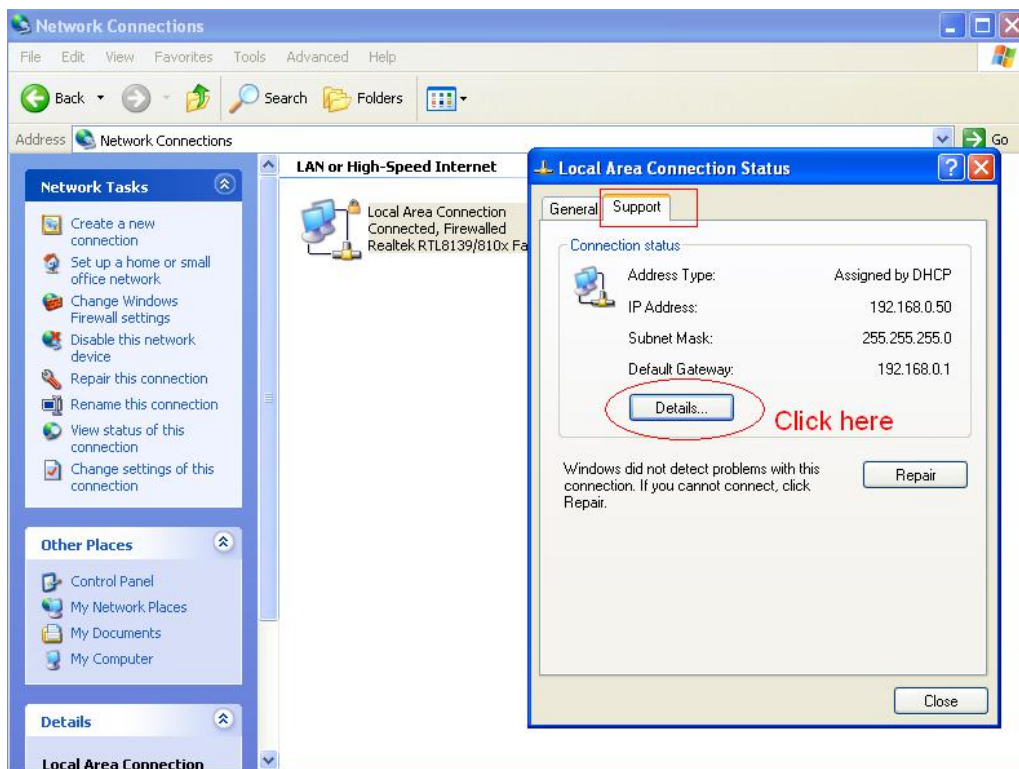

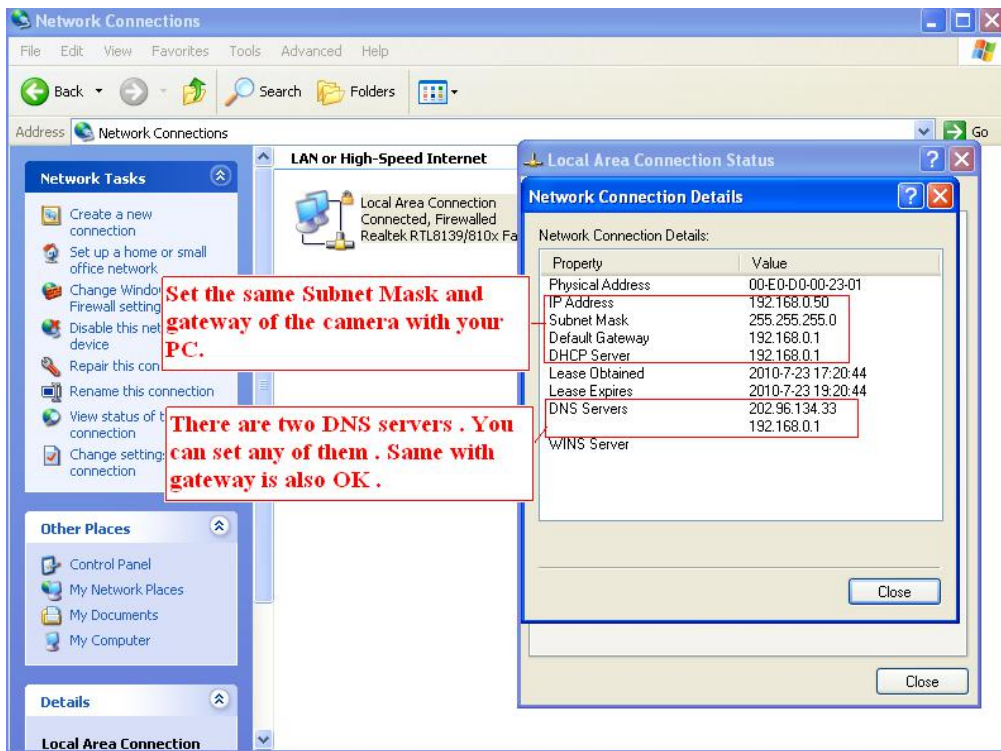

If you don't know the DNS server, you can use the same settings as the Default Gateway.

4.3.2 DDNS

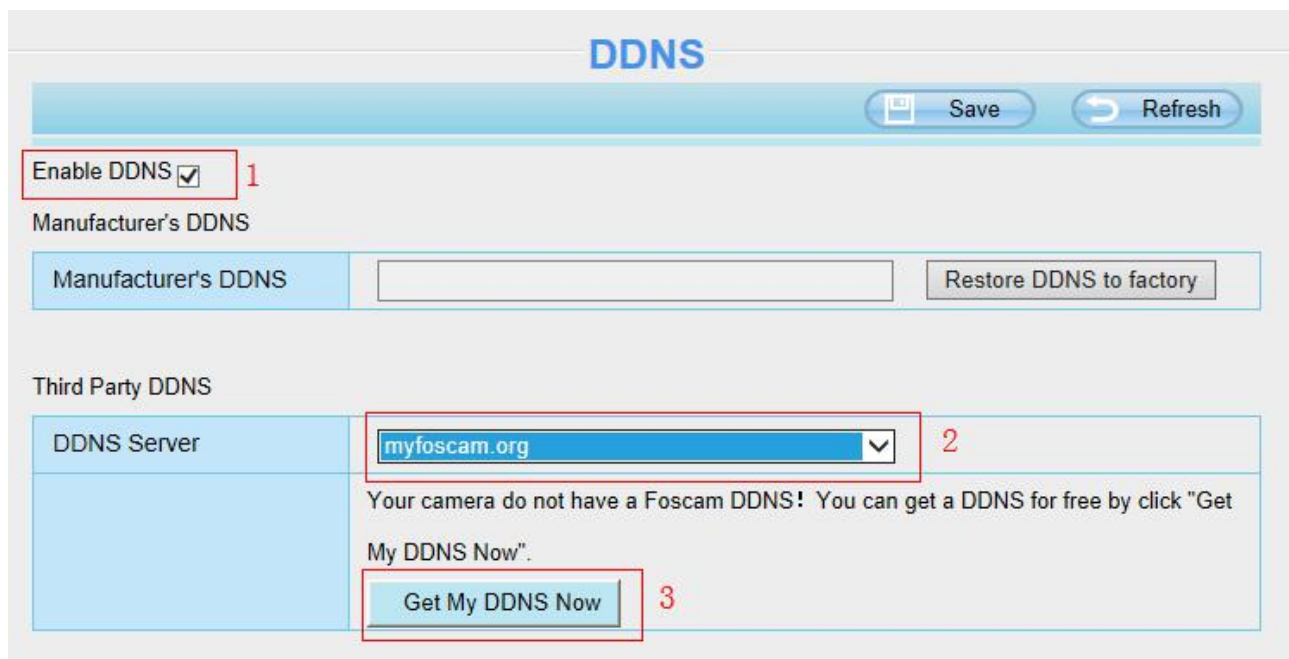

If you need Foscam DDNS, you can apply it on DDNS page.

First Enable DDNS, then select "myfoscam.org" from DDNS Server list, click "Get My DDNS Now".



Then login your Foscam Cloud account for myfoscam.org, and click "Get DDNS".

DDNS

 Save  Refresh

Please login your Foscam Cloud Account for myfoscam.org.

E-mail



Password

Get DDNS

I don't have a Foscam Account! [Tap HERE](#)

If you don't have a Foscam Cloud account, click "Tap HERE" to register one, then click "Get DDNS".

DDNS

 Save  Refresh

 Please register your Foscam Cloud Account and get myfoscam.org.

E-mail

Password

Confirm Password

Get DDNS

After get DDNS, click “Finish” to go back to DDNS settings.

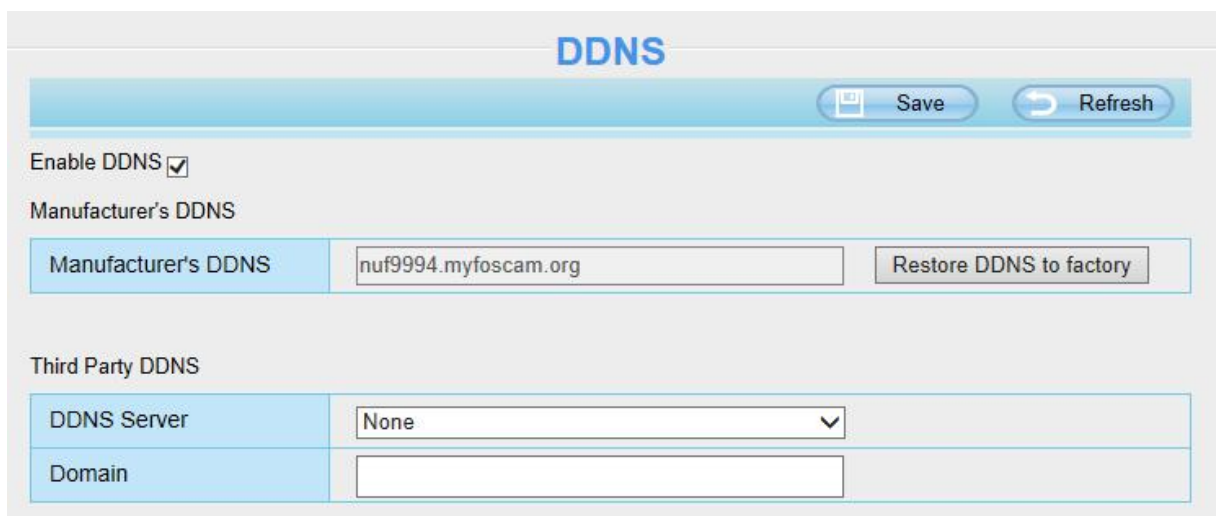
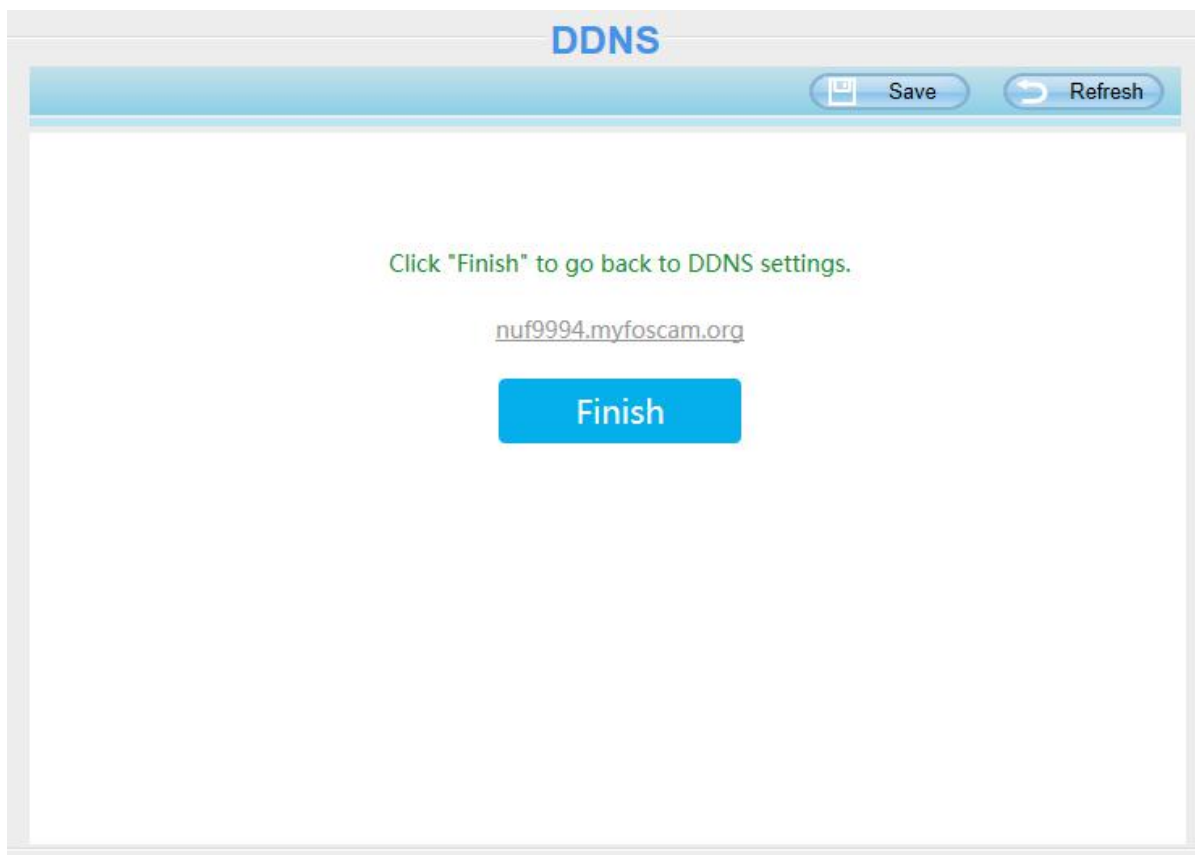

If the network error, you fail to get the DDNS, please try again.

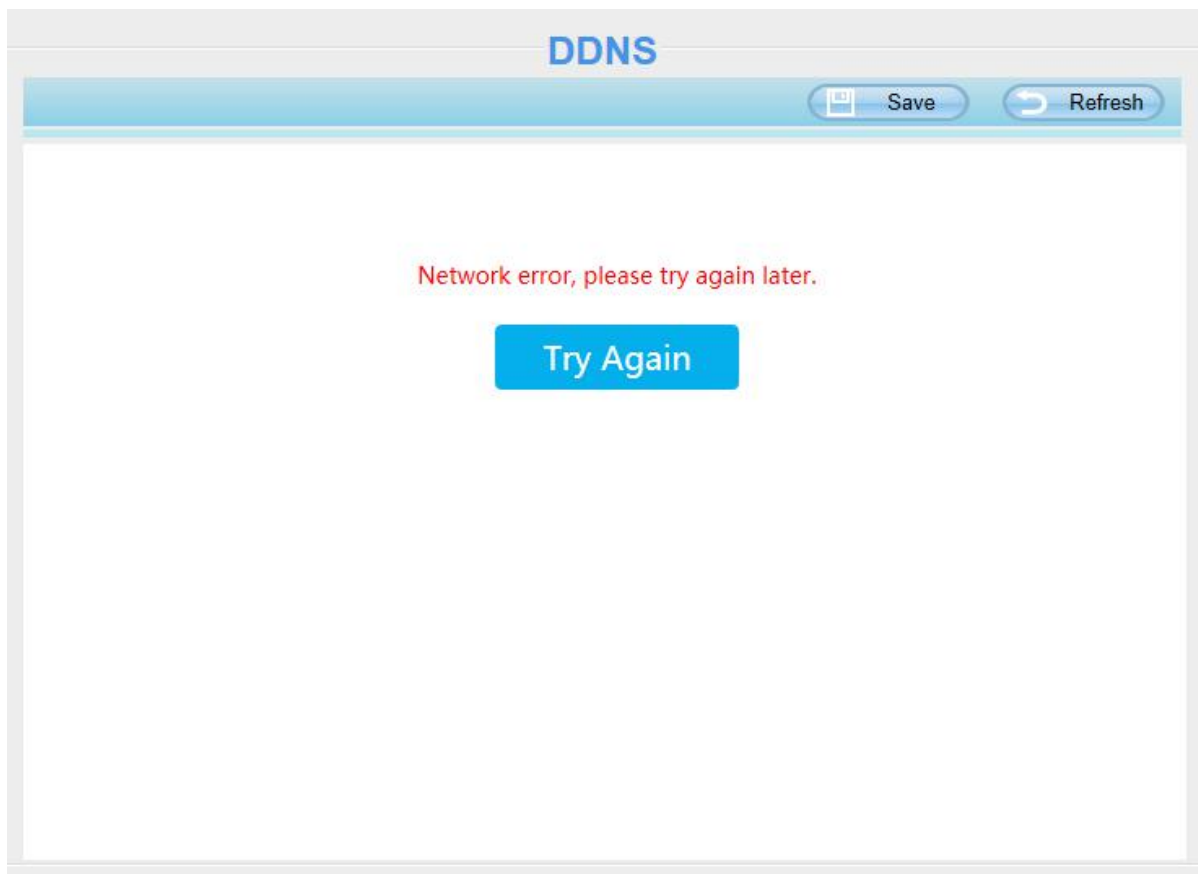

Once you success get Foscam DDNS, you can follow below step to use.

Here take **cp4911.myfoscam.org** for example. Go to option of DDNS on the **Settings > Network** panel, you can see the domain name.



Now you can use **http:// Domain name + HTTP Port** to access the camera via internet.

Take hostname **cg88891.myfoscam.org** and HTTP Port NO. 8000 for example, the accessing link of the camera via internet would be **http://cg88891.myfoscam.org:8000**

Restore DDNS to factory: If you have configured Third Party DDNS successfully, but you want to use Manufacturer's DDNS again , here click this button and start Manufacturer's DDNS Service.

Third Party Domain Name Settings

User can also use third part DDNS, such as **www.no-ip.com** , **www. 3322.com**

Here take **www.no-ip.com** for example:

1. Step 1 Go to the website www.no-ip.com to create a free hostname

Firstly: Login on www.no-ip.com and click No-IP Free to register.



Please register an account step by step according to instructions on www.no-ip.com

After registration, please login your email which used to register. You will receive an email from website, please click the link to activate your ACCOUNT as indicated in email.

Secondly: Login the link with the registered username and password to create your domain name.

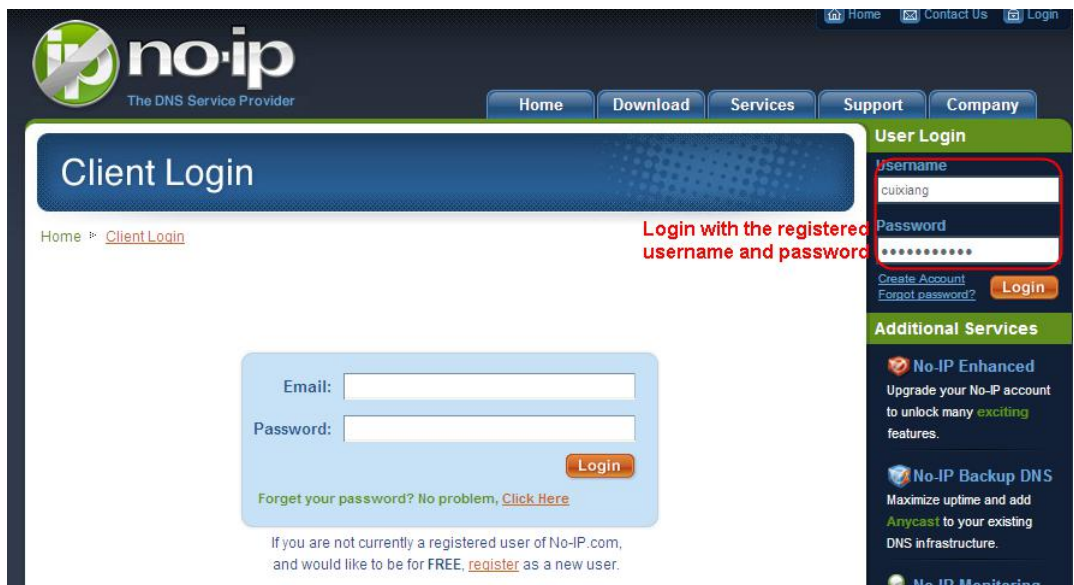

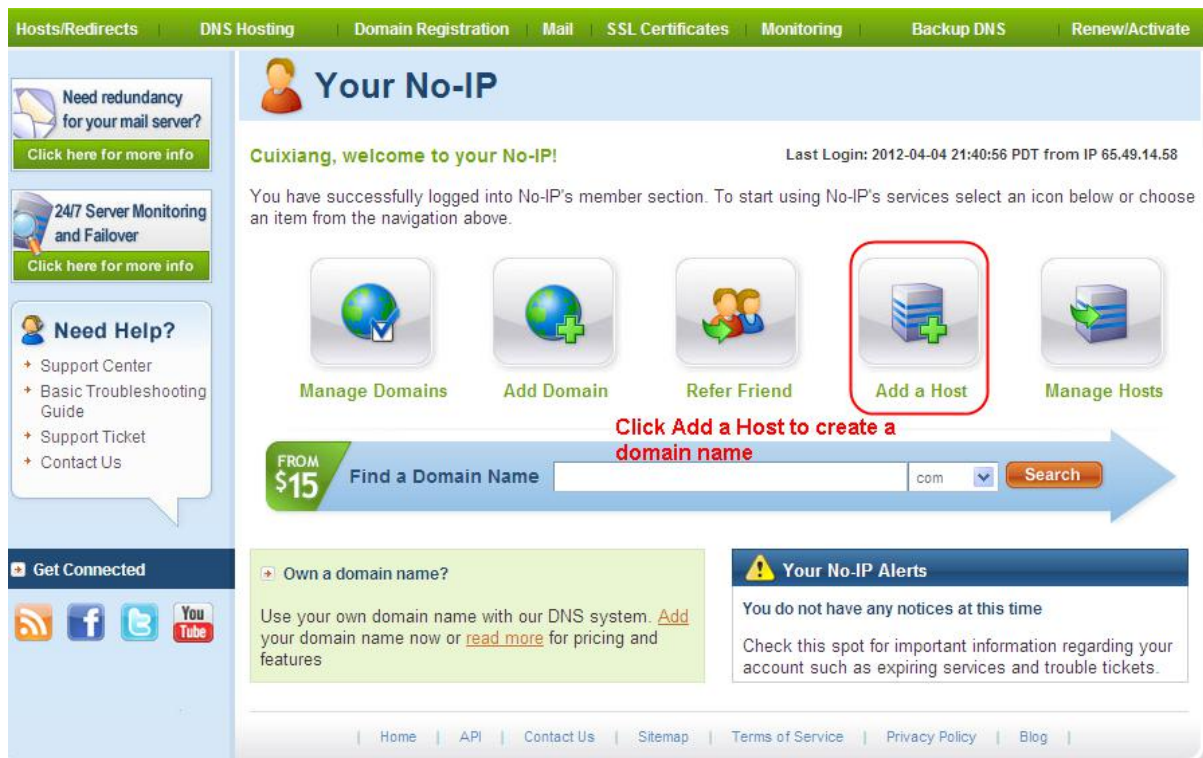

Please create the domain name step by step according to instructions on www.no-ip.com

Step 2 DO DDNS Service Settings within the Camera

Please set DDNS Settings within the camera by hostname, a user name and password you've got from www.no-ip.com

Take hostname `ycxgwp.no-ip.info`, user name **foscam**, password **foscam2012** for example.

Firstly, goes to option of DDNS Settings on the administrator panel.

Secondly, select No-IP as a server.

Thirdly, fill `foscam` as DDNS user, fill password `foscam2012` as DDNS password, fill `ycxgwp.no-ip.info` as DDNS domain and server URL, Then click save to make effect. The camera will restart and to take the DDNS settings effective.

Fourthly, after the restart, login the camera, and go to option of Device Status on the administrator panel, and check if the DDNS status is successful.

If failed, please double check if you have input the correct hostname, user name, and password, and try to redo the settings.

NOTE:

If you have set Third Party DDNS successfully, the Foscam Domain Name will be invalid. The Third Party DDNS and the Foscam Domain Name cannot work at the same time, the last time you configured will take effect.

2. Do port forwarding within the router

Example: The camera's LAN IP address is <http://192.168.8.100:2000>

Firstly, login the router, goes to the menu of Port Forwarding or Port Trigger (or named Virtue Server on some brands of router). Take Linksys brand router as an example, Login the router, and goes to **Applications & Gaming > Single Port Forwarding**.

Secondly, Create a new column by LAN IP address & HTTP Port No. of the camera within the router showed as below.

Single Port Forwarding

Application Name	External Port	Internal Port	Protocol	To IP Address	Enabled
None	---	---	---	192.168.8.	<input type="checkbox"/>
None	---	---	---	192.168.8.	<input type="checkbox"/>
None	---	---	---	192.168.8.	<input type="checkbox"/>
None	---	---	---	192.168.8.	<input type="checkbox"/>
None	---	---	---	192.168.8.	<input type="checkbox"/>
Http	2000	2000	Both	192.168.8.100	<input checked="" type="checkbox"/>
Media	9200	9200	Both	192.168.8.100	<input checked="" type="checkbox"/>

3. Use domain name to access the camera via internet

After the port forwarding is finished, you can use the **domain name+ http no.** to access the camera via internet. Take hostname `ycxgwp.no-ip.info` and http no. 2000 for example, the accessing link of the camera via internet would be `http:// ycxgwp.no-ip.info:2000`

4.3.3 UPnP

UPnP

Save Refresh

Enable UPnP No

The default UPnP status is closed. You can enable UPnP, then the camera's software will be configured for port forwarding. Back to the **Device Status** panel, you can see the UPnP status:

Device Status	
Alarm Status	Disabled
NTP Status	Disable
DDNS Status	Success http://aa2022.myfoscam.org:8000
UPnP Status	Success
IR LED Status	Off

The camera's software will be configured for port forwarding. There may be issues with your routers security settings, and sometimes may error. We recommend you configure port forwarding manually on your router.

4.3.4 Port

This camera supports HTTP Port / HTTPS Port/ ONVIF Port. HTTP Port is used to access the camera remotely.

HTTP port: By default, the HTTP is set to 88. Also, they can be assigned with another port number between 1 and 65535. But make sure they can not be conflict with other existing ports like 25, 21.

Port	
HTTP Port	88
HTTPS Port	443
ONVIF Port	888

Another way to change the HTTP port NO.

Step 1: Open the Equipment Search Tool, select the camera you would like to change the port of, right click on the IP address, and click on "Network Configuration", this brings up the network configuration box as shown in flowing figures.

Camera Name	IP Address	Device ID	Type
Anonymous		0626E589230	H. 264

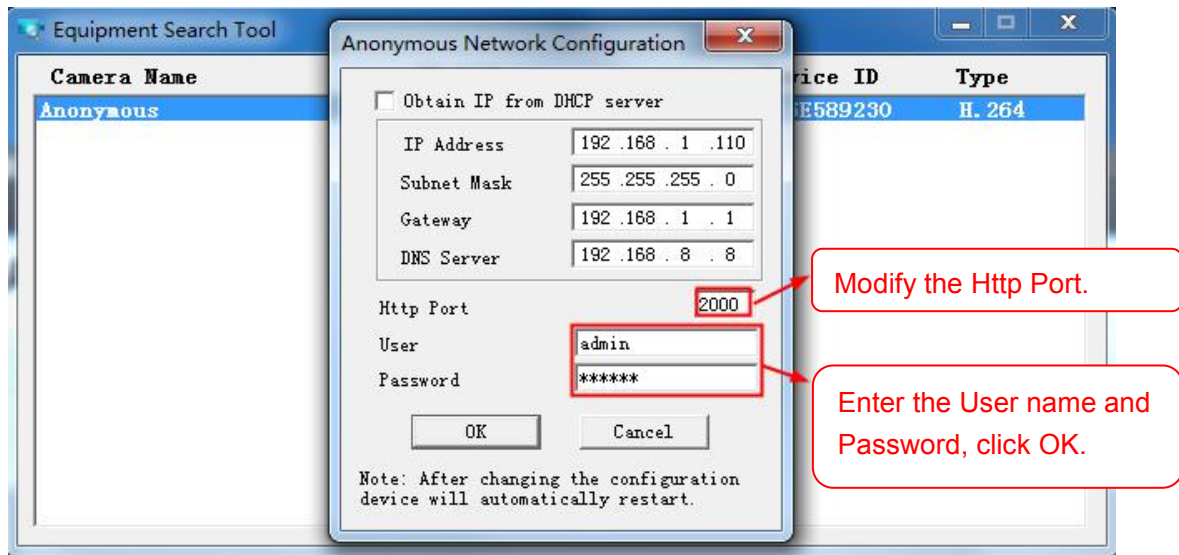

Step 2: Enter the username and password of the Administrator (default username is admin with a blank password), and click **OK** to apply changes.

Step 3: Wait around 10 seconds, you'll see that the camera's LAN IP address has changed. In our example it was changed to 2000, so we see `http://192.168.8.102:2000` in Equipment Search Tool. Also, the LAN IP address is now fixed at a static IP address of `http://192.168.8.102:2000`. This IP address will not change even if the camera is powered off and back on, the camera will remain on this LAN IP address. This is very important that a static LAN IP address is set, or you may have problems later with remote access and seeing the camera remotely if the camera loses power and reconnects on a different LAN IP address. Make sure you set a static LAN IP address!

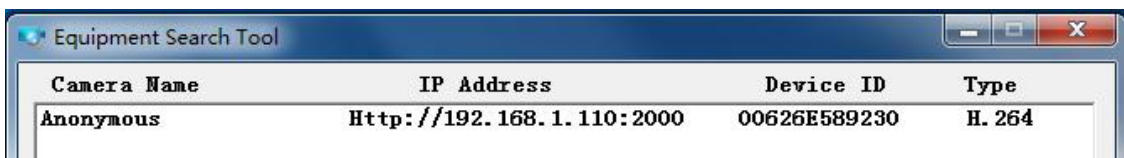

If the camera cannot be accessed, please make sure the port forwarding is succeed.

ONVIF port: By default, the ONVIF port is set to 888. Also, they can be assigned with another port number between 1 and 65535(except 0 and 65534). But make sure they can not be conflict with other existing ports.

HTTPS Port: The default port is 443. You can use the url to access the camera: **https:// IP + HTTPS port.**

4.3.5 Mail Settings

If you want the camera to send emails when motion has been detected, here Mail will need to be configured.

5 <input type="button" value="Save"/> <input type="button" value="Refresh"/>	
Enable <input checked="" type="checkbox"/>	
SMTP Server	smtp.gmail.com SMTP server address supports English, numbers and @ _ . -
SMTP Port	25 1
Transport Layer Security	STARTTLS G-Mail only supports TLS at Port 465 and STARTTLS at Port 587 or 25. Hotmail only supports STARTTLS at Port 587 or 25.
Need Authentication	Yes 2
SMTP Username	test123@gmai.com The maximum length of the user name is 63, support numbers, letters and symbols @ _ . \$ * -
SMTP Password The maximum password length is 32, does not support the character & =
Sender E-mail	test123@gmai.com 3 <input type="button" value="Test"/> 6
First Receiver	test@163.com The maximum length of the receiver is 63, support numbers, letters and symbols @ _ . \$ * -
Second Receiver	tset@hotmail.com 4
Third Receiver	
Fourth Receiver	

1----- SMTP Server/ Port /Transport Layer Security Enter SMTP server for sender. SMTP port is usually set as 25. Some SMTP servers have their own port, such as 587 or 465, and Transport Layer Security usually is None. If you use Gmail, Transport Layer Security must be set to TLS or STARTTLS and SMTP Port must be set to 465 or 25 or 587, which port you choose should be decided by which Transport Layer Security you select.

2----- SMTP Username/ password ID account and password of the sender email address

3----- Sender E-mail Mailbox for sender must support SMTP

4----- Receiver Mailbox for receiver need not support SMTP, you can set 4 receivers

5----- Save Click Save to take effect

6----- Test Click Test to see if Mail has been successfully configured.

Click **Test** to see if Mail has been successfully configured.

Save Refresh	
Enable <input checked="" type="checkbox"/>	
SMTP Server	smtp.gmail.com SMTP server address supports English, numbers and @ _ . -
SMTP Port	25
Transport Layer Security	STARTTLS G-Mail only supports TLS at Port 465 and STARTTLS at Port 587 or 25. Hotmail only supports STARTTLS at Port 587 or 25.
Need Authentication	Yes
SMTP Username	test123@gmai.com The maximum length of the user name is 63, support numbers, letters and symbols @ _ . \$ * -
SMTP Password The maximum password length is 32, does not support the character & =
Sender E-mail	test123@gmai.com <input type="button" value="Test"/> Success Test result.
First Receiver	test@163.com The maximum length of the receiver is 63, support numbers, letters and symbols @ _ . \$ * -
Second Receiver	tset@hotmail.com
Third Receiver	
Fourth Receiver	

If the test success, you can see the Success behind the Test, at the same time the receivers will receive a test mail.

If the test fails with one of the following errors after clicking Test, verify that the information you entered is correct and again select Test .

- 1) Cannot connect to the server
- 2) Network Error. Please try later
- 3) Server Error
- 4) Incorrect user or password
- 5) The sender is denied by the server. Maybe the server need to authenticate the user, please check it and try again
- 6) The receiver is denied by the server. Maybe because of the anti-spam privacy of the server
- 7) The message is denied by the server. Maybe because of the anti-spam privacy of the server
- 8) The server does not support the authentication mode used by the device

4.3.6 FTP Settings

If you want to upload record images to your FTP server, you can set **FTP Settings**.

Save Refresh	
FTP Server	<input type="text" value="ftp://192.168.8.150"/> Example:ftp://192.168.1.103/dir The maximum length of the address is 127, does not support the character & =
Port	<input type="text" value="21"/>
FTP Mode	PORT
Username	<input type="text" value="yaocuxiang"/> The maximum length of the user name is 63, support numbers, letters and symbols _ @ \$ * - . # !
Password	<input type="password" value="....."/> The maximum password length is 63, does not support the character & =
Test	Success

Figure a

Save Refresh	
FTP server	<input type="text" value="ftp://ftp.mgenseal.com"/> example:ftp://192.168.1.103
Port	<input type="text" value="21"/>
FTP Mode	PORT
User name	<input type="text" value="deotestge"/>
Password	<input type="password" value="....."/>
Test	Success

Figure b

FTP server: If your FTP server is located on the LAN, you can set as Figure a.

If you have an FTP server which you can access on the internet, you can set as Figure b.

Port: Default is port 21. If changed, external FTP client program must change the server connection port accordingly.

FTP Mode: Here supports two modes: PORT and PASV.

Username / password: The FTP account and password.

Click **Save** to take effect.

Click **Test** to see if FTP has been successfully configured.

4.3.7 P2P

Access the camera by smart phone (Android or iOS operating system)

First of all, you need to open the P2P function of the camera at **Settings > Network > P2P**.

4.3.8 Onvif

On this page, you can enable the Onvif port and RTSP port. ONVIF(Open Network Video Interface Forum) is a standard for talking to Network Camera Devices and other similar security hardware.

ONVIF port: By default, the ONVIF port is set to 888. Also, they can be assigned with another port number between 1 and 65535(except 0 and 65534). But make sure they can not be conflict with other existing ports.

RTSP port: The default port is 554.

4.4 Video

This section allows you to configure Video stream settings, On screen display and Snapshot settings.

4.4.1 Video Settings

There are two ways to set the stream video settings. They are main stream video settings and sub stream video settings.

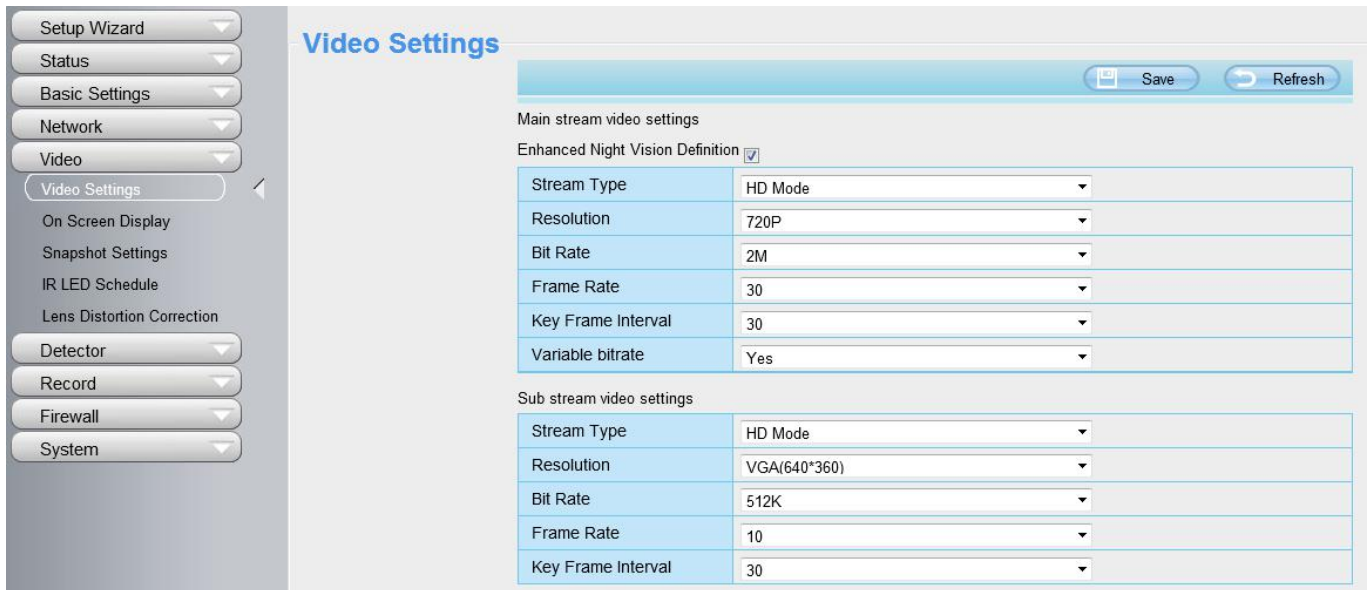

Enhanced Night video Definition: The camera will automatically drop the frame to extend the recording time in the night.

Stream type: There are four types to identify different streams you have set.

Resolution: The camera supports two types: 720P, VGA. The higher the resolution is, the clearer video will become. But the code flux will become larger too, and it will take up more bandwidth.

Bit Rate: Generally speaking, the larger the bit rate is, the clearer video will become. But the bit rate configuration should combine well with the network bandwidth. When the bandwidth is very narrow, and bit rate is large, that will lead to video can not play well.

Frame Rate: Note that a larger frame size takes up more bandwidth. When the video format is 50Hz, the maximum frame rate is 25 fps. When the video format is 60Hz, the maximum frame rate is 30 fps. You should lower frame rate when the bandwidth is limited. Normally, when the frame rate above 15, you can achieve fluently video.

Key Frame Interval: The time between last key frame and next key frame. The shorter the duration, the more likely you will get a better video quality, but at the cost of higher network bandwidth consumption.

Variable Bitrate: Select the Bit rate type to constant or variable. If select Yes, the camera will change the video bit rate according to the situation, but will not more than the maximum parameter "Bit Rate"; If select No, the Bit Rate is unchanged.

4.4.2 On Screen Display

This page is used to add timestamp and device name on the video.

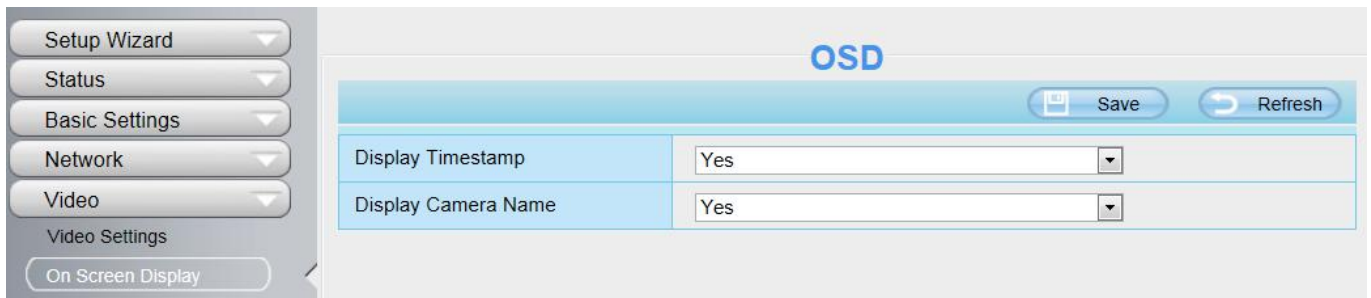

Display Timestamp: There are two options: Yes or NO. Select Yes and you can see the system date on the video,

Display Camera Name: There are two options: Yes or NO. Select Yes and you can see the device name on the video.

4.4.3 Snapshot Settings

On this page you can set the snapshot pictures' image quality and the storage path.

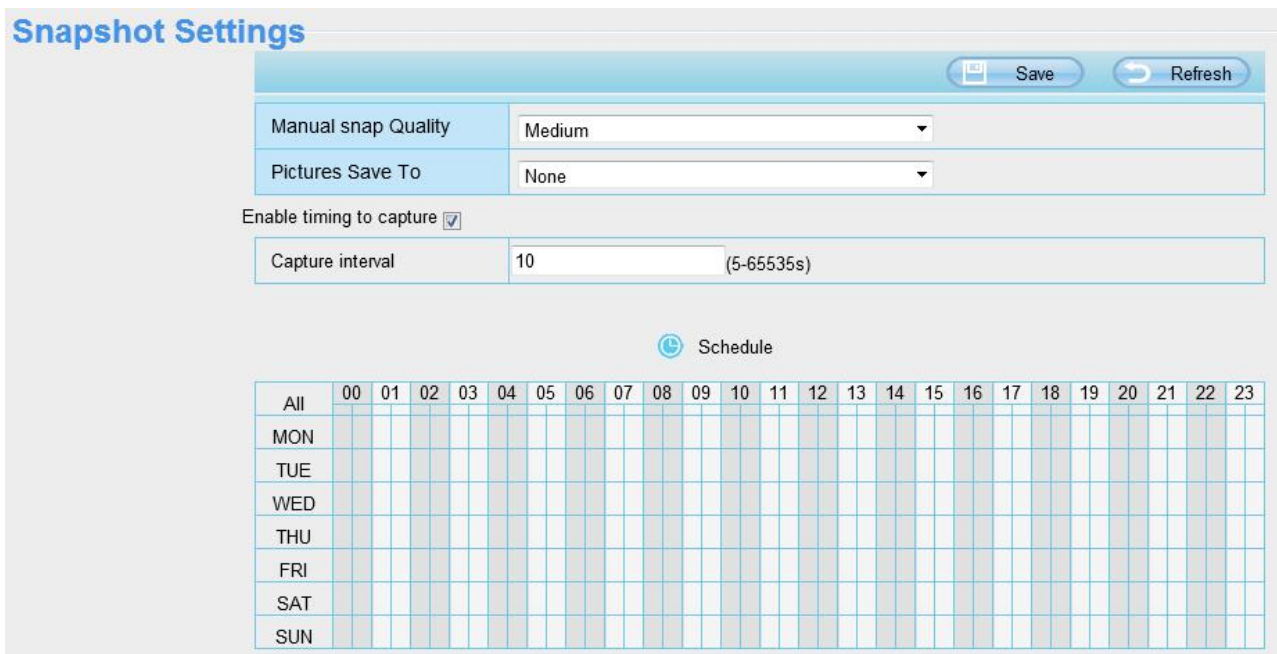

Manual Snap Quality: Low, Middle and High. The higher the quality, the picture will be clearer.

Pictures Save To: FTP. If you have done FTP and Alarm settings, when alarming, the camera will snap pictures to the FTP automatically. If you select the FTP, you can set the file name which the picture save to.

Enable Timing to Capture

To enable capture interval, follow the steps below:

1 Select Enable timing to capture

2 Capture interval: The interval time between two captures.

3 Select the capture time

- Capture anytime

Click the black button up the MON, you will see all time range turn red. When something moving in the detection area at anytime, the camera will capture.

- Specify an capture schedule

Click the week day words, the corresponding column will be selected. For example, click TUE, the all column of TUE turns to red, that means during Tuesday whole day, the camera will capture.

- Press the left mouse and drag it on the time boxes, you can select the serial area,

4 Click **Save** button to take effect.

4.4.4 IR LED Schedule

You can set the period of time during which the infrared lamp is turned off to prevent your baby from being influenced during sleep. You can also turn off the infrared lamp on the video preview page at any time.

IR LED Schedule

Turn the IR LED off

From 08:00 To 18:00

Add

4.5 Detector

Motion Detection

IP Camera supports **Motion Detection Alarm**, when the motion has been detected, it will send emails or upload images to FTP.

Motion Detection

Save Refresh

Enable 1

Sensitivity Medium 2

Triggered Interval 10s 3

Action

PC Sound

Send E-mail

Take Snapshot Time Interval 2s 4

Please set the capture storage location in advance.(Video -> Snapshot Settings)

Recording

Please set the video storage location in advance.(Record -> Storage Location)

Push message to the phone

Set Detection Area 5

Schedule 6

All 00 01 02 03 04 05 06 07 08 09 10 11 12 13 14 15 16 17 18 19 20 21 22 23

To enable motion detection, follow the steps below:

1 Enable Motion Detection

2 Sensitivity---- It supports three modes: Low, Middle and High. The higher the sensitivity, the camera will be more easily alarmed. Select one motion sensitivity.

3 Trigger interval--- The interval time between two motion detections. Here supports 5s/6s/7s/8s/9s/10s/11s/12s/13s/14s/15s. Select one interval time.

4 Select the alarm indicators

There are some alarm indicators:

A PC Sound

If you select PC Sound, when the motion has been detected, the people around the PC will hear beep alarm sound.

B Send E-mail

If you want to receive alarm emails when motion is detected, you must select Send E-mail and set Mail Settings first.

C Take Snapshot

If you select this checkbox, when the motion has been detected, the camera will snap the live view window as a still picture and load it to the FTP. Make sure you have set the storage path in **Video > Snapshot Settings** panel.

Time interval: The interval time between two pictures.

D Recording

If you select this checkbox, when the motion has been detected, the camera will recording and load it to the FTP server. Make sure you have set FTP and set FTP as the storage path in Video->Snapshot settings panel.

E Push message to the phone

If you select this checkbox, when the motion has been detected, the camera will push the message to the phone which has been connected the camera.

5 Set Detection Area

Click set Detection Area and it pop up a window, then you can draw the detection area. Click **OK** button after settings. When something moving in the detection area, the camera will alarm.

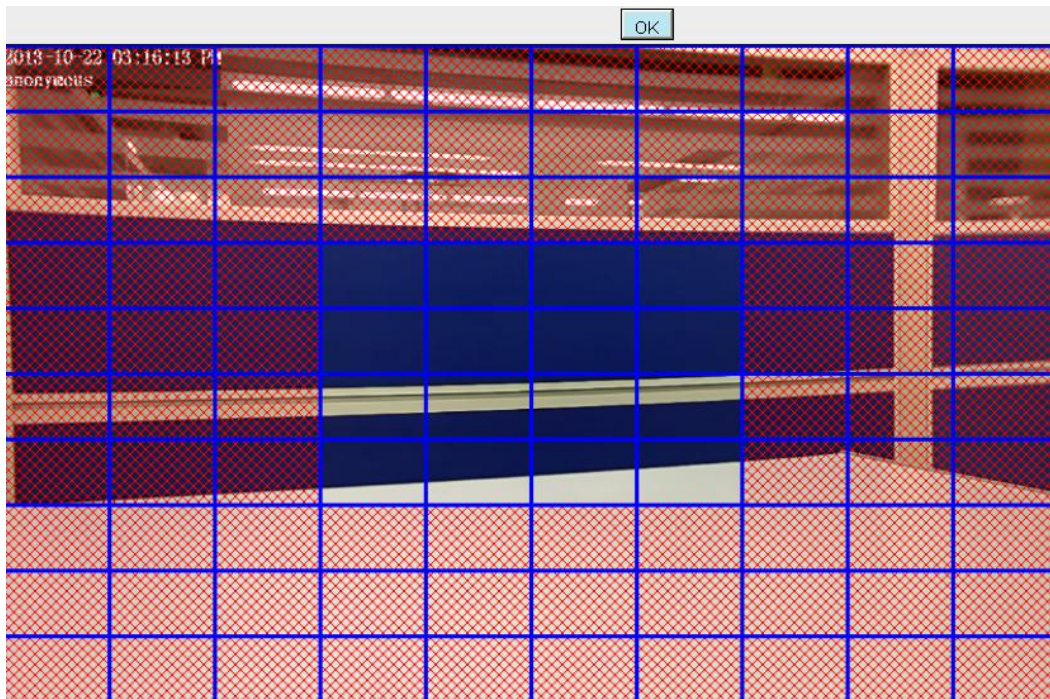

6 Alarm Schedule

1. Alarm anytime when motion is detected

Click the black button up the MON, you will see all time range turn red. When something moving in the detection area at anytime, the camera will alarm.

Set Detection Area

	00	01	02	03	04	05	06	07	08	09	10	11	12	13	14	15	16	17	18	19	20	21	22	23
All																								
MON																								
TUE																								
WED																								
THU																								
FRI																								
SAT																								
SUN																								

2. Specify an alarm schedule

Click the week day words, the corresponding column will be selected. For example, click TUE, the all column of TUE turns to red, that means during Tuesday whole day, when something moving in the detection area, the camera will alarm.

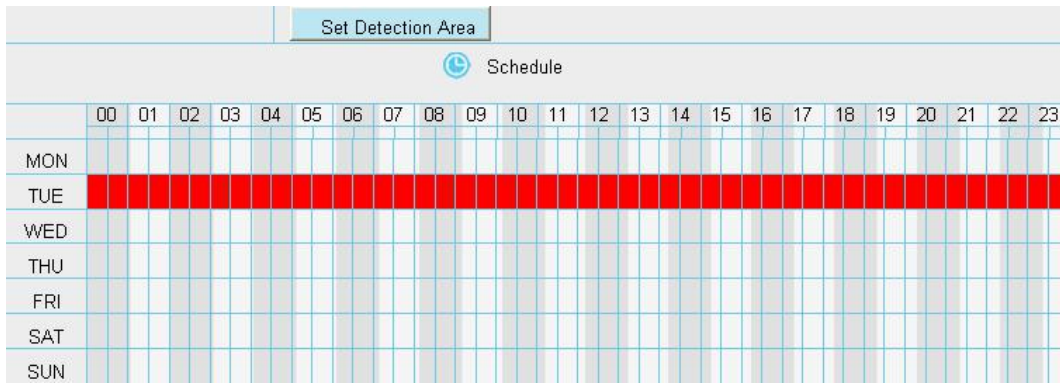

3. Press the left mouse and drag it on the time boxes, you can select the serial area,

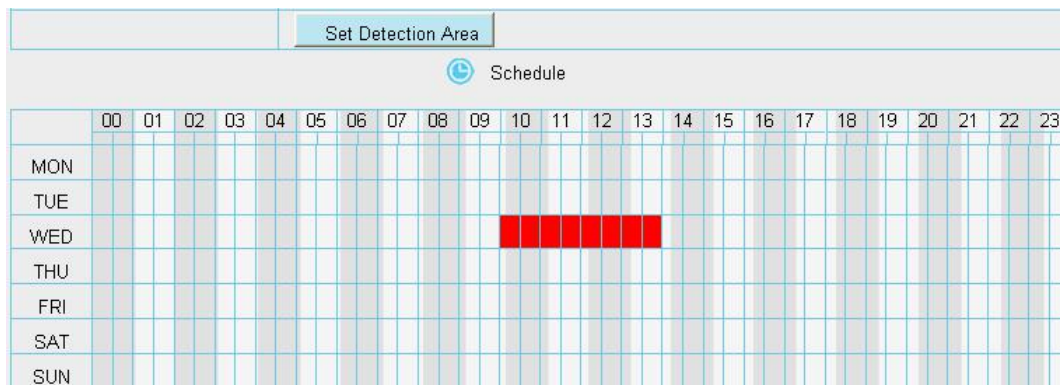

7 Click Save button to take effect. When the motion is detected during the detection time in the detection area, the camera will alarm and adopt the corresponding alarm indicators.

NOTE: You must set the detection area and detection schedule, or else there is no alarm anywhere and anytime.

4.6 Record

4.6.1 Storage Location

On this page you can change the manually recording storage path, the default storage path is c:\IPCcamRecord.

Enter the local folder: Click here, You can enter the local storage folder.

4.6.2 Alarm Recording

On this page you can configure the alarm recording time and pre-recorded time.

Setup Wizard
Status
Basic Settings
Network
Video
Detector
Record
Storage Location
Alarm Recording
Local Alarm Recording

Alarm Recording

Save Refresh

Enable Pre-Record

Pre-recorded Time 5s

Alarm Recording Time 30s

4.6.3 Local Alarm Recording

On this page you can enable local alarm record, and select the local alarm record time.

Setup Wizard
Status
Basic Settings
Network
Video
Detector
Record
Storage Location
Alarm Recording
Local Alarm Recording
Scheduled Recording

Local Alarm Recording

Save Refresh

Enable Local Alarm Recording

Local Alarm Recording Time 30s

4.6.4 Schedule Recording

On the page you can configure the schedule record.

Note: Schedule Recording only supports FTP server.

Setup Wizard
Status
Basic Settings
Network
Video
Detector
Record
Storage Location
Alarm Recording
Local Alarm Recording
Scheduled Recording
Firewall
System

Scheduled Recording

Save Refresh

Enable Scheduled Recording

Enable longtime recording Yes

Record full strategy Cover

Auto Record Yes

Stream Main stream

Edit Scheduled Recording

	All	00	01	02	03	04	05	06	07
MON		08	09	10	11	12	13	14	15
TUE		16	17	18	19	20	21	22	23
WED									
THU									
FRI									
SAT									
SUN									

Click **Save** button to take effect.

4.7 Firewall

This section explains how to control the access permission by checking the client PC's IP addresses. It is composed of the following columns: Block access from these IP addresses and Only allow access from these IP addresses.

IP Address #1	
IP Address #2	
IP Address #3	
IP Address #4	
IP Address #5	
IP Address #6	
IP Address #7	
IP Address #8	

Enable firewall, If you select Only allow access from these IP addresses and fill in 8 IP addresses at most, only those clients whose IP addresses listed in the Only allow access from these IP addresses can access the Network Camera. If you select Block access from these IP addresses, only those clients whose IP addresses are in the IP list cannot access the Network Camera.

Click **Save** to take effect.

4.8 System

In this panel, you can back up/restore your camera settings, upgrade the firmware to the latest version, restore the camera to default settings and reboot the device.

4.8.1 Back-up & Restore

Click Backup to save all the parameters you have set. These parameters will be stored in a bin file for future use.

Click Browse and select the parameters file you have stored, then click Submit to restore the restore the parameters.

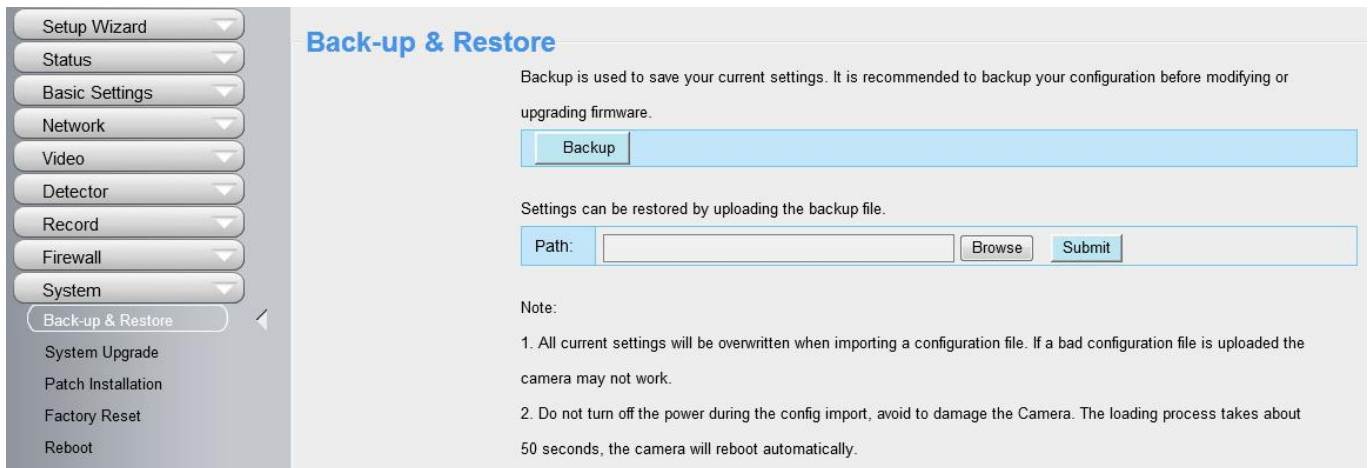

4.8.2 System Upgrade

Click **Download the Latest Firmware**, you will see the following screen. And click **Save** to save the firmware on your computer locally.

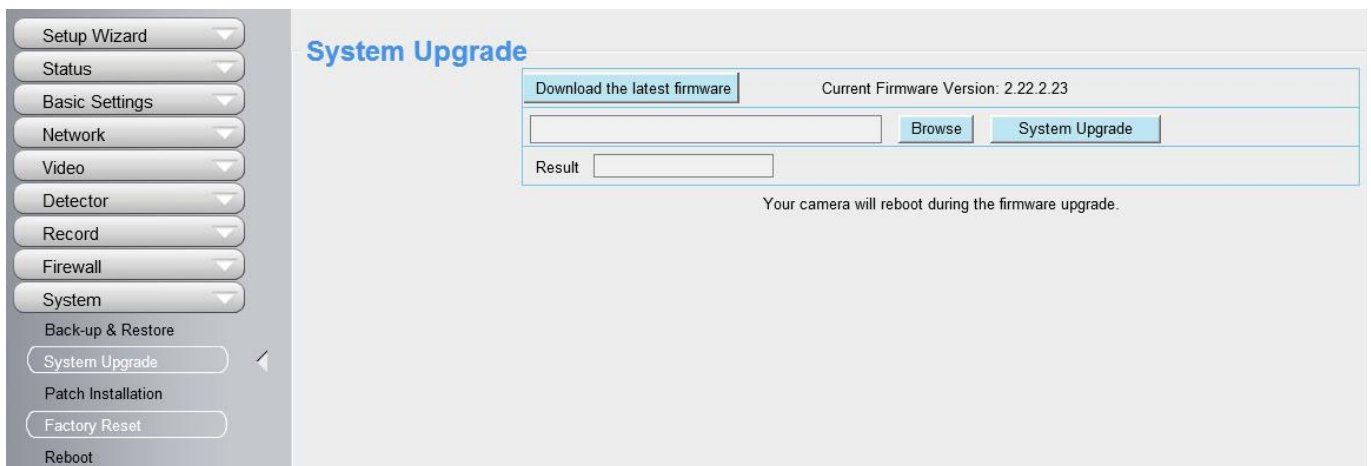

Your current firmware version will be displayed on your screen. You may go to the **Status > Device Information** page to check for the latest firmware versions available.

Click **Browse**, choose the correct bin file and then click **System upgrade**.

Don't shut down the power during upgrade. After upgrading, you can see the upgrade result.

Upgrade Firmware by Equipment Search Tool

Double click the IP Camera Tool shot icon , select the Camera IP that you want to upgrade the firmware. Then select Upgrade Firmware and enter the username and password, choose the firmware file, and upgrade.

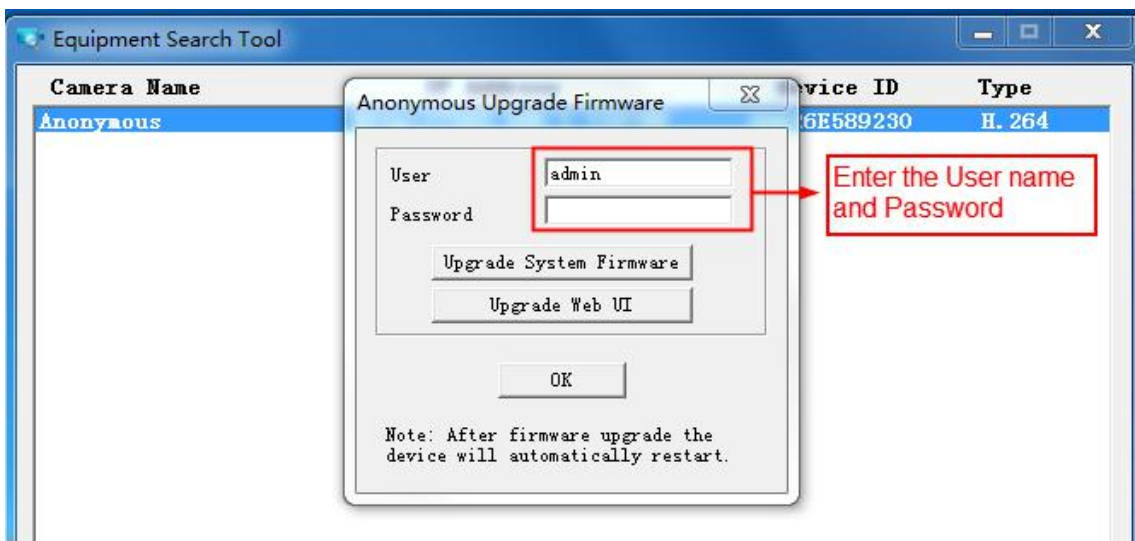
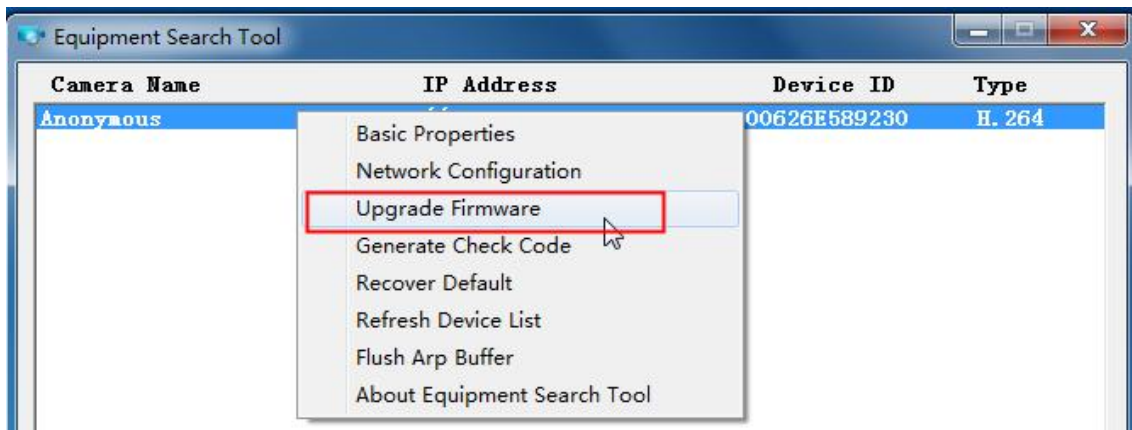

CAUTION: If your camera works well with the current firmware, we recommend not upgrading. Please don't upgrade the firmware unnecessarily. Your camera may be damaged if misconfigured during an upgrade.

NOTE:

- 1) Don't upgrade the firmware through the web UI in WAN, or else the upgrade may be failed.
- 2) Please ensure you have download the correct firmware package for your camera before upgrading. Read the upgrade documentation (readme.txt file) in the upgrade package before you upgrade.
- 3) Upon downloading the firmware check the sizes of the .bin files. They must match the size in the readme.txt file. If not, please download the firmware again until the sizes are the same. Your camera will not function correctly if a corrupt .bin file is used.
- 4) Normally, only Device WEB UI need to be upgrade, please do not try to upgrade the Device Firmware.
- 5) Never shut down the power of the camera during upgrade until the IP camera restart and get connected.
- 6) After upgrade successfully, please clear the cache of browser, uninstall the old plugin and re-install it, then reset the camera to the default factory settings before using the camera.

4.8.3 Patch Installation

Click "Browse" to select the correct patch file, and then click "Install Patch" to install the patch. Do not turn off the power during it installing. After installing is complete, you will receive a system prompt.



4.8.4 Factory Reset

Click **Factory Reset** button and all parameters will return to factory settings if selected.



4.8.5 Reboot

Click **Reboot** to reboot the camera. This is similar to unplugging the power to the camera.

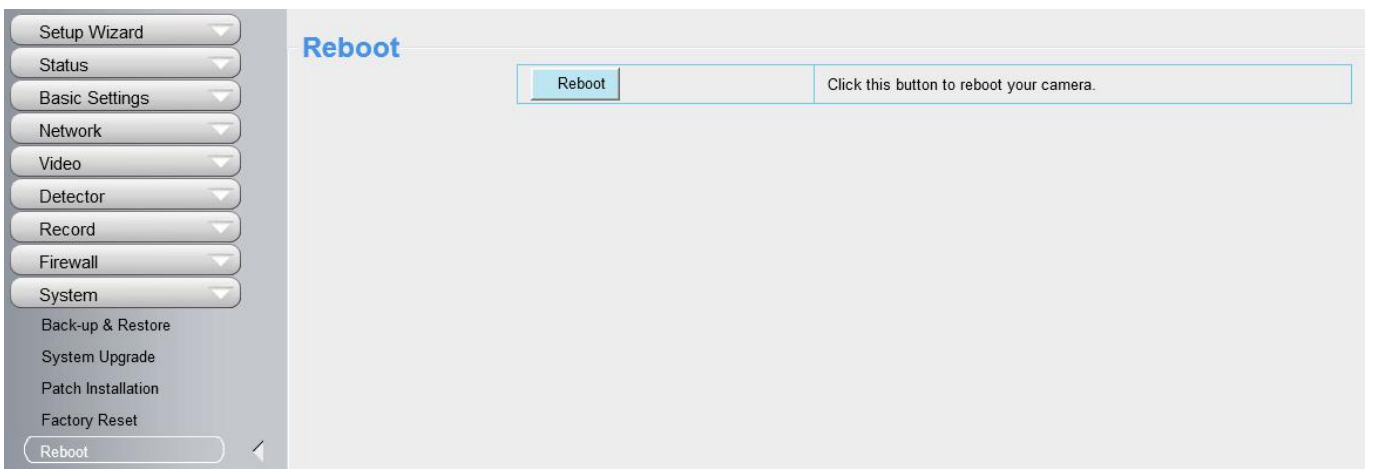

5 Appendix

5.1 Frequently Asked Questions

NOTE: Any questions you would meet, please check Network connections firstly. Check the working status revealed by the indicators on the network server, hub, and exchange. If abnormal, check the network connections.

5.1.1 Install the Add-on of Firefox Browser, Google Chrome and IE Chrome.

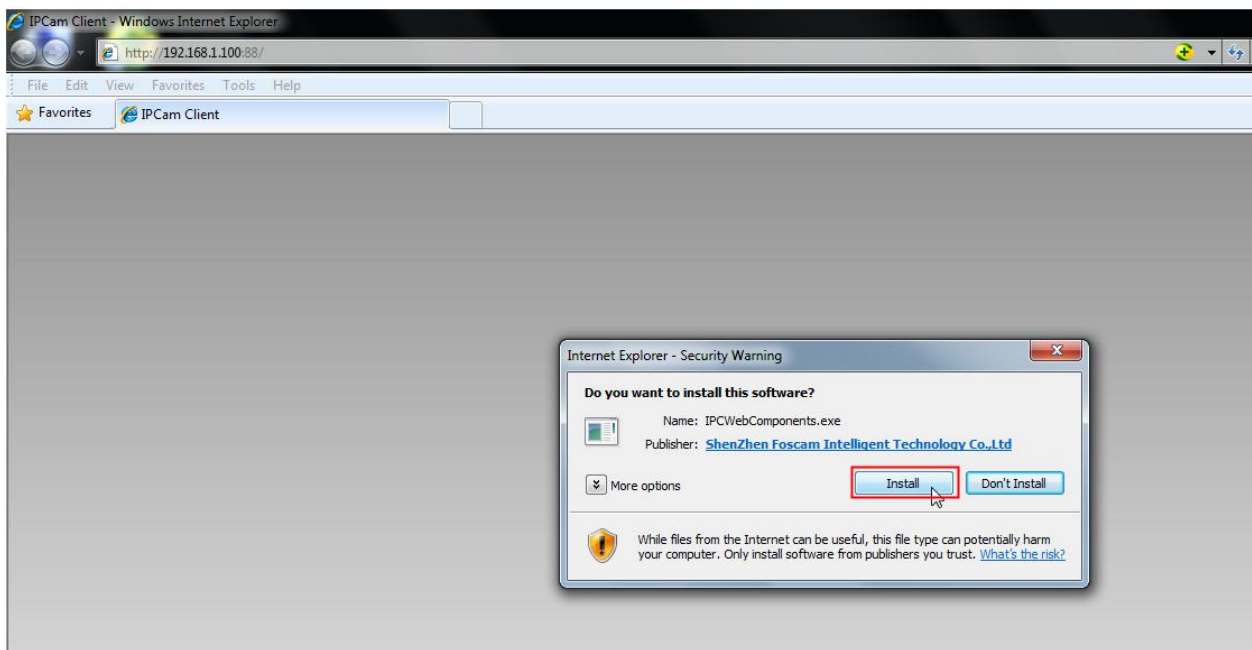

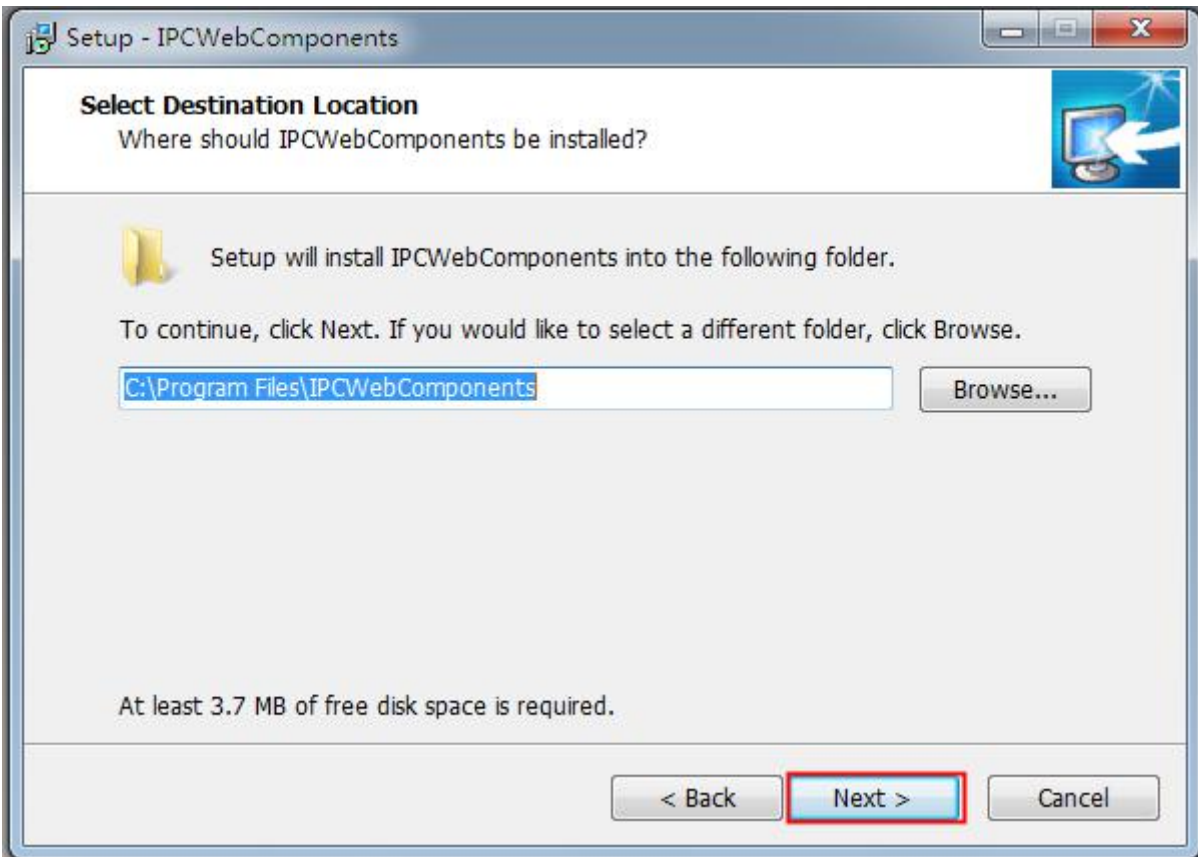

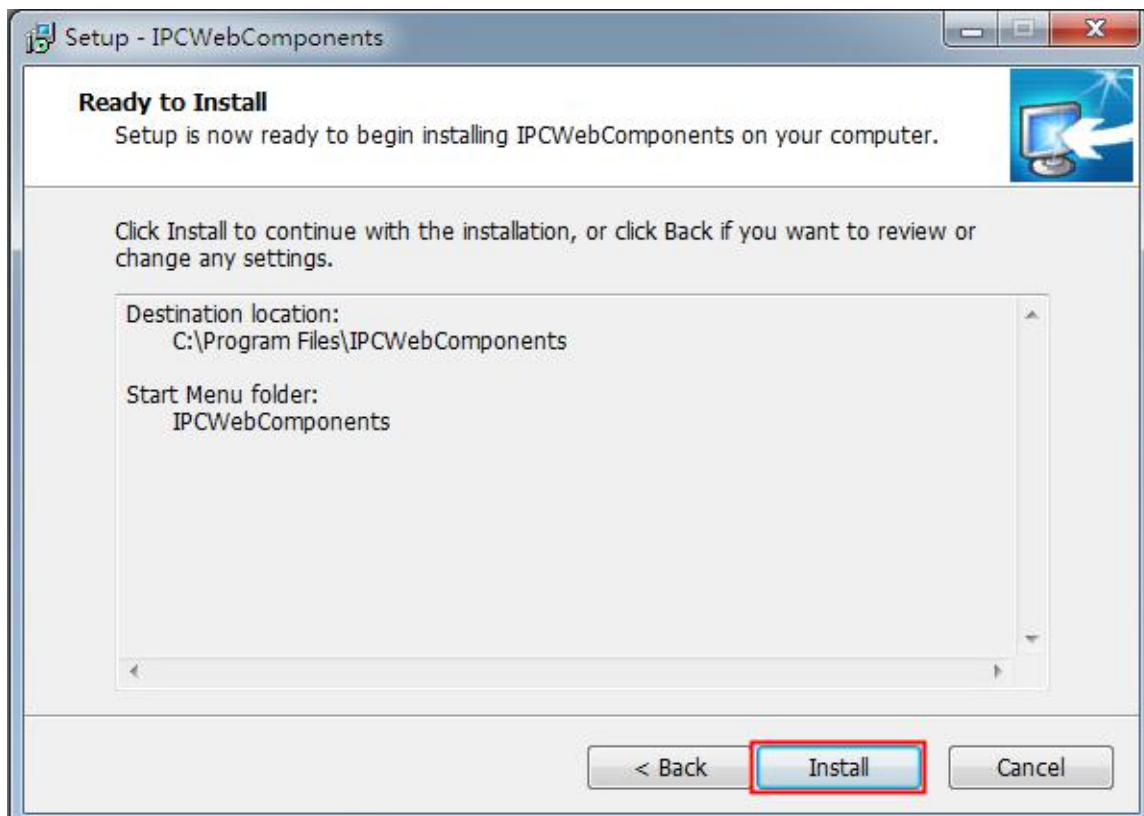
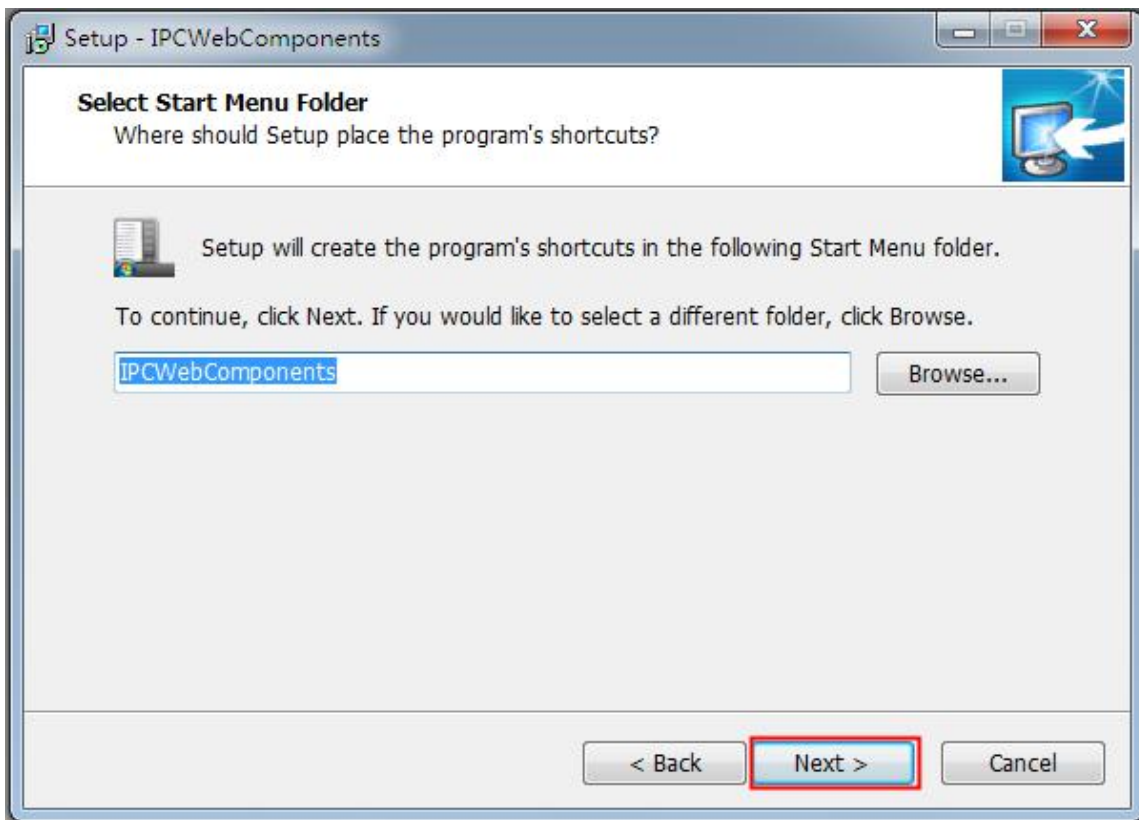

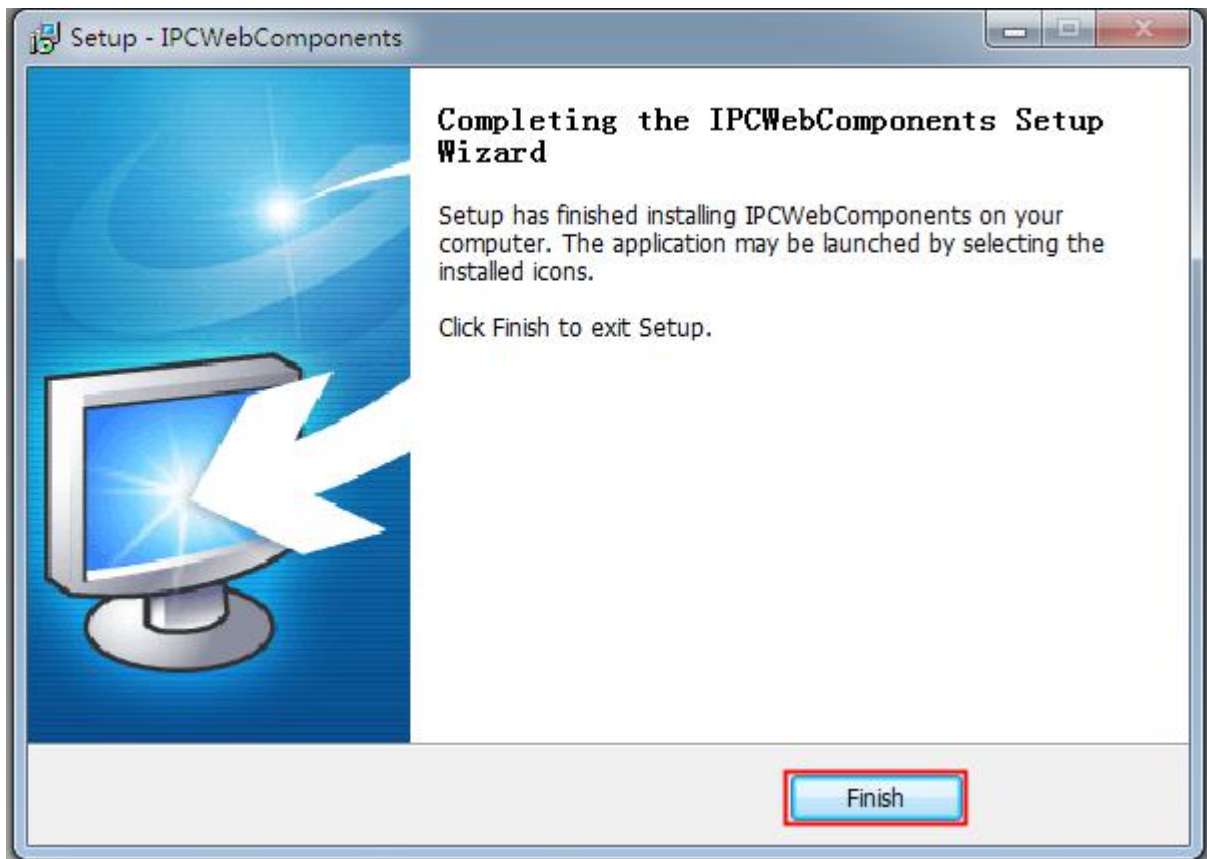

5.1.2 Uninstall the Add-on of Firefox Browser, Google Chrome and IE Chrome.

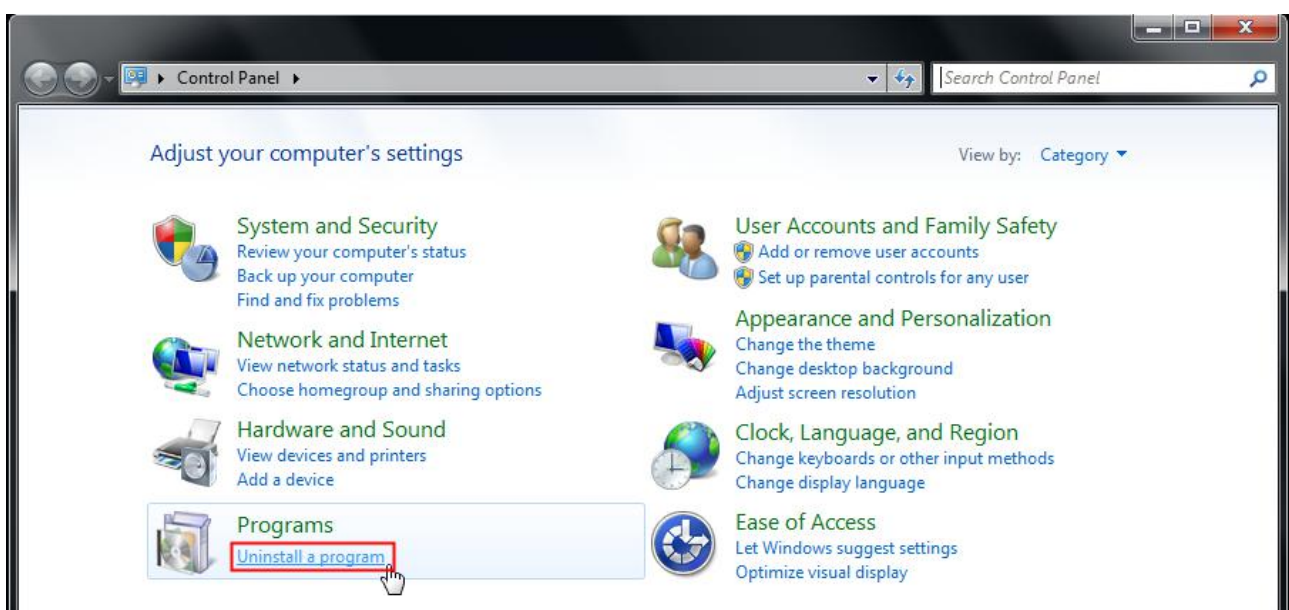
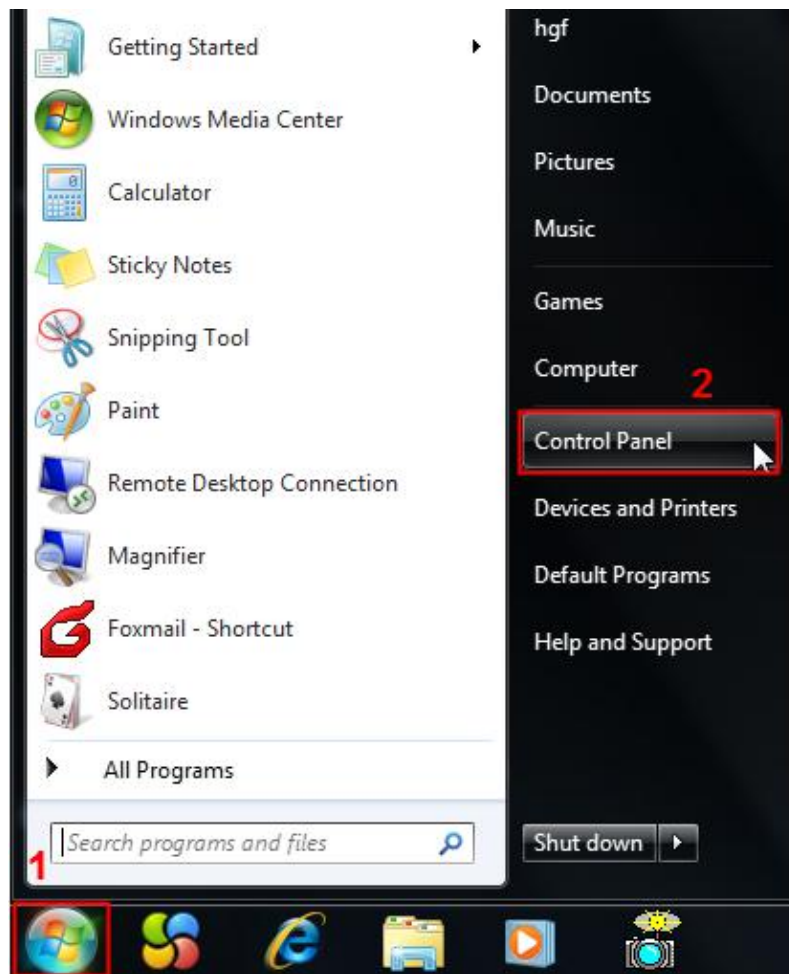

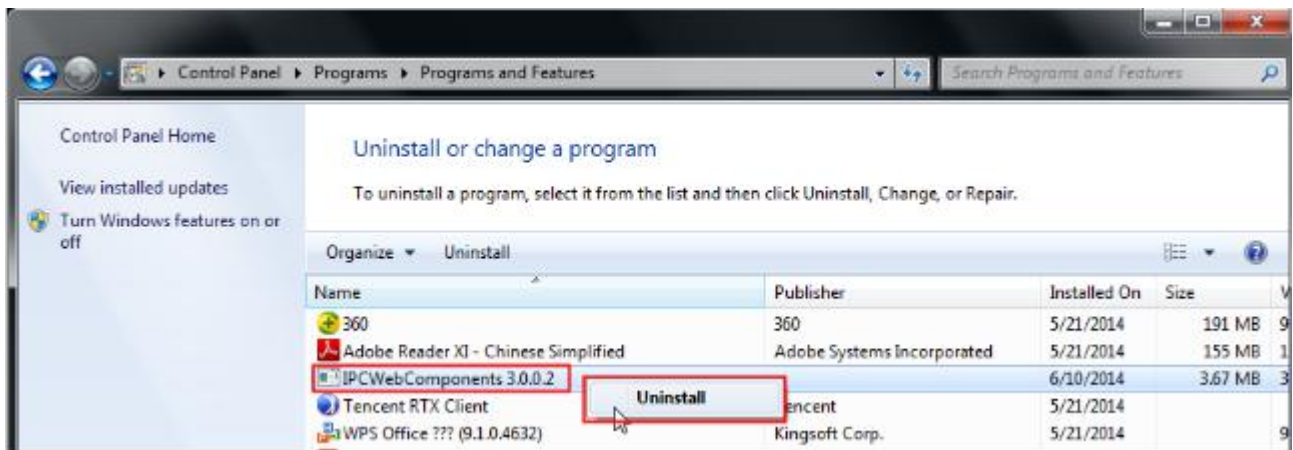

5.1.3 I Have Forgotten the Administrator Password

To reset the administrator username and password, press and hold down the RESET BUTTON for 5 seconds. Upon releasing the reset button, wait for 20 seconds, the camera will reboot and the username and password will return to the factory default administrator username and password. Please power on the camera before reset

Default administrator username: **admin**

Default administrator password: No password

5.1.4 Camera Can not Record

Camera can not record when I click Record button or I can't change the manually record path.

When you use Windows7 or Vista, you may be not able to do manually record or change the record path because of the security settings of computer.

There are two ways to resolve this problem:

(1) Please add the camera as a trusted site to resolve this issue. The steps are

IE browser > Tool > Internet Properties > Security > Trusted Sites > Sites > Add.

(2) Open IE browser, then right click, select **Run as Administrator.**

5.1.5 Subnet Doesn't Match

Check whether your IP camera in the same subnet of your computer. The step is Control Panel(Network Connections (double click Local Area Connections (Choose General(Properties. Check subnet mask, IP address and gateways. When you set IP address please make sure they are in the same subnet. Otherwise you can't access camera.

5.1.6 No Pictures Problems

The video streaming is transmitted by the ActiveX controller. If ActiveX controller isn't installed correctly you will see no video image. You can resolve this problem by this way:

Download ActiveX controller and set the safety property of IE in the PC when you view it first time: **IE browser > Tool > Internet Proper > Security > Custom Level > ActiveX control and Plug-ins.** Three options of front should be set to be **Enable**, The ActiveX programs read by the computer will be stored. As follows:
Enable: Download unsigned ActiveX controls

Enable: Initialize and script ActiveX controls not marked as safe
Enable: Run ActiveX controls and plug-ins

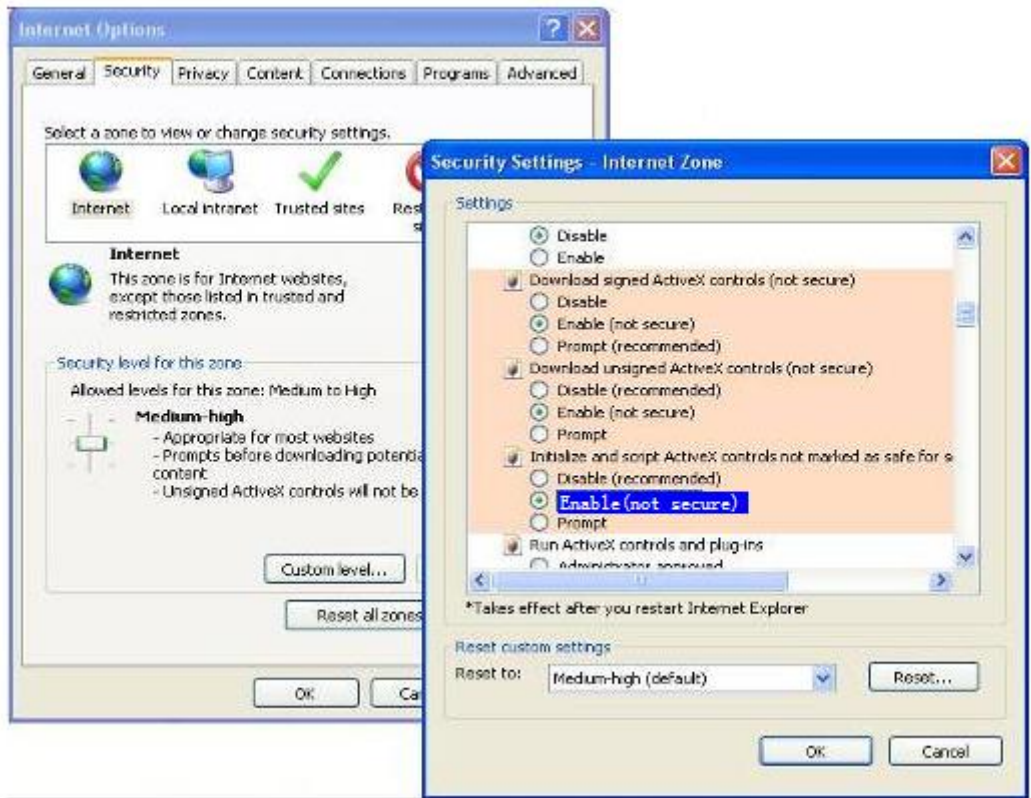

If you allow the ActiveX running, but still could not see living video. Please change another port number to try. Don't use port 8000.

		Save	Refresh
HTTP Port	88		
Media Port	88		
HTTPS Port	443		

NOTE: Make sure that your firewall or anti-virus software does not block the camera or ActiveX. If you could not see video, please shut down firewall or anti-virus software to try again.

5.1.7 Can't Access IP Camera in Internet

There are some reasons:

1. ActiveX controller is not installed correctly
2. The port which camera used is blocked by Firewall or Anti-virus software. Please change another port number and try again.
3. Port forwarding is not successful

Check these settings and make sure they are correct.

5.1.8 UPnP Always Failed

UPnP only contains port forwarding in our recent software. Sometimes, it may be failed to do port forwarding

automatically because of firewall or anti-virus software. It also has much relation with router's security settings. So we recommend you do port forwarding manually. You can view your camera in internet successfully after you do port forwarding manually in your router(Figure 4.30).

5.1.9 Can't See Other Cameras Listed in Multi-device When Using Remote Access

If you want to view all the cameras via the WAN, verify that each camera added in the multi-device settings can be accessed by using the DDNS name and port number. Use the DDNS domain name not the camera's LAN IP. (For more details see: How to add cameras in WAN)

5.2 Default Parameters

Default network Parameters

IP address: obtain dynamically

Subnet mask: obtain dynamically

Gateway: obtain dynamically

DDNS: Embedded FOSCAM domain name

Username and password

Default admin username: admin with a blank password

5.3 Specification

ITEMS		FI9853EP
Image Sensor	Sensor	High Definition Color CMOS Sensor
	Display Resolution	1280 * 720 (1.0M Pixels)
	Min. Illumination	0 Lux (With IR Illuminator)
Lens	Lens Type	Glass Lens
	focal length	f:2.8mm
	Aperture	F2.4
	Diagonal angle of view	75°
	Horizontal view angle	70°
Video	Image Compression	H.264
	Image Frame Rate	30fps(60Hz), 25fps(50Hz), downward adjustable
	Resolution	720P (1280 * 720), VGA (640 * 480), QVGA (320 * 240)
	Stream	dual stream
	Image adjustment	The hue, brightness, contrast, saturation, sharpness are adjustable
	Flip image	flip and mirror
	Infrared mode	Automatic or manual
	Night visibility	With 1 Infrared Lamp Array, IR range up to 20m / 66ft
	Ethernet	One 10/100Mbps RJ45 port

Network	Network Protocol	IP, TCP, UDP, HTTP, HTTPS, SMTP, FTP, DHCP, DDNS, UPnP, RTSP, ONVIF
System Requirements	Operating System	Microsoft Windows 2000/XP, Vista/7/8; Mac OS
	Browser	Microsoft IE8 and above version or compatible browser; Mozilla Firefox; Google Chrome; Apple Safari.
Other Features	Motion Detection	Alarm via E-Mail, upload alarm snapshot to FTP
	Privacy Block	Set privacy area manually
	User Accounts	Three levels user role
	Firewall	Supports IP Filtering
	Reset	Reset button is available
Power	Power Supply	DC 12V/1.0A;PoE (802.3af)
	Power Consumption	4.2 Watts (Max.)
Physical	Dimension (L * W * H)	135mm * 135mm * 98mm / 5.3in * 5.3in * 3.9in
	Net Weight	560g /1.2lb
Environment	Operating Temperature	-20°C ~ 60°C (-°F ~ 140°F)
	Operating Humidity	10% ~ 80% non-condensing
	Storage Temperature	-20°C ~ 60°C (-4°F ~ 140°C)
	Storage Humidity	0% ~ 90% non-condensing
Certification	CE, FCC, RoHS	

Attention: Power adapter should be used between -20°C ~ 40°C, and 20% ~ 90% relative humidity.

5.4 CE & FCC

Electromagnetic Compatibility (EMC)

FCC Statement



This device complies with FCC Rules Part 15. Operation is subject to the following two conditions.

3. This device may not cause harmful interference
4. This device must accept any interference received, including interference that may cause undesired operation.

This equipment has been tested and found to comply with the limits for a Class A digital device, pursuant to Part 15 of the FCC Rules. These limits are designed to provide reasonable protection against harmful interference when the equipment is operated in a commercial environment. This equipment generates, uses, and can radiate radio frequency energy and, if not installed and used in accordance with the installation manual, may cause harmful interference to radio communications. Operation of this equipment in a residential

area is like to cause harmful interference, in which case the user will be required to correct the interference at his own expense.

FCC Caution

Any changes or modification not expressly approved by the party responsible for compliance could void the user's authority to operate this equipment.

This equipment complies with FCC radiation exposure limits set forth for an uncontrolled environment.

This equipment should be installed and operated with minimum distance 20cm / 7.9in between the radiator& your body.

This transmitter must not be co-located or operating in conjunction with any other antenna or transmitter.

CE Mark Warning



This is a Class B product. In a domestic environment, this product may cause radio interference, in which case the user may be required to take adequate measures.

5.5 Warranty

FOSCAM values your business and always attempts to provide you the very best of service.

No limited hardware warranty is provided by FOSCAM unless your FOSCAM product ("product") was purchased from an authorized distributor or authorized reseller. Distributors may sell products to resellers who then sell products to end users. No warranty service is provided unless the product is returned to an authorized return center in the region where the product was first shipped by FOSCAM or to the point-of-purchase, which may have regional specific warranty implications.

If you purchase your FOSCAM product from online store, please contact the point-of-purchase and ask for return / replacement / repair service.

Limited Hardware Warranty

FOSCAM products are warranted to be free from manufacturing defects in materials and workmanship starting from the shipping date of FOSCAM.

This limited hardware warranty does not cover:

- Software, including the software added to the products through our factory-integration system, software that included in the CD,etc.
- Usage that is not in accordance with product instructions.
- Failure to follow the product instructions.
- Abuse firmware upgrade without the authorized technician's guidance.
- Normal wear and tear.

Return Procedures

- Please read FOSCAM warranty policy & policy of your reseller first before sending items back to point-of-purchase.
- Customer must first contact point-of-purchase to obtain a Return Merchandise Authorization (RMA) number before returning the product. If the product you received is suspected to be defective and the

product warranty has not expired, The RMA number will allow your reseller to track your return much easier and help them expedite processing your request.

- After receiving your RMA case number, pack the item(s) very well with the original box and all the original accessories included such as power adapters, brackets, cables, manuals, and driver CD disks.
- Write your RMA number and the return reason (the problem of the product) on the warranty card along with the complete package to send them back.

Replacement Services

- **If customers ask for replacement service, please contact point-of-purchase and follow their policy.**
- Our technicians will inspect all items returned for replacement requests. If the returned product is found in working order, we will return the same item received. However customers shall be responsible for all shipping & handling charges incurred for getting the units back to customers.
- If returned products are found defective, we will replace the product and assume the shipping cost for sending back the replacement unit to customers.
- If for any reason, we are unable to provide a replacement of the original returned item(s). You will have a choice for a "Substitute" item at the same equal value.
- We do not provide exchange and replacement due to normal hardware upgrade according the market after 14 days after the product is delivered.
- Our technicians will test the product before send out the replacement, any other demand for more than two times replacement for the same product during replacement limit will be rejected.
- **Replaced products are warranted from the balance of the former warranty period.**

Warranty Forfeiture

- Warranty is void if purchase from unauthorized distributor or reseller.
- **Warranty is void if trade-mark, serial tags, product stickers have been removed, altered or tampered with.**
- Warranty is void for mishandling, improper use, or defacing the product.
- **Abuse firmware upgrade without the authorized technician's guidance.**
- Warranty is void for physical damage, altered, either internally or externally, improper or inadequate packaging when returned for RMA purposes.
- Warranty is void if damage has resulted from accident, dismantle, abuse, or service or modification by someone other than the appointed vendor, source, fission or the spare part has been over the period of warranty.
- Warranty is void if product is damaged due to improper working environment or operation. (For example, improper temperature, humidity, unusual physical or electrical stress or interference, failure or fluctuation of electrical power, static electricity, using wrong power adapter, etc.)
- Warranty is void if damaged by the use of parts not manufactured or sold by FOSCAM.
- Damage caused by improper installation of third-party products.
- Warranty is void if damaged for irresistible cause, such as earthquake, fire, lightning, flood, etc.
- Product beyond limited warranty.

Shipping Fee

- If products are defective or damaged under normal use or operation in the replacement limit, distributors or resellers are responsible for the shipping cost the product back to customers, customers should assume the shipping cost send the product to the point-of-purchase.
- During replacement limit, if customers ask for replacement due to the product does not fit for customer's

personal expectation, customers should be responsible for both shipping fees.

- Customers shall be responsible for both shipping fees if their product is beyond the replacement limit but still within the warranty limit.

Repair Service Out Of Warranty

- FOSCAM provides extra repair service for products out of warranty, which is chargeable. The total fee includes device cost and service fee. Device cost (including accessories) is the standard uniform price provided by FOSCAM.
- Different regions may have different service fees; please contact the point-of-purchase to confirm before you ask for this service.
- Our technicians will quote the total price after inspecting the product. If customers refuse to repair after the quotation, they must pay for the test fee, \$3.5 / hour. If they agree with the quotation, the test will be free.
- Repaired products out of warranty will obtain a 3-month warranty from the date of the product back to the customer.

Limitation of Liability

- FOSCAM is not responsible for any extra warranty or commitment promised by resellers, if your reseller has promised some extra commitment or warranty; please ask for written documents to protect your rights and interests.
- FOSCAM does not offer refunds under any circumstances. Please contact the point-of-purchase and follow their refund / return policy.
- FOSCAM shall not be liable under any circumstances for any consequential, incidental, special or exemplary damages arising out of or in any connection with this agreement or the products, including but not limited to lost profits, or any claim based on indemnity or contribution, or the failure of any limited or exclusive remedy to achieve its essential purpose or otherwise. Purchaser's exclusive remedy, as against FOSCAM, shall be the repair or replacement of defective parts. If FOSCAM lists a product on its website with a specification in error or that is no longer available for any reason, FOSCAM reserves the right to explain it without incurring any liability.

All rights reserved. FOSCAM and the FOSCAM logo are trademarks of Shenzhen FOSCAM Intelligent Technology Limited., registered in the U.S. and other countries.

5.6 Statement

You are advised to be cautious in daily life, keep personal account information carefully, do not share personal account easily. Change passwords of your account and equipment periodically, and upgrade equipment firmware to strengthen security consciousness.

Our company makes no warranty, implied or otherwise, that this product is suitable for any particular purpose or use. You need to abide by the relevant laws and regulations of the use restrictions when using Foscam cameras. Our company takes no responsibility of illegal activities by using our products.

Our company takes no responsibility of the loss by force majeure, such as failure or faults of telecom system or the Internet network, computer viruses, malicious attacks of hackers, information damage or loss, and faults of computer system.

Foscam company does not need to take any responsibility of the special, incidental or corresponding loss by the products of our company or any software provide by our company, including but not limited to operating loss, profit or purpose. The company only takes the responsibility applicable to national and local legal requirements.

Our company takes no responsibility of the loss caused by the following at ant time:

- 1) loss of purchases;
- 2) loss of intangible property damage, such as data, programs;
- 3) loss of compensation claimed by third-party customers.

Delete images, format the memory card or other data storage devices does not completely remove the original image data. You can restore deleted files from discarded the storage device by commercial software, but which will potentially lead to personal image data used maliciously by others. The privacy of the data security belongs to user responsibility, the company takes no responsibility.

Parts mentioned in this statement should not be understood by the configuration description of the product purchased by the customer, the product configuration must accord to the specific models purchased by the customer.

Without the prior written permission of Foscam company, all the contents of relevant operating instructions manual affiliated to the product must not be reproduced, transmitted, transcribed or stored in a retrieval system, or translated into other languages.

Our company will reserve the right to improve and modify the product and corresponding manuals. The company reserves the right of final interpretation on our products.

6 Obtaining Technical Support

While we hope your experience with the IP camera is enjoyable and easy to use, you may experience some issues or have questions that this User's Guide has not answered.

If you have problem with FOSCAM IP camera, please first contact FOSCAM reseller for solving the problems. If our reseller cannot provide service, please contact our service department: tech@foscam.com.



CE Certificate Website: <http://www.foscam.com/company/ce-certificate.html>