

# **27" RAIDER-165Hz QHD ULTRA GAMING**

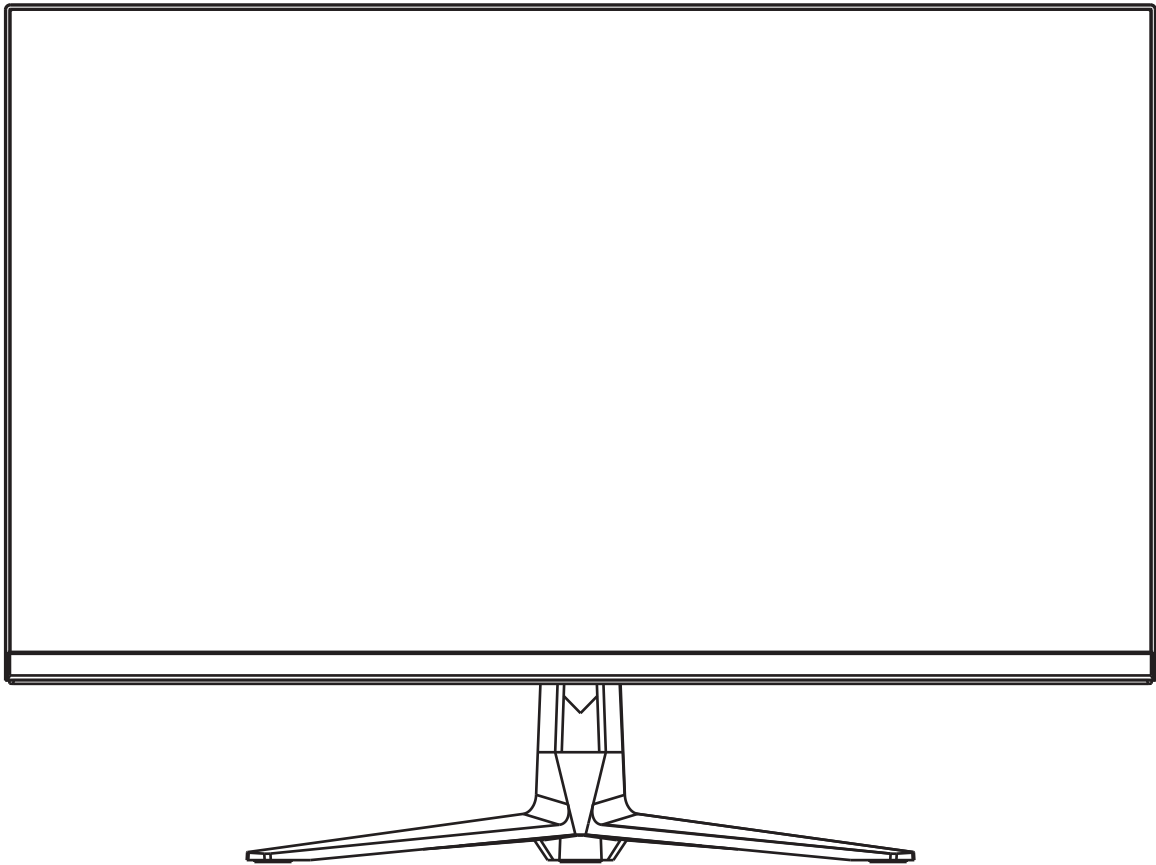

Please read this manual thoroughly before use, and keep it handy for future reference

# GENERAL INFORMATION

## Dear Customer,

Thank you for having purchased this product. This document describes how to install and use the LCD colour monitor. Read this manual which contains information for correct, safe use carefully. Keep this manual at hand so that you can refer to it when needed.

## PRODUCT DESCRIPTION AND TYPE OF USE

The LCD color monitor presents a very rugged structure. It is designed for continuous operation and can be used in closed circuit TV systems without risks of excessive fatigue. The Flat Panel Display has an active matrix, thin-film transistor (TFT), liquid crystal display (LCD).

## GENERAL FEATURES

- Display area
- Wall mounting with not included bracket
- One composite two DP, two HDMI
- Wide inclination to allow viewing either from a seated position or standing up and when moving from one position to the other

Multilingual OSD menu for easy setting and optimization of the display

## OPENING THE BOX

Check that the packing and the contents are not visibly damaged. Contact the retailer immediately if parts are either missing or damaged. Do not attempt to use the device in this case. Send the product back in its original packing if it is damaged.

## CONTENTS OF THE BOX

- LCD monitor
- Power Adaptor
- Power cable
- DP cable
- Audio cable(Optional)
- User's manual

**Important Note:** Accessories may be changed without prior notice.

## **WARNINGS**

### **POWER**

- Only use the power unit provided to power the device. Check mains rating before plugging the power unit in.
- Do not pull the cable to unplug the device.

### **SAFETY PRECAUTIONS**

- Keep the device away from rain and humidity to prevent risk of fire and electrocution. Do not introduce material (solid or liquid) inside. If this should accidentally occur, disconnect the device from the mains and have it inspected by qualified personnel.
- Never open the device. In all cases, contact the qualified personnel or authorized service center for repairs.
- Keep the device away from children, to prevent accidental damage.
- Do not touch the device with wet hands to prevent electrical shock or mechanical damage.
- Do not use the device if it should fall or the external casing is damaged. Risk of electrocution if the device is used in such conditions. Contact the retailer or authorized installer.
- It is advisable to disconnect the power wire if the monitor is not used for a certain time.

### **INSTALLATION PRECAUTIONS**

- To prevent overheating the device, arrange it in a position allowing the flow of air through the slots in the casing. Ensure at least 5 cm of free space when installing inside a rack. For the same reason, do not install sources of heat, such as radiators or hot air ducts. Keep away from direct sunlight. Do not install in areas subject to excessive dust, mechanical vibrations or shocks.
- Do not arrange this device on an unstable surface, such as a tottering or slanted table. The device could fall causing injury or mechanical failures.
- Do not install the device in a place where it could be exposed to humidity or water. Do not direct a jet of water onto the device: risk of fire, electrocution or mechanical failure.
- Stop using the device if water or other material should penetrate inside: risk of fire and electrocution. Contact the retailer or authorized installer.
- Slots and openings in the cabinet are provided for ventilation. These openings must not be blocked or covered.
- Do not place heavy or heat generating objects on top of the device: this could damage the casing and/or increase internal temperature causing faults.
- Do not cover the device with a cloth while it is running to prevent deforming the external casing and overheating the internal parts: risk of fire, electrocution and mechanical failure.
- Keep magnets and magnetized objects away from the device to prevent faults.
- Do not use the device in presence of smoke, vapor, humidity, dust or intense vibrations.
- Wait for a while before operating a device immediately after transporting it from a cold place to a warm place and vice versa. Wait on average for three hours: this will allow the device to adapt to the new ambient (temperature, humidity, etc.).
- The monitor is provided with a plastic base and rubber feet. It can be positioned on a horizontal surface, such as a desk or a table. Make sure that the device is fastened firmly and that it is not resting on unstable supports or surfaces. Dropping could cause severe injury and damage the device.
- Remember to adjust the brightness and contrast to obtain a perfect image.
- The monitor can also be installed on the wall by means of a bracket (not provided).

#### **1.3.4 CLEANING THE DEVICE**

- Rub delicately with a dry cloth to remove dust and dirt.
- Dip the cloth in neutral detergent if dirt cannot be eliminated with a dry cloth alone.
- Do not use volatile liquids (such a petrol, alcohol, solvents, etc.) or chemically treated clothes to clean the device to prevent deformation, deterioration or scratches to the paint finish.

#### **1.3.5 PRIVACY AND COPYRIGHT**

- The LED monitor is a device for Gaming. Recording of images is subject to the laws in force in your country. Recording of images protected by copyright is forbidden.

Product users shall be responsible for checking and respecting all local rules and regulations concerning monitoring and recording video signals. The manufacturing SHALL NOT BE LIABLE for use of this product not in compliance with the laws in force.

## Monitor Inputs

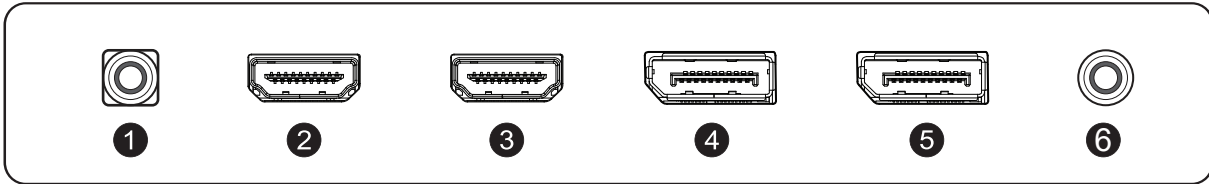

- ① DC 12V
- ② HDMI2
- ③ HDMI1
- ④ DP2
- ⑤ DP1
- ⑥ AUDIO OUT

# Accessories

## PACKAGE INCLUDES



27inch Monitor

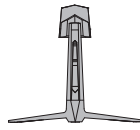

Stand



DP Cable

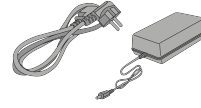

Power Adaptor  
and Power Cable



User Manual

## GETTING STARTED MONITOR CONTROLS

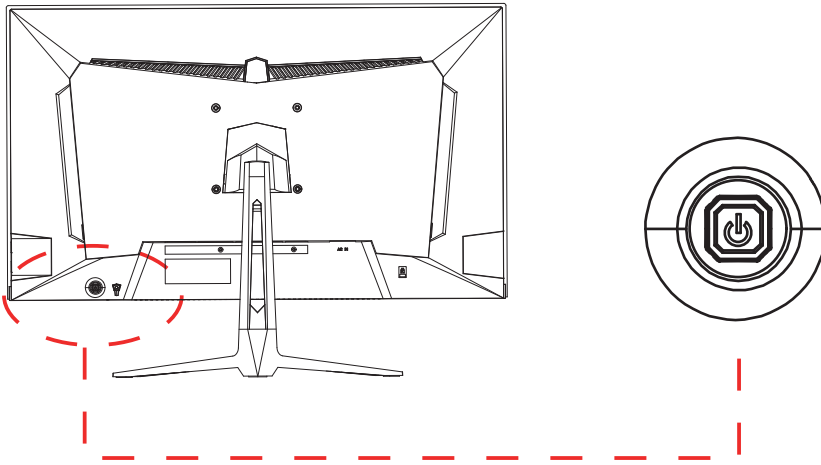

### 1.POWER

Press and hold the switch to turn it on, and take a look to enter the selection menu mode.

### 2.UP

Change the value on selected menu/Switch a menu on OSD.

### 3.DOWN

Change the value on selected menu/ Switch a menu on OSD.

### 4.LEFT

Change the value on selected menu/ Switch a menu on OSD.

### 5.RIGHT

Change the value on selected menu/ Switch a menu on OSD.

## INITIAL SETUP

Connect the monitor to a power outlet.

1. Press the POWER button on the monitor or to turn it on (The indicator will be blue).
2. Connect the relevant cable to the corresponding input on the monitor. The source will be automatically detected.
3. To change between inputs, press the "Source" button to enter the source menu. Use the "◀" and "▶" buttons to choose the input source between Auto Select, DP1, DP2 and HDMI1, HDMI2.

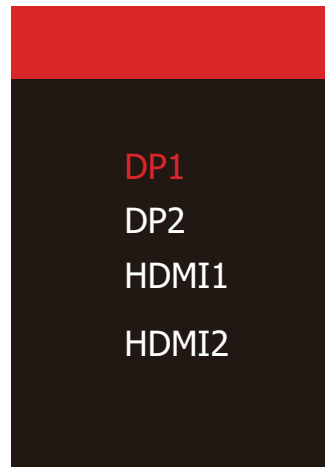

## MENU OPTIONS

The menu for the monitor can be accessed by pressing the menu button on the control panel. This menu is separated into the following sub menus: Picture Settings, Image Settings, Colour Temperature, OSD Settings, Reset, and Miscellaneous options, details of each menu can be found in the following section.

# OSD MENU

## A. Input Source

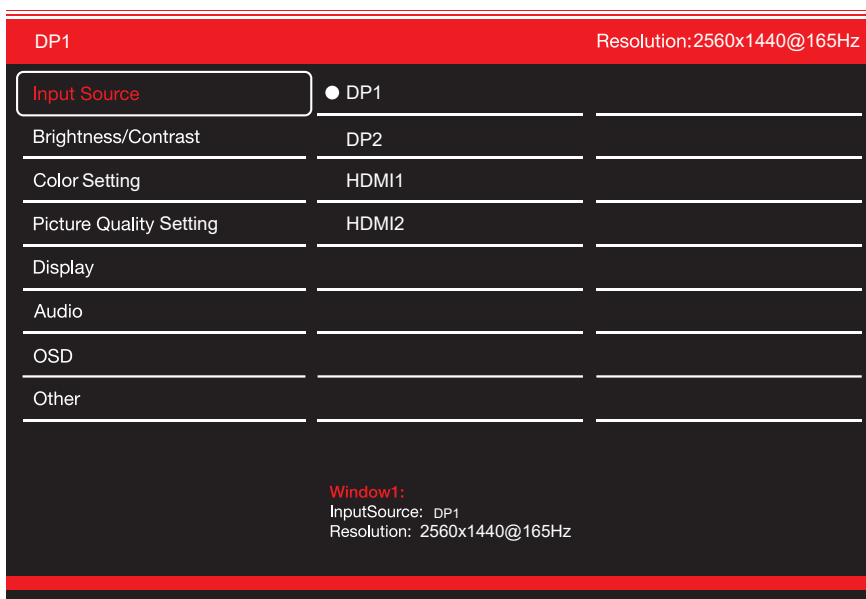

Switch the signal input to DP1,DP2,HDMI1,HDMI2,or have the monitor Auto Select the source.

## B . Brightness/Contrast

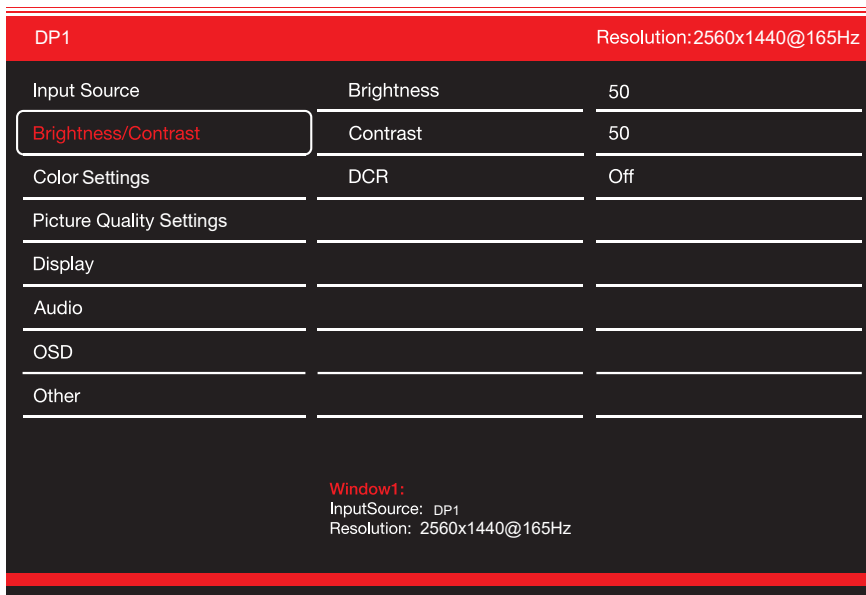

Brightness: Change the display brightness value from 0 to 100.

Contrast: Adjust the display contrast value from 0 to 100.

DCR: Turn the Dynamic Contrast Ratio feature On or Off.



## C . Color Settings

DP1		Resolution:2560x1440@165Hz
Input Source	Gamma	2.2
Brightness/Contrast	Picture Mode	Standard
<b>Color Settings</b>	Color Temperature	Warm
Picture Quality Settings	Hue	50
Display	Saturation	50
Audio	Low Blue Light	0
OSD		
Other		
Window1: InputSource: DP1 Resolution: 2560x1440@165Hz		

Gamma: Change the display Gamma value to:2.0,2.2,2.4.

Pirture Mode: Change the pre-set mode to: Standard, Photo, Movie, Game, FPS or RTS.

Color Temperature: Change the color temperature to:Normal,Warm,Cool,User.

Hue: Change the display Hue value from o to 100.

Saturation: Change the display Saturation value from 0 to 100.

Low Blue Light: Change the display Saturation value from 0 to 100.

## D . Picture Quality Settings

DP1		Resolution:2560x1440@165Hz
Input Source	Sharpness	50
Brightness/Contrast	Response Time	Off
Color Settings	Noise Reduction	Off
<b>Picture Quality Settings</b>	Super Resolution	Off
Display	Dynamic Luminance Control	Off
Audio		
OSD		
Other		
Window1: InputSource: DP1 Resolution: 2560x1440@165Hz		

Sharpness: Change the display Sharpness value from 0 to 100.

Response Time: Select the Response Time Value from,Low,Middle,High or turn it Off.

Noise Reduction: Select the Noise Reduction Value from,Low,Middle,High or turn it Off.

Super Resolution: Select the Super Reduction Value from,Low,Middle,High or turn it Off.

Dynamic Luminance Control: Turn the Dynamic Luminance Control feature On or Off.

## E . Display

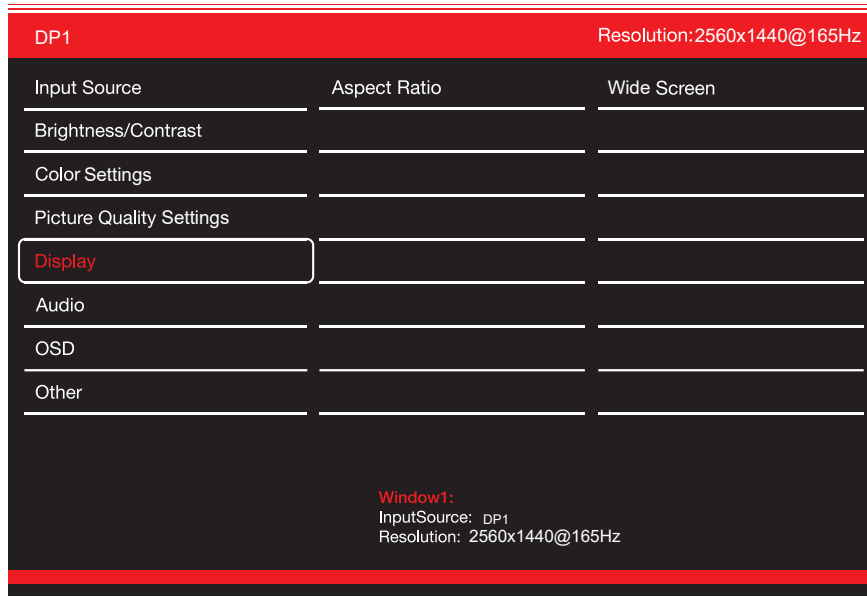

Aspect Ratio: Change the image aspect ratio to Full Screen,Auto,4:3,5:4, or 1:1.

## F . Audio



Mute: Turn On or Off to mute the audio source.

Volume: Change the audio source volume from 0 to 100.

## G . OSD

DP1		Resolution:2560x1440@165Hz
Input Source	Language	English
Brightness/Contrast	OSD H Position	50
Color Settings	OSD V Position	50
Picture Quality Settings	OSD Transparency	20
Display	OSD Timer Out	20
Audio	OSD Rotation	Normal
OSD		
Other		

Window1:  
InputSource: DP1  
Resolution: 2560x1440@165Hz

Language: Change the OSD Menu display language.

OSD H Position: Change the horizontal position of the OSD Menu.

OSD V Position: Change the vertical position of the OSD Menu.

OSD Transparency: Change the transparency value of the OSD Menu from 0 to 100.

OSD Timer Out: Change how long the OSD Menu is on before it automatically exits.

OSD Rotation: Rotate the OSD Menu.

## H . Other

DP1		Resolution:2560x1440@165Hz
Input Source	FreeSync (Adaptive Sync)	Off
Brightness/Contrast	HDR	Off
Color Settings	MPRT	Off
Picture Quality Settings	Flicker Free	Off
Display	LightEffect	Off
Audio	Reset	
OSD		
Other		

Window1:  
InputSource: DP1  
Resolution: 2560x1440@165Hz

FreeSync Mode: Turn FreeSync On or Off.

HDR: Turn HDR On (requires HDMI 2.0 input).

MPRT: On or Off.

Flicker Free: On or Off.

LightEffect: On or Off.

Reset: Press this function to restore the original settings.

## Technical Specificaions

Panel	Model	27" RAIDER 165Hz QHD ULTRA GAMING
	Resolution	2560x1440
	Refresh	165Hz
	Brightness (MAX)	350cd/m <sup>2</sup>
	Response Time (Typical)	1ms
	Aspect Ratio	16:9
	Viewing Angle	178°(H)/178°(V)
	Display Color	1.07B
In/Out	HDMI	x2
	DP	x2
	Audio	OUT
	Color	Black
ETC	Power Consumption	Typical 40W
	VESA Mount	100x100mm
	Power Source	DC 12V,5A
	Operating Temperature	0~50°C
	Remote Control	No
	OSD	Eng/Fr/Spanish/Ger/Korean/Japan/Chinese