

**SMART MODULE**  
(FGS-214)

**DOUBLE SMART MODULE**  
(FGS-224)



## Table of contents

1: Important safety information	4
2: Description and features	5
2.1: Description	5
2.2: Main features	5
3: Specifications	6
4: Installation	7
4.1: Before installation	7
4.2: Electrical connection	8
5: Adding to Z-Wave network	9
5.1: Adding manually	9
5.2: Adding using SmartStart	9
6: Removing from Z-Wave network	10
7: Operating the device	11
7.1: Controlling channels with inputs	11
7.2: Visual indications	11
7.3: Menu	12
7.4: Resetting to factory defaults	12
8: Z-Wave range test	13
9: Activating scenes	14
10: Configuration	15
10.1: Associations	15
10.2: Advanced parameters	17
11: Z-Wave specification	27
12: Regulations	30

# 1: Important safety information

## Read this manual before attempting to install the device!

 Failure to observe recommendations included in this manual may be dangerous or cause a violation of the law. The manufacturer, Fibar Group S.A. will not be held responsible for any loss or damage resulting from not following the instructions of operating manual.

## DANGER OF ELECTROCUTION!

 The device is designed to control other electrical devices and operate in their housings. Faulty connection or use may result in fire or electric shock.

 All works on the device may be performed only by a qualified and licensed electrician. Observe national regulations.

 Even when the device is turned off, voltage may be present at its terminals. Any maintenance introducing changes into the configuration of connections or the load must be always performed with disabled fuse or power supply.

 To avoid risk of electrical shock, do not operate the device with wet or moist hands.

## Do not modify!

 Do not modify this device in any way not included in this manual.

## Other devices

 The manufacturer, Fibar Group S.A. will not be held responsible for any damage or loss of warranty privileges for other connected devices if the connection is not compliant with their manuals.

## This product is intended for indoor use only in dry locations.

 Do not use in damp or wet locations, near a bathtub, sink, shower, swimming pool, or anywhere else where water or moisture are present.

## Not a toy!

 This product is not a toy. Keep away from children and animals!

## 2: Description and features

### 2.1: Description

The remotely operated **FIBARO Smart Module and Double Smart Module** are designed to turn electrical devices or circuits on and off.

Smart Module allows to control one device or circuit and the Double Smart Module allows to control two devices or circuits.

The compact size of the device allows for the product to be installed in the housings of other devices. The devices can be controlled either via the Z-Wave network or with buttons connected directly to them.

### 2.2: Main features

- Works with various types of switches and buttons.
- Supports Z-Wave network Security Modes: S0 with AES-128 encryption and S2 Authenticated with PRNG-based encryption.
- Works as a Z-Wave signal repeater (all non-battery operated devices within the network will act as repeaters to increase reliability of the network).
- May be used with all devices certified with the Z-Wave Plus certificate and should be compatible with such devices produced by other manufacturers.

 The device is a Security Enabled Z-Wave Plus product and a Security Enabled Z-Wave Controller must be used in order to fully utilize the product.

### 3: Specifications

Power supply	100-240V~ 50/60Hz or 24-30V==
Rated load current	<b>Smart Module (FGS-214):</b> 6.5A <b>Double Smart Module (FGS-224):</b> 6A per one channel 9.5A total
Compatible load types	resistive or incandescent only
Active element	micro-gap relay $\mu$
Maximum length of wires	3 meters
Recommended wire cross-section area	0.2–2.0mm <sup>2</sup> (24–14 AWG) (depending on load current)
Operating temperature	0–35°C
Ambient humidity	0–95% RH without condensation
Radio protocol	Z-Wave (500 series chip)
Radio frequency band	868.0–868.6MHz; 869.7–870.0MHz
Max. transmitting power	+5dBm
Range	up to 50m outdoors up to 40m indoors (depending on terrain and building structure)
Dimensions (Height x Width x Depth)	42.5 x 38.25 x 20.3 mm
Classification of installation and use	Automatic electrical control for use in equipment for household or similar use
Mode of operation	Type 1.C Action
Pollution degree	2
Software class	Class A
Protection against electric shock class	Class 0
Compliance with EU directives	2011/65/EU 2015/863 2014/53/EU

**i** Radio frequency of individual device must be same as your Z-Wave controller. Check information on the box or consult your dealer if you are not sure.

## 4: Installation

### 4.1: Before installation



**Connecting the device in a manner inconsistent with this manual may cause risk to health, life or material damage.**

- **Do not** power the device before fully assembling it in the protected environment,
- Check the operating/maintenance manual of the device you want to control to make sure the connection is safe and allowed,
- Connect only in accordance with the diagram,
- Always use the same power source for L and IN terminals,
- **Do not** connect devices which are not compliant with the specification or relevant safety standards,
- **Do not** install the device in metal boxes or on metal surfaces for best radio performance.

#### **Notes for diagrams:**

**S1** – terminal for 1st button

**S2** – terminal for 2nd button

**Q/Q1** – output terminal of the 1st channel

**Q2** – output terminal of the 2nd channel

**IN** – input terminal for both channels

**L** – terminal for live wire

**N** – terminal for neutral wire

**B** – maintenance button

**1** – device/system housing

**2** – electrical device

## 4.2: Electrical connection

1. Switch off the mains voltage (disable the fuse) or disable the power supply.
2. Connect with one of the diagrams below:

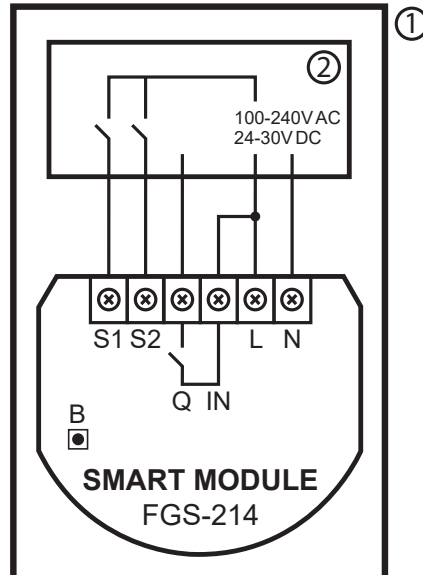

Diagram 1: Example connection of Smart Module

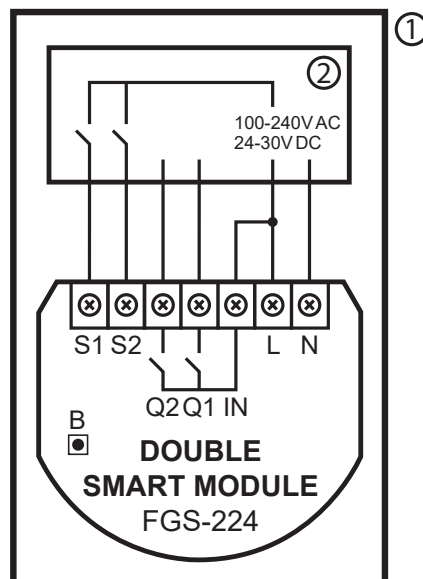

Diagram 2: Example connection of Double Smart Module

3. Verify correctness of connection.
4. Tighten the terminal screws using PH1 screwdriver.
5. If the device fully assembled, switch on the mains voltage or enable the power supply.
6. The LED light means the device is powered.
7. Add the device to the Z-Wave network (see the next chapter).



## 5: Adding to Z-Wave network

**Adding (Inclusion)** – Z-Wave device learning mode, allowing to add the device to existing Z-Wave network.

### 5.1: Adding manually

To add the device to the Z-Wave network **manually**:

1. Power the device.
2. Set the main controller in (Security/non-Security Mode) add mode (see the controller's manual).
3. Quickly, three times click button connected to S1/S2 or the maintenance button.
4. LED will start blinking yellow, wait for the adding process to end.
5. If you are adding in Security S2 Authenticated, input the underlined part of the DSK (label on the bottom of the box).
6. Adding result will be confirmed by the Z-Wave controller's message and the LED:
  - **Green** – successful (non-secure, S0, S2 non-authenticated),
  - **Magenta** – successful (Security S2 Authenticated),
  - **Red** – not successful.

### 5.2: Adding using SmartStart

**SmartStart** enabled products can be added into a Z-Wave network by scanning the Z-Wave QR Code present on the product with a controller providing SmartStart inclusion. SmartStart product will be added automatically within 10 minutes of being switched on in the network range.

To add the device to the Z-Wave network **using SmartStart**:

1. To use SmartStart your controller needs to support Security S2 (see the controller's manual).
2. Enter the full DSK string code to your controller. If your controller is capable of QR scanning, scan the QR code placed on the box or the device label.
3. Power the device.
4. Wait for the adding process to start (up to few minutes), which is signalled with yellow LED blinking.

5. Adding result will be confirmed by the Z-Wave controller's message and the LED:
  - **Green** – successful (non-secure, S0, S2 non-authenticated),
  - **Magenta** – successful (Security S2 Authenticated),
  - **Red** – not successful.

 In case of problems with adding the device, please re-set the device and repeat the adding procedure.

## 6: Removing from Z-Wave network

**Removing (Exclusion)** – Z-Wave device learning mode, allowing to remove the device from existing Z-Wave network. Removing also results in resetting the device to factory defaults.

 Make sure that restoring the parameters to factory defaults will not result in damaging the connected device, we recommend disconnecting it first.

To **remove** the device from the Z-Wave network:

1. Power the device.
2. Set the main controller into remove mode (see the controller's manual).
3. Quickly, three times click the maintenance button.
4. LED will start blinking yellow, wait for the removing process to end.
5. Successful removing will be confirmed by the Z-Wave controller's message and red LED colour.

## 7: Operating the device

### 7.1: Controlling channels with inputs

#### **Momentary switch (parameter 20 set to 0):**

1x click – change the state of the channel to the opposite one

#### **Toggle switch without memory (parameter 20 set to 1):**

1x switch – change the state of the channel to the state of the switch (OFF if contacts opened, ON if contacts closed)

#### **Toggle switch with memory (parameter 20 set to 2):**

1x switch – change the state of the channel to the opposite one

**i** By default S1 input controls 1st channel and S2 input controls 2nd channel if present. It can be changed using parameters 24 and 25.

**i** By default outputs are set as NO (normally open). It means the contacts will be opened when turned off and closed when turned on. It can be switched to NC (normally closed), which means the contacts will be closed when turned off and opened when turned on using parameters 162/163.

### 7.2: Visual indications

The built-in LED light shows current device status.

#### **After powering the device:**

- Green – device added to a Z-Wave network (non-secure, S0, S2 non-authenticated),
- Magenta – device added to a Z-Wave network (Security S2 Authenticated),
- Red – device not added to a Z-Wave network.

#### **Update:**

- Blinking cyan – update in progress,
- Green – update successful,
- Red – update not successful.

#### **Menu:**

- Blinking green – entering the menu (added as non-secure, S0, S2 non-authenticated),

- Blinking magenta – entering the menu (added as Security S2 Authenticated),
- Blinking red – entering the menu (not added to a Z-Wave network),
- Magenta – test Z-Wave network range,
- Yellow – reset to factory defaults.

### 7.3: Menu

**Menu** allows to perform Z-Wave network actions. In order to use the menu:

1. Press and hold the maintenance button to enter the menu.
2. LED will signal adding status for 3 seconds (see 7.2: Visual indications), then turn off for another 3 seconds.
3. Release the button when device signals desired position with colour:
  - **Magenta** – test Z-Wave network range
  - **Yellow** – reset to factory defaults
4. Quickly click the button to confirm.

### 7.4: Resetting to factory defaults

Reset procedure allows to restore the device back to its factory settings, which means all information about the Z-Wave controller and user configuration will be deleted.



Make sure that restoring the parameters to factory defaults will not result in damaging the connected device, we recommend disconnecting it first.



Resetting the device is not the recommended way of removing the device from the Z-Wave network. Use reset procedure only if the primary controller is missing or inoperable. Certain device removal can be achieved by the procedure of removing described.

1. Press and hold the maintenance button to enter the menu.
2. Release button when the device glows yellow.
3. Quickly click the button to confirm.
4. After few seconds the device will be restarted, which is signalled with red LED colour.

## 8: Z-Wave range test

The device has a built in Z-Wave network main controller's range tester.

**i** To make Z-Wave range test possible, the device must be added to the Z-Wave controller. Testing may stress the network, so it is recommended to perform the test only in special cases.

### To test the main controller's range:

1. Press and hold the maintenance button to enter the menu.
2. Release button when the device glows magenta.
3. Quickly click the button to confirm.
4. Visual indicator will indicate the Z-Wave network's range (range signaling modes described below).
5. To exit Z-Wave range test, press the button briefly.

### Z-Wave range tester signalling modes:

- **Visual indicator pulsing green** - the device attempts to establish a direct communication with the main controller. If a direct communication attempt fails, the device will try to establish a routed communication, through other modules, which will be signalled by visual indicator pulsing yellow.
- **Visual indicator glowing green** - the device communicates with the main controller directly.
- **Visual indicator pulsing yellow** - the device tries to establish a routed communication with the main controller through other modules (repeaters).
- **Visual indicator glowing yellow** - the device communicates with the main controller through the other modules. After 2 seconds the device will retry to establish a direct communication with the main controller, which will be signalled with visual indicator pulsing green.
- **Visual indicator pulsing violet** - the device does communicate at the maximum distance of the Z-Wave network. If connection proves successful it will be confirmed with a yellow glow. It's not recommended to use the device at the range limit.
- **Visual indicator glowing red** - the device is not able to connect to the main controller directly or through another Z-Wave network device (repeater).

**i** Communication mode of the device may switch between direct and one using routing, especially if the device is on the limit of the direct range.

## 9: Activating scenes

The device can activate scenes in the Z-Wave controller by sending scene ID and attribute of a specific action using Central Scene Command Class.

By default all action are activated, change settings of parameters 40 and 41 to disable scene activation for selected actions.

Switch	Action	Scene ID	Attribute
Switch connected to S1 terminal	Switch clicked once	1	Key Pressed 1 time
	Switch clicked twice	1	Key Pressed 2 times
	Switch clicked thrice*	1	Key Pressed 3 times
	Switch held**	1	Key Held Down
	Switch released**	1	Key Released
Switch connected to S2 terminal	Switch clicked once	2	Key Pressed 1 time
	Switch clicked twice	2	Key Pressed 2 times
	Switch clicked thrice*	2	Key Pressed 3 times
	Switch held**	2	Key Held Down
	Switch released**	2	Key Released

\* Activating triple clicks will disallow removing using this input.

\*\* Not available for toggle switches.

# 10: Configuration

## 10.1: Associations

**Association (linking devices)** – direct control of other devices within the Z-Wave system network.

Associations allow:

- reporting the device status to the Z-Wave controller (using Lifeline group),
- creating simple automations by controlling other devices without participation of the main controller (using groups assigned to actions on the device).

**i** Commands send to association groups reflect input operation according to device configuration, e.g. turning the first channel on using button will send frame responsible for the same action.

**Smart Module provides the association of 2 groups:**

**1st association group – “Lifeline”** reports the device status and allows for assigning single device only (main controller by default).

**2nd association group – “On/Off (1)”** is used to turn the associated devices on/off reflecting input operation (uses Basic command class).

**Double Smart Module provides the association of 3 groups:**

**1st association group – “Lifeline”** reports the device status and allows for assigning single device only (main controller by default).

**2nd association group – “On/Off (1)”** is used to turn the associated devices on/off reflecting input operation for 1st channel (uses Basic command class).

**3rd association group – “On/Off (2)”** is used to turn the associated devices on/off reflecting input operation for 2nd channel (uses Basic command class).

The device allows to control 5 regular or multichannel devices per an association group, with the exception of “LifeLine” that is reserved solely for the controller and hence only 1 node can be assigned.

### Values sent to association groups depending on settings

Values are sent using Basic Command Class. Values below are default but can be adjusted using parameters 156-161.

Parameter 150/151	Parameter 152/153	Click	Double Click
<b>Momentary or toggle switches with memory (parameter 20/21 set to 0 or 2)</b>			
0, 1 or 3	-	255 (ON) if turned OFF 0 (OFF) if turned ON	99 (max)
2	0 or 1	255 (ON) if turned OFF 0 (OFF) during countdown	99 (max)
	2	255 (ON)	99 (max)
<b>Toggle switches without memory (parameter 20/21 set to 1)</b>			
-	-	255 (ON) if turned OFF 0 (OFF) if turned ON	99 (max)



## 10.2: Advanced parameters

The device allows to customize its operation to user's needs using configurable parameters.

The settings can be adjusted via Z-Wave controller to which the device is added. The way of adjusting them might differ depending on the controller.

In the FIBARO interface parameters are presented as simple options in Advanced Settings of the device.

### Available parameters:

1.	Remember relays state
<b>Description</b>	This parameter determines the state of relays after power supply failure (e.g. power outage). For auto OFF and flashing modes the parameter is not relevant and the relay will always remain switched off.
<b>Parameter size</b>	1B
<b>Default value</b>	1 (restore the state)
<b>Available values</b>	0 – relays remain switched off after restoring power 1 – restore remembered state of relays after restoring power 2 – restore remembered state of relays after restoring power, but for toggle switches (parameter 20/21 set to 1) set the same state as the current state of the switches
20.	S1 input - switch type
<b>Description</b>	This parameter defines as what type the device should treat the switch connected to the S1 terminal.
<b>Parameter size</b>	1B
<b>Default value</b>	0 (momentary switch)
<b>Available values</b>	0 – momentary switch 1 – toggle switch synchronized (contact closed - ON, contact opened - OFF) 2 – toggle switch with memory (device changes status when switch changes status)

<b>21.</b>	<b>S2 input - switch type</b>	
<b>Description</b>	This parameter defines as what type the device should treat the switch connected to the S2 terminal.	
<b>Parameter size</b>	1B	
<b>Default value</b>	0 (momentary switch)	
<b>Available values</b>	0 - momentary switch 1 - toggle switch synchronized (contact closed - ON, contact opened - OFF) 2 - toggle switch with memory (device changes status when switch changes status)	
<b>24.</b>	<b>Inputs orientation</b>	
This parameter allows reversing operation of S1 and S2 inputs without changing the wiring. Use in case of incorrect wiring.		
<b>Parameter size</b>	1B	
<b>Default value</b>	0 (default)	
<b>Available values</b>	0 - default (S1 - 1st channel, S2 - 2nd channel) 1 - reversed (S1 - 2nd channel, S2 - 1st channel)	
<b>25.</b>	<b>Outputs orientation</b>	
<b>Only in Double Smart Module</b>		
This parameter allows reversing operation of Q1 and Q2 outputs without changing the wiring. Use in case of incorrect wiring.		
<b>Parameter size</b>	1B	
<b>Default value</b>	0 (default)	
<b>Available values</b>	0 - default (Q1 - 1st channel, Q2 - 2nd channel) 1 - reversed (Q1 - 2nd channel, Q2 - 1st channel)	

30.	Alarm configuration - 1st slot
<b>Description</b>	This parameter determines to which alarm frames and how the device should react. The parameters consist of 4 bytes, three most significant bytes are set according to the official Z-Wave protocol specification.
<b>Parameter size</b>	4B
<b>Default value</b>	[0x00, 0x00, 0x00, 0x00] (disabled)
<b>Available values</b>	<b>1B</b> [MSB] – Notification Type <b>2B</b> – Notification Status <b>3B</b> – Event/State Parameters <b>4B</b> [LSB] – action:
	<b>0x00</b> – no action, <b>0x01</b> – turn ON, <b>0x02</b> – turn OFF, <b>0x03</b> – turn ON/OFF continuously
31.	Alarm configuration - 2nd slot
<b>Description</b>	This parameter determines to which alarm frames and how the device should react. The parameters consist of 4 bytes, three most significant bytes are set according to the official Z-Wave protocol specification.
<b>Parameter size</b>	4B
<b>Default value</b>	[0x05, 0xFF, 0x00, 0x00] (Water Alarm, any notification, no action)
<b>Available values</b>	<b>1B</b> [MSB] – Notification Type <b>2B</b> – Notification Status <b>3B</b> – Event/State Parameters <b>4B</b> [LSB] – action:
	<b>0x00</b> – no action, <b>0x01</b> – turn ON, <b>0x02</b> – turn OFF, <b>0x03</b> – turn ON/OFF continuously

32.	Alarm configuration - 3rd slot
<b>Description</b>	This parameter determines to which alarm frames and how the device should react. The parameters consist of 4 bytes, three most significant bytes are set according to the official Z-Wave protocol specification.
<b>Parameter size</b>	4B
<b>Default value</b>	[0x01, 0xFF, 0x00, 0x00] (Smoke Alarm, any notification, no action)
<b>Available values</b>	<b>1B</b> [MSB] – Notification Type <b>2B</b> – Notification Status <b>3B</b> – Event/State Parameters <b>4B</b> [LSB] – action:
	<b>0x00</b> – no action, <b>0x01</b> – turn ON, <b>0x02</b> – turn OFF, <b>0x03</b> – turn ON/OFF continuously
33.	Alarm configuration - 4th slot
<b>Description</b>	This parameter determines to which alarm frames and how the device should react. The parameters consist of 4 bytes, three most significant bytes are set according to the official Z-Wave protocol specification.
<b>Parameter size</b>	4B
<b>Default value</b>	[0x02, 0xFF, 0x00, 0x00] (CO Alarm, any notification, no action)
<b>Available values</b>	<b>1B</b> [MSB] – Notification Type <b>2B</b> – Notification Status <b>3B</b> – Event/State Parameters <b>4B</b> [LSB] – action:
	<b>0x00</b> – no action, <b>0x01</b> – turn ON, <b>0x02</b> – turn OFF, <b>0x03</b> – turn ON/OFF continuously

<b>34.</b>	<b>Alarm configuration - 5th slot</b>	
<b>Description</b>	This parameter determines to which alarm frames and how the device should react. The parameters consist of 4 bytes, three most significant bytes are set according to the official Z-Wave protocol specification.	
<b>Parameter size</b>	4B	
<b>Default value</b>	[0x04, 0xFF, 0x00, 0x00] (Heat Alarm, any notification, no action)	
<b>Available values</b>	<b>1B</b> [MSB] – Notification Type <b>2B</b> – Notification Status <b>3B</b> – Event/State Parameters <b>4B</b> [LSB] – action:	
	<b>0x00</b> – no action, <b>0x01</b> – turn ON, <b>0x02</b> – turn OFF, <b>0x03</b> – turn ON/OFF continuously	
<b>35.</b>	<b>Alarm configuration - duration</b>	
<b>Description</b>	This parameter defines duration of alarm sequence. When time set in this parameter elapses, alarm is cancelled and relays restore normal operation, but do not recover state from before the alarm.	
<b>Parameter size</b>	2B	
<b>Default value</b>	600 (10min)	
<b>Available values</b>	0 – infinite 1-32400 (1s-9h, 1s step) – duration	
<b>40.</b>	<b>S1 input - scenes sent</b>	
<b>Description</b>	This parameter determines which actions result in sending scene IDs assigned to them. Values can be combined (e.g. 1+2=3 means that scenes for single and double click are sent). Enabling scenes for triple click disables entering the device in learning mode by triple clicking.	
<b>Parameter size</b>	1B	
<b>Default value</b>	15 (all active)	
<b>Available values</b>	0 – no scenes sent 1 – Key pressed 1 time 2 – Key pressed 2 times 4 – Key pressed 3 times 8 – Key hold down and key released	

<b>41.</b>	<b>S2 input – scenes sent</b>	
<b>Description</b>	<p>This parameter determines which actions result in sending scene IDs assigned to them. Values can be combined (e.g. 1+2=3 means that scenes for single and double click are sent).</p> <p>Enabling scenes for triple click disables entering the device in learning mode by triple clicking.</p>	
<b>Parameter size</b>	1B	
<b>Default value</b>	15 (all active)	
<b>Available values</b>	<p>0 – no scenes sent</p> <p>1 – Key pressed 1 time</p> <p>2 – Key pressed 2 times</p> <p>4 – Key pressed 3 times</p> <p>8 – Key hold down and key released</p>	
<b>150.</b>	<b>First channel – operating mode</b>	
<b>Description</b>	<p>This parameter allows to choose operating mode for channel controlled with Q/Q1 output. For timed modes (value 1, 2 or 3), time is set with parameter 154 and reaction to input change is set with parameter 152.</p>	
<b>Parameter size</b>	1B	
<b>Default value</b>	0 (standard operation)	
<b>Available values</b>	<p>0 – standard operation</p> <p>1 – delayed OFF</p> <p>2 – auto OFF</p> <p>3 – flashing</p>	
<b>151.</b>	<b>Second channel – operating mode</b>	
<b>Only in Double Smart Module</b>		
<b>Description</b>	<p>This parameter allows to choose operating mode for channel controlled with Q2 output. For timed modes (value 1, 2 or 3), time is set with parameter 155 and reaction to input change is set with parameter 153.</p>	
<b>Parameter size</b>	1B	
<b>Default value</b>	0 (standard operation)	
<b>Available values</b>	<p>0 – standard operation</p> <p>1 – delayed OFF</p> <p>2 – auto OFF</p> <p>3 – flashing</p>	

<b>152.</b>	<b>First channel - reaction to input change in delayed/ auto OFF modes</b>	
<b>Description</b>	This parameter determines how the device reacts when changing state of S1 input in timed modes for first channel.	
<b>Parameter size</b>	1B	
<b>Default value</b>	0 (cancel mode)	
<b>Available values</b>	0 – cancel mode and set default state 1 – no reaction, mode runs until it ends 2 – reset timer, start counting time from the beginning	
<b>153.</b>	<b>Second channel - reaction to input change in delayed/ auto OFF modes</b>	
<b>Only in Double Smart Module</b>		
<b>Description</b>	This parameter determines how the device reacts when changing state of S2 input in timed modes for second channel.	
<b>Parameter size</b>	1B	
<b>Default value</b>	0 (cancel mode)	
<b>Available values</b>	0 – cancel mode and set default state 1 – no reaction, mode runs until it ends 2 – reset timer, start counting time from the beginning	
<b>154.</b>	<b>First channel - time parameter for delayed/auto OFF and flashing modes</b>	
<b>Description</b>	This parameter allows to set time parameter used in timed modes for first channel. For delayed/auto OFF modes it determines duration, for flashing mode it determines cycle period.	
<b>Parameter size</b>	2B	
<b>Default value</b>	5 (0.5s)	
<b>Available values</b>	0 – 0.1 seconds 1-32000 – 0.1-3200 seconds, 0.1s step	

<b>155.</b>	<b>Second channel - time parameter for delayed/auto OFF and flashing modes</b>	
<b>Only in Double Smart Module</b>		
<b>Description</b>	This parameter allows to set time parameter used in timed modes for second channel. For delayed/auto OFF modes it determines duration, for flashing mode it determines cycle period.	
<b>Parameter size</b>	2B	
<b>Default value</b>	5 (0.5s)	
<b>Available values</b>	0 – 0.1 seconds 1-32000 – 0.1-3200 seconds, 0.1s step	
<b>156.</b>	<b>S1 input - Switch ON value sent to 2nd association group</b>	
<b>Description</b>	This parameter defines value sent with Switch ON command to devices in 2nd association group when using S1 input.	
<b>Parameter size</b>	2B	
<b>Default value</b>	255	
<b>Available values</b>	0 – turn off 1-99 – turn on and set level 255 – turn on with last level	
<b>157.</b>	<b>S1 input - Switch OFF value sent to 2nd association group</b>	
<b>Description</b>	This parameter defines value sent with Switch OFF command to devices in 2nd association group when using S1 input.	
<b>Parameter size</b>	2B	
<b>Default value</b>	0	
<b>Available values</b>	0 – turn off 1-99 – turn on and set level 255 – turn on with last level	
<b>158.</b>	<b>S1 input - Double Click value sent to 2nd association group</b>	
<b>Description</b>	This parameter defines value sent with Double Click command to devices in 2nd association group when using S1 input.	
<b>Parameter size</b>	2B	
<b>Default value</b>	99	
<b>Available values</b>	0 – turn off 1-99 – turn on and set level 255 – turn on with last level	



<b>159.</b>	<b>S2 input - Switch ON value sent to 3rd association group</b>
<b>Only in Double Smart Module</b>	
<b>Description</b>	This parameter defines value sent with Switch ON command to devices in 3rd association group when using S2 input.
<b>Parameter size</b>	2B
<b>Default value</b>	255
<b>Available values</b>	0 - turn off 1-99 - turn on and set level 255 - turn on with last level
<b>160.</b>	<b>S2 input - Switch OFF value sent to 3rd association group</b>
<b>Only in Double Smart Module</b>	
<b>Description</b>	This parameter defines value sent with Switch OFF command to devices in 3rd association group when using S2 input.
<b>Parameter size</b>	2B
<b>Default value</b>	0
<b>Available values</b>	0 - turn off 1-99 - turn on and set level 255 - turn on with last level
<b>161.</b>	<b>S2 input - Double Click value sent to 3rd association group</b>
<b>Only in Double Smart Module</b>	
<b>Description</b>	This parameter defines value sent with Double Click command to devices in 3rd association group when using S2 input.
<b>Parameter size</b>	2B
<b>Default value</b>	99
<b>Available values</b>	0 - turn off 1-99 - turn on and set level 255 - turn on with last level

<b>162.</b>	<b>Q/Q1 output type</b>	
<b>Description</b>	This parameter determines type of Q/Q1 output.	
<b>Parameter size</b>	1B	
<b>Default value</b>	0 (Normally Open)	
<b>Available values</b>	0 – Normally Open (relay contacts opened turned off, closed when turned on) 1 – Normally Closed (relay contacts closed turned off, opened when turned on)	
<b>163.</b>	<b>Q2 output type</b>	
<b>Only in Double Smart Module</b>		
<b>Description</b>	This parameter determines type of Q2 output.	
<b>Parameter size</b>	1B	
<b>Default value</b>	0 (Normally Open)	
<b>Available values</b>	0 – Normally Open (relay contacts opened turned off, closed when turned on) 1 – Normally Closed (relay contacts closed turned off, opened when turned on)	
<b>164.</b>	<b>Lock simultaneous switching of Q1 and Q2 outputs</b>	
<b>Only in Double Smart Module</b>		
<b>Description</b>	When the lock is enabled, both outputs cannot be turned on at the same time.	
<b>Parameter size</b>	1B	
<b>Default value</b>	0 (lock disabled)	
<b>Available values</b>	0 – lock disabled 1 – lock enabled	

## 11: Z-Wave specification

**Generic Device Class:** GENERIC\_TYPE\_SWITCH\_BINARY

**Specific Device Class:** SPECIFIC\_TYPE\_POWER\_SWITCH\_BINARY

### Supported Command Classes

Command Class	Version	Secure
COMMAND_CLASS_ZWAVEPLUS_INFO [0x5E]	V2	
COMMAND_CLASS_SWITCH_BINARY [0x25]	V1	YES
COMMAND_CLASS_ASSOCIATION [0x85]	V2	YES
COMMAND_CLASS_MULTI_CHANNEL_ASSOCIATION [0x8E]	V3	YES
COMMAND_CLASS_ASSOCIATION_GRP_INFO [0x59]	V2	YES
COMMAND_CLASS_TRANSPORT_SERVICE [0x55]	V2	
COMMAND_CLASS_VERSION [0x86]	V2	YES
COMMAND_CLASS_MANUFACTURER_SPECIFIC [0x72]	V2	YES
COMMAND_CLASS_DEVICE_RESET_LOCALLY [0x5A]	V1	YES
COMMAND_CLASS_POWERLEVEL [0x73]	V1	YES
COMMAND_CLASS_SECURITY [0x98]	V1	
COMMAND_CLASS_SECURITY_2 [0x9F]	V1	
COMMAND_CLASS_CONFIGURATION [0x70]	V1	YES
COMMAND_CLASS_CRC_16_ENCAP [0x56]	V1	
COMMAND_CLASS_NOTIFICATION [0x71]	V8	YES
COMMAND_CLASS_PROTECTION [0x75]	V2	YES
COMMAND_CLASS_CENTRAL_SCENE [0x5B]	V3	YES
COMMAND_CLASS_FIRMWARE_UPDATE_MD [0x7A]	V4	YES
COMMAND_CLASS_APPLICATION_STATUS [0x22]	V1	
COMMAND_CLASS_SUPERVISION [0x6C]	V1	YES
COMMAND_CLASS_MULTI_CHANNEL [0x60] (only in FGS-224)	V4	YES
COMMAND_CLASS_BASIC [0x20]	V1	YES

**Multichannel Command Class (only in FGS-224)**

<b>Endpoint 1</b>
<b>Generic Device Class:</b> GENERIC_TYPE_SWITCH_BINARY
<b>Specific Device Class:</b> SPECIFIC_TYPE_POWER_SWITCH_BINARY
<b>Description:</b> 1st channel
<b>Command Classes:</b>
COMMAND_CLASS_ZWAVEPLUS_INFO [0x5E]
COMMAND_CLASS_SWITCH_BINARY [0x25]
COMMAND_CLASS_ASSOCIATION [0x85]
COMMAND_CLASS_MULTI_CHANNEL_ASSOCIATION [0x8E]
COMMAND_CLASS_ASSOCIATION_GRP_INFO [0x59]
COMMAND_CLASS_SECURITY [0x98]
COMMAND_CLASS_SECURITY_2 [0x9F]
COMMAND_CLASS_SUPERVISION [0x6C]
COMMAND_CLASS_PROTECTION [0x75]
COMMAND_CLASS_NOTIFICATION [0x71]
COMMAND_CLASS_APPLICATION_STATUS [0x22]
<b>Endpoint 2</b>
<b>Generic Device Class:</b> GENERIC_TYPE_SWITCH_BINARY
<b>Specific Device Class:</b> SPECIFIC_TYPE_POWER_SWITCH_BINARY
<b>Description:</b> 2nd channel
<b>Command Classes:</b>
COMMAND_CLASS_ZWAVEPLUS_INFO [0x5E]
COMMAND_CLASS_SWITCH_BINARY [0x25]
COMMAND_CLASS_ASSOCIATION [0x85]
COMMAND_CLASS_MULTI_CHANNEL_ASSOCIATION [0x8E]
COMMAND_CLASS_ASSOCIATION_GRP_INFO [0x59]
COMMAND_CLASS_SECURITY [0x98]
COMMAND_CLASS_SECURITY_2 [0x9F]
COMMAND_CLASS_SUPERVISION [0x6C]
COMMAND_CLASS_PROTECTION [0x75]
COMMAND_CLASS_APPLICATION_STATUS [0x22]

## Notification Command Class

The device uses Notification Command Class to report different events to the controller using “Lifeline” group (only in Root / Endpoint 1).

Notification Type	Event	Parameter	Status
System [0x09]	Heartbeat (Notification CC V5) [0x05]	-	0xFF – enable (non-changeable)

## Protection CC

Protection Command Class allows to prevent local or remote control of the outputs.

Type	State	Description	Hint
Local	0	Unprotected - The device is not protected, and may be operated normally via the user interface.	Inputs connected with outputs.
Local	2	No operation possible – button can not change relay state, any other functionality is available (menu and Central Scenes Notification).	Inputs disconnected from outputs.
RF	0	Unprotected - The device accept and respond to all RF Commands.	Outputs can be controlled via Z-Wave.
RF	1	No RF control – command class basic and switch binary are rejected, every other command class will be handled.	Outputs cannot be controlled via Z-Wave.

## Association groups mapping

Root	Endpoint	Association group in endpoint
Association Group 2	Endpoint 1	Association Group 2
Association Group 3	Endpoint 2	Association Group 2

## 12: Regulations

### Legal Notices

All information, including, but not limited to, information regarding the features, functionality, and/or other product specification are subject to change without notice. Fibaro reserves all rights to revise or update its products, software, or documentation without any obligation to notify any individual or entity.

FIBARO and Fibar Group logo are trademarks of Fibar Group S.A. All other brands and product names referred to herein are trademarks of their respective holders.

### Declaration of conformity

 Hereby, Fibar Group S.A. declares that the device is in compliance with the essential requirements and other relevant provisions of Directive 2014/53/EU, 2011/65/EU and 2015/863. The full text of the EU declaration of conformity is available at the following internet address: [www.manuals.fibaro.com](http://www.manuals.fibaro.com)

### WEEE Directive Compliance



Device labelled with this symbol should not be disposed with other household wastes. It shall be handed over to the applicable collection point for the recycling of waste electrical and electronic equipment.

