

180 min

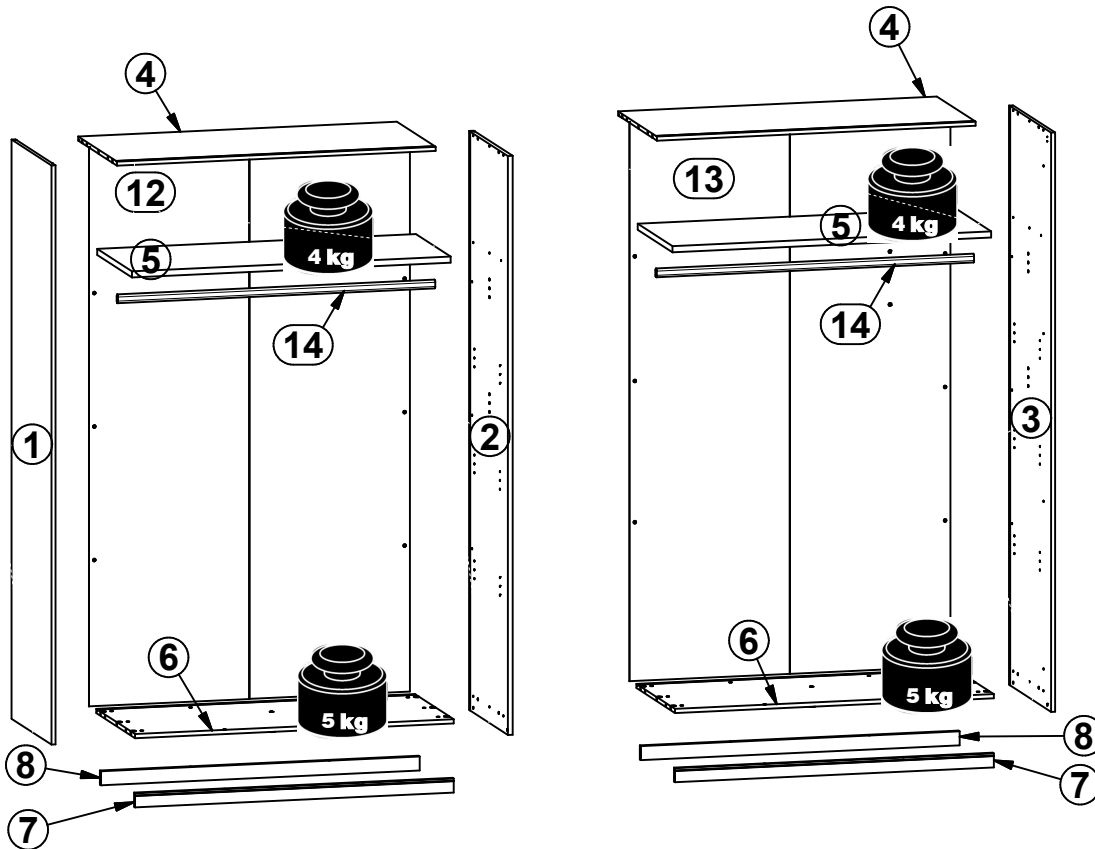

A	B	C (mm)		D
1	L72-1001	2100	551	2/7
2	L72-1003	2099	535	3/7
3	L82-1001	2100	580	2/7
4	L82-3001	1178	535	1/7
5	L82-3002	1178	480	4/7
6	L82-3003	1178	535	1/7
7	L82-4001	1178	51	4/7
8	L82-4002	1178	51	4/7
9	L82-7001	512	1214	5/7 6/7
10	L82-7002	512	1214	5/7 6/7
11	L82-7003	512	1214	5/7 6/7
12	L82-9301	2028	1187	3/7
13	L82-9302	2028	1187	3/7
14	dr-1173	1173	30	4/7

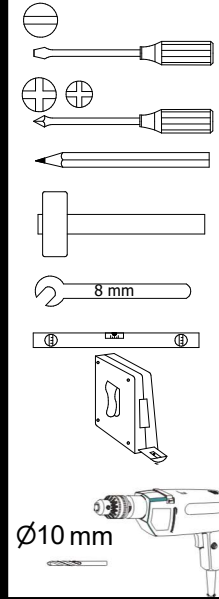
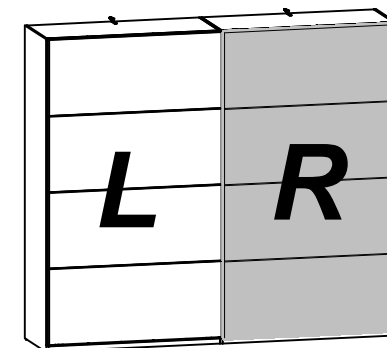

16x d20	12x d28	8x Ø7x50 mm e1	28x Ø6,3x13 mm e5	cm 0 1 2 3 4 5 6 7 8 9 10											
16x Ø6,3x10 mm e50	12x Ø6,3x10 mm e51	24x Ø8x30 mm f1	2x f20	2x Ø10x50 mm f35	2x f55	2x M5x20 mm j148	2x M5 j149	6x k1	2x Ø25M10x13 mm k75 2	2x 86x21x15 1,5 n14 2	2x n45	2x n46 3			
1x n139	18x 90x50 1,5 mm n148	4x n158	2x h188	1x h189	6x n218	4x Ø3,5x13 mm p1	4x Ø3,5x25 mm p16	2x Ø5x60 mm p17	12x Ø3,5x16 mm p25	1x z1	4x Ø3,5x16 mm p38	132x Ø4x13 mm p93			
24x 6,7 7,8 r37	24x Ø20x13,5 mm #19 r54	2x Ø 20mm s68	1x 2368 w122 3	1x w175 5	3x 2050 mm w136 5	1x 2050mm w136 9	8x s1	3x 2050 mm sp-2050	3x w180 1	2x k75 4					

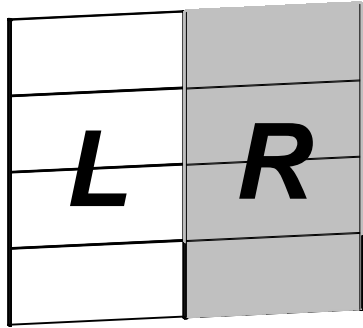

L

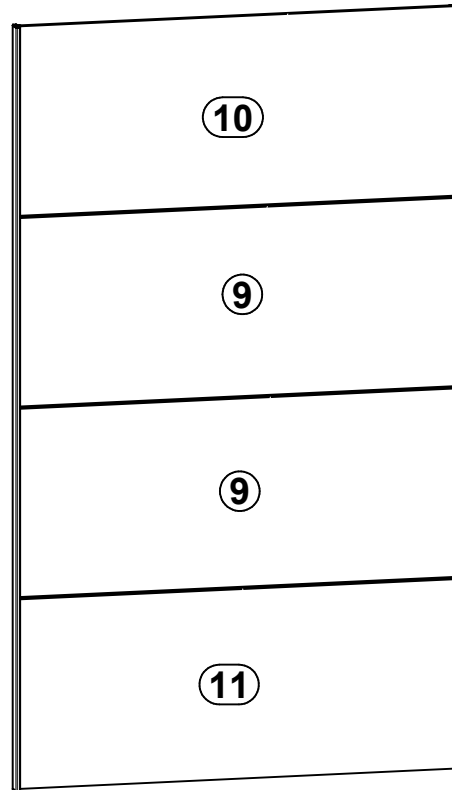

R

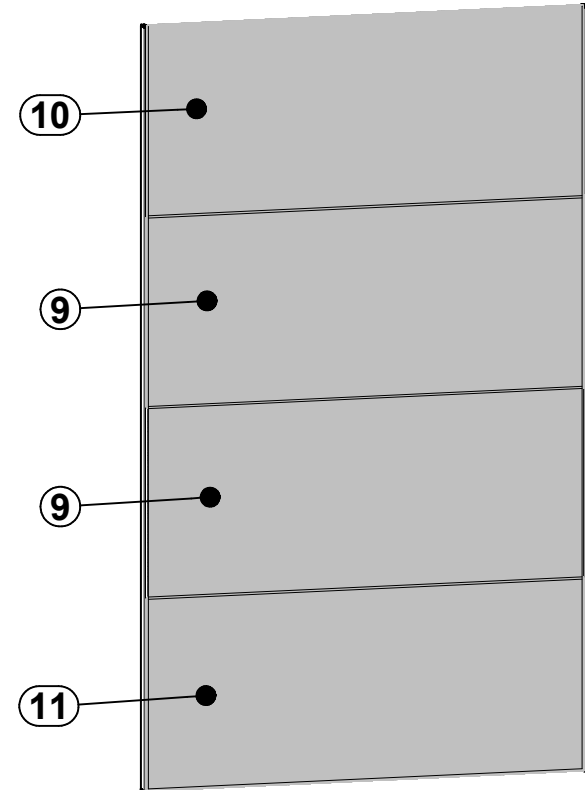

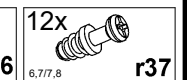
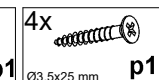
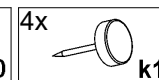
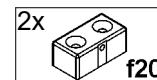
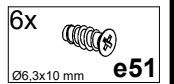
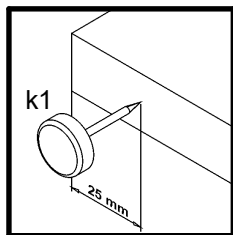
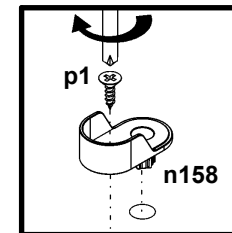
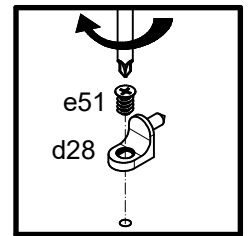
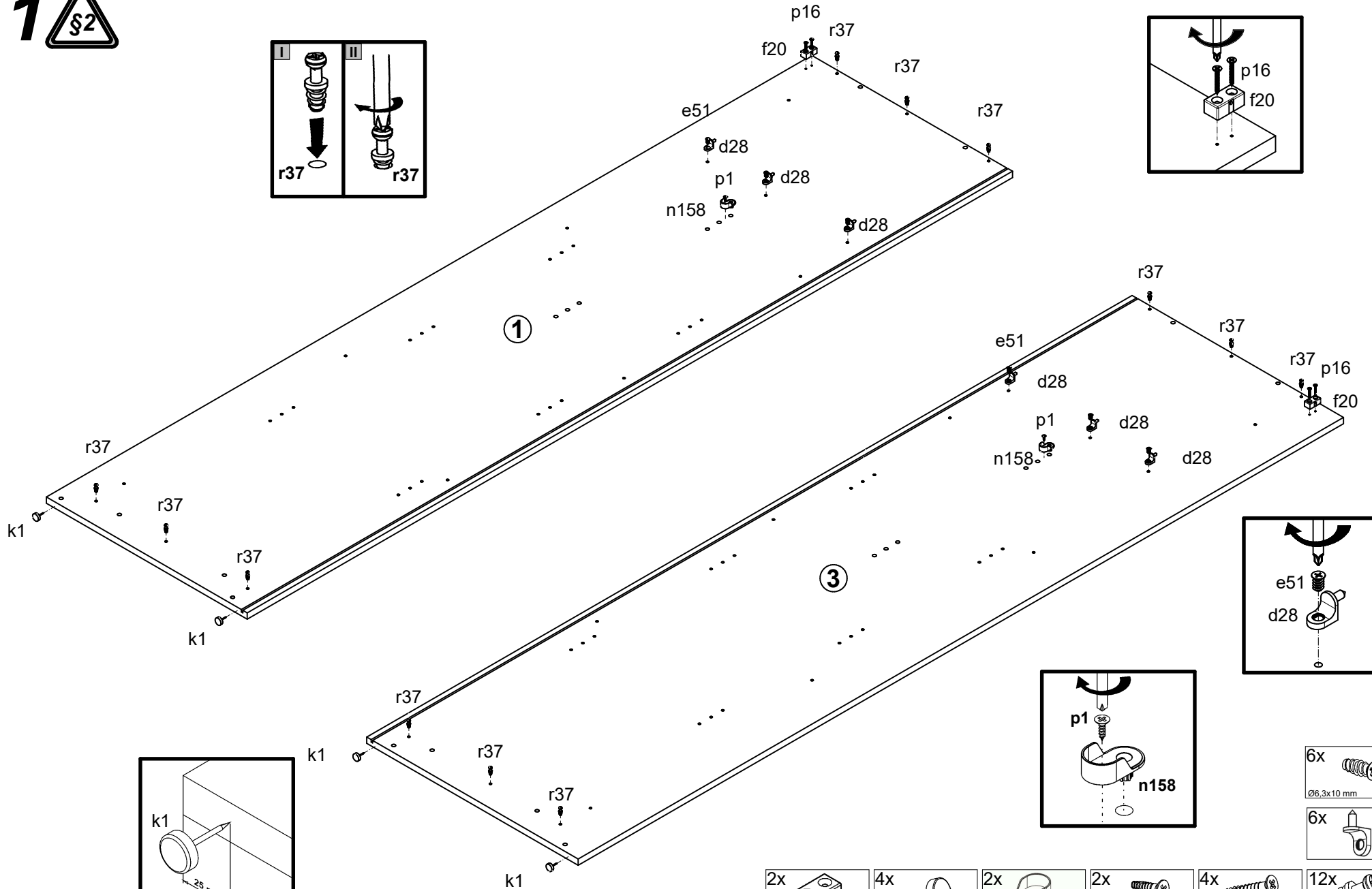
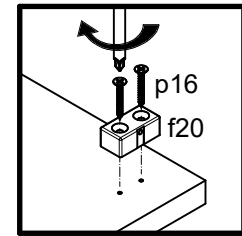
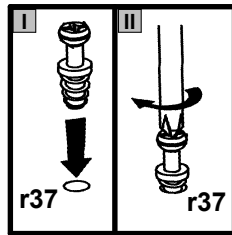

1

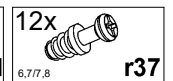
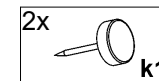
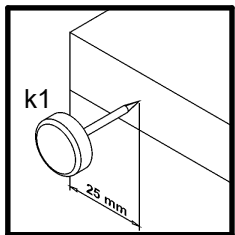
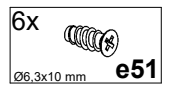
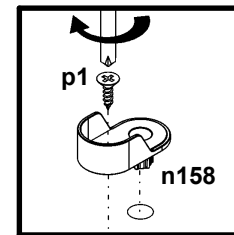
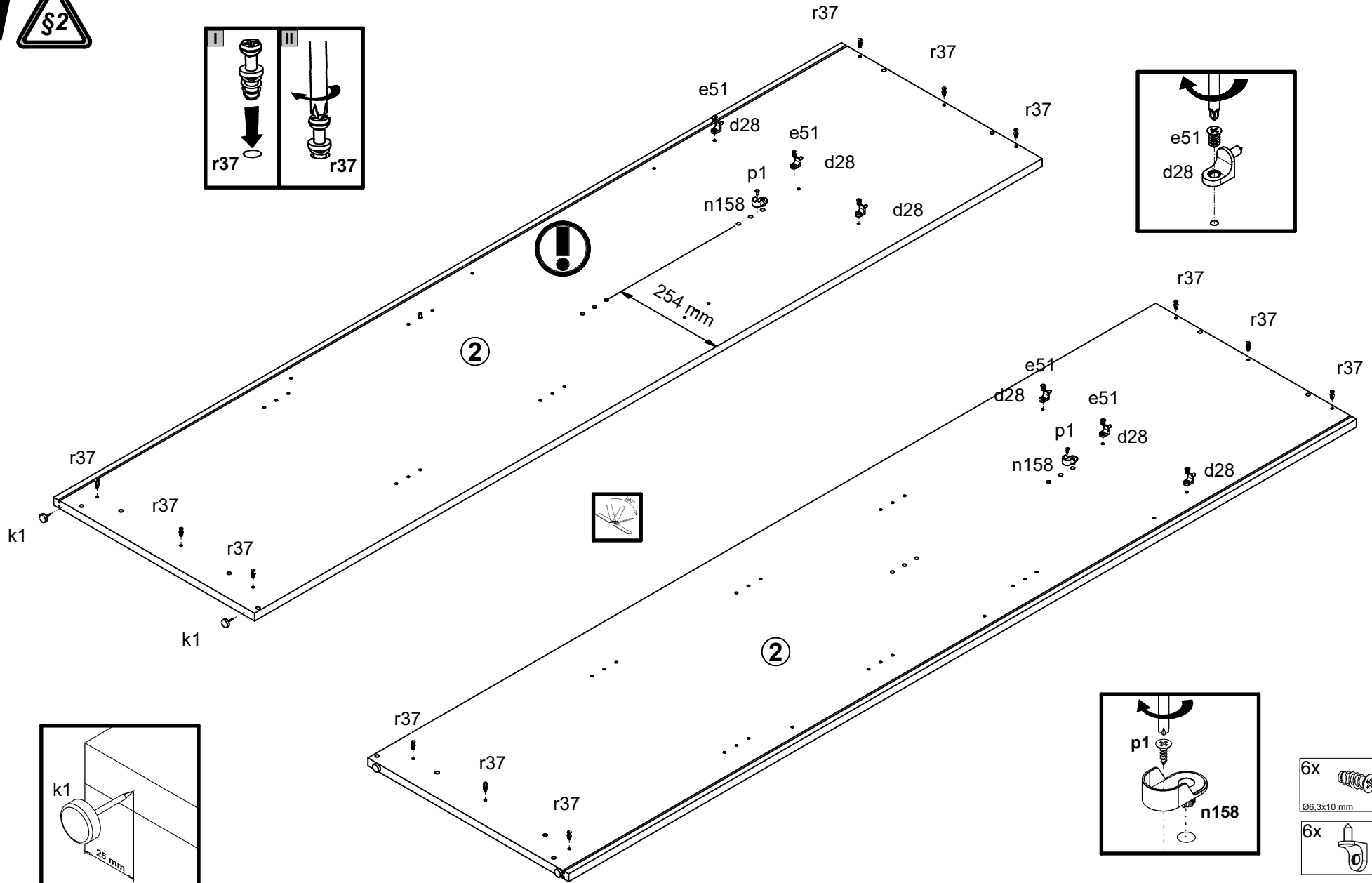
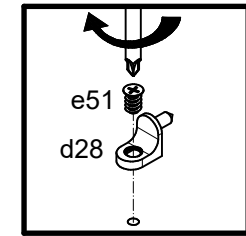
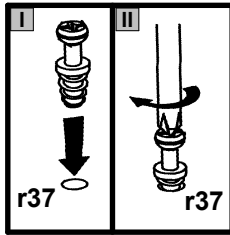

2 

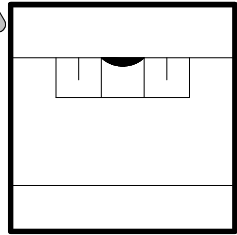



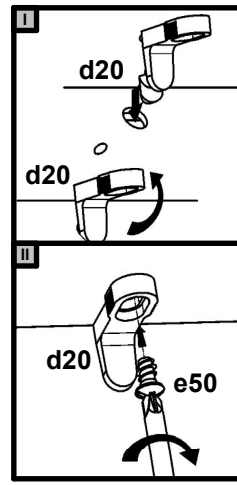
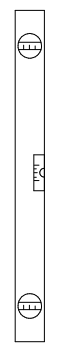
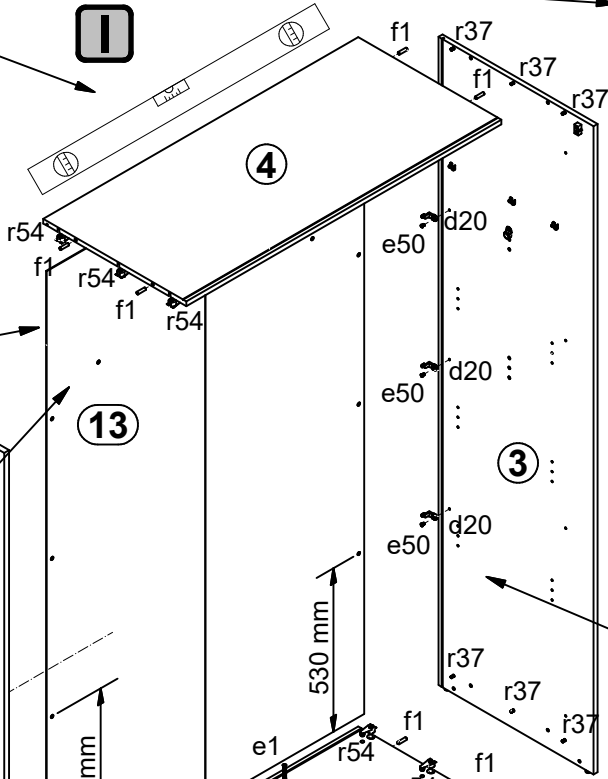



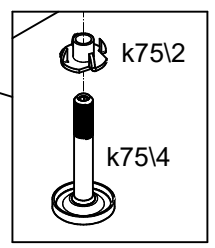
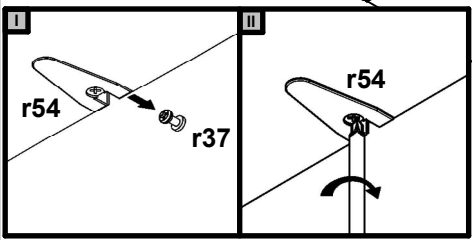
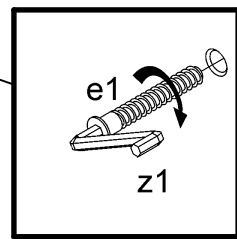
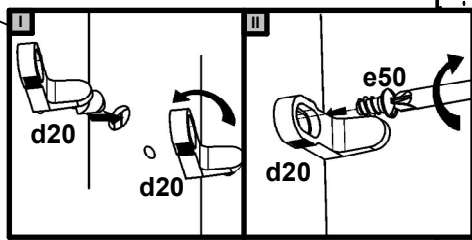
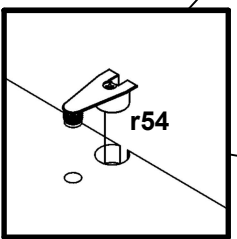
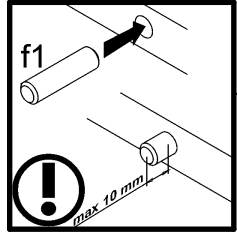
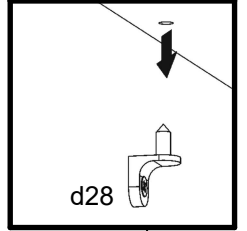

I



II



- 1x  z1
- 1x  k75/4
- 1x  #19
- 4x  e1
- 8x  d20
- 8x  e50
- 12x  f1
- 12x  r54

3

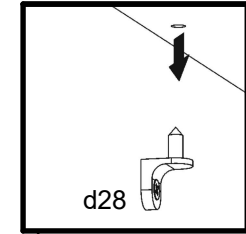
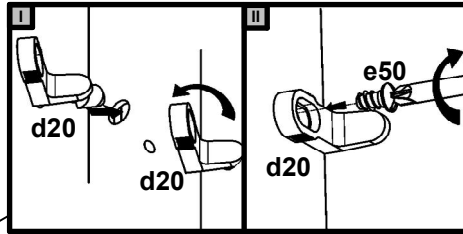
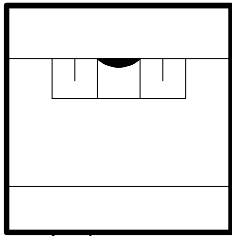
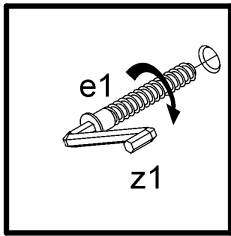

I

II

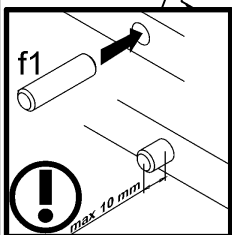
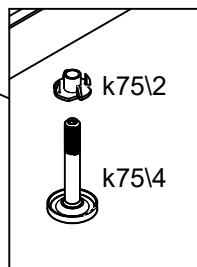
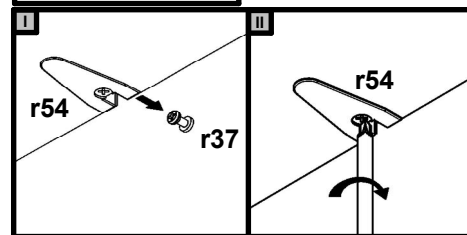
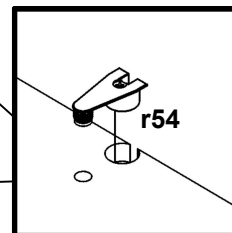
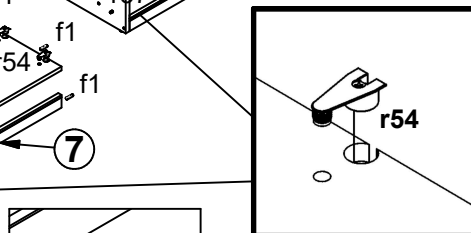
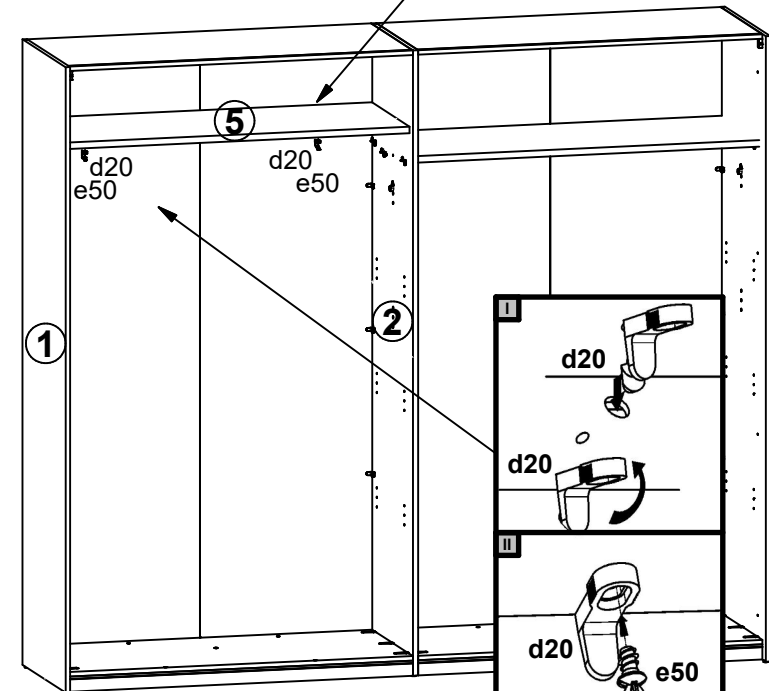
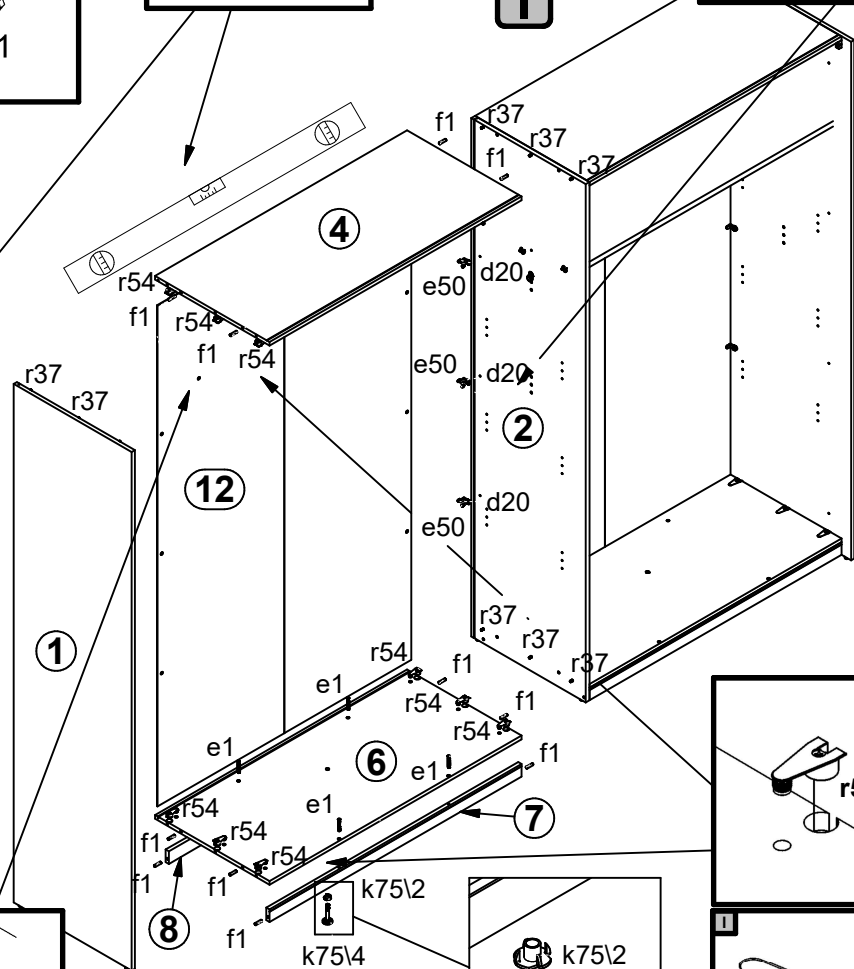
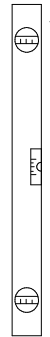

1x 	4x Ø7x50 mm	1x 	1x Ø25x10x13 mm
8x 	8x Ø6,3x10 mm	12x Ø8x30 mm	12x Ø20x13,5 mm

4

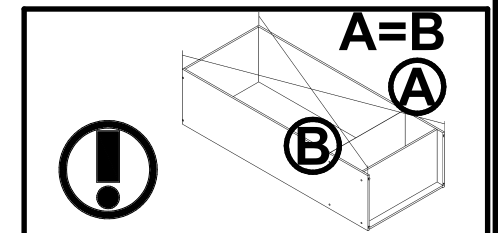
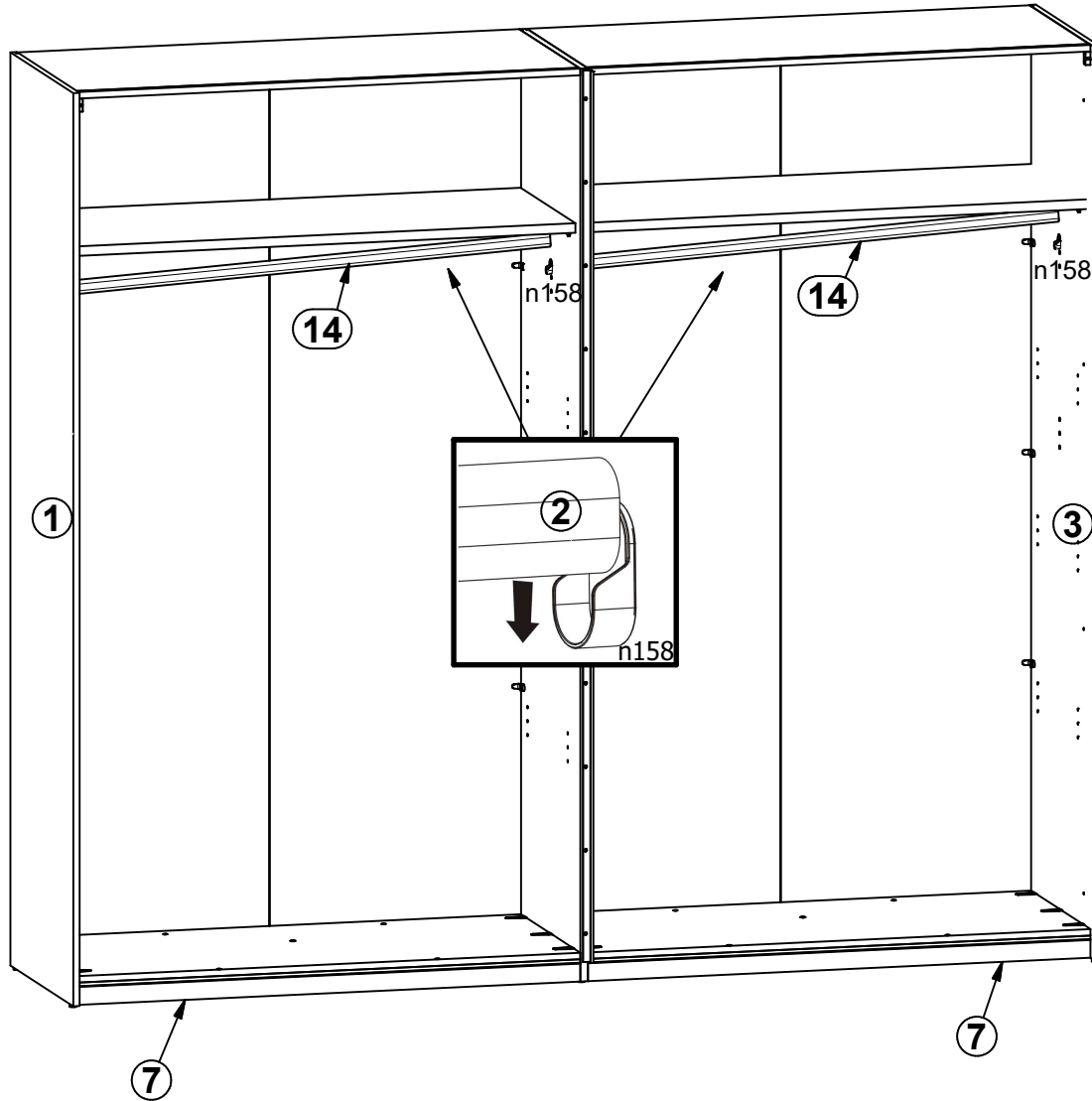

5



4 mm

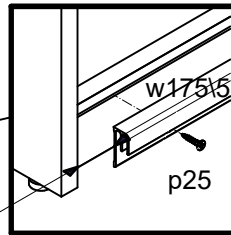
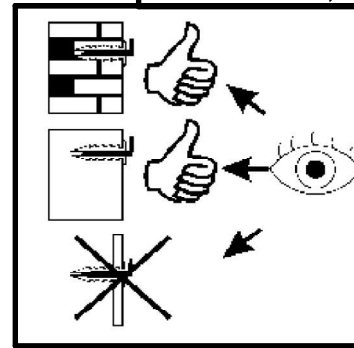
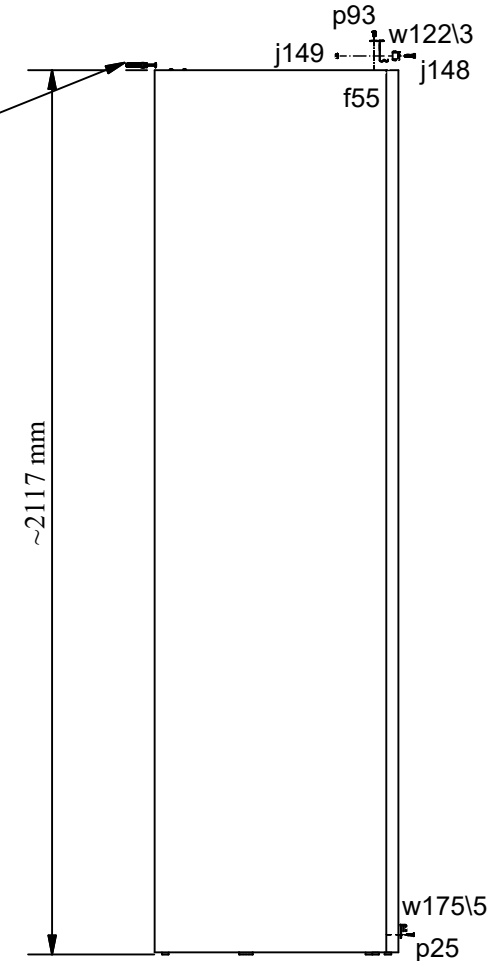
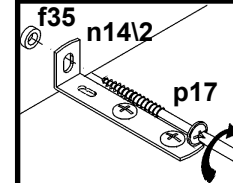
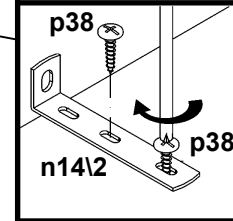
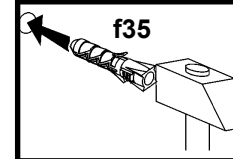
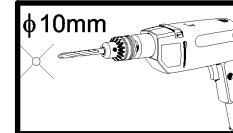
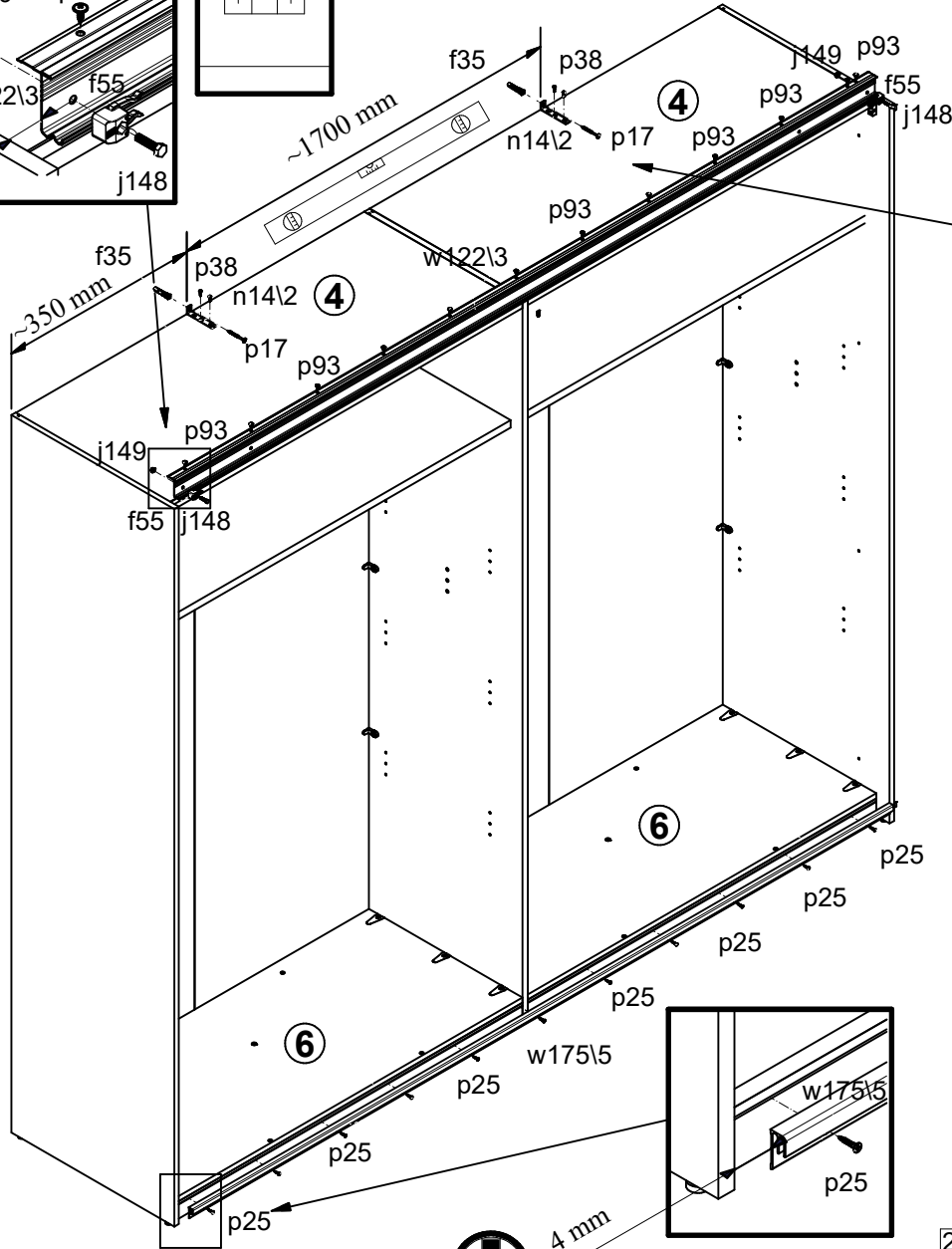
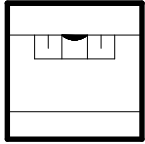
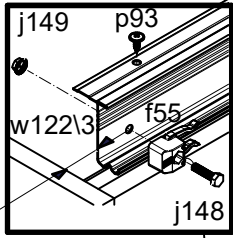

4 mm

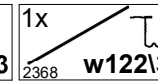
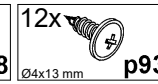
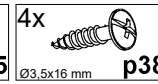
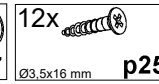
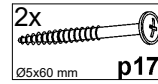
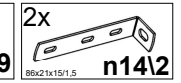
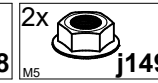
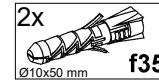

6

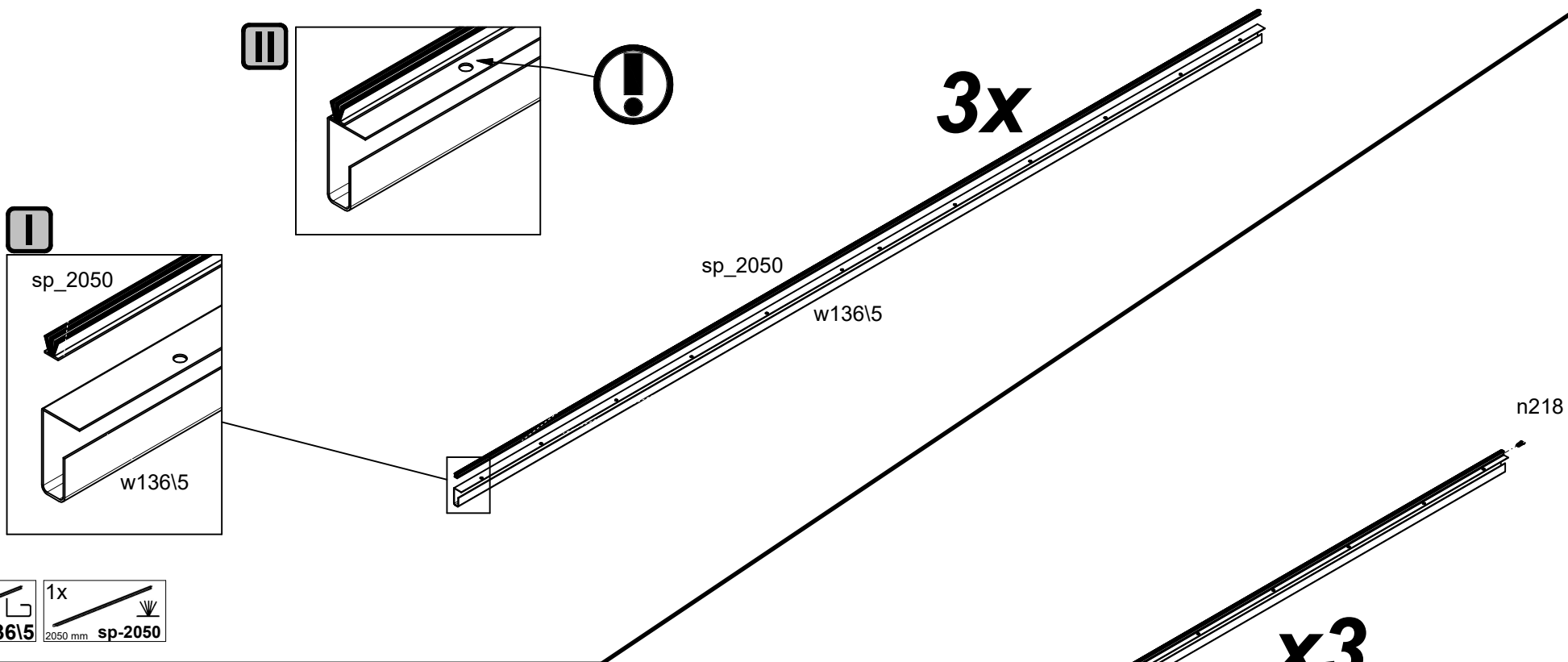

7

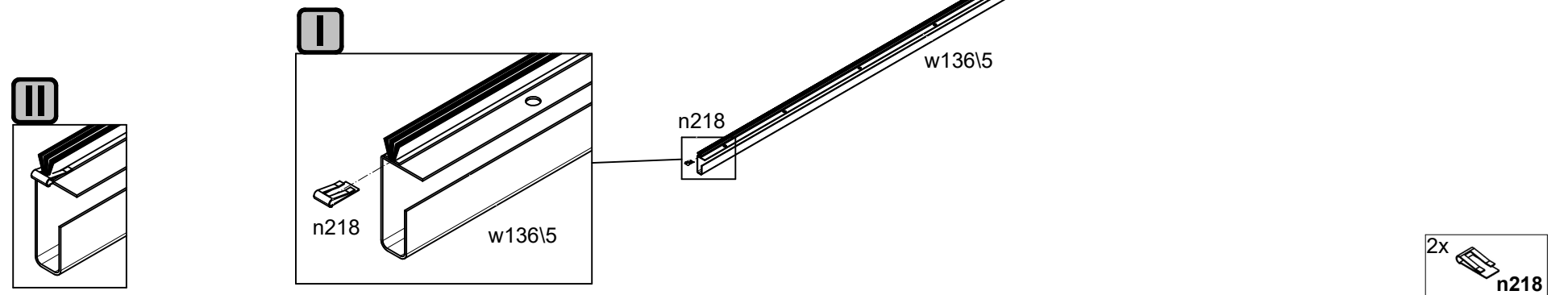

8



L

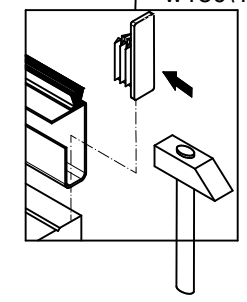
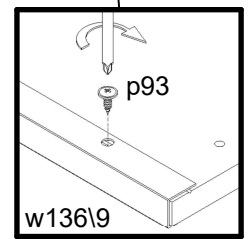
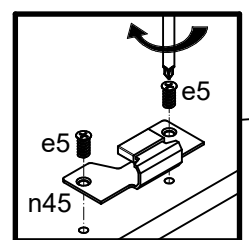
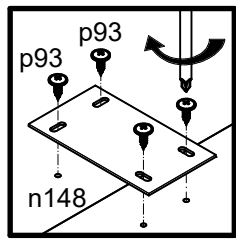
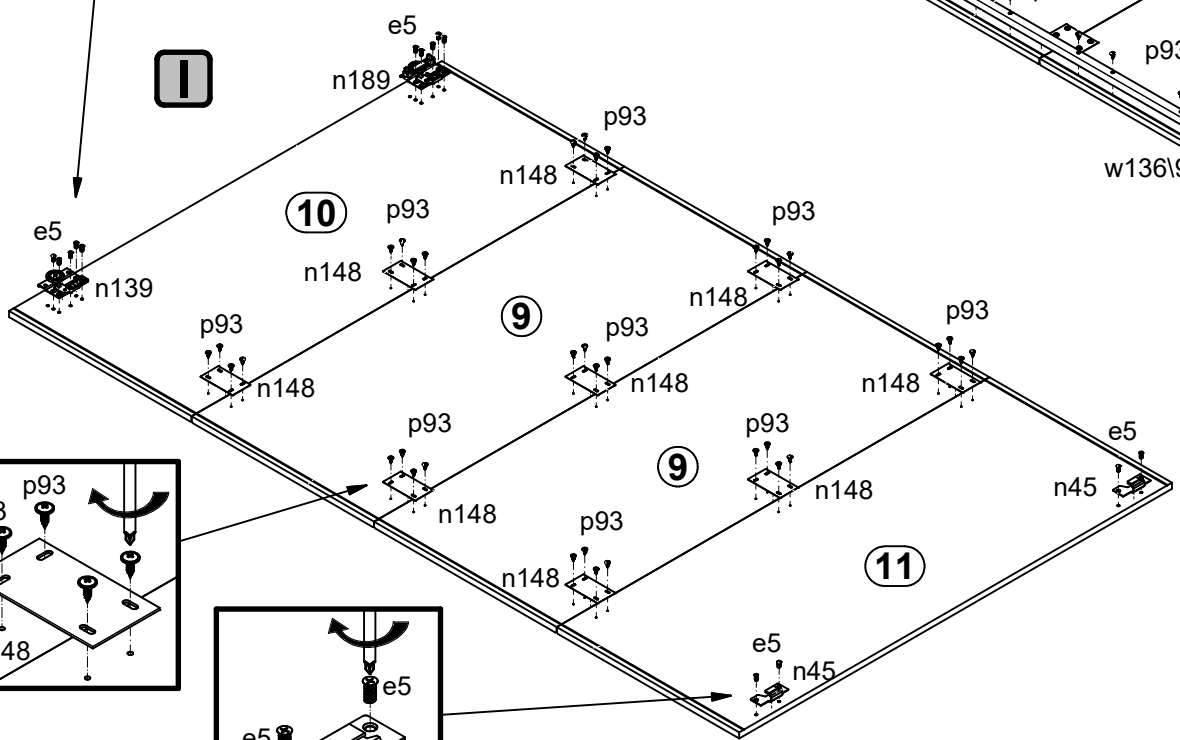
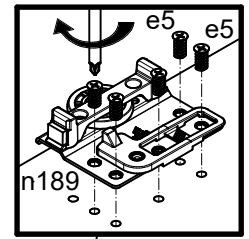
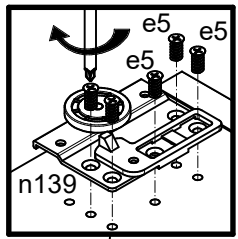
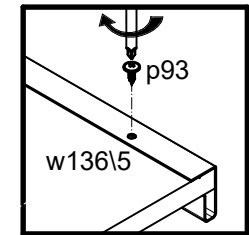

14x Ø6.3x13 mm e5	2x n45
1x n139	9x 90x50x1.5 mm n148
1x n189	60x Ø4x13 mm p93
1x w180\1	1x 2050 mm w136\5
	1x 2050mm w136\9

9



R

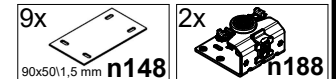
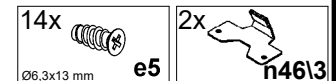
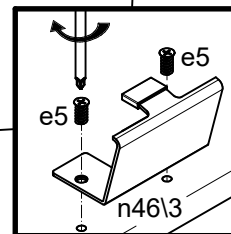
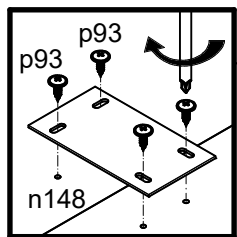
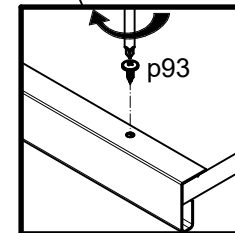
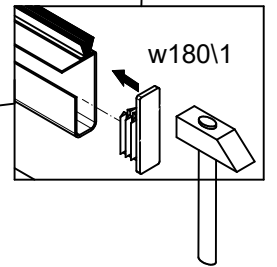
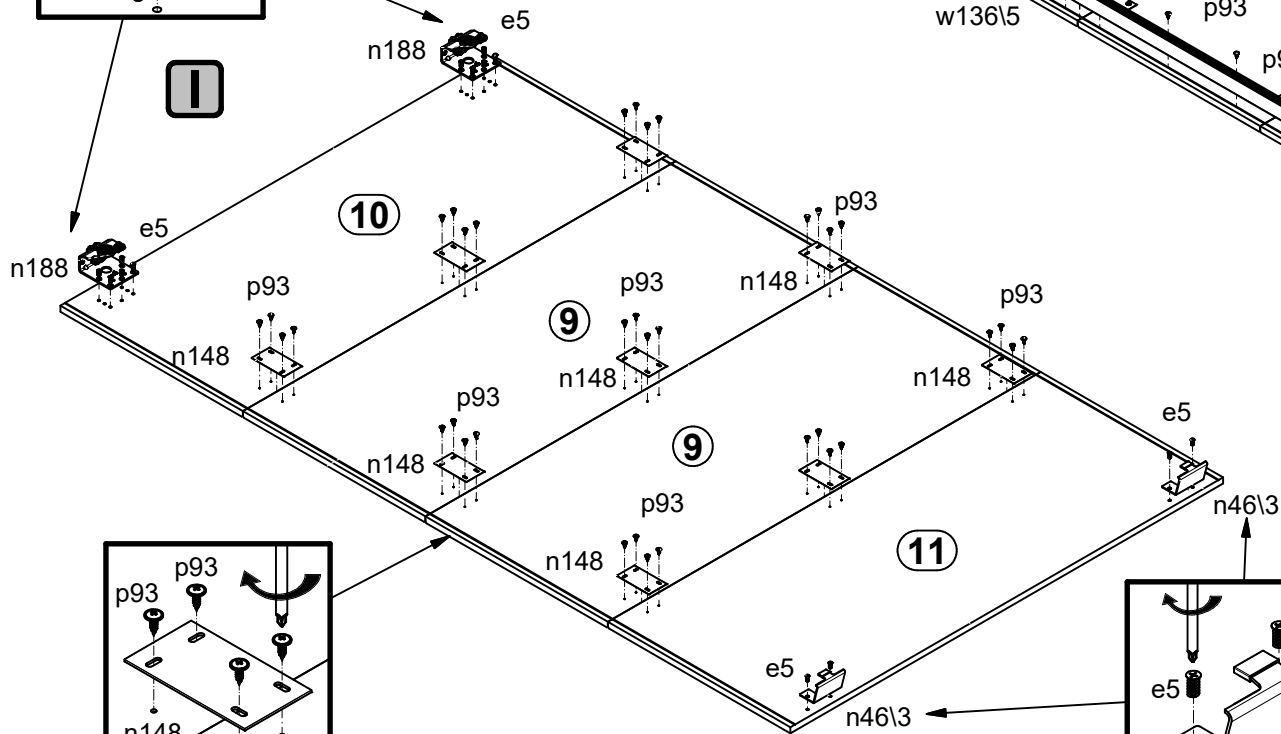
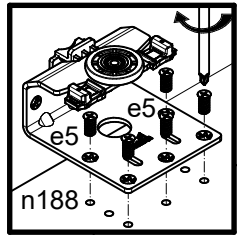
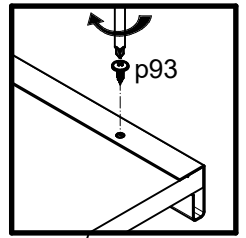

10

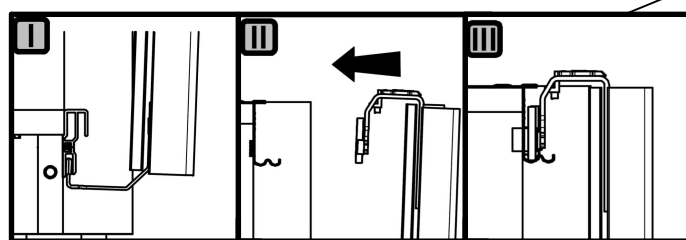
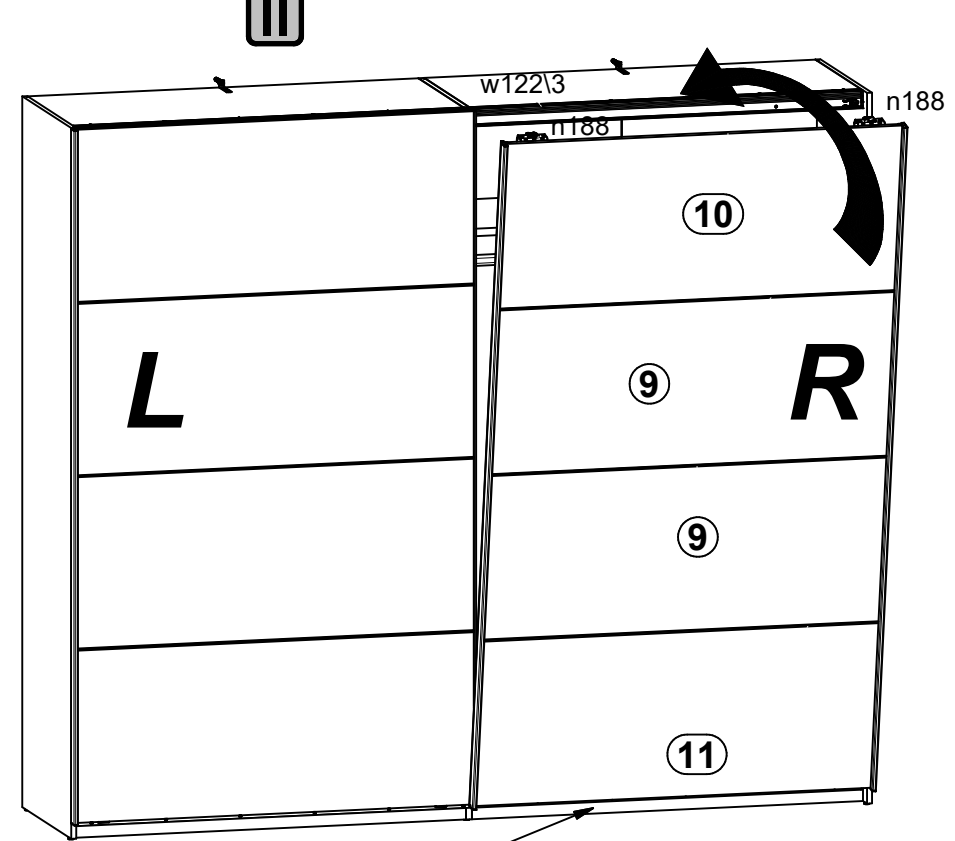
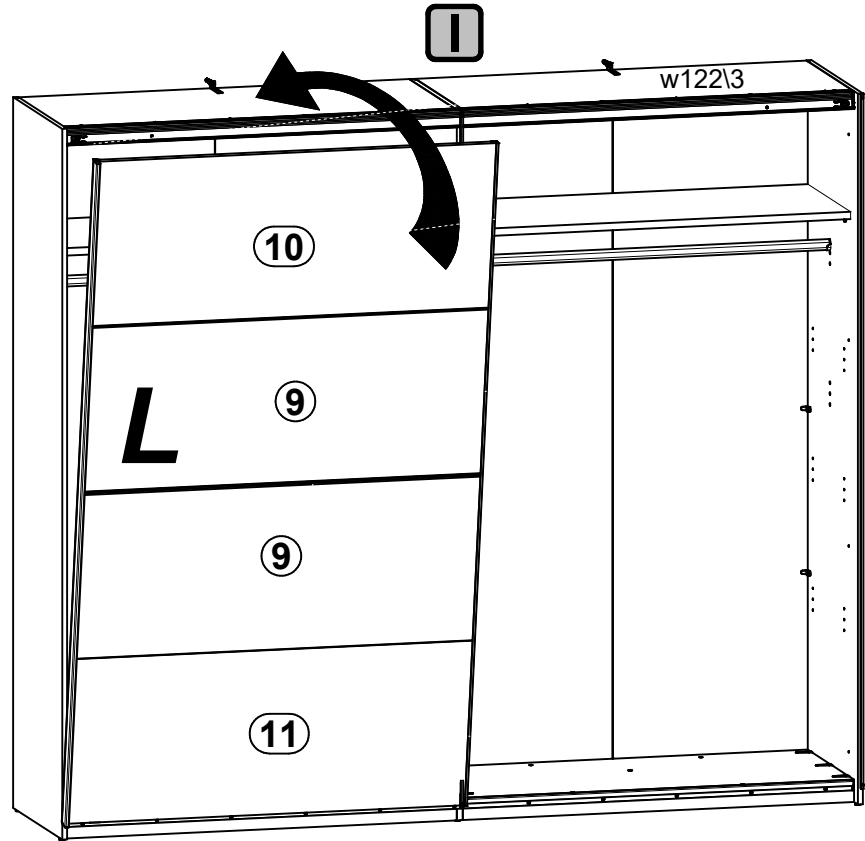
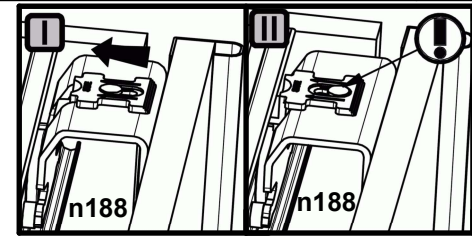
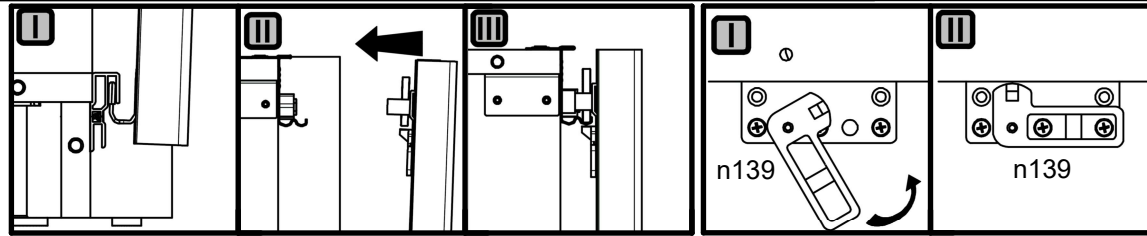

11

