

Restrictions

- This product is designed for indoor floor cleaning only, Please do not use it outdoors (such as an open-ended terrace), on any surface instead of the ground (such as a sofa), or in a commercial or industrial environment
- Please do not use the product on any elevated surface without barriers (such as the floor of a loft, an open-ended terrace and the surface of furniture)
- Please do not use the product when the temperature is higher than 40°C or lower than 4°C, or there is any liquid or sticky substance on the floor
- Before using the product, please put aside wires on the floor to avoid them being dragged around when the cleaner is working
- To prevent the cleaner from being blocked whilst it is working and your valuables from any damage from slight crashes. please clean up fragile objects and odds and ends on the floor before switching on the cleaner (such as vases and plastic bags)
- Children should be supervised to ensure that they do not play with the appliance
- This appliance is not intended for use by persons (including children) with reduced physical, sensory or mental capabilities, or lack of experience and knowledge, unless they have been given supervision or instruction concerning use of the appliance by a person responsible for their safety (CB)

- This appliance can be used by children aged from 8 years and above and persons with reduced physical, sensory or mental capabilities or lack of experience and knowledge if they have been given supervision or instruction concerning use of the appliance in a safe way and understand the hazards involved. Children shall not play with the appliance. Cleaning and user maintenance shall not be made by children without supervision (EU)
- Please keep the main brush cleaning tools out of reach of children
- Do not place any object (including children and pets) on the cleaner, no matter whether it is working or not
- Keep hair, loose clothing, fingers, and all parts of body away from openings and moving parts
- Do not use the cleaner on any burning object (such as a burning cigarette butt)
- Do not use the cleaner on plush carpets (the cleaner might not work well on some dark-colored carpets either)
- Do not use the cleaner to clean hard or sharp objects (such as decoration wastes, glass and nails)
- Do not carry the cleaner by the cap on the distance laser sensor, the cover on the main unit or the collision buffer

- The appliance must be switched off and the plug must be removed from socket-outlet before cleaning or maintaining the appliance
- Do not use a wet piece of cloth or any liquid to clean any part of the product
- Do not use the mopping module on carpets
- Please use the product according to the manual. Any loss or damage caused from improper use will be borne by the user

Battery and Charging

WARNING

- For the purposes of recharging the battery, only use the detachable supply Unit roborock CDZ02RR or CDZ06RR provided with this appliance
- Do not arbitrarily dismantle, repair or modify the battery or dock charger
- Please keep the dock charger away from heat (such as heating plates)
- The battery must be removed from the appliance before it is scrapped
- The appliance must be disconnected from the supply mains when removing the battery
- The battery is to be disposed of safely. Please do not discard waste batteries. Leave them to a professional recycling organization
- Do not wipe or clean the chargers shrapnel with a piece of wet cloth or wet hands

- If the supply cord is damaged, it must be replaced by the manufacturer, its service agent or similarly qualified persons in order to avoid a hazard
- Please make sure the cleaner is powered off in shipment and original packaging is advised
- If left unused for a long period, please store the cleaner in a cool and dry place after having it fully charged and switched off, charge it at least every three months to avoid the battery being over discharged

Table of Faults of Robotic Vacuum Cleaner

Table of Faults of Robotic Vacuum Cleaner	
Item	Faults
Main Unit	Failure of the functions given in the manual
	Failure of power on
	Malfunction of the main brush, the side brush, the fan or the main wheel
Dock Charger	Failure of charging the main unit
Power cable	Failure of supply electricity to the dock charger

Main Unit

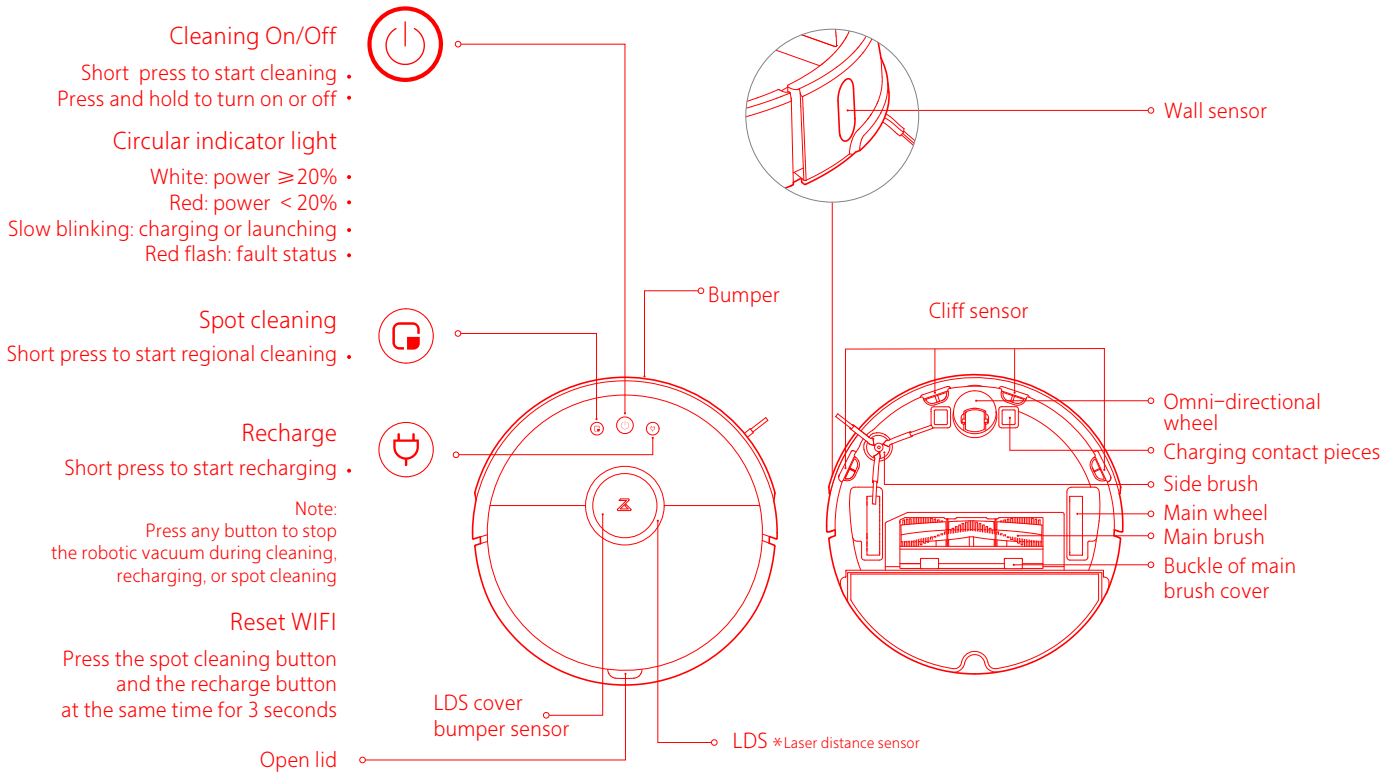

Dust Bin

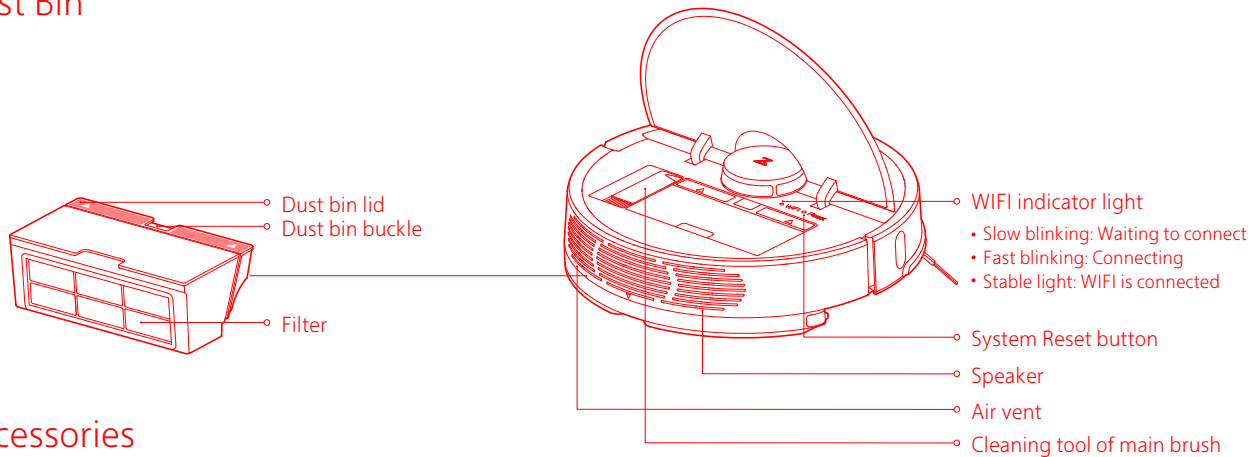

Accessories



Water tank

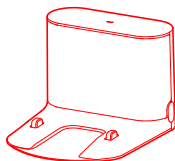

Dock charger

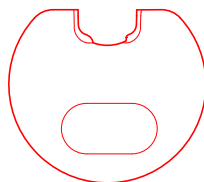

Moistureproof mat



Mopping cloth

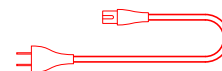

Power cable

- 1 Plug the dock charger into the interface of the moistureproof mat, and make sure it's firmly installed.

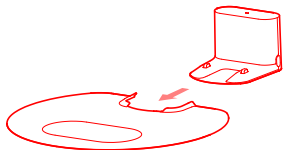

- This moistureproof mat can keep the floor dry

- 2 Keep the dock charger on a level surface, flat against a wall, plug into power outlet.

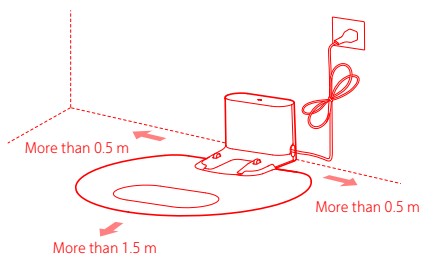

Note:

- Ensure to leave enough space to the dock charger (0.5 meters on both sides, more than 1.5 meters in the front).
- It will cause unexpected power outages and/or dock charger displacement if the power cable is dragged by main unit accidentally due to disorganized placed.
- The dock charger indicator is on after it's plugged into power outlet, the indicator is off when main unit is being charged.

- 3 Turn on and charge the machine

Press and hold the button  to turn on the main unit ,wait until the indicator light is on for a while ,then place the main unit on the dock charger to charge.

The machine is equipped with a built-in high performance lithium-ion rechargeable battery pack. To maintain battery performance, please keep the machine charged for normal use.

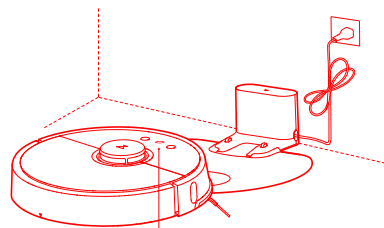

The color of the circular light indicator refers to the quantity of electricity

- White: power $\geq 20\%$
- Red: power $< 20\%$

Note: Robotic vacuum cleaner may not be powered on when battery is low, connect the robotic vacuum cleaner to the dock charger.

- 4 Connect to the mobile phone client

The product is compatible with Mi Home intelligent platform and could be controlled by Mi Home app. It supports the MIUI system and can be interconnected with other Mi Home intelligent products

Quick Setup

- ① Download App
Search "Mi Home" in App store/Google play or scan the QR code below to download and install the Mi Home app.

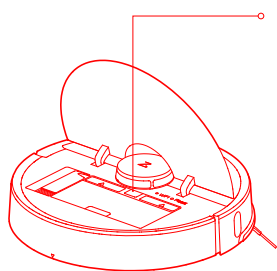

WiFi indicator light

- Slow blinking: Waiting to connect
- Fast blinking: Connecting
- Stable light: WiFi is connected





Scan to download the APP

② Add Device

Go to "My Device" page of Mi Home app and tap "+" on the top right corner of the page to add a device. You could find newly added device on "My Device" list

③ Reset WIFI

If anything is wrong with WIFI connection, you could try to reset WIFI to default.

Open upper cover to check the WIFI indicator status next to reset button. Press and hold the  key and  key until you hear the voice "Reset WIFI". The resetting is completed when the WIFI indicator starts to flash slowly and the cleaner will enter a pending connection state.

5 Install the mopping module

① Install the mopping cloth:

Wet the mopping cloth and wring it until it doesn't drip.

Insert it into the bottom along the slot of the water tank and stick it firmly.

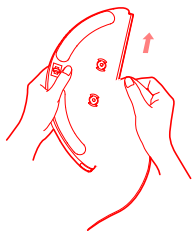

② Fill the water tank: Open the tank lid, fill it with water, and put back the tank lid.

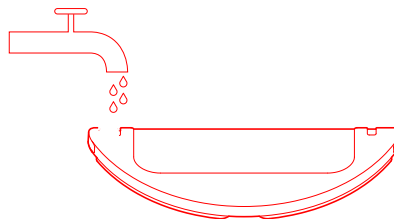

③ Install the module: Push in the module along the bottom of the main unit and follow the alignment mark on the mopping module. A click sound means it is installed properly.

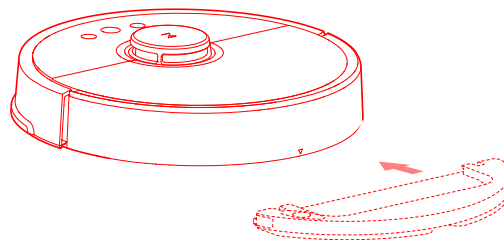

Note: In order to achieve a better mopping effect, it is recommended to use the main unit to clean the floor three times before install the mopping module.

6 Start cleaning

When the circular indicator light on the main unit changes from slow blinking to stable, it means charging has completed. Briefly press button  or start cleaning through the mobile phone client.

7 Remove the mopping module

When the main unit is back on the dock charger after cleaning, press the buckles on both sides by hand, drag and remove the mopping module.

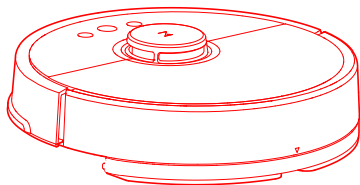

Note:

- Please use moistureproof mat if you put the dock charger on wood floor
- Remove tank when charging or not in use

Main brush * Clean it every week as recommended

1. Turn over the machine, press the buckle and take off the cover.
2. Take out the main brush in an upwards movement and clean the bearing of the main brush.
3. Use the matching cleaning tool of the main brush to cut off the hairs entangled on the main brush.
4. Install the main brush, press tight the cover and fix the buckle.

Note: It is recommended to replace the main brush every 6-12 months so as to ensure it cleans effectively.

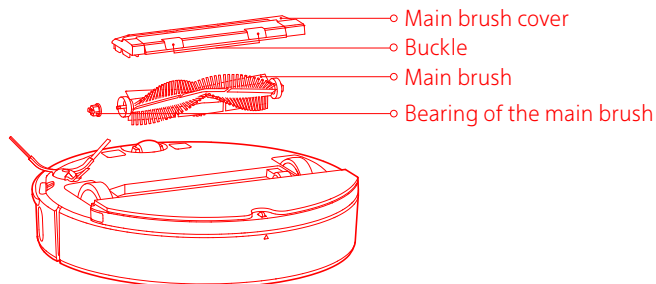

Instruction for using the cleaning tool of the main brush

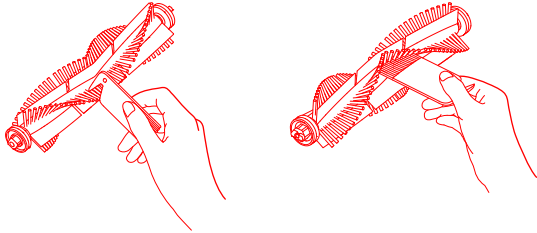

Pour the water into the dust bin, close the dust bin cover, shake the dust bin left and right, pour out the dirty water, repeat this step several times, until the filter clean.

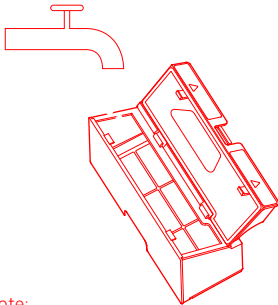

Note:

- Wash the filter by water only, detergents are not allowed to use.
- Please do not use finger or brush to clean the filter to avoid any possible damage.
- Please dry out the filter at least for 24 hours after washing.

Change of filter

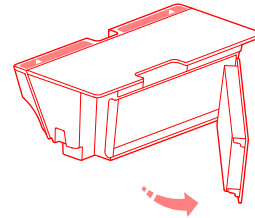

Please remove the filter and replace it as shown in the picture.

Water tank filter element component

* It is recommended to replace it every 1-3 months

1. Use your finger to remove the two filter element component from the gap.
2. Fit the new filter element and make sure it is in the right place .

Note: It is recommended to replace the filter element component every 1-3 months so as to ensure effective cleaning

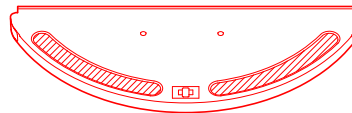

Main Unit Sensor

Wipe the sensors of the main unit with a soft, dry cloth, including:

1. The four cliff sensors at the bottom of the main unit.
2. The wall sensor on the right side of the main unit.
3. The charging contact pieces at the bottom of the main unit.

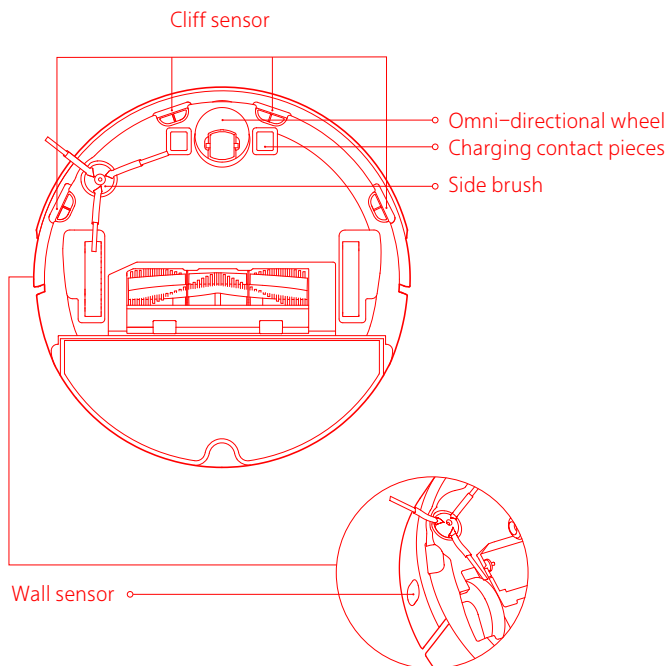

Omni-directional wheel

* It is recommended to clean it every month

1. Turn over the machine and take out the omni-directional wheel by pulling upwards.
2. Clean the hair and dirt off the wheel and the axle.
3. Install the wheel and press it tight.

Note: You may rinse it with tap water and install it after it gets dry

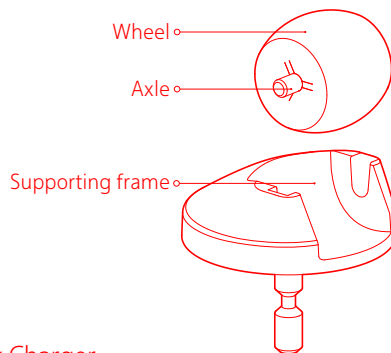

Dock Charger

* It is recommended to clean it every month.

Wipe the battery connectors of the dock charger with a soft, dry cloth.

Restore Factory Settings

If the machine does not function properly after resetting, please hold the button  when the machine is on, and press the rest button at the same time, until you hear the voice prompt "start restoring the initial version", then the main unit has been restored to the factory settings.

Main Unit

Item	Parameters
Size	353 × 350 × 96.5mm
Battery	Lithium-ion battery 14.4V/5200mAh
Weight	3.5kg
Wireless	Smart connect
Rated Voltage	14.4VDC
Rated Power	58W

Dock Charger

Item	Parameters
Size	151 × 130 × 98mm
Rated Power	42W
Rated Input	100-240VAC
Rated Output	20VDC 1.8A
Rated Frequency	50-60Hz

Hereby we:

Name of manufacturer	Beijing Roborock Technology Co.,Ltd.
Address	Floor6,Suite6016,6017,6018,BuildingC,Kangjian Baosheng Plaza, No.8 Heiquan Road,Haidian District, Beijing,P.R.CHINA

declare that this DoC is issued under our sole responsibility and that the products:

Product description	Robotic Vacuum Cleaner and Accessories
Type(model) designation(s)	S5 ***** (* can be 0 to 9, A to Z, a to z, "-", "_", "\", "/" or blank,for marketing purpose.)

are in conformity and verified through testing with the provision of the following EU directives:

<p>RED Directive 2014/53/EU Article 3.1 a): Safety&Health</p> <ol style="list-style-type: none"> 1. EN 60335-1:2012 + A11:2014 + AC:2014 + A13:2017 2. EN 60335-2-2:2010 + A11:2012 + A1:2013 3. 1999/519/EC 4. EN 62311:2008 5. EN 62233:2008 	<ol style="list-style-type: none"> 1. Household and similar electrical appliances-Safety-Part 1: General requirements 2. Household and similar electrical appliances-Safety-Part 2-2: Particular requirements for vacuum cleaners and water suction cleaning appliance 3. COUNCIL RECOMMENDATION of 12 July 1999 on the limitation of exposure of the general public to electromagnetic fields (0 Hz to 300 GHz) 4. Assessment of electronic and electrical equipment related to human exposure restrictions for electromagnetic fields (0 Hz – 300 GHz) 5. Measurement methods for electromagnetic fields of household appliance and similar apparatus with regard to human exposure
---	--

<p>RED Directive 2014/53/EU Article 3.1 b): EMC</p> <ol style="list-style-type: none"> 1. Draft EN 301 489-1 V2.2.0 2. Draft EN 301 489-17 V3.2.0 3. EN 55014-1:2017 4. EN 55014-2: 2015 5. EN 61000-3-2: 2014 6. EN 61000-3-3: 2013 	<ol style="list-style-type: none"> 1. Electromagnetic Compatibility (EMC) standard for radio equipment and services; Part 1: Common technical requirements; Harmonized Standard covering the essential requirements of article 3.1(b) of Directive 2014/53/EU and the essential requirements of article 6 of Directive 2014/30/EU 2. Electromagnetic Compatibility (EMC) standard for radio equipment and services; Part 17: Specific conditions for Broadband Data Transmission Systems; Harmonized Standard covering the essential requirements of article 3.1(b) of Directive 2014/53/EU 3. Electromagnetic Compatibility-Requirements for household appliances, electric tools and similar apparatus Part 1: Emission 4. Electromagnetic compatibility – Requirements for household appliances, electric tools and similar apparatus Part 2: Immunity – Product family standard 5. Electromagnetic compatibility (EMC) – Part 3-2: Limits – Limits for harmonic current emissions (equipment input current ≤ 16 A per phase). 6. Electromagnetic compatibility (EMC) – Part 3-3: Limits – Limitation of voltage changes, voltage fluctuations and flicker in public low-voltage supply systems, for equipment with rated current ≤ 16 A per phase and not subject to conditional connection.
<p>RED Directive 2014/53/EU Article 3.2: Radio Spectrum EN 300 328 V2.1.1</p>	<p>Wideband transmission systems; Data transmission equipment operating in the 2,4 GHz ISM band and using wide band modulation techniques; Harmonized Standard covering the essential requirements of article 3.2 of Directive 2014/53/EU</p>
<p>ROHS Directive 2011/65/EU EN50581:2012</p>	<p>Technical documentation for the assessment of electrical and electronic products with respect to the restriction of hazardous substances</p>

Product description	Dock Charger and Accessories
Type(model) designation(s)	Dock Charger, models: CDZ02RR or CDZ06RR.

are in conformity and verified through testing with the provision of the following EU directives:

<p>Low Voltage Directive 2014/35/EU</p> <ol style="list-style-type: none"> 1. EN 60335-1:2012 + A11:2014 2. EN 60335-2-29:2004 + A2:2009 3. EN 62233:2008 	<ol style="list-style-type: none"> 1. Household and similar electrical appliances–Safety–Part 1: General requirements 2. Household and similar electrical appliances–Safety–Part 2-29: Particular requirements for battery chargers 3. Measurement methods for electromagnetic fields of household appliance and similar apparatus with regard to human exposure
<p>EMC Directive 2014/30/EU</p> <ol style="list-style-type: none"> 1. EN 55014-1:2017 2. EN 55014-2: 2015 3. EN 61000-3-2: 2014 4. EN 61000-3-3: 2013 	<ol style="list-style-type: none"> 1. Electromagnetic Compatibility–Requirements for household appliances, electric tools and similar apparatus Part 1: Emission 2. Electromagnetic compatibility – Requirements for household appliances, electric tools and similar apparatus Part 2: Immunity – Product family standard 3. Electromagnetic compatibility (EMC) – Part 3-2: Limits – Limits for harmonic current emissions (equipment input current ≤ 16 A per phase). 4. Electromagnetic compatibility (EMC) – Part 3-3: Limits – Limitation of voltage changes, voltage fluctuations and flicker in public low-voltage supply systems, for equipment with rated current ≤ 16 A per phase
<p>ROHS Directive 2011/65/EU EN50581:2012</p>	<p>Technical documentation for the assessment of electrical and electronic products with respect to the restriction of hazardous substances</p>

Person responsible for making this declaration:

Printed name: Rui.Shen

Position/Title: Quality Director

Signature: 

Date of issue: Jun 14, 2018

Correct Disposal of this product . This marking indicates that this product should not be disposed with other household wastes throughout the EU. To prevent possible harm to the environment or human health from uncontrolled waste disposal, recycle it responsibly to promote the sustainable reuse of material resources. To return your used device, please use the return and collection systems or contact the retailer where the product was purchased. They can take this product for environmental safe recycling.

Korrekte Entsorgung dieses Produkts Innerhalb der EU weist dieses Symbol darauf hin, dass dieses Produkt nicht über den Hausmüll entsorgt werden darf. Altgeräte enthalten wertvolle recyclingfähige Materialien, die einer Wiederverwertung zugeführt werden sollten und um der Umwelt bzw. der menschlichen Gesundheit nicht durch unkontrollierte Müllbeseitigung zu schaden. Bitte entsorgen Sie Altgeräte deshalb über geeignete Sammelsysteme oder senden Sie das Gerät zur Entsorgung an die Stelle, bei der Sie es gekauft haben. Diese wird dann das Gerät der stofflichen Verwertung zuführen.



Warranty Information

The seller provides warranty in accordance with the legislation of the customer's own country of residence, with a minimum of 1 year, starting from the date on which the appliance is sold to the end user.

The warranty only covers defects in material or workmanship.

The repairs under warranty may only be carried out by an authorized service centre. When making a claim under the warranty, the original bill of purchase (with purchase date) must be submitted.

The warranty will not apply in cases of:

Normal wear and tear

Incorrect use, e.g. overloading of the appliance, use of non-approved accessories Use of force, damage caused by external influences Damage caused by non-observance of the user manual, e.g. connection to an unsuitable mains supply or non-compliance with the installation instructions

Partially or completely dismantled appliances

Laser Safety

The laser distance sensor of this product meets the standards for Class I Laser Products in IEC 60825-1:2014 and will not generate hazardous laser radiation



Robotic Vacuum Cleaner

Manufacturer: Beijing Roborock Technology Co., Ltd.

Product Model: S5*****(*can be 0 to 9, A to Z, a to z, "-", "_", "\", "/" or blank, for marketing purpose.)

Address of Manufacturer: Floor 6, Suite 6016, 6017, 6018, Building C, Kangjian Baosheng Plaza,
No. 8 Heiquan Road, Haidian District, Beijing, P.R. CHINA

For more product information, please visit our website: www.roborock.com

For after-sales support, please email our after-sales service team:

US/Non-Europe Support: support@roborock.com

Europe Support: support@roborock-eu.com