

EKSA

E1000_{WT}

Wireless Gaming Headset



User Manual



Language Guide

English 1

日本語 10

Français 19

Deutsch 28

Русский 37

Español 46

Italiano 55

Português 64

Türkçe 73



Package Contents

- ① EKSA E1000 WT Wireless Gaming Headset
- ② 3.5 mm Audio Cable
- ③ Type C Charging Cable
- ④ USB Dongle
- ⑤ Carry Pouch
- ⑥ User Manual

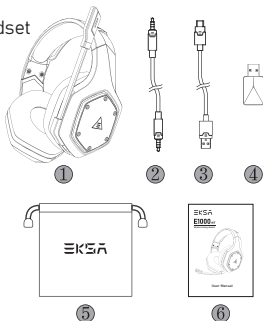

Specifications



Size: 50 mm
 Unit impedance (Ω): 32 Ω
 Frequency Range: 20 Hz - 20 kHz
 Sensitivity (dB/mW) : 105 \pm 3 dB



Type: Lithium Battery
 Use Time: Up to 36 hours (light off)
 Rated Power: 5 V $\bar{\bar{=}}$ 1 A
 Charging Time: 2.5 H



Type: Condenser Mic
 Polar Pattern: Omnidirectional
 Sensitivity: -42 \pm 3 dB
 Impedance: 2.2 K Ω



Product Overview

- ① Head Cushion
- ② Length Adjustment
- ③ Colorful RGB Lights
- ④ Rotable Microphone
- ⑤ Ear Cushions
- ⑥ USB 2.4G Dongle
- ⑦ 3.5 mm to 3.5 mm Audio Cable
- ⑧ Volume Adjuster
- ⑨ Mic Mute Button / ENC Button
- ⑩ Power On / Off Button / Multifunctional Button
- ⑪ Status Indicator
- ⑫ 3.5 mm Wired Mode port
- ⑬ Charging Indicator
- ⑭ Type-C Charging Port

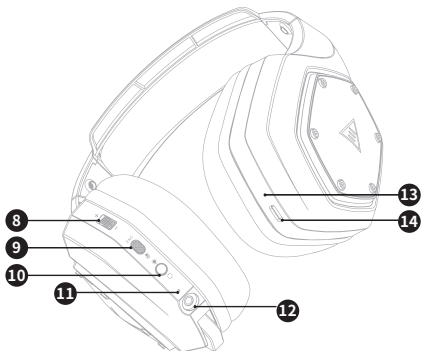
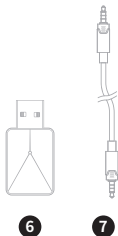
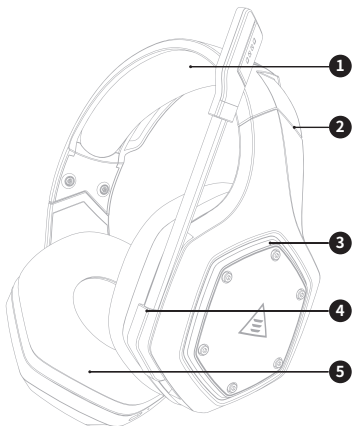



Operation Guide



Volume Control Wheel:



Scroll upward: Volume +



Scroll downward: Volume -



Mic Button:

ENC



Press for 3 seconds: ENC on / off



Click: Microphone on / off



Power Button:



Press for 3 seconds: Power on / off



Click: Surround Sound on / off



Double-click: Light on / off

Wired Mode:

When the 3.5 mm audio cable plugs in, the headset will turn off automatically. Only the volume control works while all the other buttons don't.



Main Features

1. EKSA VoicePure ENC

Perfect your game communication with EKSA VoicePure ENC. It isolates your voice from the noise around you with a noise-cancelling microphone, eliminating up to 96% of distracting background noise. You'll sound natural and clear in-game chats, giving you an extra competitive edge.

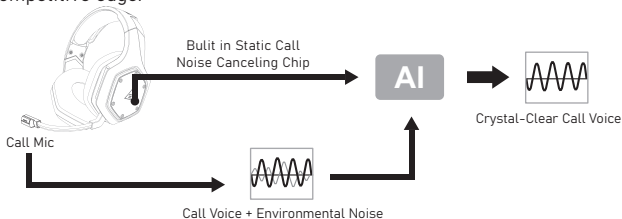

2. EKSA 7.1 SoundBase

EKSA 7.1 SoundBase provides an unrivaled audio experience with punchy and immersive sound. Every sneaky footstep and every explosive gunshot is reproduced with accurate positioning and stunning clarity, creating a lifelike battlefield. The plug-and-play feature means no extra hassle to get a truly immersive gaming experience across platforms - including PS®4, PS®5, Switch™, and PC. To customize your preferred sound effects, simply download the driver from our official website(<https://www.eksa.net/download>).

Note: EKSA SoundBase Software supports Windows® only.

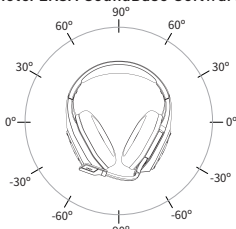

2.1

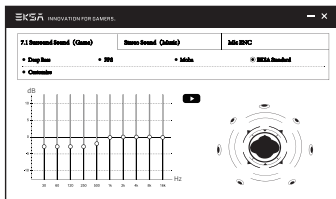

2.2



Main Features

3. Wide Compatibility

Equipped with 3.5 mm audio cable and USB Dongle, compatible with PS®5, PS®4, Xbox® One, Nintendo Switch™, PC, Laptop, Mac, mobile devices, etc.

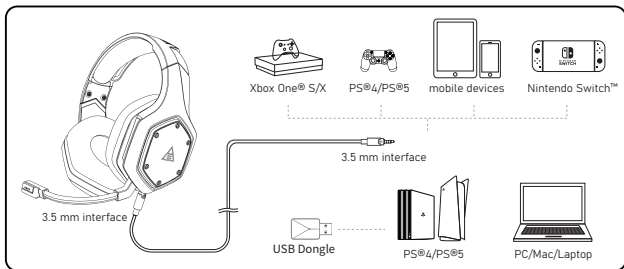

4. One Key Sound Mode Switch

This button is on the ear shell, allowing you to switch from 7.1 surround sound to game mode or stereo to music mode. It is straightforward and convenient to operate.

Note: when switching the sound mode, you will hear a “surround sound on / off” voice prompt.

Sound Mode Switch Button

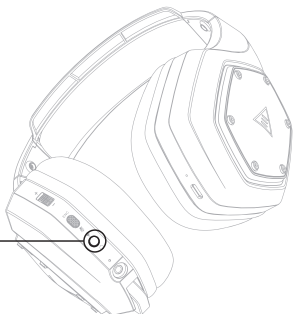



USB Dongle Settings

Follow the steps below to ensure your EKSA E1000 WT headset is the default audio device.

Windows®:

Audio Settings:



[Control Panel] ↓
[Hardware and Sound] ↓
[Sound] ↓
[Playback] ↓
[EKSA E1000 WT (Set as Default Device)]



Microphone Settings:

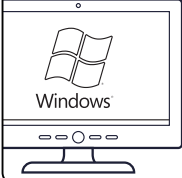



[Control Panel] ↓
[Hardware and Sound] ↓
[Sound] ↓
[Recording] ↓
[EKSA E1000 WT (Set as Default Device)]



macOS:



[System Preferences] → [Sound] 
 [Input] → [EKSA E1000 WT]
[Output] → [EKSA E1000 WT]





How to Use

PlayStation® 4 / PlayStation® 5:

Connect the USB Dongle or the 3.5 mm audio cable with your PS®4/PS®5 . Then follow the steps below to check the audio settings to ensure your PS®4/PS®5 automatically switch to play audio and turn on microphone.

PS®4

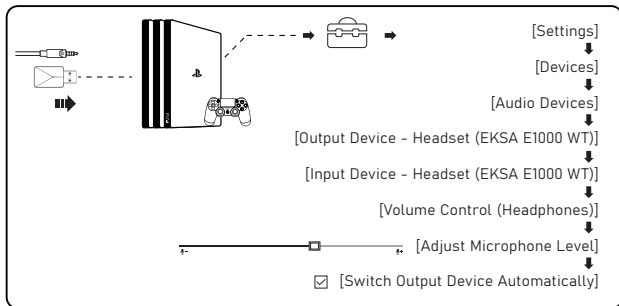

PS®5

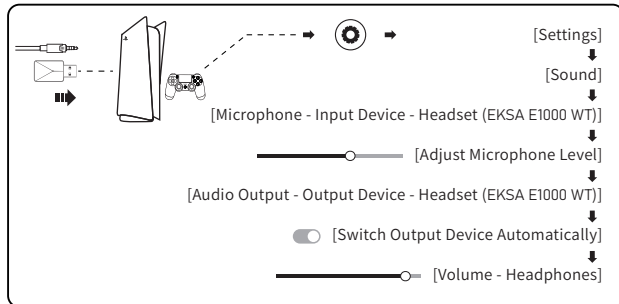



How to Use

Xbox One® S/X:

To work on the NEW version of the Xbox One® S/X controller, you can directly connect your headset to the controller via the 3.5 mm audio cable.

Notes: 1. The headset is not compatible with Xbox®360.

2. Old version of Xbox® One needs a Microsoft adapter (not included).

Guide for Xbox® Users

The controller has a 3.5 mm jack:
no adapter is required



Xbox One® S/X controller

The controller doesn't have a 3.5 mm jack:
a Microsoft adapter is required
(not included)

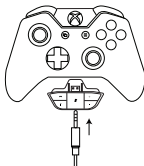

Xbox® One controller (old version)



FAQ

Q1: My headset has no sound.

- A:**(1) First, ensure you've plugged the headset correctly into your device. If that doesn't work, check your audio settings to ensure that you enable your speakers and don't mute your device, then check the volume of your device and headphone to ensure it is at a proper level.
- (2) Unplug the USB transmitter or the 3.5 mm audio cable and replug it in; wipe the dirt or dust on the USB transmitter or the 3.5 mm Interface; reconnect the headset to the device and check if the microphone works.
- (3) If the USB transmitter is flashing blue light quickly, keep the transmitter where it is, and turn off your headset, then press the power button for 6 seconds. Don't release your finger until hearing a voice notice of "pairing", which means the pairing is successful now.

Q2: After I have connected the headset with my computer, I can't use its microphone.

- A:**(1) Go to control panel>Sound>Input. Choose the headset's microphone as the default mic.
- (2) Check the microphone of the headset isn't mute.

Q3: People on the other side can't hear me.

- A:** (1) Check the microphone of the headset isn't mute.
- (2) Check the audio and ensure that your headset is the default device. Please refer to page 6 and 7 for more specific information for sound settings.
- (3) Ensure that your device is compatible with the headset. EKSA E1000 WT headset isn't compatible with Xbox®360 and the old version of Xbox®One requires an extra microsoft adapter (not included).
- (4) If all these have been checked and the headset is compatible with the device while the microphone still doesn't work, please contact us (info@eksa.net).



梱包リスト

- ① EKSA E1000 WT ワイヤレスゲーミングヘッドセット
- ② 3.5 mm オーディオケーブル
- ③ タイプC充電ケーブル
- ④ USB Dongle
- ⑤ キャリーポーチ
- ⑥ ユーザーマニュアル

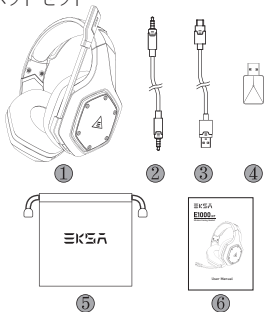

スペック



サイズ: 50 mm
 単位インピーダンス(Ω): 32 Ω
 周波数帯域: 20 Hz - 20 kHz
 感度 (dB/mW): 105 \pm 3 dB



タイプ: リチウム電池
 使用時間: 最大36時間 (消灯時)
 定格電力: 5V \equiv 1A
 充電時間: 2.5 H



タイプ: コンデンサーマイク
 ポーラーパターン: 無指向性
 感度: -42 \pm 3 dB
 インピーダンス: 2.2 K Ω



製品概要

- ① ヘッドクッション
- ② 長さ調整
- ③ カラフルなRGBライト
- ④ 回転式マイク
- ⑤ 耳あてクッション
- ⑥ USB 2.4Gドングル
- ⑦ 3.5 mm～3.5 mmオーディオケーブル
- ⑧ ボリュームアジャスター
- ⑨ マイクミュート ボタン / ENC ボタン
- ⑩ 電源オン/オフボタン/多機能ボタン
- ⑪ 状態表示
- ⑫ 3.5 mm 有線モードインターフェース
- ⑬ 充電インジケータ
- ⑭ タイプC充電ポート

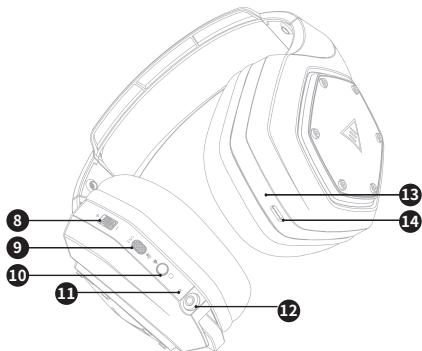
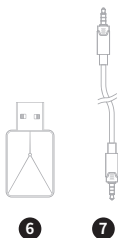
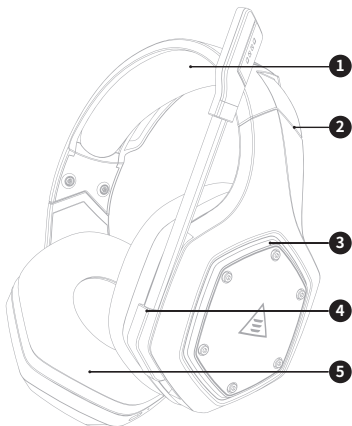



操作ガイド



ボリュームコントロールホイール:



上にスクロール: 音量 +



下にスクロール: 音量 -



マイクボタン:

ENC



3秒間押す: ENCオン/オフ



クリック: マイクのオン/オフ



電源ボタン:



3秒間押す: 電源オン/オフ



クリック: サラウンドサウンドのオン/オフ



ダブルクリック: ライトオン/オフ

有線モード:

3.5 mm オーディオケーブルが接続されると、ヘッドセットは自動的にオフになります。ボリュームコントロールのみ動作し、他のボタンは動作しません。



主な特徴

1. EKSA VoicePure ENC

EKSA VoicePure ENCでゲームのコミュニケーションは完璧です。ノイズキャンセリングマイクで周囲の騒音から声を分離し、気になる騒音を最大96%除去します。ゲーム中のチャットも自然でクリアなサウンドで、より競争力を高めることができます。

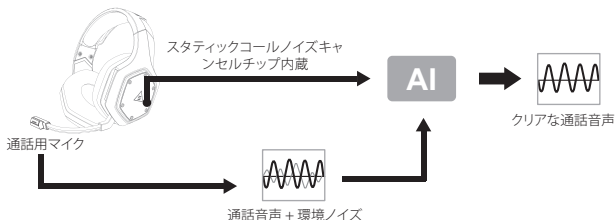

2. EKSA 7.1 SoundBase

EKSA 7.1 SoundBaseは、パンチの効いた臨場感溢れるサウンドで、他の追従を許さないオーディオ体験を提供します。すべての卑劣な足音とすべての爆発的な銃声は、正確な位置と驚くほどの明瞭さで再現され、リアルな戦場を作り出します。プラグアンドプレイ機能により、PS®4、PS®5、Switch™、PCなど、あらゆるプラットフォームで、余分な手間をかけずに、真に没入感のあるゲーム体験が可能になります。お好みの効果音をカスタマイズするには、弊社公式サイト(<https://www.eksa.net/download>)からドライバーをダウンロードするだけです。

注意: EKSA SoundBaseソフトウェアは、ウインドウズ®のみ対応しています。

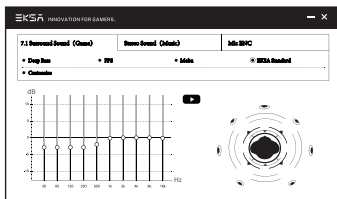
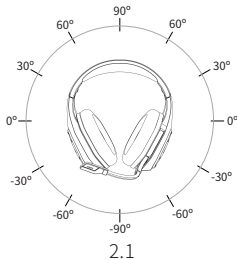



主な特徴

3. 広い互換性

3.5 mmオーディオケーブルとUSB Dongleを装備、PS®5、PS®4、Xbox® One、Nintendo Switch™、PC、Laptop、Mac、モバイル機器などに対応します。

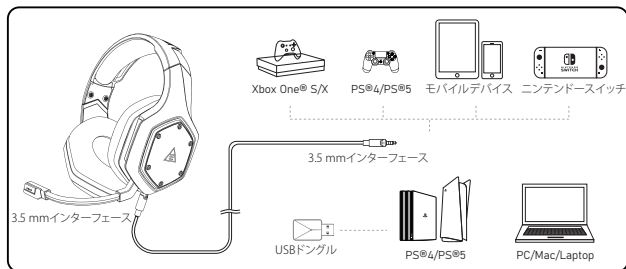

4. ワンキーサウンドモードスイッチ

このボタンはイヤージャェルにあり、7.1chサラウンドからゲームモード、ステレオからミュージックモードへの切り替えが可能です。

注意：サウンドモードを切り替えると、「surround sound on / off」という音声案内が流れます。

音声モード切替ボタン

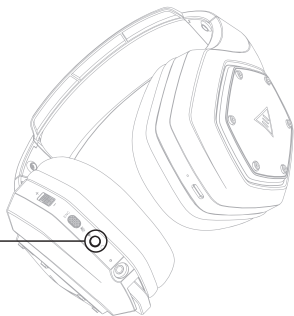



USB Dongle設定

以下の手順に従って、EKSA E1000 WT ヘッドセットがデフォルトのオーディオデバイスであることを確認します。操作が簡単で便利です。

Windows®:

オーディオ設定:



[コントロールパネル] ↓
[ハードウェアとサウンド] ↓
[サウンド] ↓
[再生] ↓
[EKSA E1000 WT (デフォルトデバイスとして設定)]



マイク設定:

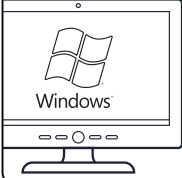

[コントロールパネル] ↓
[ハードウェアとサウンド] ↓
[サウンド] ↓
[録音] ↓
[EKSA E1000 WT (デフォルトデバイスとして設定)]



macOS:



[システム環境設定] ➡ [サウンド] ||| ➡
||| [入力] ➡ [EKSA E1000 WT]
||| [出力] ➡ [EKSA E1000 WT]





使用方法

プレイステーション®4 / プレイステーション®5:

PS®4/PS®5コントローラとUSB dongleまたは3.5 mmオーディオケーブルを接続する。その後、以下の手順で、PS®4/PS®5が自動的にオーディオ再生に切り替わり、マイクがオンになるようにオーディオ設定を確認してください。

PS®4

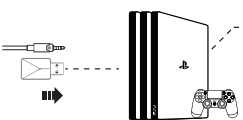

[設定]
↓
[デバイス]
↓
[オーディオデバイス]
↓
[出力デバイス - ヘッドセット (EKSA E1000 WT)]
↓
[入力デバイス - ヘッドセット (EKSA E1000 WT)]
↓
[音量調節 (ヘッドホン)]
↓
[マイクレベルを調整]
↓
 [出力デバイスを自動で切り替える]

PS®5

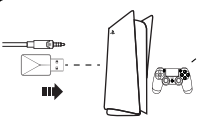

[設定]
↓
[サウンド]
↓
[マイク - 入力デバイス - ヘッドセット (EKSA E1000 WT)]
↓
[マイクレベルを調整]
↓
[オーディオ出力 - 出力デバイス - ヘッドセット (EKSA E1000 WT)]
↓
 [出力デバイスを自動で切り替える]
↓
[音量 - ヘッドホン]



使用方法

Xbox One® S/X:

NEWバージョンのXbox One® S/Xコントローラーで動作させるには、3.5mmオーディオケーブルでヘッドセットとコントローラーを直接接続することが可能です。

注意: 1. このヘッドセットはXbox®360には対応していません。

2. 旧バージョンのXbox® Oneはマイクロソフトのアダプター (別売) が必要です。

Xbox®ユーザー様向けガイド

コントローラに3.5 mmジャック:
アダプターは必要ありません



Xbox One® S/X コントローラー

コントローラには3.5 mm端子がありません:
マイクロソフトのアダプターが必要です
(別売)



Xbox® ワン コントローラ (旧バージョン)



よくあるご質問と回答

Q1: ヘッドセットから音が出ません。

- (1) まず、ヘッドホンがデバイスに正しく差し込まれていることを確認します。それでもうまくいかない場合は、オーディオ設定を確認して、スピーカーを有効にし、デバイスをミュートにしていないことを確認し、デバイスとヘッドホンの音量が適切なレベルであることを確認します。
- (2) USBトランスミッターまたは3.5 mmオーディオケーブルのプラグを抜いて差し直し、USBトランスミッターまたは3.5 mmインターフェースの汚れやほこりを拭き、ヘッドセットをデバイスに再接続し、マイクが機能するかどうかを確認します。
- (3) USB送信機が青く素早く点滅している場合、送信機をそのままにして、ヘッドセットの電源を切り、電源ボタンを6秒間押ししてください。ペアリングが成功したことを示す "ペアリング" の音声聞こえるまで指を離さないください。

Q2: ヘッドセットをコンピュータに接続した後、マイクが使えなくなりました。

- (1) コントロールパネル>サウンド>入力と進みます。ヘッドセットのマイクをデフォルトのマイクとして選択します。
- (2) ヘッドセットのマイクがミュートになっていないか確認してください。

Q3: 向こうの人に聞こえない。

- (1) ヘッドセットのマイクがミュートになっていないか確認してください。
- (2) 音声を確認し、ヘッドセットがデフォルトのデバイスであることを確認します。音声設定の具体的な内容は、P6、P7をご参照ください。
- (3) お使いの機器がヘッドセットに対応していることを確認してください。EKSA E1000 WTヘッドセットは、Xbox®360および旧バージョンのXbox®Oneには対応していませんので、別途マイクロソフトアダプター(別売)が必要です。
- (4) これらをすべて確認し、ヘッドセットがデバイスに適合しているにもかかわらず、マイクが動作しない場合は、弊社 (info@eksa.net) までご連絡ください。



Contenu de l'emballage

- ① Casque de jeu sans fil EKSA E1000 WT
- ② Câble audio 3,5 mm
- ③ Câble de chargement de type C
- ④ Dongle USB
- ⑤ Pochette de transport
- ⑥ Manuel de l'utilisateur

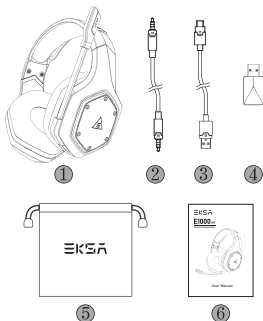

Spécifications



Taille : 50 mm
 Impédance unitaire (Ω) : 32 Ω
 Gamme de fréquences : 20 Hz - 20 kHz
 Sensibilité (dB/mW) : 105 \pm 3 dB



Type : Batterie au lithium
 Durée d'utilisation : Jusqu'à 36 heures (lumière éteinte)
 Puissance nominale : 5 V $\overline{\text{=}}$ 1 A
 Temps de charge : 2.5 H



Type : Microphone à condensateur
 Configuration polaire : Omnidirectionnel
 Sensibilité : -42 \pm 3 dB
 Impédance : 2.2 K Ω



Aperçu du produit

- ① Coussin de tête
- ② Réglage de la longueur
- ③ Lumières RVB colorées
- ④ Microphone rotatif
- ⑤ Coussins d'oreille
- ⑥ Dongle USB 2.4G
- ⑦ Câble audio de 3,5 mm à 3,5 mm
- ⑧ Réglage du volume
- ⑨ Bouton de coupure du micro / bouton ENC
- ⑩ Bouton Marche / Arrêt / Bouton multifonctionnel
- ⑪ Indicateur d'état
- ⑫ Interface mode filaire 3,5 mm
- ⑬ Indicateur de charge
- ⑭ Port de charge de type C

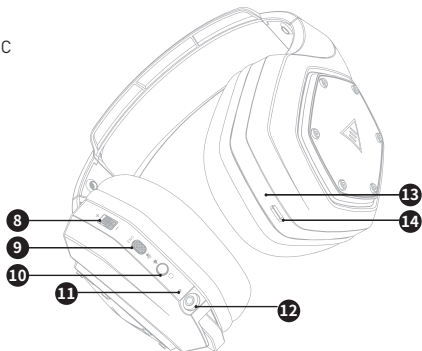
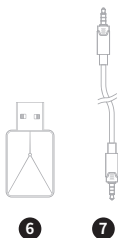
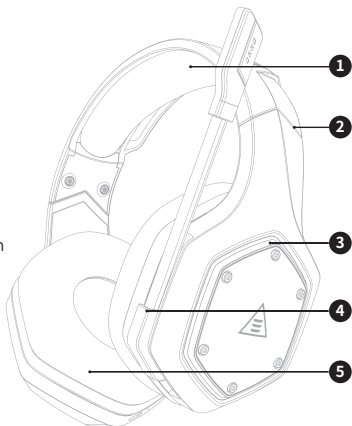



Guide d'utilisation



Molette de contrôle du volume :



Faire défiler vers le haut : Volume +



Défilement vers le bas : Volume -



Bouton micro :

ENC



Appuyez pendant 3 secondes :
ENC on / off



Cliquer : Microphone on / off



Bouton d'alimentation :



Appuyez pendant 3 secondes :
Mise sous tension / hors tension



Clic : Son surround activé / désactivé



Double-clic : Lumière allumée / éteinte

Mode filaire :

Lorsque le câble audio de 3,5 mm est branché, l'oreillette s'éteint automatiquement. Seul le contrôle du volume fonctionne alors que tous les autres boutons ne fonctionnent pas.



Caractéristiques principales

1. EKSA VoicePure ENC

Perfectionnez votre communication de jeu avec EKSA VoicePure ENC. Il isole votre voix du bruit environnant grâce à un microphone antibruit, éliminant jusqu'à 96 % des bruits de fond gênants. Votre voix sera naturelle et claire dans les discussions du jeu, ce qui vous donnera un avantage compétitif supplémentaire.

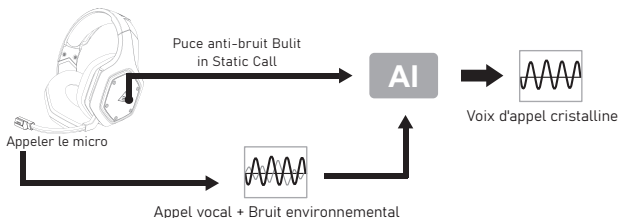

2. EKSA 7.1 SoundBase

EKSA 7.1 SoundBase offre une expérience audio inégalée avec un son percutant et immersif. Chaque pas furtif et chaque coup de feu explosif est reproduit avec un positionnement précis et une clarté étonnante, créant un champ de bataille réaliste. Grâce à la fonction brancher-et-jouer, vous n'aurez pas de tracas supplémentaires pour bénéficier d'une expérience de jeu réellement immersive sur toutes les plateformes - notamment PS®4, PS®5, Switch™ et PC. Pour personnaliser vos effets sonores préférés, il suffit de télécharger le pilote sur notre site officiel (<https://www.eksa.net/download>).
Remarque : le logiciel EKSA SoundBase est compatible avec Windows® uniquement.

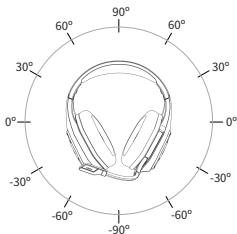

2.1

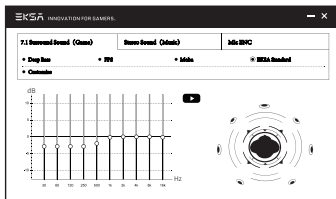

2.2



Caractéristiques principales

3. Compatibilité étendue

Équipé d'un câble audio de 3,5 mm et d'un dongle USB, compatible avec PS®5, PS®4, Xbox® One, Nintendo Switch™, PC, ordinateur portable, Mac, appareils mobiles, etc.

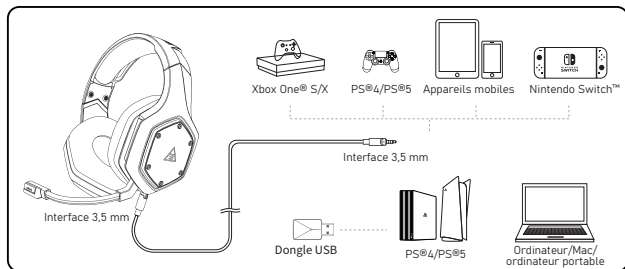

4. Commutateur de mode sonore à une touche

Ce bouton se trouve sur la coque de l'oreille, vous permettant de passer du son surround 7.1 au mode jeu ou de la stéréo au mode musique. Il est simple et pratique à utiliser.

Remarque : lorsque vous changez de mode sonore, vous entendrez un message vocal indiquant que le son surround sound on / off.

Bouton de commutation de mode sonore

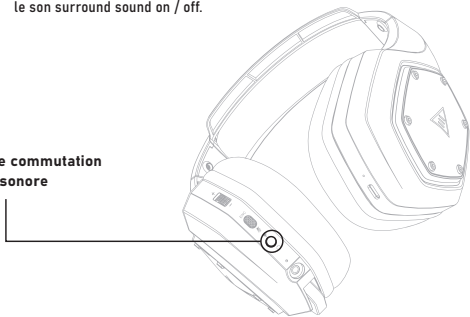



Paramètres du dongle USB

Suivez les étapes ci-dessous pour vous assurer que votre casque EKSA E1000 WT est le périphérique audio par défaut.

Windows®:

Les paramètres audio:



[Panneau de configuration] ↓
[Matériel et son] ↓
[Son] ↓
[Lecture] ↓
[EKSA E1000 WT
(Définir comme dispositif par défaut)]



Paramètres du microphone :





[Panneau de configuration] ↓
[Matériel et son] ↓
[Son] ↓
[Enregistrement] ↓
[EKSA E1000 WT
(Définir comme dispositif par défaut)]



macOS:



[Préférences système] → [Son] 
 [Entrée] → [EKSA E1000 WT]
[Sortie] → [EKSA E1000 WT]





Comment utiliser

PlayStation® 4 / PlayStation® 5:

Connectez le dongle USB ou le câble audio 3,5 mm à votre manette PS®4/PS®5. Ensuite, suivez les étapes ci-dessous pour vérifier les paramètres audio afin de vous assurer que votre PS®4/PS®5 passe automatiquement en lecture audio et active le microphone.

PS®4

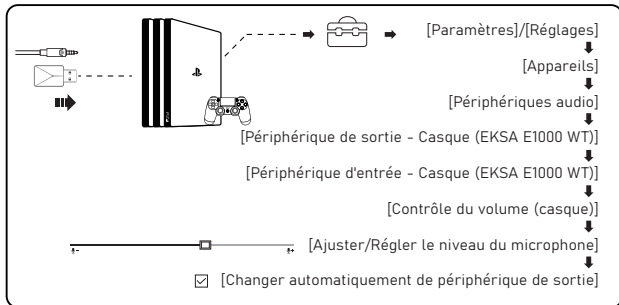

PS®5

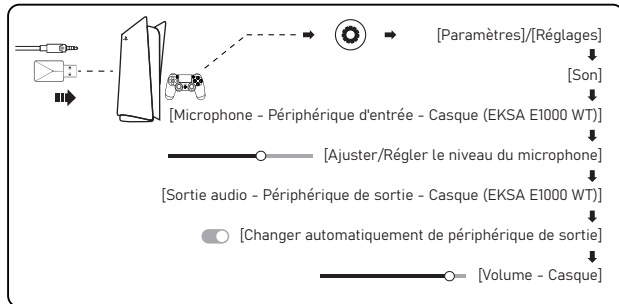



Comment utiliser

Xbox One® S/X:

Pour travailler sur la NOUVELLE version de la manette Xbox One® S/X, vous pouvez connecter directement votre casque à la manette via le câble audio 3,5 mm.

Notes : 1. Le casque n'est pas compatible avec la Xbox®360.

2. L'ancienne version de la Xbox® One nécessite un adaptateur Microsoft (non inclus).

Guide pour les utilisateurs Xbox®

La manette dispose d'une prise jack 3,5 mm : aucun adaptateur n'est nécessaire



Manette Xbox One® S/X

La manette n'a pas de prise jack 3,5 mm : un adaptateur Microsoft est requis (non inclus)



Manette Xbox® One (ancienne version)



FAQ

Q1 : Mon casque n'a pas de son.

- (1) Tout d'abord, assurez-vous que vous avez branché le casque correctement sur votre appareil. Si cela ne fonctionne pas, vérifiez vos paramètres audio pour vous assurer que vous activez vos haut-parleurs et que vous ne coupez pas le son de votre appareil, puis vérifiez le volume de votre appareil et de votre casque pour vous assurer qu'il est à un niveau correct.
- (2) Débranchez le transmetteur USB ou le câble audio de 3,5 mm et rebranchez-le ; essuyez la saleté ou la poussière sur le transmetteur USB ou l'interface de 3,5 mm ; rebranchez le casque à l'appareil et vérifiez si le microphone fonctionne.
- (3) Si la lumière bleue de l'émetteur USB clignote rapidement, laissez l'émetteur là où il est, et éteignez votre oreillette, puis appuyez sur le bouton d'alimentation pendant 6 secondes. Ne relâchez pas votre doigt avant d'entendre un avis vocal de jumelage", ce qui signifie que le jumelage est maintenant réussi."

Q2 : Après avoir connecté l'oreillette à mon ordinateur, je ne peux pas utiliser son microphone.

- (1) Allez dans le panneau de configuration Son>Entrée. Choisissez le microphone du casque comme micro par défaut.
- (2) Vérifiez que le microphone du casque n'est pas coupé.

Q3 : Les personnes à l'autre bout du fil ne m'entendent pas.

- (1) Vérifiez que le microphone du casque n'est pas muet.
- (2) Vérifiez l'audio et assurez-vous que votre casque est le périphérique par défaut. Veuillez vous reporter aux pages 6 et 7 pour des informations plus spécifiques sur les réglages du son.
- (3) Assurez-vous que votre appareil est compatible avec l'oreillette. Le casque EKSA E1000 WT n'est pas compatible avec la Xbox®360 et l'ancienne version de la Xbox®One nécessite un adaptateur microsoft supplémentaire (non inclus).
- (4) Si tout cela a été vérifié et que le casque est compatible avec l'appareil mais que le microphone ne fonctionne toujours pas, veuillez nous contacter (info@eksa.net).



Paketinhalt

- ① EKSA E1000 WT Wireless Gaming Headset
- ② 3,5mm Audiokabel
- ③ Typ C Ladekabel
- ④ USB-Dongle
- ⑤ Tragebeutel
- ⑥ Benutzerhandbuch

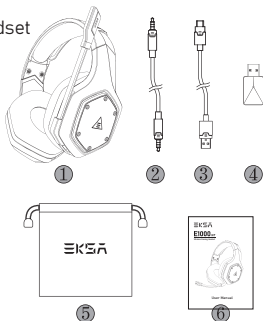

Spezifikationen



Größe: 50mm
 Impedanz Einheit (Ω): 32 Ω
 Frequenzbereich: 20Hz - 20 kHz
 Empfindlichkeit (dB/mW) : 105 \pm 3 dB



Typ: Lithium-Batterie
 Nutzungsdauer: Bis zu 36 Stunden (Licht aus)
 Nennleistung: 5 V $\overline{=}$ 1 A
 Ladezeit: 2.5 H



Typ: Kondensator-Mic
 Polarmuster: Omnidirektionale
 Empfindlichkeit: -42 \pm 3 dB
 Impedanz: 2.2 K Ω



Produktübersicht

- ① Kopfkissen
- ② Längenanpassung
- ③ Bunte RGB-Leuchten
- ④ Drehbares Mikrofon
- ⑤ Ohrpolster
- ⑥ USB 2.4G Dongle
- ⑦ 3,5 mm bis 3,5 mm Audiokabel
- ⑧ Lautstärkereglер
- ⑨ Mic Stumm schalten Taste/
ENC-Taste
- ⑩ Ein-/Ausshalter/
Multifunktionstaste
- ⑪ Statusanzeige
- ⑫ 3,5 mm kabelgebundene Modus-Schnittstelle
- ⑬ Ladeanzeige
- ⑭ Typ-C-Ladeanschluss

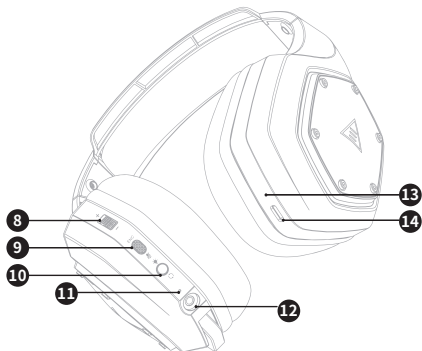
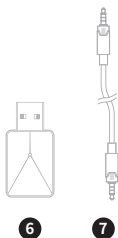
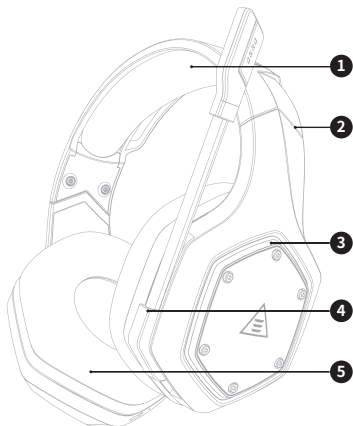



Bedienungsanleitung



Lautstärkereglerrad:



Scrollen Sie nach oben: Lautstärke +



Scrollen Sie nach unten: Lautstärke-



Mic-Knopf:

ENC



Drücken Sie für 3 Sekunden:
ENC ein/aus



Klicken Sie auf: Mikrofon ein/aus



Power-Taste:



Drücken Sie für 3 Sekunden:
ein-/ausschalten



Klicken Sie auf:
Surround Sound ein/aus



Doppelklicken: Licht ein/aus

drahtgebundener Modus:

Wenn das 3,5-mm-Audiokabel eingesteckt wird, schaltet sich der Kopfhörer automatisch aus. Nur der Lautstärkeregler funktioniert, während alle anderen Tasten dies nicht tun.



Hauptmerkmale

1. EKSA VoicePure ENC

Vervollkommen Sie Ihre Spielkommunikation mit EKSA VoicePure ENC. Es isoliert Ihre Stimme von den Geräuschen um Sie herum mit einem geräuschunterdrückenden Mikrophon und eliminiert bis zu 96% der ablenkenden Hintergrundgeräusche. Sie werden natürliche und klare Chats im Spiel klingen und Ihnen einen zusätzlichen Wettbewerbsvorteil verschaffen.

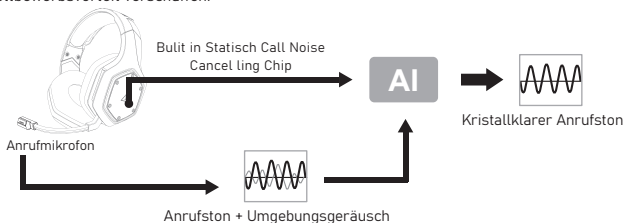

2. EKSA 7.1 SoundBase

EKSA 7.1 Sound Base bietet ein unvergleichliches Audioerlebnis mit druckvollem und immersivem Klang. Jeder hinterhältige Schritt und jeder explosive Schuss wird mit genauer Positionierung und atemberaubender Klarheit reproduziert, wodurch ein lebensechtes Schlachtfeld entsteht. Die Plug-and-Play-Funktion bedeutet keinen zusätzlichen Aufwand, um ein wirklich beeindruckendes Spielerlebnis auf allen Plattformen zu erzielen - einschließlich PS®4, PS®5, Switch™ und PC. Um Ihre bevorzugten Soundeffekte anzupassen, laden Sie einfach den Treiber von unserer offiziellen Website (<https://www.eksa.net/download>) herunter.

Anmerkung: EKSA Sound Base Software unterstützt Windows®Nur.

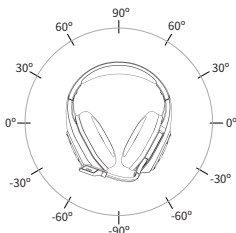

2.1

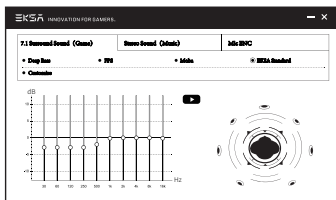

2.2



Hauptmerkmale

3. Breite Verträglichkeit

Ausgestattet mit 3,5mm Audiokabel und USB-Dongle, Kompatibel mit PS®5, PS®4, Xbox® One, Nintendo Schalter™, PC, Laptop, Mac, mobile Geräte usw.

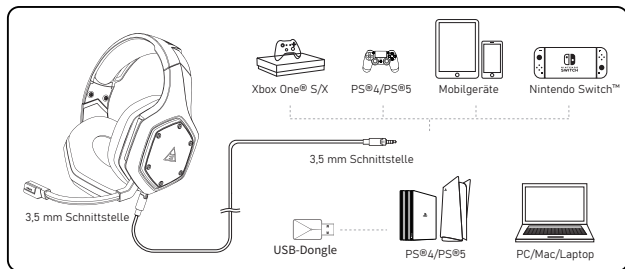

4. Ein Schlüssel Sound-Modus-Schalter

Diese Taste befindet sich an der Ohrmuschel, sodass Sie von 7.1-Surround-Sound in den Spielmodus oder von Stereo in den Musikmodus wechseln können. Es ist unkompliziert und bequem zu bedienen.

Hinweis: Wenn Sie den Sound modus wechseln, hören Sie eine Sprachaufforderung "surround sound on / off".

Klangmodus-Knopfschalter

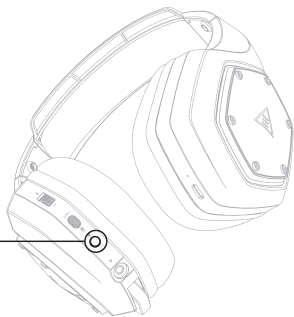



USB-Dongle-Einstellungen

Befolgen Sie die folgenden Schritte, um sicherzustellen, dass Ihr EKSA E1000 WT Kopfhörer das Standard-Audiogerät ist.

Windows®:

Audio-Einstellungen:



[Schalttafel] ↓
[Hardware und Ton] ↓
[Klang] ↓
[Wiedergabe] ↓
[EKSA E1000 WT
(Als Standardgerät festlegen)]



Mikrofoneinstellungen:





[Schalttafel] ↓
[Hardware und Ton] ↓
[Klang] ↓
[Aufzeichnung] ↓
[EKSA E1000 WT
(Als Standardgerät festlegen)]



macOS:



[Systemeinstellungen] → [Klang] 
 [Eingang] → [EKSA E1000 WT]
[Ausgabe] → [EKSA E1000 WT]





Wie wird es benutzt

PlayStation® 4 / PlayStation® 5:

Verbinden Sie den USB Dongle oder das 3,5-mm-Audiokabel mit Ihrem PS®4/PS®5 Steuergerät. Folgen Sie dann den folgenden Schritten zur Überprüfung der Audioeinstellungen, um sicherzustellen, dass Ihr PS®4/PS®5 automatisch Audio spielt und Mikrofon einschaltet.

PS®4

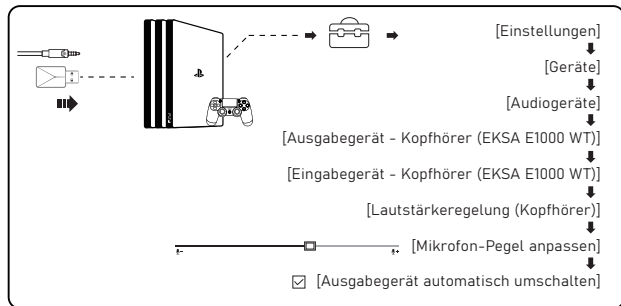

PS®5

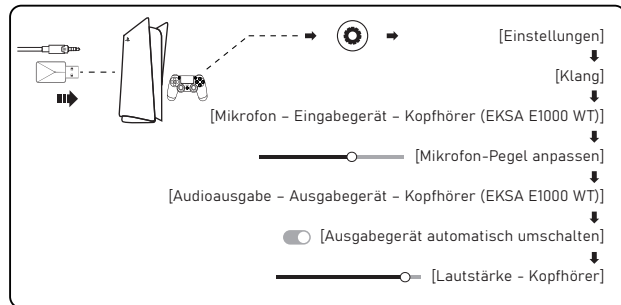



Wie wird es benutzt

Xbox One® S/X:

Um an der NEUEN Version der Xbox One zu arbeiten®S/X-Steuergerät können Sie Ihren Kopfhörer über das 3,5-mm-Audiokabel direkt mit dem Steuergerät verbinden.

Anmerkungen: 1. Der Kopfhörer ist nicht mit Xbox kompatibel®360.

2. Alte Version von Xbox®Man braucht einen Microsoft-Adapter (nicht im Lieferumfang enthalten).

Hinweis für Xbox One® S/X-Benutzer

Der Controller hat eine 3,5 mm Buchse:
kein Adapter erforderlich



Xbox One® S/X-Controller

Der Controller hat keine 3,5 mm Buchse:
Microsoft-Adapter erforderlich
(Nicht im Lieferumfang enthalten)



Xbox® One-Controller (alte Version)



FAQ

Q1: Mein Kopfhörer hat keinen Ton.

- (1) Stellen Sie zunächst sicher, dass Sie den Kopfhörer korrekt an Ihr Gerät angeschlossen haben. Wenn dies nicht funktioniert, überprüfen Sie Ihre Audioeinstellungen, um sicherzustellen, dass Ihr Lautsprecher aktiviert und Ihr Gerät nicht stumm geschaltet wird. Überprüfen Sie dann die Lautstärke Ihres Geräts und Ihres Kopfhörers, um sicherzustellen, dass es auf einem angemessenen Niveau ist.
- (2) Ziehen Sie den USB-Transmitter oder das 3,5-mm-Audiokabel aus und stecken Sie es wieder ein. Wischen Sie den Schmutz oder Staub auf dem USB-Transmitter oder der 3,5-mm-Schnittstelle ab. Anschließend schließen Sie den Kopfhörer wieder an das Gerät an und prüfen Sie, ob das Mikrofon funktioniert.
- (3) Wenn das blaue Licht von USB-Transmitter schnell blinkt, halten Sie den Transmitter fest und schalten Sie Ihren Kopfhörer aus, dann drücken Sie die Power-Taste für 6 Sekunden. Lassen Sie Ihren Finger erst los, wenn Sie eine Sprachmeldung von „Paarung“ hören, was bedeutet, dass die Paarung jetzt erfolgreich ist.

Q2: Nachdem der Kopfhörer mit meinem Computer verbunden ist, kann ich das Mikrofon nicht verwenden.

- (1) Gehen Sie zur Systemsteuerung>Klang>Eingabe Wählen Sie das Mikrofon des Kopfhörers als Standardmikrofon.
- (2) Überprüfen Sie, ob das Mikrofon des Kopfhörers stummgeschaltet ist.

Q3: Die Menschen auf der anderen Seite können mich nicht hören.

- (1) Überprüfen Sie, ob das Mikrofon des Kopfhörers stummgeschaltet ist.
- (2) Überprüfen Sie das Audio und stellen Sie sicher, dass Ihr Kopfhörer das Standardgerät ist. Weitere Informationen zu Klang finden Sie auf Seite 6 und 7 Einstellungen.
- (3) Stellen Sie sicher, dass Ihr Gerät mit dem Kopfhörer kompatibel ist. EKSA E1000 WT Headset ist nicht kompatibel mit Xbox®360 und die alte Version von Xbox®Man benötigt einen zusätzlichen Microsoft-Adapter (nicht im Lieferumfang enthalten).
- (4) Wenn alle diese überprüft wurden und der Kopfhörer mit dem Gerät kompatibel ist, während das Mikrofon noch nicht funktioniert, kontaktieren Sie uns bitte (info@eksa.net).



Содержимое упаковки

- ① Беспроводные игровые наушники EKSA E1000 WT
- ② Аудио-кабель 3,5 мм
- ③ Зарядный кабель тип-C
- ④ USB-адаптер
- ⑤ Сумка для перевозки
- ⑥ Руководство для пользователя

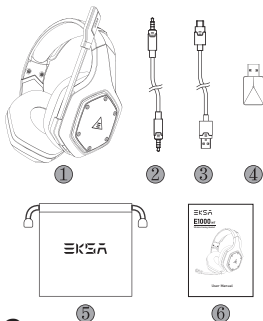

Технические характеристики



Размер: 50мм
 Удельный импеданс (Ом): 32 Ом
 Диапазон частот: 20 Гц - 20 кГц
 Чувствительность (дБ/мВт): 105± 3 дБ



Тип: Литиевая аккумуляторная батарейка
 Продолжительность работы:
 До 36 часов (при выключении лампы)
 Номинальная мощность: 5 В \approx 1 А
 Продолжительность зарядки: 2,5 Н



Тип: Конденсаторный микрофон
 Полярная диаграмма: всенаправленная
 Чувствительность: -42 ± 3 дБ
 Импеданс: 2,2 кОм



Краткие сведения о продукции

- ① Оголовье
- ② Регулирование длины
- ③ Цветное освещение RGB
- ④ Вращающийся микрофон
- ⑤ Амбушюры
- ⑥ USB-адаптер 2,4G
- ⑦ Аудио-кабель 3,5 мм к 3,5 мм
- ⑧ Регулятор громкости
- ⑨ Кнопка отключения микрофона / кнопка ENC
- ⑩ Кнопка включения / выключения / Многофункциональная кнопка
- ⑪ Индикатор состояния
- ⑫ Интерфейс проводного режима 3,5 мм
- ⑬ Индикатор зарядки
- ⑭ Порт типа-C для зарядки

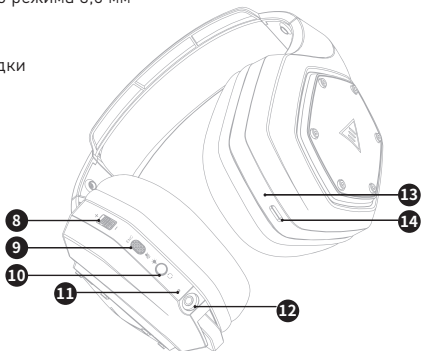
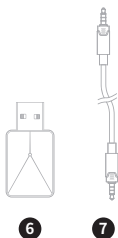
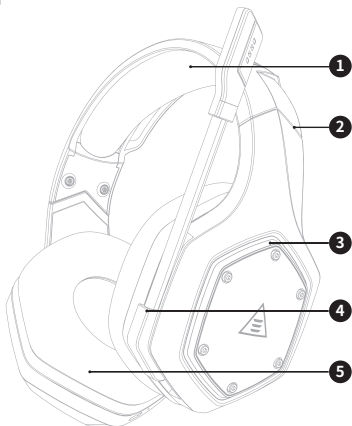



Руководство по эксплуатации



Регулятор громкости:



Покрутите вверх: Громкость +



Покрутите вниз: Громкость -



Кнопка микрофона:

ENC



Нажмите на 3 сек.: ENC вкл. / выкл.



Щелчок: Микрофон вкл./выкл.



Кнопка питания:



Нажмите на 3 сек.:
Питание вкл. / выкл.



Щелчок: Объемный звук вкл. / выкл.



Двойной щелчок:
Подсветка вкл./выкл.

Проводной режим:

При вставке аудио-кабеля 3,5 мм наушники будут переключены автоматически. Только регулятор громкости работает, когда все остальные кнопки недействительны.



Основные характеристики

1. KSA VoicePure ENC

Улучшается ваше общение в играх с помощью EKSA VoicePure ENC. Оно изолирует ваш голос от шума окружающей среды с помощью микрофона с шумоподавлением, устраняя до 96% отвлекающих шумов от окружающей среды. Вы будете озвучиваться реальным и четким голосом в игровых чатах, что дает вам дополнительное конкурентное преимущество.

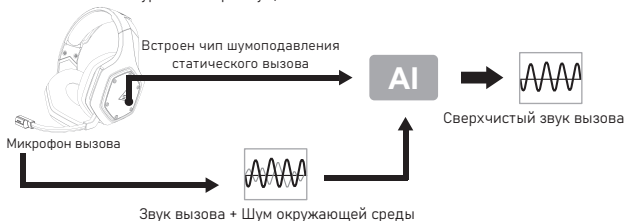

2. EKSA 7.1 SoundBase

EKSA 7.1 SoundBase предоставляет уникальное акустическое наслаждение энергичным звуком. Каждый крадущийся шаг и каждый разрывной выстрел воспроизведены с точным позиционированием и уникальной четкостью, что создает реалистичное поле боя. Характеристика «подключи и работай» означает, что нет дополнительного барьера для получения реального игрового опыта с эффектом присутствия через платформы – в том числе PS®4, PS®5, Switch™ и ПК. В целях настройки предпочтенных эффектов звука, просто скачать драйвер с нашего официального сайта (<https://www.eksa.net/download>).

Примечание: Программное обеспечение EKSA SoundBase поддерживает только Windows®.

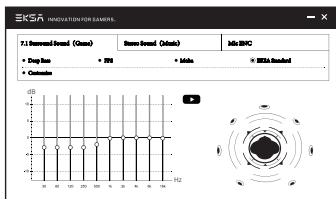
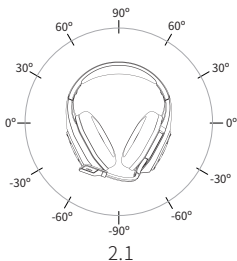



Основные характеристики

3. Широкая совместимость

Оснащается аудио-кабелем 3,5 мм и USB-адаптером, применяется для PS®5, PS®4, Xbox® One, Nintendo Switch™, ПК, Ноутбук, Mac, мобильных устройств и др.

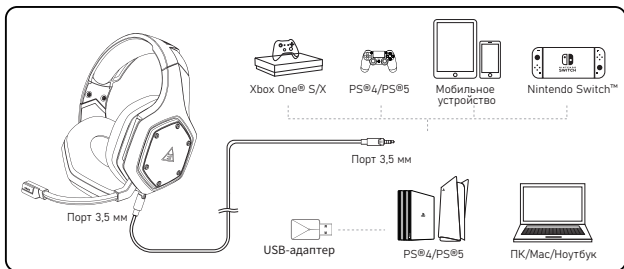

4. Переключение режима звука с одной кнопки

Данная кнопка расположена на ушной оболочке, позволяет вам переключать с звука окружающей среды на игровой режим или музыкальный режим стерео. Простота и удобство для эксплуатации.

Примечание: при переключении режима звука, вы будете слышать голосовую подсказку «surround sound on / off».

Кнопка для переключения режима звука

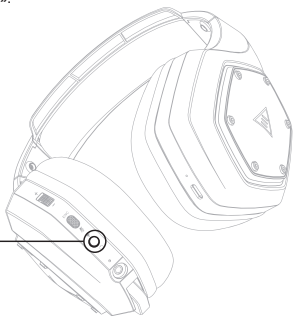



Настройки USB-адаптера

Соблюдайте следующие шаги для обеспечения того, что наушники EKSA E1000 WT являются аудио-устройством по умолчанию.

Windows®:

Настройки звука:



[Панель управления] ↓
[Аппаратное обеспечение и звук] ↓
[Звук] ↓
[Воспроизведение] ↓
[EKSA E1000 WT
(Настроить как устройство по умолчанию)]



Настройки микрофона:



[Панель управления] ↓
[Аппаратное обеспечение и звук] ↓
[Звук] ↓
[Запись] ↓
[EKSA E1000 WT
(Настроить как устройство по умолчанию)]



macOS:



[Системные настройки] → [Звук] →

→ [Вход] → [EKSA E1000 WT]
→ [Выход] → [EKSA E1000 WT]





Как использовать

PlayStation® 4 / PlayStation® 5:

Соедините USB-адаптер или аудио-кабель 3,5 мм с вашим геймпадом PS®4/PS®5. Тогда соблюдайте следующие шаги для проверки акустических настроек, чтобы убедиться в том, что ваш PS®4/PS®5 автоматически переключено на воспроизведение звука.

PS®4

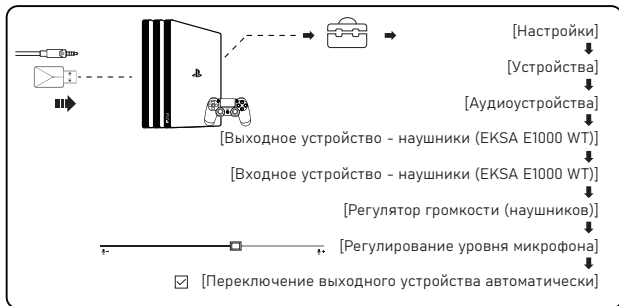

PS®5

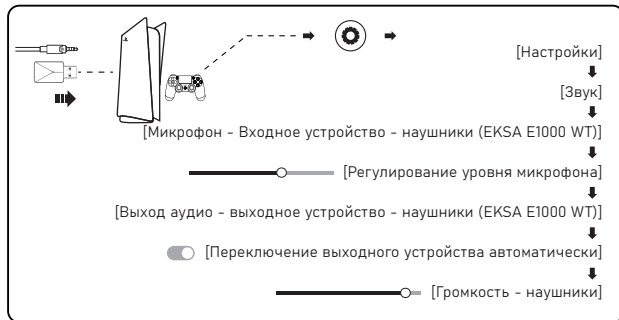



Как использовать

Хbox One® S/X:

В целях работы над Новой версией геймпада от Xbox One® S/X, вы можете непосредственно соединить наушники с геймпадом с помощью аудио кабеля 3,5 мм.

Примечания: 1. Наушники не совместимы с Xbox®360.

2. Старая версия Xbox® One требует адаптер Microsoft (не поставлен в комплекте).

Руководство для пользователей Xbox®

При наличии разъема 3,5 мм на контроллере: не нужен адаптер



Геймпад Xbox One® S/X

При отсутствии разъема 3,5 мм на контроллере: нужен адаптер Microsoft (не поставлен в комплекте)



Геймпад Xbox® One (старой версии)



Вопрос и ответ

Вопрос 1: В моих наушниках нет звука.

- (1) Во-первых, убедитесь в том, что вы подключили наушники к вашему устройству. Если это не справиться, проверьте ваши настройки, убедитесь в том, что ваши микрофоны были включены, и не отключать ваше устройство, проверьте громкость вашего устройства и наушников, и убедитесь в том, что громкость была на подходящем уровне.
- (2) Отсоедините USB-трансмисмиттер или аудио-кабель 3,5 мм и вставьте их еще раз; удалите грязи или пыли от USB-трансмисмиттера или интерфейса 3,5 мм; еще раз соедините наушники с устройством, проверьте на правильность работы микрофона.
- (3) Если USB-трансмисмиттер мерцает голубым светом быстро, сохраните трансмиттер в том месте, где он находится, выключите наушники, тогда нажмите кнопку включения на 6 секунд. Не освободите ваш палец, пока был не слышен звук напоминания «спаривается», что означает успешное выполнение спаривания.

Вопрос 2: Как я соединил наушники с моим компьютером, я не могу использовать их микрофон.

- (1) Перейти в панель управления>Звук>Ввод. Выберите микрофон наушников как микрофон по умолчанию.
- (2) Проверьте микрофон наушников на то, что выключен ли он.

Вопрос 3: Тот, кто находится на другой стороне, меня не слышит.

- (1) Проверьте микрофон наушников на то, что выключен ли он.
- (2) Проверьте звук, убедитесь в том, что ваши наушники являются устройством по умолчанию. Ссылайтесь на стр. 6 или 7 за больше специальной информацией для настроек звука.
- (3) Убедитесь в том, что ваше устройство применяется для наушников. Наушники EKSA E1000 WT не применяются для Xbox®360, для старой версии Xbox®One нужен дополнительный адаптер Microsoft (не поставлен в комплекте).
- (4) Если все проверки выполнены, и наушники совместимы с устройством, однако микрофон все еще не работает, обращайтесь к нам (info@eksa.net).



Contenido del Empaque

- ① Auriculares Inalámbricos para Juego EKSA E1000 WT
- ② Cable de Audio de 3.5 mm
- ③ Cable de Carga Tipo C
- ④ Conector USB
- ⑤ Bolsa de Transporte
- ⑥ Manual de Usuario

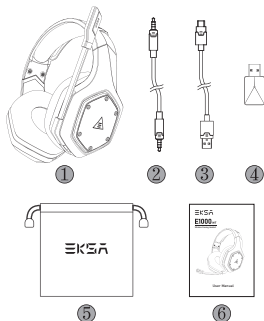

Especificaciones



Tamaño: 50 mm
 Impedancia Unitaria (Ω): 32 Ω
 Rango de Frecuencia: 20 Hz - 20 kHz
 Sensibilidad (dB/mW) : 105 \pm 3 dB



Tipo: Batería de Lito
 Tiempo de Uso: Hasta 36 horas (con luz apagada)
 Potencia Nominal: 5 V $\overline{=}$ 1 A
 Tiempo de Carga: 2.5 H



Tipo: Micrófono de Condensador
 Patrón de Polaridad: Omnidireccional
 Sensibilidad -42 \pm 3 dB
 Impedancia 2.2 K Ω



Descripción del Producto

- ① Cojín para la cabeza
- ② Longitud ajustable
- ③ Luces de Colores RGB
- ④ Micrófono Rotatorio
- ⑤ Cojines para las orejas
- ⑥ Conector USB 2.4G
- ⑦ Cable de Audio de 3.5 mm a 3.5 mm
- ⑧ Ajustador de Volumen
- ⑨ Botón para Silenciar Micrófono / Botón ENC
- ⑩ Botón de Encendido / Apagado / Botón Multifuncional
- ⑪ Indicador de Estado
- ⑫ Interfaz de Modo Alámbrico de 3.5 mm
- ⑬ Indicador de Carga
- ⑭ Puerto de Carga Tipo-C

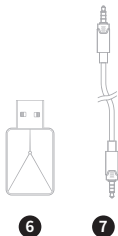
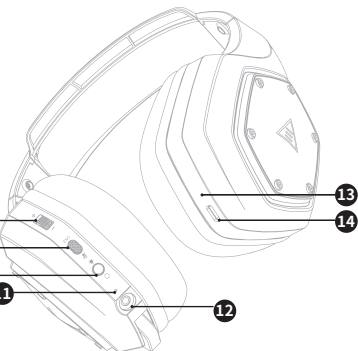
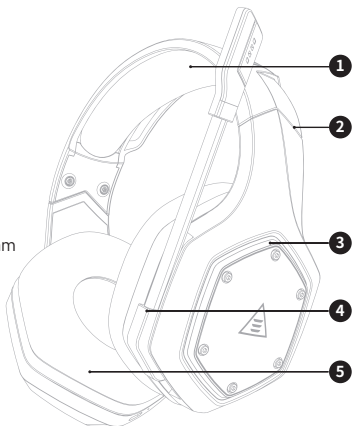



Guía de Operación



Rueda para Control de Volumen:



Desplazando hacia arriba: Volumen +



Desplazando hacia abajo: Volumen -



Botón de Micrófono:

ENC



Presiona por 3 segundos:
ENC Encendido / Apagado



Click: Micrófono Encendido / Apagado



Botón de Encendido:



Presiona por 3 segundos:
Encendido / Apagado



Click:
Sonido Envoltivo Encendido / Apagado



Doble-click: Luz Encendida / Apagada

Modo Alámbrico:

Cuando el cable de audio de 3.5 mm se conecte, los auriculares se apagarán automáticamente. Sólo el control de volumen funciona mientras que el resto de los botones no.



Características Principales

1. EKSA VoicePure ENC

Perfecciona la comunicación al jugar con EKSA VoicePure ENC. Aísla tu voz del ruido a tu alrededor con un micrófono de cancelación de ruido, eliminando hasta el 96 % del distractor ruido de fondo. Sonarás natural y claro en los chats de juego, lo que te dará una ventaja competitiva adicional.



2. EKSA 7.1 SoundBase

EKSA 7.1 SoundBase proporciona una experiencia de audio inigualable con un sonido impactante e inmersivo. Cada pisada furtiva y cada disparo explosivo son reproducidos con precisión del posicionamiento y una claridad asombrosa, creando un campo de batalla realista. Con la función plug-and-play no habrá problemas adicionales para tener una experiencia de juego verdaderamente inmersiva en todas las plataformas -incluidas PS®4, PS®5, Switch™ y PC. Para personalizar tus efectos de sonido preferidos, simplemente descarga el driver de nuestro sitio web oficial (<https://www.eksa.net/download>).

Nota: El Software EKSA SoundBase sólo es compatible con Windows®.

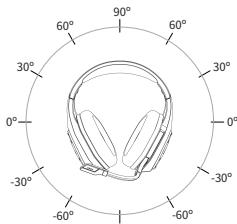

2.1

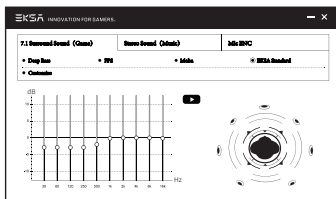

2.2



Características Principales

3. Amplia Compatibilidad

Equipado con un cable de audio de 3.5 mm y un conector USB, compatible con PS®5, PS®4, Xbox® One, Nintendo Switch™, PC, Laptop, Mac, dispositivos móviles, etc.

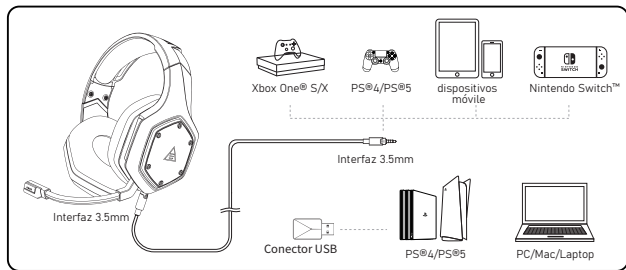

4. Interruptor de Modo de Sonido de Una Tecla

Este botón se encuentra en el auricular y te permite cambiar del sonido envolvente 7.1 hacia el modo de juego o estéreo, o al modo de música. Es sencillo y cómodo de operar.

Nota: al cambiar al modo de sonido, escucharás el mensaje de voz "surround sound on / off".

Botón para Cambiar el
Modo de Sonido

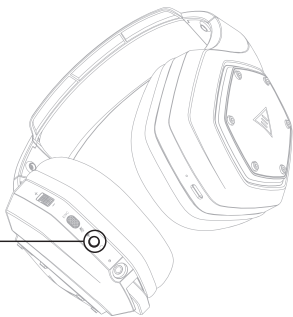



Configuración del Conector USB

Sigue los pasos a continuación para asegurarte de que tus auriculares EKSA E1000 WT son el dispositivo de audio por defecto.

Windows®:

Configuración de Audio:



[Panel de Control] ↓
[Hardware y Sonido] ↓
[Sonido] ↓
[Reproducción] ↓
[EKSA E1000 WT
(Configurar como Dispositivo Predeterminado)]



Configuración del micrófono:





[Panel de Control] ↓
[Hardware y Sonido] ↓
[Sonido] ↓
[Grabación] ↓
[EKSA E1000 WT
(Configurar como Dispositivo Predeterminado)]



macOS:



[Preferencias de Sistema] → [Sonido] 
 [Entrada] → [EKSA E1000 WT]
[Salida] → [EKSA E1000 WT]





Cómo Usar

PlayStation® 4 / PlayStation® 5:

Conecta la interfaz USB o el cable de audio de 3.5mm a tu controlador de PS®4/PS®5. Luego sigue los pasos a continuación para verificar las configuraciones de audio y asegurarte de que tu PS®4/PS®5 cambia automáticamente para reproducir audio y enciende el micrófono.

PS®4

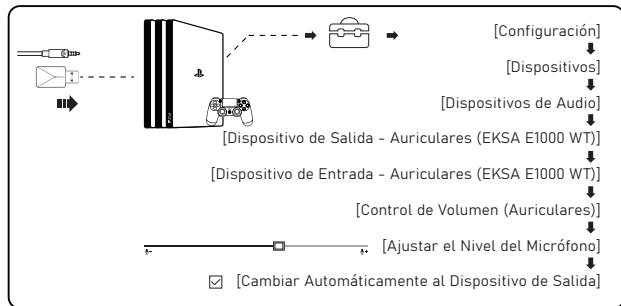

PS®5

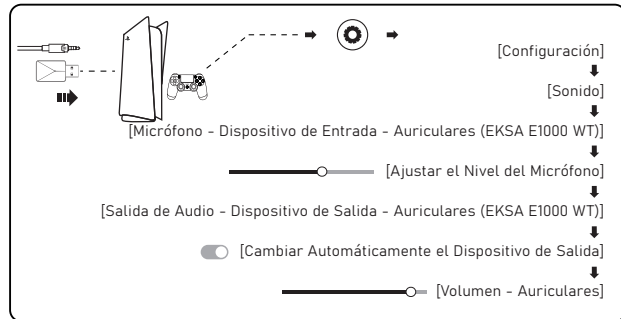



Cómo Usar

Xbox One® S/X:

Para trabajar en la NUEVA versión del controlador Xbox One® S/X, puedes conectar directamente tus auriculares al controlador a través del cable de audio de 3.5 mm.

Notas: 1. Los auriculares no son compatibles con Xbox®360.

2. Versiones anteriores de Xbox® One requieren un adaptador Microsoft (no incluido).

Guía para Usuarios de Xbox®

El controlador tiene un jack de 3,5 mm:
ningún adaptador es requerido



Controlador de Xbox One® S/X

El controlador no tiene un jack de 3,5 mm:
un adaptador Microsoft es requerido
(no incluido)



Controlador (versión anterior)
de Xbox® One



FAQ

P1: Mis auriculares no tienen sonido.

- (1) Primero, asegúrate de haber conectado correctamente los auriculares a tu dispositivo. Si eso no funciona, revisa la configuración de audio para asegurarte que los altavoces están habilitados y que tu dispositivo no está silenciado, luego verifica el volumen de tu dispositivo y auriculares para asegurarte de que esté en un nivel adecuado.
- (2) Desconecta el transmisor USB o el cable de audio de 3.5 mm y vuelve a enchufarlo; limpia la suciedad o el polvo en el transmisor USB o la interfaz de 3.5 mm; vuelve a conectar los auriculares al dispositivo y verifica si el micrófono funciona.
- (3) Si el transmisor USB parpadea rápidamente con una luz azul, mantenlo donde está y apaga los auriculares, luego presiona el botón de encendido durante 6 segundos. Mantén presionado hasta que escuches el aviso de voz "pairing", lo que significa que el emparejamiento ha sido exitoso.

P2: Después de que he conectado mis auriculares a mi computadora, no puedo usar su micrófono.

- (1) Ve a Panel de control>Sonido>Entrada. Elige el micrófono de los auriculares como micrófono por defecto.
- (2) Verifica que el micrófono de los auriculares no se encuentre silenciado.

P3: Las personas al otro lado no pueden escucharme.

- (1) Verifica que el micrófono de los auriculares no se encuentre silenciado.
- (2) Verifica el audio y asegúrate de que tus auriculares son el dispositivo por defecto. Por favor, ve a la página 6 y 7 para más información específica para configuraciones de sonido.
- (3) Asegúrate de que tu dispositivo es compatible con los auriculares. Los auriculares EKSA E1000 WT no son compatibles con Xbox®360 y la versión anterior de Xbox®One requiere un adaptador Microsoft adicional (no incluido).
- (4) Si todo lo anterior ha sido verificado y los auriculares son compatibles con el dispositivo, pero el micrófono aún no funciona, por favor contáctanos (info@eksa.net).



Contenuti nel Pacchetto

- ① EKSA E1000 WT Wireless Cuffie da Gioco
- ② 3,5 mm Cavo Audio
- ③ Cavo di Ricarica di Tipo C
- ④ USB Dongle
- ⑤ Custodia per Trasporto
- ⑥ Manuale per Utente

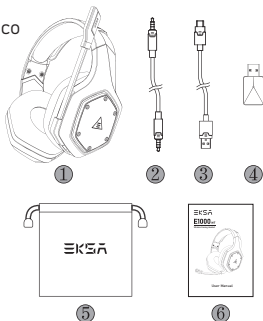

Specifiche



Dimensioni: 50 mm
 Impedenza dell'Unità (Ω): 32 Ω
 Intervallo di Frequenza: 20 Hz - 20 kHz
 Sensibilità (dB/mW): 105 \pm 3 dB



Tipo: Batteria al Litio
 Tempo di Utilizzo: Fino a 36 ore (luce spenta)
 Potenza Nominale: 5 V $\overline{=}$ 1 A
 Tempo di Ricarica: 2,5 Ore



Tipo: Microfono a Condensatore
 Schema Polare: Omnidirezionale
 Sensibilità: -42 \pm 3 dB
 Impedenza: 2,2 K Ω



Panoramica del Prodotto

- ① Cuscino per Testa
- ② Regolazione della Lunghezza
- ③ Luci RGB Colorate
- ④ Microfono Girevole
- ⑤ Cuscinetti per Orecchie
- ⑥ USB 2,4G Dongle
- ⑦ 3,5 mm a 3,5 mm Cavo Audio
- ⑧ Regolatore di Volume
- ⑨ Pulsante Muto di Microfono / Pulsante ENC
- ⑩ Pulsante di Accensione / Spegnimento / Pulsante Multifunzionale
- ⑪ Indicatore di Stato
- ⑫ 3,5 mm Interfaccia in Modalità Cablata
- ⑬ Indicatore di Ricarica
- ⑭ Porta di Ricarica di Tipo C

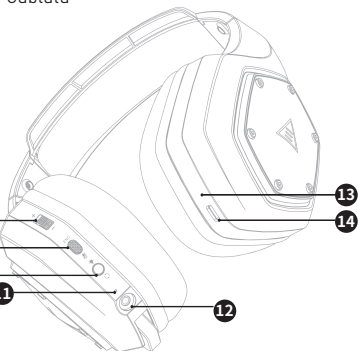
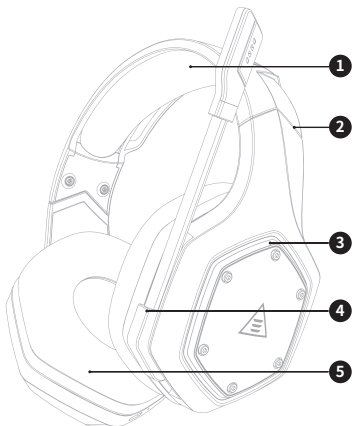

6



7



Guida d'Operazione



Rotella di Controllo del Volume:



Scorrere verso l'alto: Volume +



Scorrere verso il basso: Volume -



Pulsante di Microfono:

ENC



Premere per 3 secondi: ENC on/ off



Fare clic su: Microfono on/ off



Pulsante di Accensione:



Premere per 3 secondi: Power on / off



Fare clic su: Suono Surround on / off



Doppio clic: Luce on / off

Modalità Cablata:

Quando il cavo audio da 3,5 mm si collega, la cuffia si spegnerà automaticamente. Solo il controllo del volume funziona mentre tutti gli altri pulsanti no.



Caratteristiche Principali

1. EKSA VoicePure ENC

Perfezioni la Sua comunicazione di gioco con EKSA VoicePure ENC. Isola la Sua voce dal rumore intorno a lei con un microfono con cancellazione del rumore, eliminando fino al 96% del fastidioso rumore di fondo. Suonerà in modo naturale e chiaro nelle chat in-game, offrendoLe un vantaggio competitivo in più.

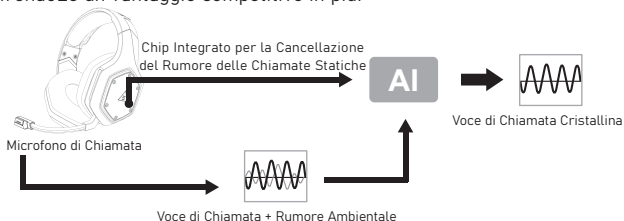

2. EKSA 7.1 SoundBase

EKSA 7.1 SoundBase offre un'esperienza audio senza rivali con un suono potente e coinvolgente. Ogni passo furtivo e ogni colpo di pistola esplosivo viene riprodotto con un posizionamento accurato e una chiarezza sorprendente, creando un campo di battaglia realistico. La funzione plug-and-play significa nessun problema aggiuntivo per ottenere un'esperienza di gioco davvero coinvolgente attraverso le piattaforme - inclusi PS®4, PS®5, Switch™ e PC. Per personalizzare i Suoi effetti sonori preferiti, scarichi semplicemente il driver dal nostro sito ufficiale (<https://www.eksa.net/download>).

Nota: EKSA SoundBase Software supporta solo Windows®.

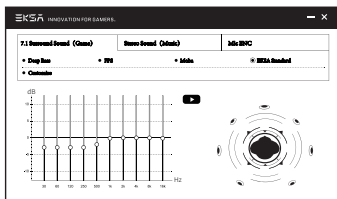
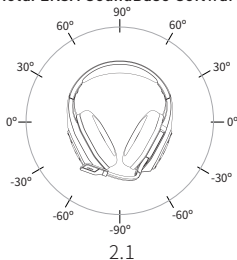



Caratteristiche Principali

3. Ampia Compatibilità

Dotato di cavo audio da 3,5 mm e USB Dongle, compatibile con PS®5, PS®4, Xbox® One, Nintendo Switch™, PC, Laptop, Mac, dispositivi mobili, ecc.

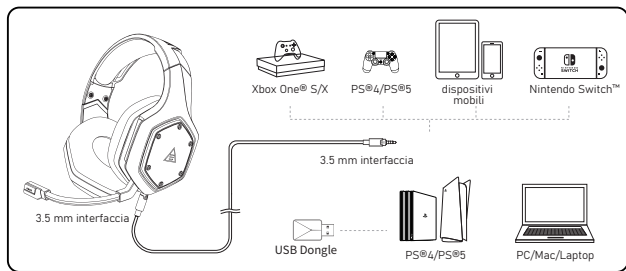

4. Cambiare Modalità di Suono a Un Tasto

Questo pulsante si trova sul guscio per orecchie e Le consente di passare da 7.1 suono surround alla modalità gioco o dallo stereo alla modalità musica. È semplice e comodo da usare.

Nota: quando si cambia la modalità di suono, verrà emesso un messaggio vocale di "surround sound on / off".

**Pulsante di Commutazione
della Modalità Audio**

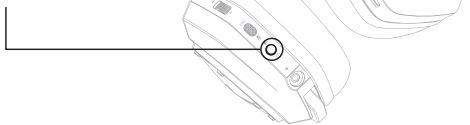



Impostazioni di USB Dongle

Segua i passaggi seguenti per assicurarsi che la cuffia EKSA E1000 WT sia il dispositivo audio predefinito.

Windows®:

Impostazioni Audio:



[Pannello di Controllo] ↓
[Hardware e Suono] ↓
[Suono] ↓
[Playback] ↓
[EKSA E1000 WT
(Impostare come Dispositivo Predefinito)]



Impostazioni del Microfono:





[Pannello di Controllo] ↓
[Hardware e Suono] ↓
[Suono] ↓
[Registrazione] ↓
[EKSA E1000 WT
(Impostare come Dispositivo Predefinito)]



macOS:



[Preferenze di Sistema] → [Suono] 
 [Entrada] → [EKSA E1000 WT]
[Output] → [EKSA E1000 WT]





Come Si Usa

PlayStation® 4 / PlayStation® 5:

Collegi il USB Dongle o il cavo audio da 3,5 mm al Suo controller PS®4/PS®5. Quindi segua i passaggi seguenti per controllare le impostazioni audio per assicurarsi che la Sua PS®4/PS®5 passi automaticamente alla riproduzione dell'audio e accenda il microfono.

PS®4

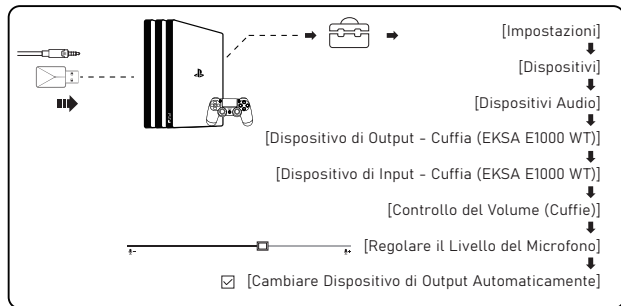

PS®5

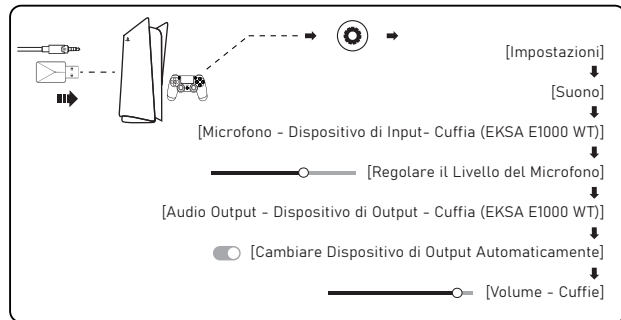



Come Si Usa

Xbox One® S/X:

Per lavorare sulla NUOVA versione del controller Xbox One® S/X, può connettere direttamente la Sua cuffia al controller tramite il cavo audio da 3,5 mm.

Note: 1. La cuffia non è compatibile con Xbox®360.

2. La vecchia versione di Xbox® One necessita di un adattatore Microsoft (non incluso).

Guida per Utenti Xbox®

Il controller ha un jack da 3,5 mm:
non è necessario alcun adattatore



Xbox One® S/X controller

Il controller non ha un jack da 3,5 mm:
è necessario un adattatore Microsoft
(non incluso)

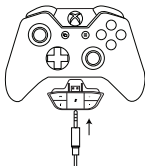

Xbox® One controller (vecchia versione)



FAQ

Q1: La mia cuffia non emette suoni.

- (1) Innanzitutto, si assicuri di aver collegato correttamente la cuffia al Suo dispositivo. Se ciò non funziona, controlli le impostazioni audio per assicurarsi di abilitare gli altoparlanti e di non disattivare l'audio del dispositivo, quindi controlli il volume del dispositivo e della cuffia per assicurare che sia a un livello adeguato.
- (2) Scolleghi il trasmettitore USB o il cavo audio da 3,5 mm e lo ricollegli; pulisca lo sporco o la polvere sul trasmettitore USB o sull'interfaccia da 3,5 mm; riconnetta la cuffia al dispositivo e verifichi se il microfono funziona.
- (3) Se il trasmettitore USB lampeggia rapidamente in blu, tenga il trasmettitore dov'è e spenga la cuffia, quindi prema il pulsante di accensione per 6 secondi. Non rilasci il dito finché non sente un avviso vocale di "pairing", il che significa che l'accoppiamento è riuscito ora.

Q2: Dopo aver collegato la cuffia al mio computer, non posso utilizzare il suo microfono.

- (1) Vada al pannello di controllo > Suono > Input. Scelga il microfono della cuffia come microfono predefinito.
- (2) Verifichi che il microfono della cuffia non sia muto.

Q3: Le persone dall'altra parte non possono sentirmi.

- (1) Verifichi che il microfono della cuffia non sia muto.
- (2) Controlli l'audio e si assicuri che la Sua cuffia sia il dispositivo predefinito. Si prega di fare riferimento a pagina 6 e 7 per informazioni più specifiche sulle impostazioni suono.
- (3) Si assicuri che il Suo dispositivo sia compatibile con la cuffia. La cuffia EKSA E1000 WT non è compatibile con Xbox®360 e la versione precedente di Xbox®One richiede un adattatore microsoft aggiuntivo (non incluso).
- (4) Se tutti questi sono stati controllati e la cuffia è compatibile con il dispositivo mentre il microfono continua a non funzionare, ci contatti (info@eksa.net).



Conteúdo do pacote

- ① Fone de ouvido sem fio para jogos EKSA E1000 WT
- ② Cabo de áudio de 3,5 mm
- ③ Cabo de carregamento tipo C
- ④ Adaptador USB de WIFI
- ⑤ Bolsa de transporte
- ⑥ Manual do usuário

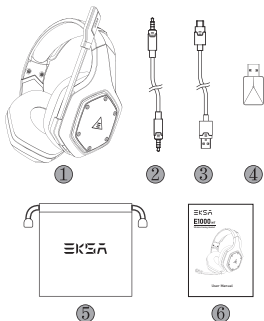

Especificações



Tamanho: 50 milímetros
 Impedância da unidade (Ω): 32 Ω
 Faixa de frequência: 20 Hz - 20 kHz
 Sensibilidade (dB/mW): 105 \pm 3 dB



Tipo: bateria de lítio
 Tempo de uso: até 36 horas (luz apagada)
 Potência nominal: 5 V $\overline{\text{---}}$ 1 A
 Tempo de carregamento: 2,5 H



Tipo: Microfone Condensador
 Padrão Polar: Omnidirecional
 Sensibilidade: -42 \pm 3 dB
 Impedância: 2,2 K Ω



Visão geral do produto

- ① Almofada de cabeça
- ② Ajuste de comprimento
- ③ Luzes coloridas RGB
- ④ Microfone rotativo
- ⑤ Almofadas de ouvido
- ⑥ Adaptador USB 2.4G de wifi
- ⑦ Cabo de áudio de 3,5 mm a 3,5 mm
- ⑧ Ajustador de volume
- ⑨ Botão Mic Mute/Botão ENC
- ⑩ Botão liga/desliga/
botão multifuncional
- ⑪ Indicador de status
- ⑫ Interface de modo com fio de 3,5 mm
- ⑬ Indicador de carga
- ⑭ Porta de carregamento tipo C

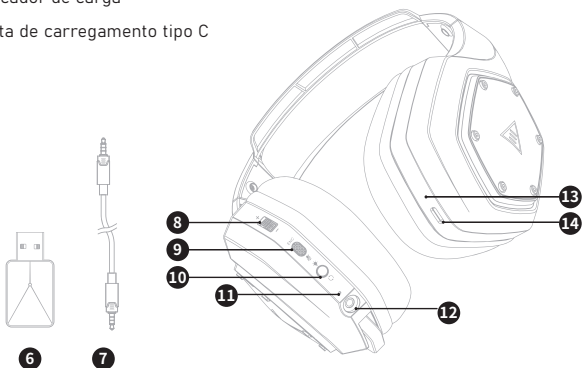
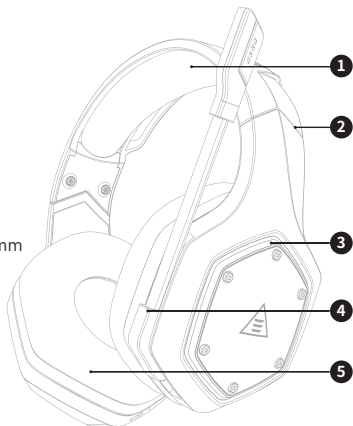



Guia de operação



Roda de controle de volume:



Rolar para cima: Volume +



Role para baixo: Volume -



Botão do microfone:

ENC



Pressione por 3 segundos: ENC on/off



Clique: Microfone ligado/desligado



Botão de energia:



Pressione por 3 segundos: ligar/desligar



Clique: Som Surround ligado/desligado



Clique duas vezes: Luz ligada/desligada

Modo com fio:

Quando o cabo de áudio de 3,5 mm for conectado, o fone de ouvido será desligado automaticamente. Apenas o controle de volume funciona enquanto todos os outros botões não.



Principais características

1. EKSA VoicePure ENC

Aperfeiçoe a comunicação do seu jogo com o EKSA VoicePure ENC. Ele isola sua voz do ruído ao seu redor com um microfone com cancelamento de ruído, eliminando até 96% do ruído de fundo perturbador. Você soará natural e claro nos bate-papos no jogo, dando a você uma vantagem competitiva extra.

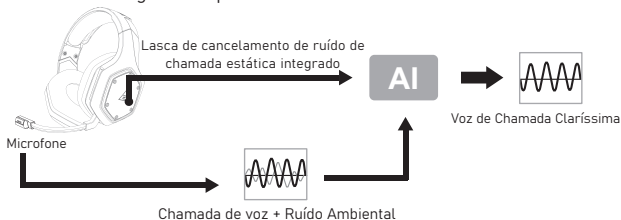

2. EKSA 7.1 SoundBase

O EKSA 7.1 SoundBase oferece uma experiência de áudio incomparável com som envolvente. Cada passo sorrateiro e cada tiro explosivo são reproduzidos com posicionamento preciso e clareza impressionante, criando um campo de batalha realista. O recurso plug-and-play significa que não há problemas extras para obter uma experiência de jogo verdadeiramente imersiva em todas as plataformas - incluindo PS®4, PS®5, Switch™ e PC. Para personalizar seus efeitos sonoros preferidos, basta baixar o driver em nosso site oficial (<https://www.eksa.net/download>).

Nota: O software EKSA SoundBase é compatível apenas com Windows®.

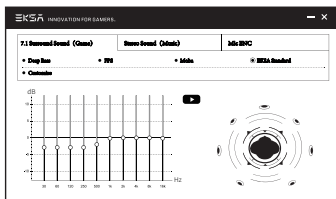
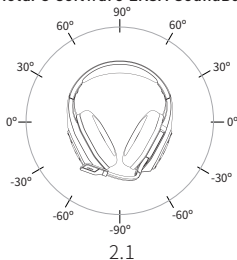



Principais características

3. Ampla Compatibilidade

Equipado com cabo de áudio de 3,5 mm e adaptador USB de Wifi, compatível com PS®5, PS®4, Xbox® One, Nintendo Switch™, PC, Laptop, Mac, dispositivos móveis, etc.

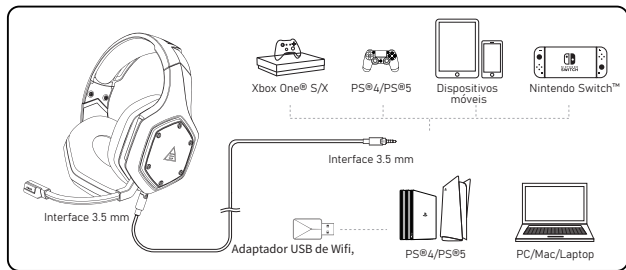

4. Interruptor de modo de som de uma tecla

Este botão está na concha do ouvido, permitindo alternar do som envolvente 7.1 para o modo de jogo ou estéreo para o modo de música. É simples e conveniente de operar.

Nota: quando alternar o modo de som, você ouvirá um aviso de voz "surround sound on / off".

Botão de comutação do modo de som

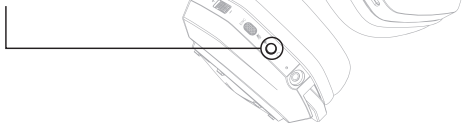



Configurações do Adaptador USB de Wifi,

Siga as etapas abaixo para garantir que seu fone de ouvido EKSA E1000 WT seja o dispositivo de áudio padrão.

Windows®:

Configurações de áudio:



[Painel de controle] ↓
[Hardware e Som] ↓
[Som] ↓
[Reprodução] ↓
[EKSA E1000 WT
(definido como dispositivo padrão)]



Configurações do microfone:





[Painel de controle] ↓
[Hardware e Som] ↓
[Som] ↓
[Reprodução] ↓
[EKSA E1000 WT
(definido como dispositivo padrão)]



macOS:



[Preferências do Sistema] → [Som] 
 [Entrada] → [EKSA E1000 WT]
[Saída] → [EKSA E1000 WT]





Como usar

PlayStation® 4 / PlayStation® 5:

Conecte o Adaptador USB de Wifi, ou o cabo de áudio de 3,5 mm ao seu controle PS®4/PS®5. Em seguida, siga as etapas abaixo para verificar as configurações de áudio e garantir que seu PS®4/PS®5 mude automaticamente para reproduzir áudio e ligue o microfone.

PS®4

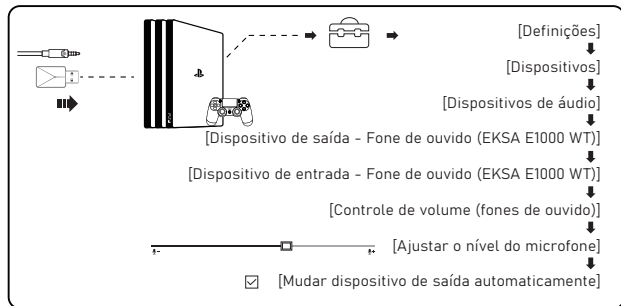

PS®5

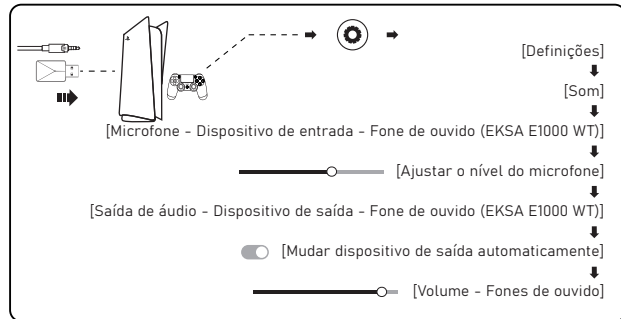



Como usar

Xbox One® S/X:

Para trabalhar na NOVA versão do controle Xbox One® S/X, você pode conectar diretamente seu fone de ouvido ao controle por meio do cabo de áudio de 3,5 mm.

Notas: 1. O fone de ouvido não é compatível com Xbox®360.

2. A versão antiga do Xbox® One precisa de um adaptador da Microsoft (não incluído).

Guia para utilizadores de Xbox®

O controlador tem um conector de 3,5 mm: não é necessário adaptador



Controlador Xbox One® S/X

O controlador não tem um conector de 3,5 mm: é necessário um adaptador Microsoft (não incluído)



Controlador Xbox® One (versão antiga)



Perguntas Frequentes

P1: Meu fone de ouvido não tem som.

- (1) Primeiro, verifique se você conectou o fone de ouvido corretamente ao seu dispositivo. Se isso não funcionar, verifique as configurações de áudio para garantir que você ative os alto-falantes e não silencie o dispositivo e, em seguida, verifique o volume do dispositivo e do fone de ouvido para garantir que esteja no nível adequado.
- (2) Desconecte o transmissor USB ou o cabo de áudio de 3,5 mm e reconecte-o; limpe a sujeira ou poeira no transmissor USB ou na interface de 3,5 mm; reconecte o fone de ouvido ao dispositivo e verifique se o microfone funciona.
- (3) Se o transmissor USB estiver piscando a luz azul rapidamente, mantenha o transmissor onde está, desligue o fone de ouvido e pressione o botão liga/desliga por 6 segundos. Não solte o dedo até ouvir um aviso de voz de "emparelhamento", o que significa que o emparelhamento foi bem-sucedido agora.

P2: Depois de conectar o fone de ouvido ao computador, não consigo usar o microfone.

- (1) entra no painel de controle>Som>Entrada. Escolha o microfone do fone de ouvido como o microfone padrão.
- (2) Verifique se o microfone do fone de ouvido não está mudo.

P3: As pessoas do outro lado não podem me ouvir.

- (1) Verifique se o microfone do fone de ouvido não está mudo.
- (2) Verifique o áudio e certifique-se de que seu fone de ouvido seja o dispositivo padrão. Consulte as páginas 6 e 7 para obter informações mais específicas sobre configurações de som.
- (3) Certifique-se de que seu dispositivo seja compatível com o fone de ouvido. O fone de ouvido EKSA E1000 WT não é compatível com o Xbox®360 e a versão antiga do Xbox®One requer um adaptador microsoft extra (não incluído).
- (4) Se tudo isso foi verificado e o fone de ouvido é compatível com o dispositivo enquanto o microfone ainda não funciona, entre em contato conosco (info@eksa.net).



Paket İÇeriĐi

- ① EKSA E1000 WT Kablosuz Oyun KulaklıĐı
- ② 3,5 mm Ses Kablosu
- ③ Type C Şarj Kablosu
- ④ USB Aygıtı
- ⑤ Taşıma Çantası
- ⑥ Kullanım Kılavuzu

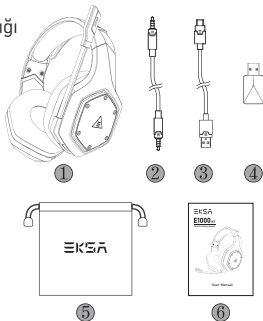

Özellikler



Boyut: 50 mm
 Birim direnci (Ω): 32 Ω
 Frekans Aralığı: 20 Hz - 20 kHz
 Hassasiyet (dB/mW) : 105 \pm 3 dB



Tür: Lityum Pil
 Kullanım Süresi: 36 saate kadar (ışık kapalı)
 Nominal Güç: 5 V $\overline{=}$ 1 A
 Şarj Süresi: 2,5 H



Tür: Kondansatörlü Mikrofon
 Kutup Deseni: Çok Yönlü
 Hassasiyet: -42 \pm 3 dB
 Direnç: 2.2 K Ω



Ürüne Genel Bakış

- ① Kafa Tamponu
- ② Uzunluk Ayarı
- ③ Renkli RGB Işıklar
- ④ Dönebilen Mikrofon
- ⑤ Kulak Tamponu
- ⑥ USB 2.4G Aygıtı
- ⑦ 3,5 mm - 3,5 mm Ses Kablosu
- ⑧ Ses Ayarlayıcı
- ⑨ Mikrofon Sessize Alma Düğmesi / ENC Düğmesi
- ⑩ Güç Açma / Kapatma Düğmesi / Çok İşlevli Düğme
- ⑪ Durum Göstergesi
- ⑫ 3.5 mm Kablolu Mod Arayüzü
- ⑬ Şarj göstergesi
- ⑭ Type-C Şarj Bağlantı Noktası

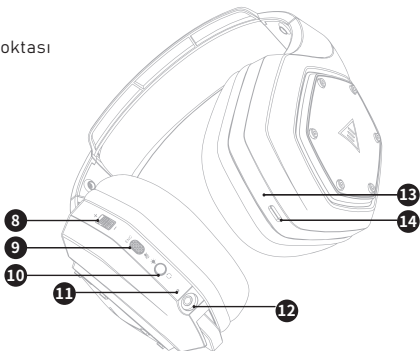
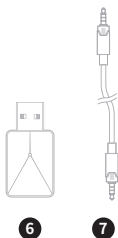
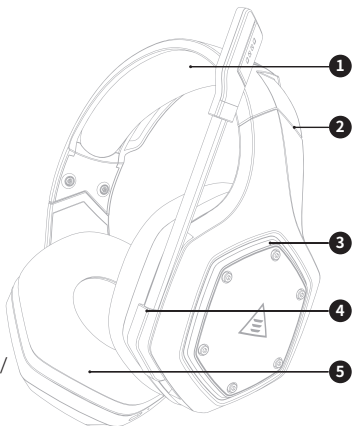



Kullanım Rehberi



Ses Kontrol Çarkı:



Yukarı çevir: Ses +



Aşağı çevir: Ses -



Mikrofon Düğmesi:

ENC



3 saniye basılı tutma: ENC açık / kapalı



Tıklama: Mikrofon açık / kapalı



Güç düğmesi:



3 saniye basılı tutma: Açma/kapama



Tıklama: Surround Ses açık / kapalı



Çift tıklama: Işık açık / kapalı

Kablolu Mod:

3,5 mm ses kablosu takıldığında, kulaklık otomatik olarak kapanacaktır. Yalnızca ses kontrolü çalışırken diğer tüm düğmeler çalışmaz.



Ana Özellikler

1. EKSA VoicePure ENC

EKSA VoicePure ENC ile oyun iletişiminizi kusursuz hale getirin. Gürültü önleyici bir mikrofonla sesinizi etrafınızdaki gürültüden yalıtır ve dikkat dağıtıcı arka plan gürültüsünü %96'ya kadar ortadan kaldırır. Size ekstra rekabet avantajı sağlayacak olan doğal ve net oyun içi sohbetler yapabileceksiniz.

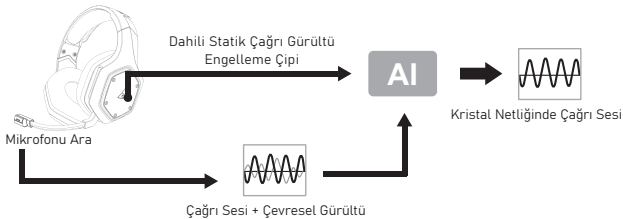

2. EKSA 7.1 SoundBase

EKSA 7.1 SoundBase Teknolojisi, güçlü ve kapsayıcı sesle rakipsiz bir ses deneyimi sunar. Atılan her sinsi adım ve her patlayıcı silah sesi, doğru konumlandırma ve müthiş netlikle yeniden üretilerek gerçeğe yakın bir savaş alanı yaratmaktadır. Tak ve çalıştır özelliği, ekstra hiçbir zorluk olmadan, PS®4, PS®5, Switch™ ve PC de dahil olmak üzere, platformlar arasında gerçek sürükleyici bir oyun deneyimi elde edebileceğiniz manasına gelir. Tercih ettiğiniz ses efektlerini özelleştirmek için resmi web sitemizden (<https://www.eksa.net/download>) sürücüyü indirmeniz yeterlidir.

Not: EKSA SoundBase Yazılımı yalnızca Windows®'u destekler.

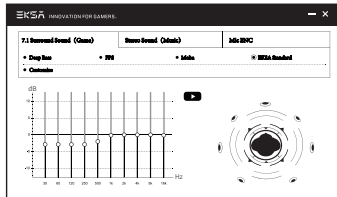
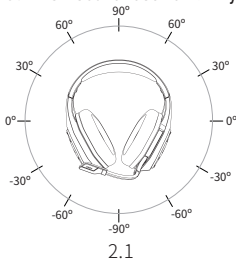



Ana Özellikler

3. Geniş Uyumluluk

PS®5, PS®4, Xbox® One, Nintendo Switch™, PC, Dizüstü Bilgisayar, Mac, mobil cihazlar vb. ile uyumlu 3,5 mm ses kablosu ve USB Aygıt ile donatılmıştır.

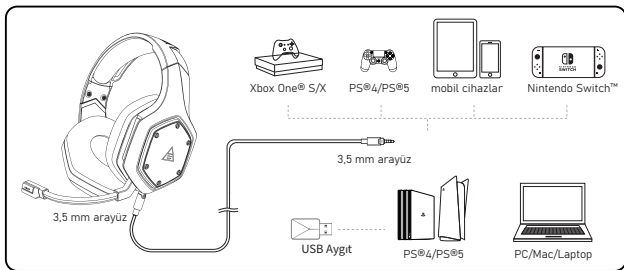

4. Tek Tuşla Ses Modu Anahtarı

Bu düğme kulaklığın üzerindedir ve 7.1 surround sesteki oyun moduna veya stereodan müzik moduna geçmenizi sağlar. Kullanımı basit ve kolaydır.

Not: Ses modunu değiştirirken, surround sound on / off sesli uyarısını duyarsınız.

Ses Modu Değiştirme Düğmesi

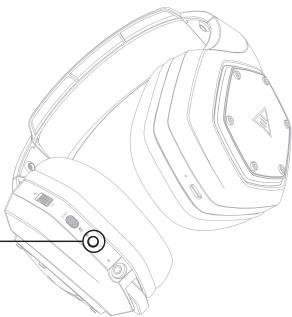



USB Aygıt Ayarları

EKSA E1000 WT kulaklığınızın varsayılan ses cihazı olduğundan emin olmak için aşağıdaki adımları izleyin.

Windows®:

Ses Ayarları:



[Kontrol Paneli] ↓
[Donanım ve ses] ↓
[Ses] ↓
[Geri çalma] ↓
[EKSA E1000 WT
(Varsayılan Cihaz Olarak Ayarla)]



Mikrofon Ayarları:



[Kontrol Paneli] ↓
[Donanım ve ses] ↓
[Ses] ↓
[Kayıt] ↓
[EKSA E1000 WT
(Varsayılan Cihaz Olarak Ayarla)]



macOS:



[Sistem Tercihleri] → [Ses] 
 [Ses] → [EKSA E1000 WT]
[Çıkış] → [EKSA E1000 WT]





Nasıl kullanılır

PlayStation® 4 / PlayStation® 5:

USB Aygıtı veya 3,5 mm ses kablosunu PS®4/PS®5 oyun konsolunuzla bağlayın. Ardından, PS®4/PS®5'inizin otomatik olarak ses çalmaya geçmesini ve mikrofonu açmasını sağlamak üzere ses ayarlarını kontrol etmek için aşağıdaki adımları izleyin.

PS®4

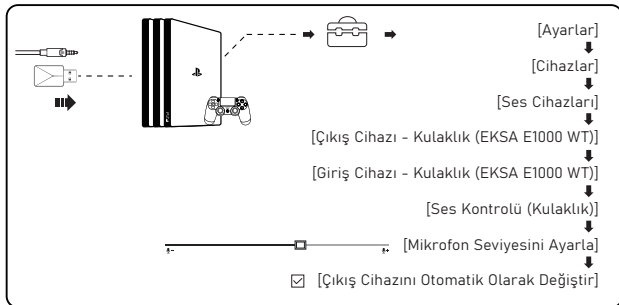

PS®5

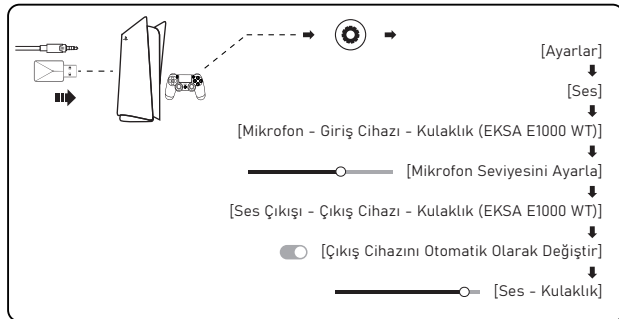



Nasıl kullanılır

Xbox One® S/X:

Xbox One® S/X oyun konsolunun YENİ sürümü üzerinde çalışmak için, kulaklığınızı 3,5 mm ses kablosuyla direkt olarak oyun konsoluna bağlayabilirsiniz.

Notlar: 1. Kulaklık, Xbox®360 ile uyumlu değildir.

2. Xbox® One'in eski sürümü için bir Microsoft adaptörü gereklidir (dahil değildir).

Xbox® Kullanıcıları için Kılavuz

Denetleyicide 3,5 mm jak bulunur:
adaptör gerekmez



Xbox One® S/X oyun kumandası

Denetleyicide 3,5 mm jak yok:
bir Microsoft bağdaştırıcısı gereklidir
(dahil değildir)



Xbox® One oyun kumandası (eski sürüm)



SSS

S1: Kulaklığımı ses gelmiyor.

- (1) Öncelikle kulaklığı cihazınıza doğru şekilde taktığınızdan emin olun. Bu işe yaramazsa, hoparlörlerinizi etkinleştirdiğinizden ve cihazınızın sesini kapatmadığınızdan emin olmak için ses ayarlarınızı kontrol edin, ardından uygun seviyede olduğundan emin olmak için cihazınızın ve kulaklığınızın ses seviyesini kontrol edin.
- (2) USB vericiyi veya 3,5 mm ses kablosunu çıkarın ve yeniden takın; USB vericideki veya 3,5 mm Arayüzündeki kırı veya tozu silin; kulaklığı cihaza yeniden takın ve mikrofonun çalışıp çalışmadığını kontrol edin.
- (3) USB verici hızlı bir şekilde mavi renkte yanıp sönüyorsa, vericiyi olduğu yerde tutun ve kulaklığınızı kapatın, ardından güç düğmesine 6 saniye boyunca basılı tutun. "Pairing" sesli uyarısını duyana kadar parmağınızı bırakmayın; bu, eşleştirmenin başarılı olduğu anlamına gelir.

S2: Kulaklığın bilgisayarıma bağladıktan sonra mikrofonunu kullanamıyorum.

- (1) Kontrol paneli>Ses>Giriş adımlarını izleyin. Kulaklığın mikrofonunu varsayılan mikrofon olarak seçin.
- (2) Kulaklığın mikrofonunun sessizde olmadığını kontrol edin.

S3: Karşı taraftaki insanlar beni duyamıyor.

- (1) Kulaklığın mikrofonunun sessizde olmadığından emin olun.
- (2) Sesi kontrol edin ve kulaklığınızın varsayılan cihaz olduğundan emin olun. Ses ayarlarıyla ilgili daha ayrıntılı bilgi için lütfen 6. ve 7. sayfaya bakın.
- (3) Cihazınızın kulaklıkla uyumlu olduğundan emin olun. EKSA E1000 WT kulaklık, Xbox®360 ile uyumlu değildir ve Xbox®One'in eski sürümü için ekstra bir Microsoft adaptörü (dahil değildir) gereklidir.
- (4) Tüm bunlar kontrol edildiyse ve mikrofon hala çalışmıyorken kulaklık cihazla uyumluysa lütfen bizimle iletişime geçin (info@eksa.net).

Limited Warranty/保証/Garantie Limitée/ Eingeschränkte Garantie/Ограниченная Гарантия/Garantía Limitada/Garanzia Limitata/Garantia Limitada/Sınırlı Garanti

Our friendly customer service team is ready and waiting to help. Feel free to contact us:

私たちのカスタマーサービスチームはいつでもお手伝いします。連絡先は次のとおり:

Notre amicale équipe de service à la clientèle est prête et attend de vous aider. N'hésitez pas à nous contacter :

Unser freundliches Kundenservice-Team ist bereit, Ihnen zu bedienen. So können Sie uns kontaktieren:

Наша дружелюбная команда обслуживания клиентов готова и ждет помощи. Не стесняйтесь обращаться к нам:

Nuestro amable equipo de servicio al cliente está listo y esperando para ayudarlo. Bienvenido a contactarnos:

Il nostro cordiale team di assistenza clienti è pronto e in attesa di aiutare. Non esitate a contattarci:

Nossa equipe amigável de atendimento ao cliente está pronta e esperando para ajudar. Sinta-se à vontade para nos contatar:

Güler yüzlü müşteri hizmetleri ekibimiz yardıma hazır ve bekliyor. Bizimle iletişime geçmekten çekinmeyiniz:

Global:

☎ +85269404955(Mon to Fri 9:00 am-6:30 pm, UTC +8 HKT)

✉ info@eksa.net

🌐 www.eksa.net/warranty

India:

☎ +918929369620(Mon to Fri 9:30 am-5:30 pm, IST)

✉ support@eksa.co.in

Manufacturer: YI ZHAO (SHENZHEN) CO., LIMITED

Add.: 6th Floor, T3 Creative Building, Shenzhen Colorful Huiwei Cultural and Creative Expo City, No.5010 Baoan Avenue, Caowei Community, Hangcheng Street, Baoan District, Shenzhen City, Guangdong Province, China

UK REP

APEX CE SPECIALISTS LIMITED

Add.: 89 Princess Street, Manchester, M1 4HT, UK

Tel.: +441616371080

Email: info@apex-ce.com

EC REP

C&E Connection E-Commerce (DE) GmbH

Add.: Zum Linnegraben 20, 65933, Frankfurt am Main, Germany

Tel.: +4906927246648

Email: info@ce-connection.de



Points de collecte sur www.quefairedemesdechets.fr
Privilégiez la réparation ou le don de votre appareil !



FCC ID: 2A25A-E1000

FCC ID:2A25A-EHA05

Made in China

INNOVATION FOR GAMERS