

USER GUIDE

LiFePO4 Battery System for Households



LiFePO4 Battery System for Households

Contents

1 ABOUT THIS MANUAL	1
1.1 Purpose	1
1.2 Scope	1
1.3 Safety Instructions	1
2 INTRODUCTION	2
2.1 Features.....	2
2.2 Product Overview	2
2.3 Specifications	4
2.4 Recommended Settings	4
3. INSTALLATION	5
3.1 Unpacking and Inspection	5
3.2 Mounting the Unit	5
3.3 Connection for Parallel Mode	5
4. OPERATION	7
4.1 Switch On/Off.....	7
4.2 LCD Display icons	7
4.3 BMS information Page	8
4.4 Fault Code Table	9
4.5 DIP switch SW1-SW4 Description	10
5. EMERGENCY SITUATIONS	11
5.1 Fire	11
5.2 Leaking Batteries	11
5.3 Wet Batteries	11
5.4 Damaged Batteries	11
5.5 Warranty	11

1 ABOUT THIS MANUAL

1.1 Purpose

This manual describes the introduction, installation, operation and emergency situations of the battery bank. Please read this manual carefully before installations and operations. Keep this manual for future reference.

1.2 Scope

This manual provides safety and installation guidelines as well as information on tools and wiring.

1.3 Safety Instructions



WARNING: This chapter contains important safety and operating instructions. Read and keep this manual for future reference.

1. Before using the unit, read all instructions and cautionary markings on the unit, the batteries and all appropriate sections of this manual.
2. CAUTION --- To reduce risk of injury, damage, even burst, please use it following using manual. In case of causing personal
3. Do not disassemble the battery. Take it to a qualified service center when service or repair is required. Incorrect re-assembly may result in a risk of fire.
4. To reduce risk of electric shock, disconnect all wirings before attempting any maintenance or cleaning. Turning off the unit will not reduce this risk.
5. CAUTION – Only qualified personnel can install this device with inverter.
6. For optimum operation of this battery, please follow required spec to select appropriate cable size.
7. Be very cautious when working with metal tools on or around batteries. A potential risk exists to drop a tool to spark or short circuit batteries or other electrical parts and could cause an explosion or fire.
8. Please strictly follow installation procedure.
9. To support full output load, at least 2 sets for inverter larger than 6KVA in parallel connection.
10. **GROUNDING INSTRUCTIONS** - This System should be connected to a permanent grounded wiring system. Be sure to comply with local requirements.
11. NEVER cause AC output and DC input short circuited. Do not connect to the mains when DC input short circuits.
12. Warning!! Only qualified service persons are able to service this device.
13. Battery should be installed indoor and kept away from water, high temperature mechanical force and flames.
14. Do not install the battery in any environment of temperature below 0°C or over 55°C, and humidity over 80%.
15. Do not put any heavy objects on the battery.

1.4 Can be connected in parallel

1. The batteries can be connected in parallel. Series connection is not allowed.

Use in upright position only.

2. The batteries are not allowed to connected with PWM controller for charging.

3. The batteries are allowed to connected with MPPT controller for charging, but the maximum PV voltage in the system must be less than 100Vdc.

Special Attention: Due to the built-in protection board of the lithium battery pack is with over-discharge protection function, it is strongly recommended to stop using the load when the battery pack is over-discharged. The battery pack cannot be repeatedly activated for discharge. Or the battery may be failed to be activated by the AC or PV activation cable (It requires a special charging activation method), so cannot be charged. Therefore, when the battery pack is low power, please charge the battery as soon as possible when main power or solar energy is available.

2. INTRODUCTION

The battery system main using solar power system for family house. It also have a with to controller the battery easily and protect our Household application timely.

2.1 Features

- LiFePO: Higher safe performance and longer cycle life.
- Multiple Protection: Built-in smart BMS, Breaker and Fuse.
- Flexible Installation: Movalbe type Floor-Mounted.
- Wide Compatibility: Compatible with leading inverter brands.
- High Scalability: Capacity up to 300kWh.
- Long Warranty: 7 Years.

2.2 Product OverView

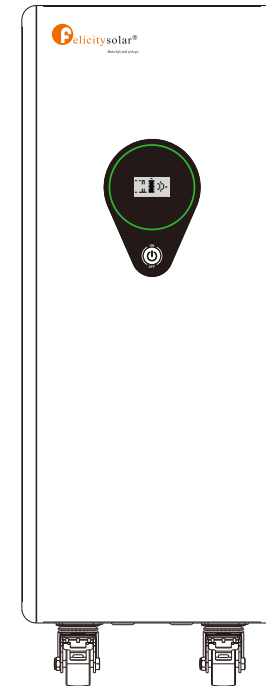

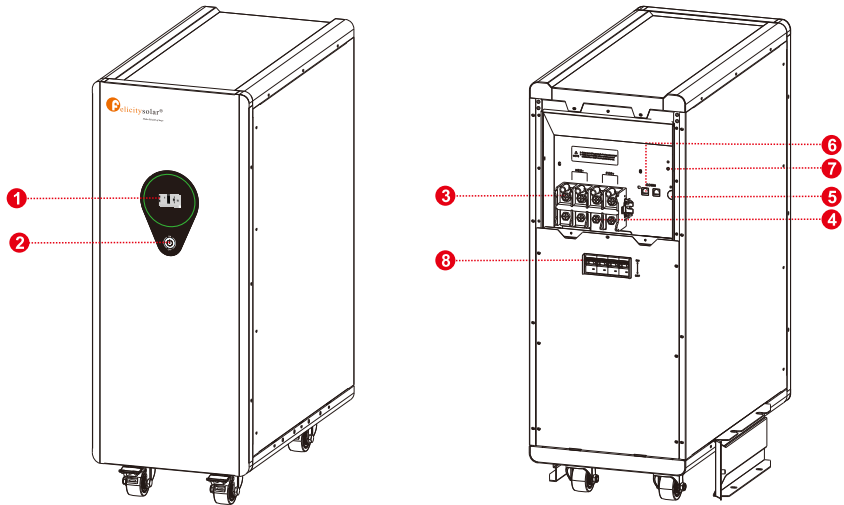

- 1. LCD display
- 2. Power On/Charging indicator
- 3. Battery Negative -
- 4. Battery Positive +
- 5. Switch
- 6. Communication port
- 7. Earth wire
- 8. Breaker

2.3 Specifications

Model	LPBA48500
Capacity	25kWh
Battery Type	LiFePO4
Nominal Voltage	51.2V
Operating Voltage	48-57.6V
Recommend Charge/Discharge Current[1]	≤200A
Recommend Charge/Discharge Power[1]	≤10,000W
Maximum Charge/Discharge Current(15s)	300A
Maximum Charge/Discharge Power(15s)	15,000W
Depth of Discharge(DOD)	≥ 95%
Scalability	Up to 12 units in parallel(300kWh)
Communication	RS485 / CAN
Protection Level	IP21
Cycle Life[2]	≥ 6000 Cycles
Charging Temperature Range	0-55 °C
Discharging Temperature Range	-20-60°C
Display	LCD+LED
Installation	Floor-Mounted
Protection	Built-in smart BMS, Breaker, Fuse
Warranty	10 years
Net Weight	215kg
Gross Weight	243kg
Product Dimension	718x380x990mm
Package Dimension	825x498x1162mm
[1] Recommend charge/discharge current/power is affected by temperature and SOC.	
[2] Test conditions: 0.2C Charging/Discharging @25°C , 80% DOD.	

2.4 Recommended Settings

Lithium battery pack is not same as lead-acid battery, so for the devices which you connect with the battery pack for charging or discharging, such as inverters, MPPT charger controllers or UPS, please implement pre-settings as recommended settings as below before you launched them.

Setting	LPBA48500
Max. Charging Voltage	57.6V
Floating charging Voltage	57.6V
Max. Charging Current	200A*N
Cut-off voltage	48V

Notes: "N" means the number of battery packs connected in parallel.

3. Installation Procedure

3.1 Setup Script

Step 1: Remove the wooden board from the outer box, leaving only the bottom pallet and product

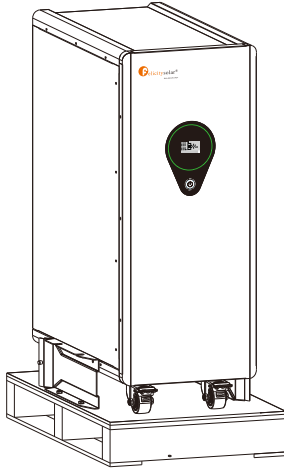

Step 2: Remove the fastening screws on the pallet fixture

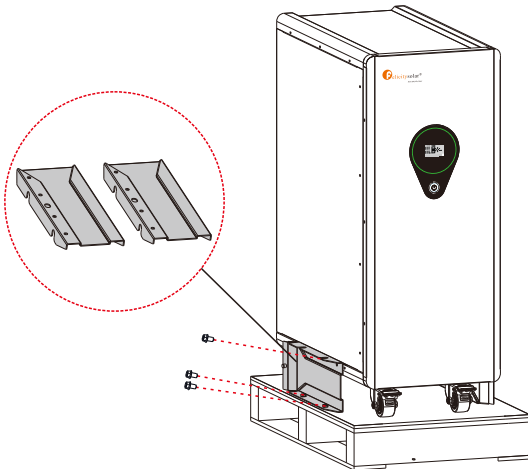

Step 3: Take out the fixed parts of the pallet, align them with the U-shaped holes at both ends of the pallet, and clamp them onto the pallet to form unloading steps

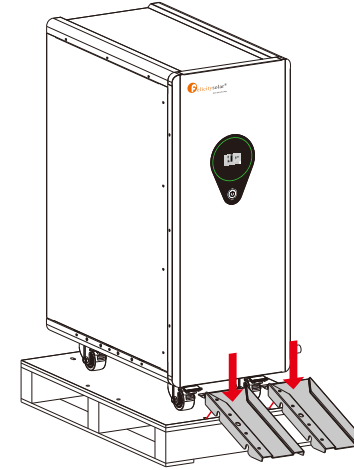

Step 4: Push the product down the pallet along the steps and move it to the installation position

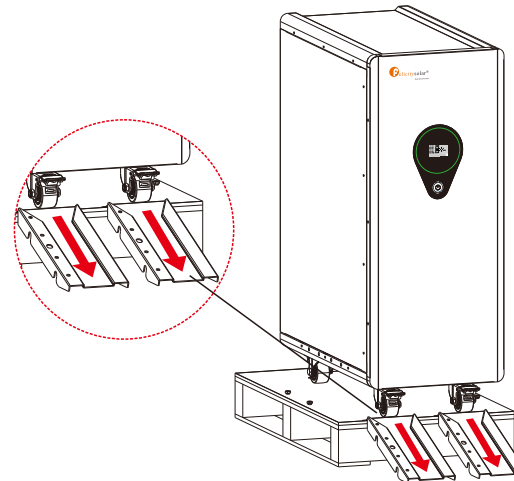

3. INSTALLATION

3.1 Unpacking and Inspection

Before installation, please inspect the unit. Be sure that nothing inside the package is damaged. You should have received the following items inside of package.

NO	NAME	SPECIFICATION	PICTURE
1	CAN com line	Used for communication between battery and PCS	
2	Communication line	Used for Communication among batteries	
3	Cables	Used for battery parallel connection Wire AWG#2	
4	User manual	User manual	
5	Guarantee card	Guarantee card	
6	RS485 com line	Used for communication between battery and PCS	
7	CAN/485 com line	Used for communication between battery and PCS	
8	90 degree wiring terminals	Spare for wiring at the output	

3.2 Mounting the Unit

Consider the following points before selecting where to install:

- Do not mount the battery on flammable construction materials.
- The ambient temperature should be between 0°C and 45°C to ensure optimal operation.
- The recommended installation position is to be adhered to the wall vertically.
- Be sure to keep other objects and surfaces as shown in the right diagram to guarantee sufficient heat dissipation and to have enough space for removing wires.

Please follow below steps to implement battery connection:

1. Assemble battery ring terminal based on recommended battery cable and terminal size.
2. Connect all battery packs as units requires. It's suggested to connect at least 2 sets for inverter larger than 10KVA in parallel connection.

Note: if you need the battery wake-up when the grid back, connect the battery with grid use power adapter and communication line 1 shown in the package list.

3.3 Connection for Parallel Mode

The LPBF series battery support to be connected in parallel for expansion. If you need one more battery bank work in parallel mode, connect the battery as shown in PIC 1.

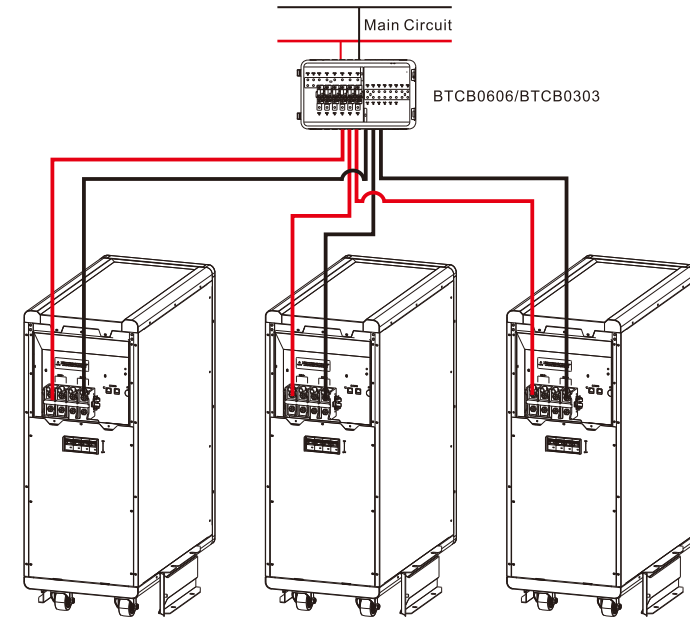

Step 1: The schematic diagram of the parallel connection of three battery packs is shown in Figure 1.

Note: After completing the above steps, arbitrarily select the positive and negative poles of one of the battery packs to output. After confirming the correct connection of the inverter, controller and battery, you can turn on any of the switches and use the battery group happily.

For pure off grid system ,the PV awake wire need to be connected with MPPT charge controller if the battery pack is charged by solar panels only . The connection diagram as below :

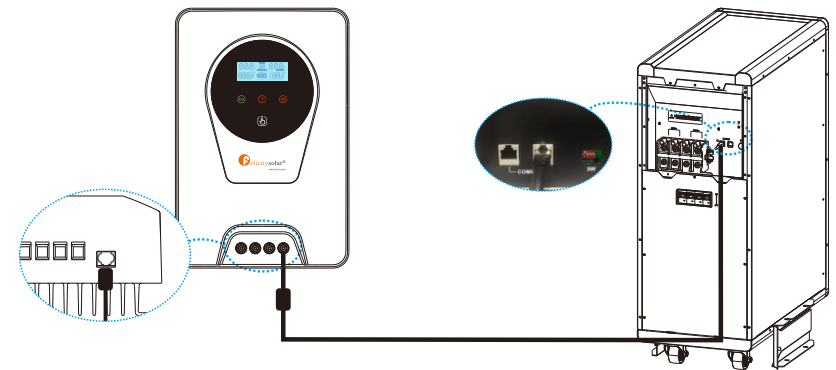

4. OPERATION

Once the batteries are connected well, close the breaker to the ON block, press On/Off button to enable the output of the battery pack.

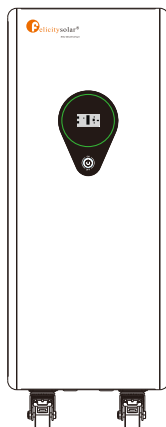

4.1 Switch On / Off

- 1.Switch on: press On/Off button to switch on the battery, then the battery will do self-inspection before enable output. The LCD will show the SOC.
- 2.Switch off: press and hold On/Off button for 1to3 seconds, the battery will shut down directly.

Description for Communication port

Picture	PIN	Description
	1	Trigger-GND
	2	Trigger-VCC
	3	CANL-PCS
	4	CANH-PCS
	5	RS485-B
	6	RS485-A
	7	CANL
	8	CANH

DIP SWITCH		
	1-4	Communication Address
	5	Termination Resister

4.2 LCD Display icons

Icon	Function description
Display Information	
	Indicates battery voltage.
	Indicates battery current or watt Short press the switch button to switch watt and current
	Indicate SOC.
Battery Information	
	Indicates battery level by 0-20%, 21-40%, 41-60%, 61-80%, 81-100%. (When charging, this icon is displayed for horse running; When discharging, the icon displays constant).
Fault information	
	Indicates a fault.
set information	
	Indicates settings.

4.3 BMS information Page

The basic information will be displayed in turn after power on.

BMS power on information	BMS version
BMS information is all on. 	Eg: "515" is the software version; "400" is the IAP version and temporary version; "02" is the countdown.

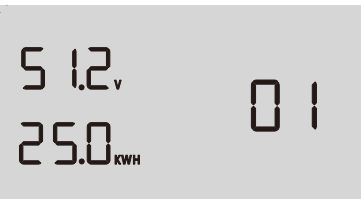
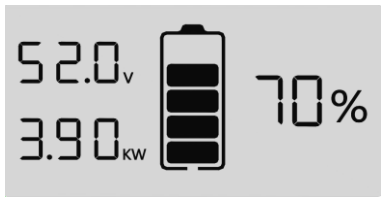
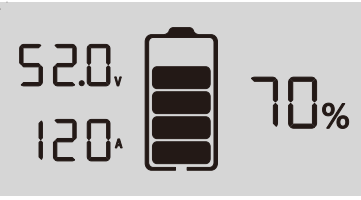
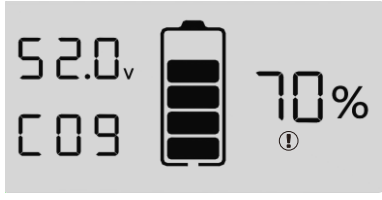
<p>BMS type Eg: Rated voltage is "51.2V"; model is "25.0KWH", "01" is the countdown.</p> 	<p>BMS data Eg: "52.0V" / "3.90KW" / "70%" refers to battery voltage, power and SOC.</p> 
<p>BMS data Eg: "52.0V" / "120A" / "70%" refers to battery voltage, current and SOC.</p> 	<p>BMS fault code / flag Eg: "52.0V" / "C09" / "70%" are battery voltage, fault code and SOC respectively, and Fault icon constant.</p> 

4.4 Fault Code Table

Fault Code	Fault information	Trouble Shooting
C01	Battery overvoltage	Restart the unit, if the error happens again, please return to repair center.
C02	Battery undervoltage	Restart the unit, if the error happens again, please return to repair center.
C03	Cell overvoltage	Restart the unit, if the error happens again, please return to repair center.
C04	Cell undervoltage	Restart the unit, if the error happens again, please return to repair center.
C05	Charge overcurrent	Restart the unit, if the error happens again, please return to repair center.
C06	Discharge overcurrent	Restart the unit, if the error happens again, please return to repair center.
C07	MOS overtemperature	1. The inner temperature is over the limitation. 2. Check whether the ambient temperature is too high.
C08	MOS undertemperature	1. The internal temperature is lower than the limit range. 2. Check whether the ambient temperature is too low.

C09	Cell overtemperature	Restart the unit, if the error happens again, please return to repair center.
C10	Cell undertemperature	Restart the unit, if the error happens again, please return to repair center.
C11	Abnormal current sampling	Restart the unit, if the error happens again, please return to repair center.
C12	Abnormal output impedance	Restart the unit, if the error happens again, please return to repair center.
C13	Parallel failed	1. Please check if single unit is installed to parallel system. 2. If this error happens during parallel installation, please check wires connection. If they are connected correctly, please finish parallel installation first, and then Restart the unit. 3. If the problem remains, please contact your installer.
C14	Output loss	1. Please check whether the circuit breaker is closed; 2. Please check whether the fuse is normal; 3. Restart the unit, If the error happens again, please return to repair center.

4.5 DIP switch SW1-SW4 Description

DIP switch SW1-SW4 Description ①					DIP switch SW5 Description ②	
Sw1	SW2	SW3	SW4	Remarks	SW5	Remarks
0	0	0	0	means ID=0, communication address is 0x00/0x10 ③	1	means connect 120Ω resistor
1	0	0	0	means ID=1, communication address is 0x01 ④		
0	1	0	0	means ID=2, communication address is 0x02	0	means disconnect 120Ω resistor
1	1	0	0	means ID=3, communication address is 0x03		
0	0	1	0	means ID=4, communication address is 0x04		
1	0	1	0	means ID=5, communication address is 0x05		
0	1	1	0	means ID=6, communication address is 0x06		
1	1	1	0	means ID=7, communication address is 0x07		
0	0	0	1	means ID=8, communication address is 0x08		
1	0	0	1	means ID=9, communication address is 0x09		
0	1	0	1	means ID=10, communication address is 0x0A		
1	1	0	1	means ID=11, communication address is 0x0B		
0	0	1	1	means ID=12, communication address is 0x0C		
1	0	1	1	means ID=13, communication address is 0x0D		
0	1	1	1	means ID=14, communication address is 0x0E		
1	1	1	1	means ID=15, communication address is 0x0F		

Remark ①: 1 in SW1-SW5 indicates ON status, and 0 indicates OFF status.

Remark ②: When multiple battery packs communicate, the last battery pack SW5 needs to be in the ON status, otherwise the communication may have interference.

Remark ③: When the battery pack ID is set to 0, it means stand-alone operation, and it is not necessary to detect whether the parallel condition is satisfied ⑤

Remark ④: When the battery pack ID is set to 1-15, it means that the parallel operation is required, and it is necessary to detect whether the parallel condition is satisfied ⑤

Remark ⑤: The parallel condition is that the difference between the battery voltage of the local battery and all the battery pack voltages is <3V, otherwise wait until the condition is satisfied

5. EMERGENCY SITUATIONS

Felicity cannot guarantee battery absolute safety.

5.1 Fire

In case of fires, make sure that the following equipment is available near the system.

- SCBA (self-contained breathing apparatus) and protective gear in compliance with the Directive on Personal Protective Equipment 89/686/EEC.
- NOVEC 1230, FM-200, or dioxide extinguisher

Batteries may explode when heated above 150°C. KEEP FAR AWAY from the battery if it catches fire.

5.2 Leaking Batteries

If the battery pack leaks electrolyte, avoid contact with the leaking liquid or gas. If one is exposed the leaked substance, immediately perform the actions described below.

- Inhalation: Evacuate the contaminated area, and seek medical attention.
- Contact with eyes: Rinse eyes with running water for 5 minutes, and seek medical attention.
- Contact with skin: Wash the affected area thoroughly with soap and water, and seek medical attention.
- Ingestion: Induce vomiting, and seek medical attention.

5.3 Wet Batteries

If the battery pack is wet or submerged in water, do not let people access it, and contact your supplier for help.

5.4 Damaged Batteries

Damaged batteries are not fit for use and are dangerous and must be handled with the utmost care. It may leak electrolyte or produce flammable gas. If the battery pack seems to be damaged, pack it in its original container, and then return it to your supplier.

5.5 Warranty

Products that are operated strictly in accordance with the user manual are covered by the warranty. Any violation of this manual may void the warranty.

Limitation of Liability

Any product damage or property loss caused by the following conditions, Felicity does not assume any direct or indirect liability.

- Product modified, design changed or parts replaced.
- Changed, or attempted repairs and erasing of series number or seals;
- System design and installation are not in compliance with standards and regulations;
- The product has been improperly stored in end user's premises;
- Transport damage (including painting scratch caused by movement inside packaging during shipping). A claim should be made directly to shipping or insurance company.