



**MB16AC/MB16ACR/
MB16ACM/MB16ACE**

Portable USB Monitor

Hybrid Signal Solution

User Guide

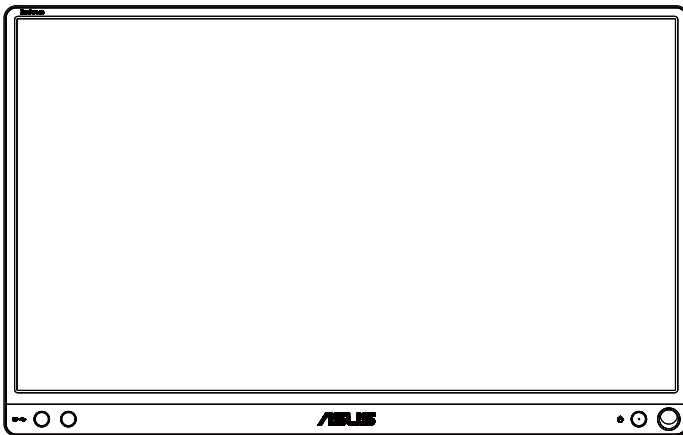

Table of contents

Notices.....	iii
Safety information	iv
Care & cleaning.....	v
Takeback services	vi
Caution	vi
1.1 Welcome!	1-1
1.2 Package contents.....	1-1
1.3 Monitor introduction	1-2
1.3.1 Front view	1-2
1.3.2 QuickFit Function	1-3
2.1 Monitor standing positions	2-1
2.2 Connect the USB monitor with system.....	2-2
2.3 Announcements	2-3
3.1 OSD (On-Screen Display) menu	3-1
3.1.1 How to reconfigure.....	3-1
3.1.2 OSD Function Introduction.....	3-2
3.2 Specifications.....	3-10
3.3 Troubleshooting (FAQ).....	3-11
3.4 Supported Timing List.....	3-13

Copyright © 2017 ASUSTeK COMPUTER INC. All Rights Reserved.

No part of this manual, including the products and software described in it, may be reproduced, transmitted, transcribed, stored in a retrieval system, or translated into any language in any form or by any means, except documentation kept by the purchaser for backup purposes, without the express written permission of ASUSTeK COMPUTER INC. ("ASUS").

Product warranty or service will not be extended if: (1) the product is repaired, modified or altered, unless such repair, modification or alteration is authorized in writing by ASUS; or (2) the serial number of the product is defaced or missing.

ASUS PROVIDES THIS MANUAL "AS IS" WITHOUT WARRANTY OF ANY KIND, EITHER EXPRESS OR IMPLIED, INCLUDING BUT NOT LIMITED TO THE IMPLIED WARRANTIES OR CONDITIONS OF MERCHANTABILITY OR FITNESS FOR A PARTICULAR PURPOSE. IN NO EVENT SHALL ASUS, ITS DIRECTORS, OFFICERS, EMPLOYEES OR AGENTS BE LIABLE FOR ANY INDIRECT, SPECIAL, INCIDENTAL, OR CONSEQUENTIAL DAMAGES (INCLUDING DAMAGES FOR LOSS OF PROFITS, LOSS OF BUSINESS, LOSS OF USE OR DATA, INTERRUPTION OF BUSINESS AND THE LIKE), EVEN IF ASUS HAS BEEN ADVISED OF THE POSSIBILITY OF SUCH DAMAGES ARISING FROM ANY DEFECT OR ERROR IN THIS MANUAL OR PRODUCT.

SPECIFICATIONS AND INFORMATION CONTAINED IN THIS MANUAL ARE FURNISHED FOR INFORMATIONAL USE ONLY, AND ARE SUBJECT TO CHANGE AT ANY TIME WITHOUT NOTICE, AND SHOULD NOT BE CONSTRUED AS A COMMITMENT BY ASUS. ASUS ASSUMES NO RESPONSIBILITY OR LIABILITY FOR ANY ERRORS OR INACCURACIES THAT MAY APPEAR IN THIS MANUAL, INCLUDING THE PRODUCTS AND SOFTWARE DESCRIBED IN IT.

Products and corporate names appearing in this manual may or may not be registered trademarks or copyrights of their respective companies, and are used only for identification or explanation and to the owners' benefit, without intent to infringe.

Notices

Federal Communications Commission Statement

This device complies with Part 15 of the FCC Rules. Operation is subject to the following two conditions:

- This device may not cause harmful interference, and
- This device must accept any interference received including interference that may cause undesired operation.

This equipment has been tested and found to comply with the limits for a Class B digital device, pursuant to Part 15 of the FCC Rules. These limits are designed to provide reasonable protection against harmful interference in a residential installation. This equipment generates, uses and can radiate radio frequency energy and, if not installed and used in accordance with manufacturer's instructions, may cause harmful interference to radio communications. However, there is no guarantee that interference will not occur in a particular installation. If this equipment does cause harmful interference to radio or television reception, which can be determined by turning the equipment off and on, the user is encouraged to try to correct the interference by one or more of the following measures:

- Reorient or relocate the receiving antenna.
- Increase the separation between the equipment and receiver.
- Connect the equipment to an outlet on a circuit different from that to which the receiver is connected.
- Consult the dealer or an experienced radio/TV technician for help.

Canadian Department of Communications Statement

This digital apparatus does not exceed the Class B limits for radio noise emissions from digital apparatus set out in the Radio Interference Regulations of the Canadian Department of Communications.

This class B digital apparatus complies with Canadian ICES-003.



As an Energy Star® Partner, our company has determined that this product meets the Energy Star® guidelines for energy efficiency.



Safety information

- Before setting up this Portable USB Monitor, carefully read all the documentation that came with the package.
- To prevent fire or shock hazard, never expose this Portable USB Monitor to rain or moisture.
- Never try to open this Portable USB Monitor cabinet.
- Before using this Portable USB Monitor, make sure all cables are correctly connected and the power cables are not damaged. If you detect any damage, contact your dealer immediately.
- Avoid dust, humidity, and temperature extremes. Do not place this Portable USB Monitor in any area where it may become wet. Place this Portable USB Monitor on a stable surface.
- Never push objects or spill liquid of any kind into the slots on this Portable USB Monitor cabinet.
- If you encounter technical problems with this Portable USB Monitor, contact a qualified service technician or your retailer.
- This Portable USB Monitor is powered by USB port which complies with LPS and SELV circuit according to IEC60950-1:2005.

Care & cleaning

- Cleaning. Turn your monitor off and unplug the cable. Clean the monitor surface with a lint-free, non-abrasive cloth. Stubborn stains may be removed with a cloth dampened with mild cleaner.
- Avoid using a cleaner containing alcohol or acetone. Use a cleaner intended for use with the LCD. Never spray cleaner directly on the screen, as it may drip inside the monitor and cause an electric shock.

The following symptoms are normal with the monitor:

- You may find slightly uneven brightness on the screen depending on the desktop pattern you use.
- When the same image is displayed for hours, an afterimage of the previous screen may remain after switching the image. The screen will recover slowly or you can turn off the Power Switch for hours.
- When the screen becomes black or flashes, or cannot work anymore, contact your dealer or service center to fix it. Do not repair the screen by yourself!

Conventions used in this guide



WARNING: Information to prevent injury to yourself when trying to complete a task.



CAUTION: Information to prevent damage to the components when trying to complete a task.



IMPORTANT: Information that you **MUST** follow to complete a task.



NOTE: Tips and additional information to aid in completing a task.

Where to find more information

Refer to the following sources for additional information and for product and software updates.

1. **ASUS websites**

The ASUS websites worldwide provide updated information on ASUS hardware and software products. Refer to <http://www.asus.com>

2. **Optional documentation**

Your product package may include optional documentation that may have been added by your dealer. These documents are not part of the standard package.

Takeback services

ASUS recycling and takeback programs come from our commitment to the highest standards for protecting our environment. We believe in providing solutions for our customers to be able to responsibly recycle our products, batteries and other components as well as the packaging materials.

Please go to <http://csr.asus.com/english/Takeback.htm> for detail recycling information in different region.

Caution

We suggest to use the attached pen (MB16AC/ACR/ACM) or any pen or stick that can fit in the hole at the corner as a simple stand for the monitor.

Please reserve at least 10cm/4 inch of the pen at the back of the monitor to stabilize.

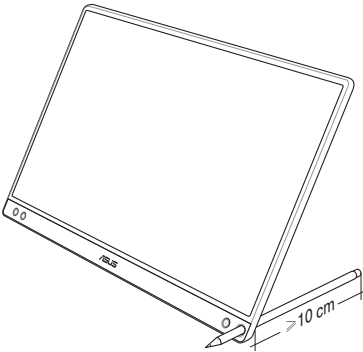

1.1 Welcome!

Thank you for purchasing the ASUS® Portable USB Monitor!

The latest ASUS Portable USB Monitor provides great portability and simplicity to your daily life, enhancing both of your viewing experience and style.

1.2 Package contents

Check your package for the following items:

- ✓ Portable USB Monitor
- ✓ Quick Start Guide
- ✓ Warranty Card
- ✓ USB Type-C Cable
- ✓ Smart cover
- ✓ USB Type-C to A adapter
- ✓ Pen (MB16AC/ACR/ACM)



-
- If any of the above items is damaged or missing, contact your retailer immediately.
 - Inbox pen is not included in the warranty.
-

1.3 Monitor introduction

1.3.1 Front view

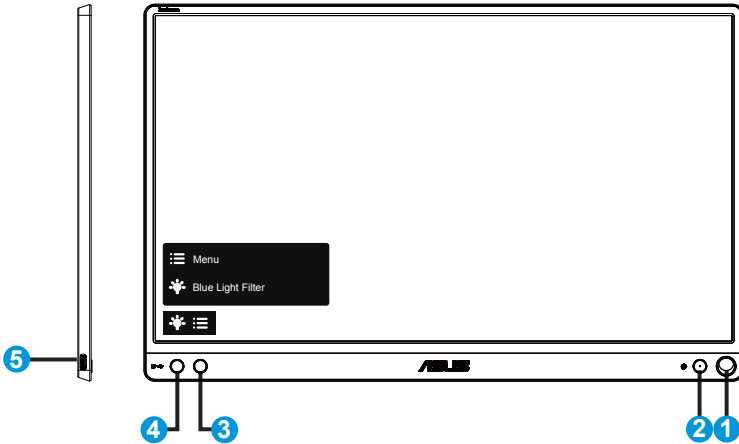

1. Pen hole
 - Use the attached pen to insert into the hole, the monitor can stand up directly without the smart cover.
2. Power button/Power LED
 - Press this button to turn the monitor on/off.
 - The color definition of the power indicator is as the below table.

Status	Description
Blue	ON
Amber	Standby mode
Dark	OFF

3. Menu button
 - Press this button to enter the OSD menu.
4. Blue light filter
 - Adjust the energy level of blue light emitted from LED backlight.
5. USB Type-C port

1.3.2 QuickFit Function

The QuickFit function contains two patterns: (1) Grid (2) Photo size.

1. Grid pattern: Facilitates designers and users to organize content and layout on one page and achieve a consistent look and feel.

Alignment grid 1 will be rotated automatically if auto rotation is enabled.

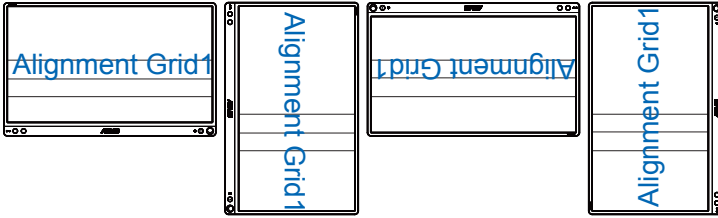

- Auto rotation function is only working under Windows OS by installing DisplayWidget software.



2. Photo size: Provides photographers and other users to accurately view and edit their photos in real size on the screen.

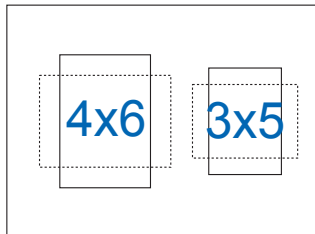

2.1 Monitor standing positions

MB16AC/ACR/ACM:

You can stand up the monitor by several positions with the smart cover.

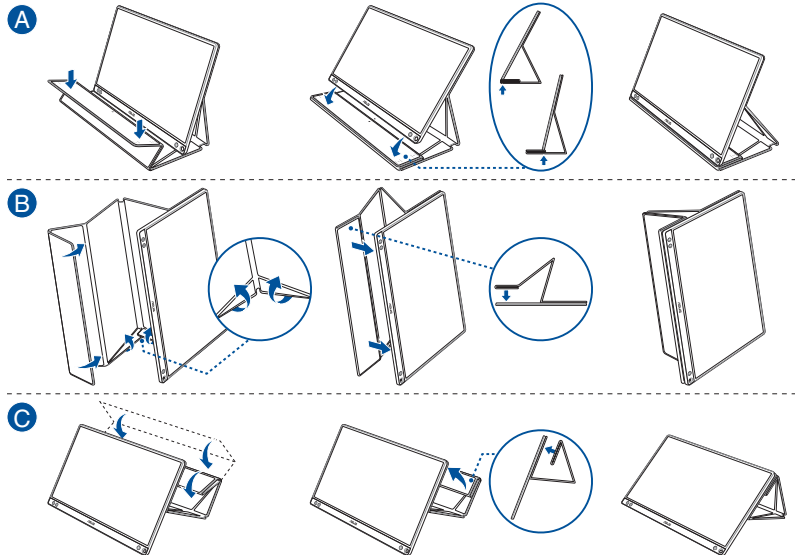

MB16ACE:

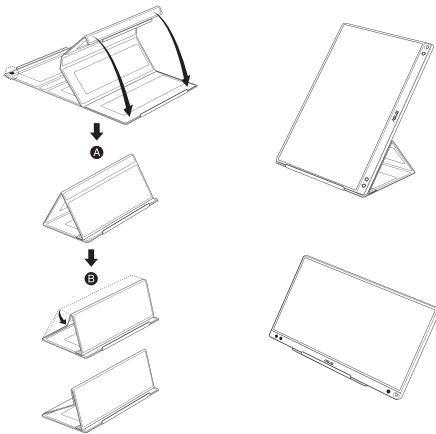

2.2 Connect the USB monitor with system

A

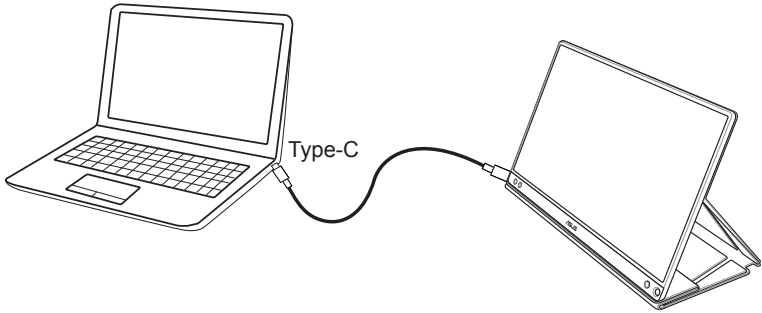

or

B

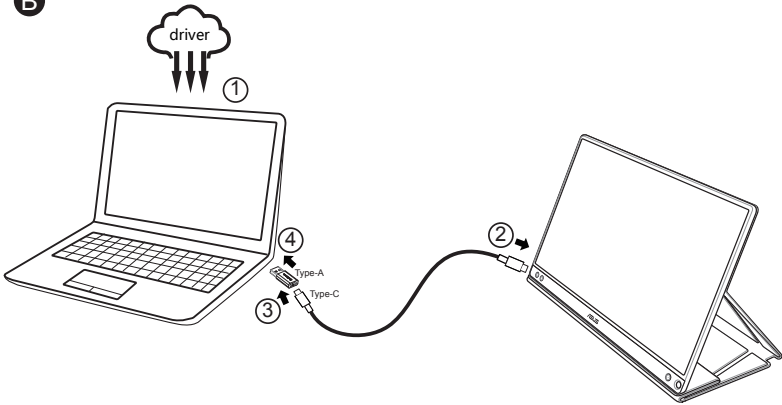

In case the computer does not support Type-C interface but only USB3.0 interface, please install the official driver from ASUS website firstly.

Please make sure the USB Type-C cable and Type-C to A adapter is connected between the USB monitor and the system.



- Please check ASUS website for latest driver and DisplayWidget software.

2.3 Announcements

As this product and attached smart cover includes magnet in the structure, there could be potential risk to cause the damage of computer hard disc and objects that are sensitive to magnet.

Please ensure not to stack the product with the computer when computer is in use (power on or standby mode) otherwise the hard drive could possibly be influenced by the result of permanent data missing or the computer display could be switched off due to computer auto protection mechanism. When place this product together with computer in the bag, must have the computer power off to avoid possible hard drive damage problem.

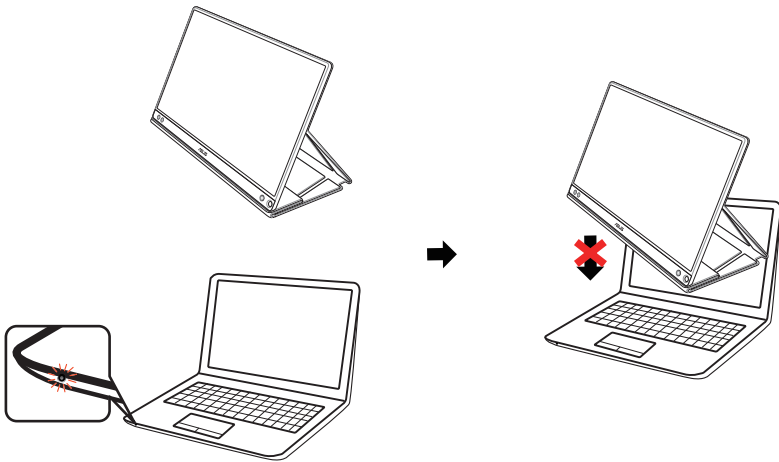

3.1 OSD (On-Screen Display) menu

3.1.1 How to reconfigure

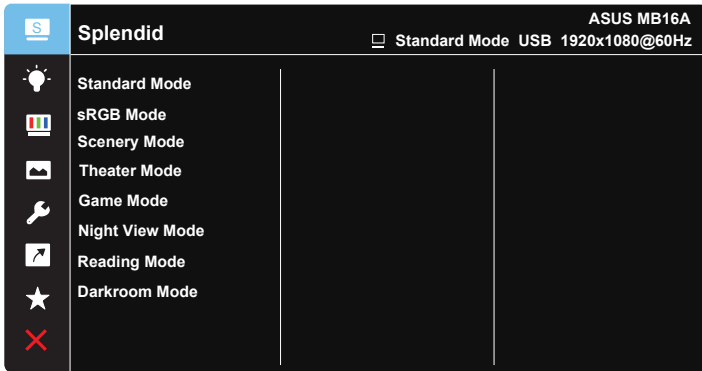

1. Press the MENU button to activate the OSD menu.
2. Press the ▼ button to toggle between options in the Menu. As you move from one icon to another, the option name is highlighted.
3. To select the highlighted item on the menu press the ✓ button.
4. Press the ▼ button to select the desired parameter.
5. Press the ✓ button to enter the slide bar and then use the ▼ button, according to the indicators on the menu, to make your changes.
6. Select the ↶ to return to previous menu or ✓ to accept and return to previous menu.

3.1.2 OSD Function Introduction

1. Splendid

This function contains eight sub-functions that you can select for your preference.

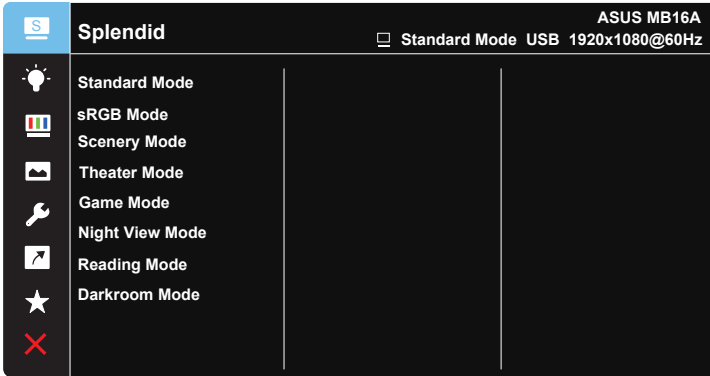

- **Standard Mode:** This is the best choice for document editing with SILENDID™ Video Intelligence Technology.
- **sRGB Mode:** This is the best choice for viewing photos and graphics from PCs.
- **Scenery Mode:** This is the best choice for scenery photo displaying with SILENDID™ Video Intelligence Technology.
- **Theater Mode:** This is the best choice for movie watching with SILENDID™ Video Intelligence Technology.
- **Game Mode:** This is the best choice for game playing with SILENDID™ Video Intelligence Technology.
- **Night View Mode:** This is the best choice for playing dark-scene game or watching dark-scene movie with SILENDID™ Video Intelligence Technology.
- **Reading Mode :** This is the best choice for book reading.
- **Darkroom Mode :** This is the best choice for a weak ambient light environmen.



-
- In the Standard Mode, the Saturation, SkinTone, Sharpness, and ASCR functions are not user-configurable.
 - In the sRGB, the Saturation, Color Temp., SkinTone, Sharpness, Brightness, Contrast and ASCR functions are not user-configurable.
 - In the Reading Mode, the Saturation, SkinTone, Sharpness, ASCR, contrast, and Color Temp functions are not user-configurable.
-

2. Blue Light Filter

Adjust the energy level of blue light emitted from LED backlight.

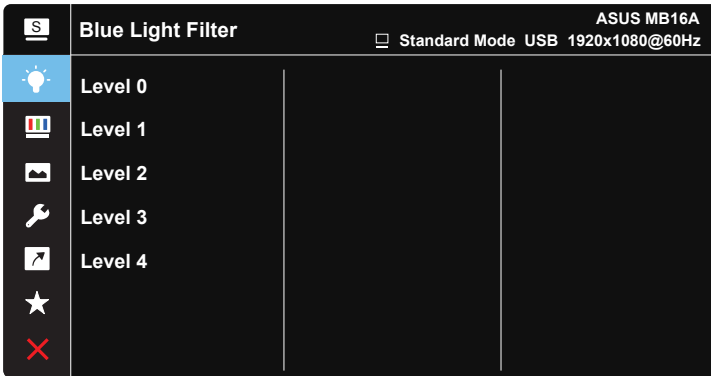

- **Level 0:** No change.
- **Level 1~4:** The higher the level, the more blue light will be reduced.



- When Blue Light Filter is activated, the default settings of Standard Mode will be automatically imported.
- Between Level 1 to Level 3, the Brightness function is user-configurable.
- Level 4 is optimized setting. It is compliance with TUV Low Blue Light Certification. The Brightness function is not user-configurable.



Please refer to the following to alleviate eye strains:

- Users should take some time away from the display if working for long hours. It is advised to take short breaks (at least 5 mins) after around 1 hour of continuous working at the computer. Taking short and frequent breaks is more effective than a single longer break.
- To minimize eye strain and dryness in your eyes, users should rest the eye periodically by focusing on objects that are far away.
- Eye exercises can help to reduce eye strain. Repeat these exercises often. If eye strain continues please consult a physician. Eye exercises: (1) Repeating look up and down (2) Slowly roll your eyes (3) Move your eyes diagonal.
- High energy blue light may lead to eye strain and AMD (Age-Related Macular Degeneration). Blue light Filter to reduce 70% (max.) harmful blue light to avoiding CVS (Computer Vision Syndrome).

3. Color

Select the image color you like from this function.

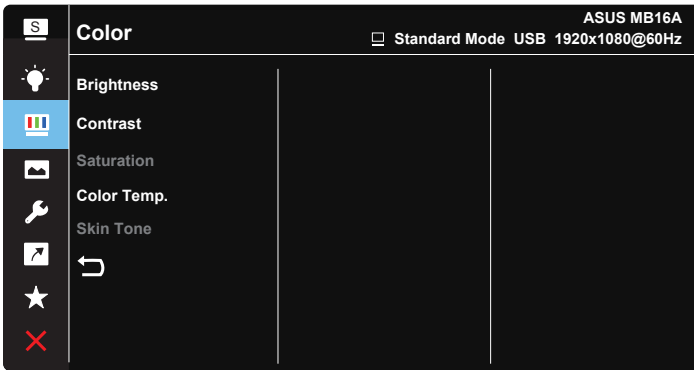

- **Brightness:** The adjusting range is from 0 to 100.
- **Contrast:** The adjusting range is from 0 to 100.
- **Saturation:** The adjusting range is from 0 to 100.
- **Color Temp.:** Contains three preset color modes (**Cool**, **Normal**, **Warm**) and **User Mode**.
- **Skin Tone:** Contains three color modes including **Reddish**, **Natural**, and **Yellowish**.



-
- In the User Mode, colors of R (Red), G (Green), and B (Blue) are user-configurable; the adjusting range is from 0 ~ 100.
-

4. Image

You can adjust the image Sharpness, Trace Free, Aspect Control, VividPixel and ASCR from this main function.

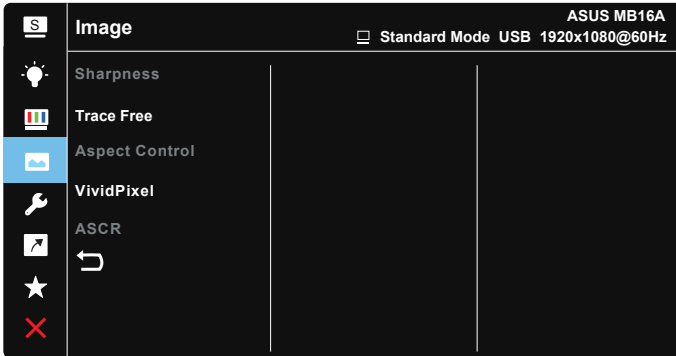

- **Sharpness:** Adjusts the picture sharpness. The adjusting range is from 0 to 100.
- **Trace Free:** Speeds up the response time by Over Drive technology. The adjusting range is from lower 0 to faster 100.
- **Aspect Control:** Adjusts the aspect ratio to “Full”, “4:3”, “1:1”.
- **VividPixel:** ASUS Exclusive Technology that brings lifelike visuals for crystal-clear and detail-oriented enjoyment. The adjusting range is from 0 to 100.
- **ASCR:** Select **ON** or **OFF** to enable or disable dynamic contrast ratio function.



-
- 4:3 is only available when input source is in 4:3 format.
-

5. System Setup

Adjusts the system configuration.

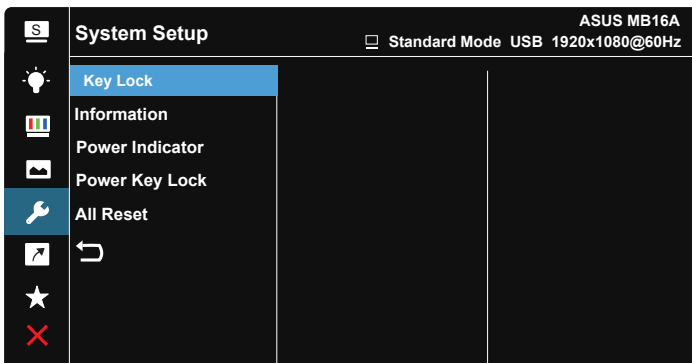
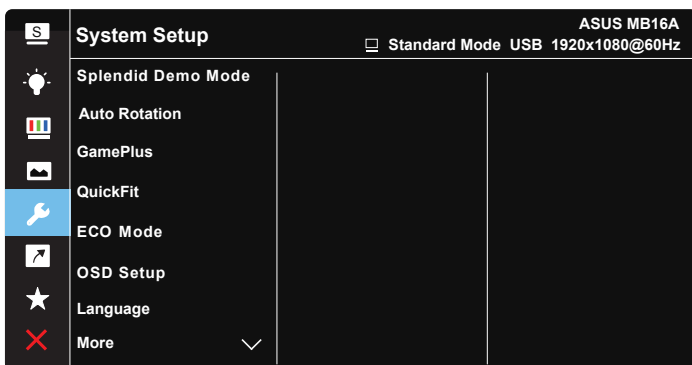

- **Splendid Demo Mode:** Activate the demo mode for the Splendid function.
- **Auto Rotation:** To enable/disable rotate image automatically. Please be noted that Auto rotation function is only working under **Windows OS** by installing DisplayWidget software
- **GamePlus:** The GamePlus Function provides a toolkit and creates a better gaming environment for users when playing different types of games. Particularly, Chrosshair function is specially designed for new gamers or beginners interested in First Person Shooter (FPS) games. To active GamePlus:
 - Select **ON** to enter the GamePlus main menu.

- Press **▶** to select between Crosshair, Timer and Display Alignment function.
- Press **✓** to confirm the function you choose. Select **✕** to go off, and exit.

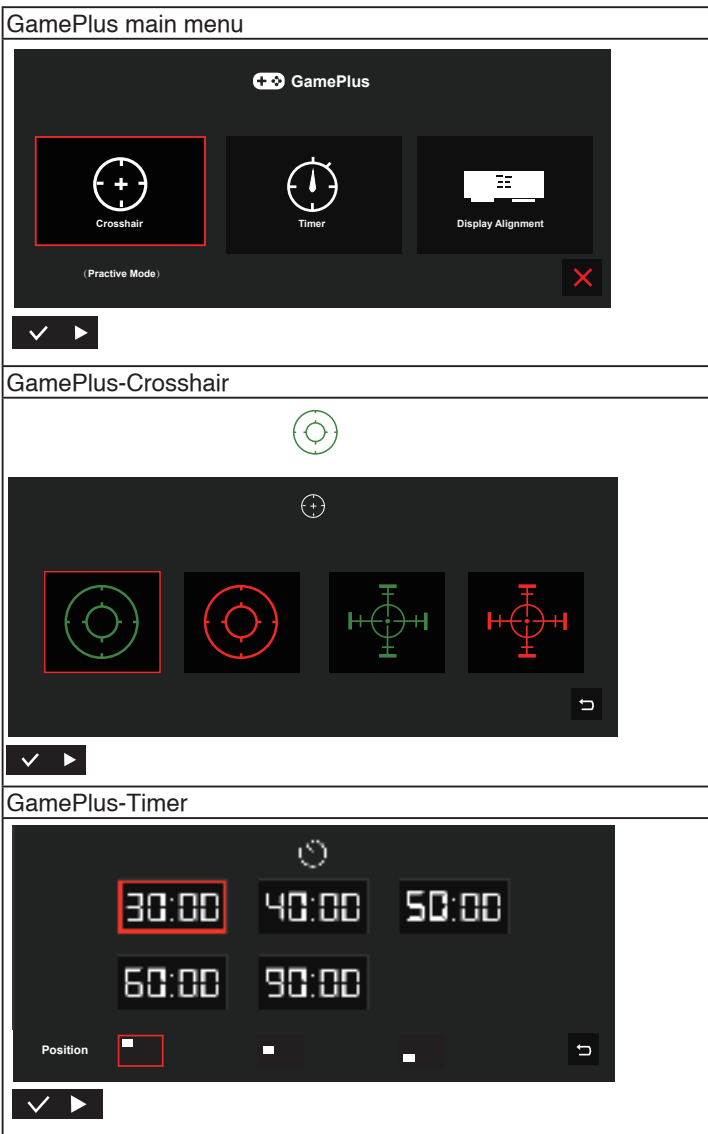

- **QuickFit:** See page 1-3 for details.
- **ECO Mode:** Activate the ecology mode for power saving.
- **OSD Setup:** Adjusts the **OSD Timeout**, **DDC/CI**, and **Transparency** of the OSD screen.
- **Language:** Select OSD language. The selections are: **English, French, German, Spanish, Italian, Dutch, Russian, Poland, Czech, Croatia, Hungary, Romania, Portugal, Turkey, Simplified Chinese, Traditional Chinese, Japanese, Korean, Persian, Thai** and **Indonesian**.
- **More:** Return the next page of System Setting.
- **Key Lock:** Disable all key functions. Pressing the menu button for more than five seconds to disable key lock function.
- **Information:** Displays the monitor information.
- **Power Indicator:** Turn the power LED indicator on/off.
- **Power Key Lock:** To disable / enable power key.
- **All Reset:** Selects "**Yes**" to revert all settings to the factory default mode.

6. Shortcut

Selecting this option allows you to set shortcut key.

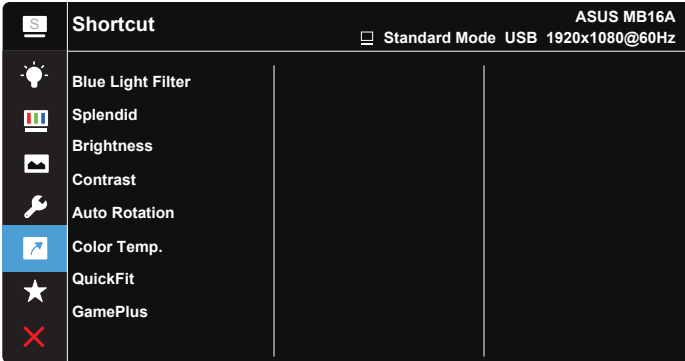

- **Shortcut** : User can select from “Blue Light Filter” “Splendid”, “Brightness”, “Contrast”, “Auto Rotation”, “Color Temp.”, “QuickFit”, “GamePlus” and set as shortcut key.

7. MyFavorite

Load/Save all settings on the monitor.

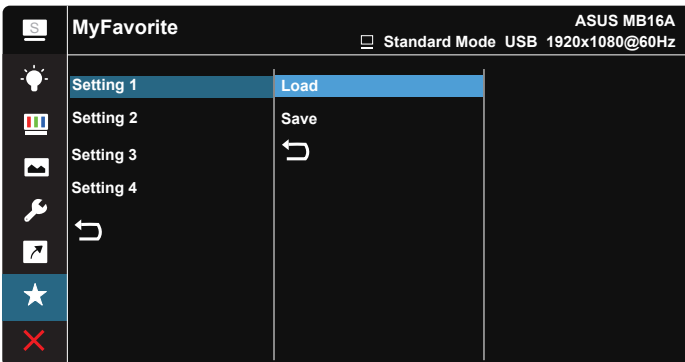

3.2 Specifications

Model	MB16AC/MB16ACR/MB16ACM/ MB16ACE
Panel Size	15.6" (16:9, 39.62cm) wide screen
Resolution	1920 x 1080
Brightness (Typ.)	220 cd/m ²
Contrast (Typ.)	800:1
Display Colors	262 K
Digital Input	DisplayPort™ Alt Mode for USB Type-C™
Colors	Dark Gray
Power Consumption	≤ 8 W
Operating Temp.	0° ~ 40°
Phys. Dimension (WxHxD)	359.7 x 226.4 x 8.0 mm
Box Dimension (WxHxD)	434 x 310 x 76 mm 434 x 290 x 76 mm (MB16ACE)
Net Weight (Esti.)	0.78 kg 0.71 kg (MB16ACE)
Gross Weight (Esti.)	3.0 kg 1.65 kg (MB16ACE)
Regulation Approvals	UL/cUL, CB, CE, CCC, KCC, FCC, BSMI, EAC(CU), RCM, VCCI, J-Moss, UkrSEPRO, RoHS, WEEE, Windows 7 & 8.1 & 10 WHQL, Blue light filter, Flicker free, Energy Star 7.0
Voltage Rating	4.75-5.25V ---, 1.5A

*Specifications are subject to change without notice.

3.3 Troubleshooting (FAQ)

Problem	Possible Solution
Power LED is not ON	<ul style="list-style-type: none">• Press the  button to check if the monitor is in the ON mode.• Check if the USB Type-C cable is properly connected to the monitor and the computer.
The power LED lights amber and there is no screen image	<ul style="list-style-type: none">• Check if the monitor and the computer are in the ON mode.• Make sure the USB Type-C cable is properly connected between the Portable USB Monitor and the computer.• Inspect the signal cable and make sure none of the pins are bent.• Connect the computer with another available monitor to check if the computer is properly working.
Screen image is too light or dark	<ul style="list-style-type: none">• Adjust the Brightness settings via the button.
Screen image bounces or a wave pattern is present in the image	<ul style="list-style-type: none">• Make sure the USB Type-C cable is properly connected between the Portable USB Monitor and the computer.• Move electrical devices that may cause electrical interference.
Screen image has color defects (white does not look white)	<ul style="list-style-type: none">• Inspect the USB Type-C cable and make sure that none of the pins are bent.

Problem	Possible Solution
<p>After connecting with the USB Type-C source device, the power LED lights continuously blinking or showing ASUS logo repeatedly</p>	<ul style="list-style-type: none"> • Insufficient power supply from source USB Type-C devices. Please follow below steps: • Press the Blue Light Filter button , and then connect the USB Type-C cable. This operation will enable built-in safe mode. After displaying ASUS logo, please release the Blue Light Filter button. After ASUS Logo disappearing, there is “safe mode” message OSD showing up. Once “safe mode” message OSD disappears, please set background color to white image or nearly white image (*1). • Press MENU button, main menu OSD is showing. The upper left corner of the OSD will display small red-colored font “S”, indicating it is now in safe mode. Enter brightness setup, press the up key to tune up brightness. During the process, please note down brightness value “Y” up until MB16AC/MB16ACR/MB16ACM/MB16ACE re-start.(*2). For example, if brightness value shows “70” and MB16AC/MB16ACR/MB16ACM/MB16ACE restarts when adjusting to “71”, “70” is the “Y” value to note down and is the highest brightness value for the connecting USB-C source device. • Press MENU button, main menu OSD is showing. The upper left corner still indicate “S” as safe mode. Adjust the OSD brightness value to “Y” • Close the OSD and press Low Blue Low Filter hot key for 5 seconds to turn off safe mode. • Complete.

*1: White color background will consume higher power, so it's better to use white color background to test the power limit from source USB Type-C device.

*2: If MB16AC/MB16ACR/MB16ACM/MB16ACE does not re-start when adjusting to value 100, that means source USB Type-C device has sufficient power supply.

3.4 Supported Timing List

PC Supported Primary Timing

Resolution	Refresh Rate	Horizontal Frequency
640x480	60Hz	31.469kHz
800x600	60Hz	37.879kHz
1024x768	60Hz	48.363kHz
1280x960	60Hz	60kHz
1280x1024	60Hz	63.981kHz
1440x900	60Hz	55.935kHz
1680x1050	60Hz	65.29kHz
1920x1080	60Hz	67.5kHz

IBM Modes, Factory Preset Timing

Resolution	Refresh Rate	Horizontal Frequency
640x350	70Hz	31.469kHz
720x400	70Hz	31.469kHz

VESA Modes, User Available Timing

Resolution	Refresh Rate	Horizontal Frequency
848x480	60Hz	31.02kHz
1280x720	60Hz	44.772kHz
1280x800	60Hz	49.702kHz
1920x1080	60Hz	66.587kHz