

ECAM45.760

BEAN TO CUP ESPRESSO
AND CAPPUCCINO
MACHINE
Instruction for use

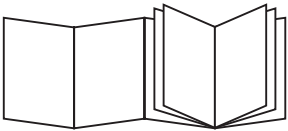

DeLonghi



B

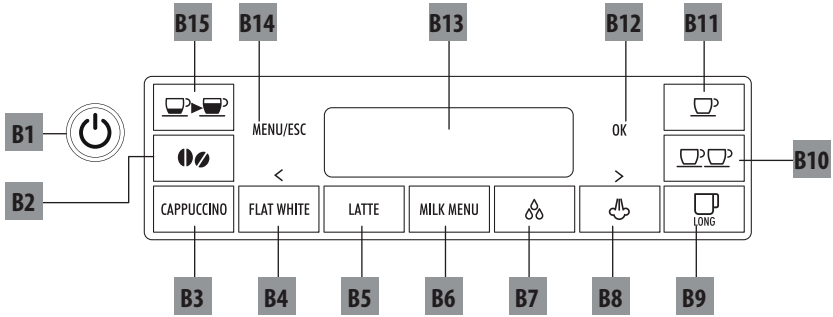

C

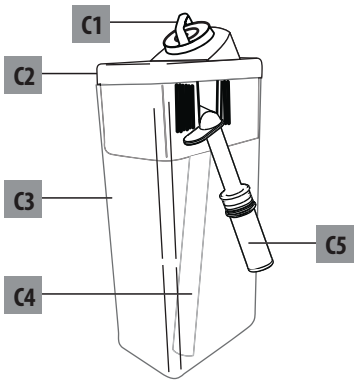

D

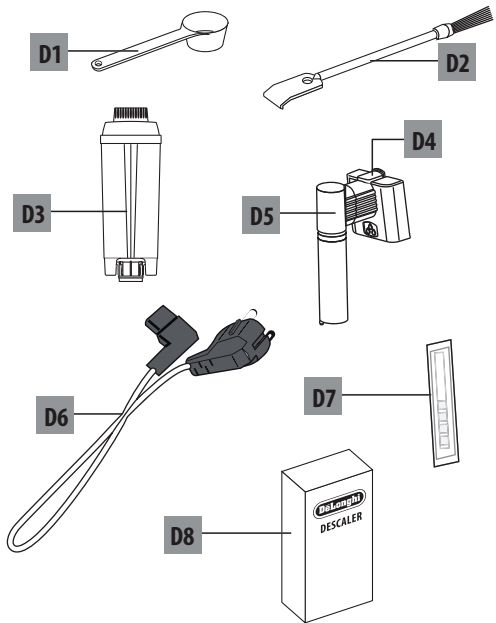

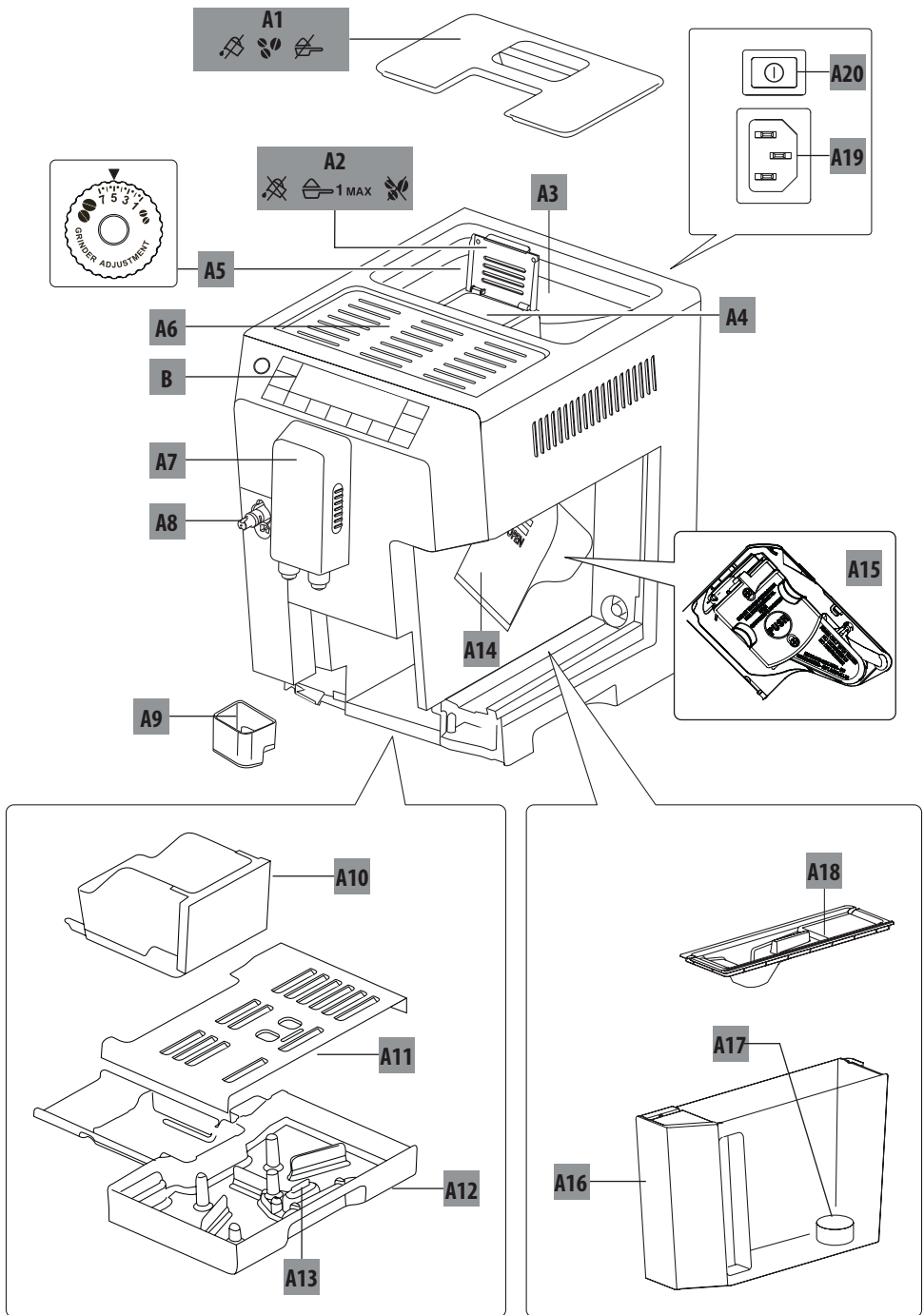

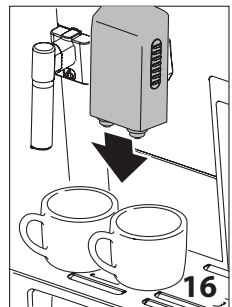
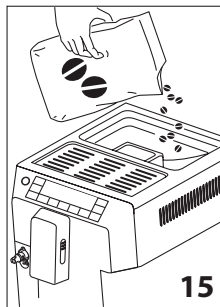
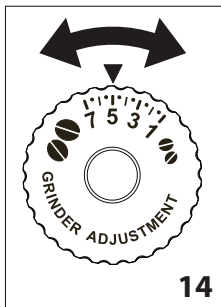
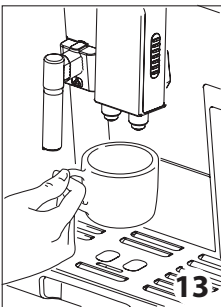
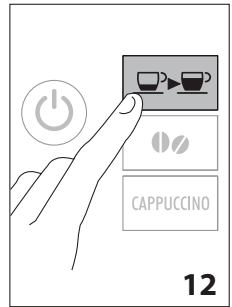
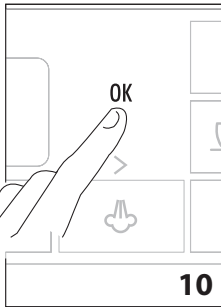
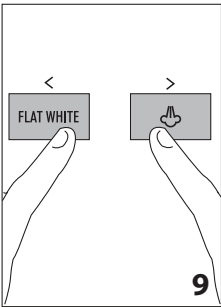
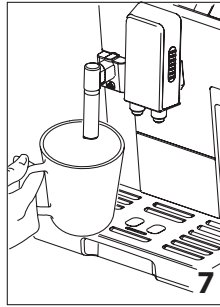
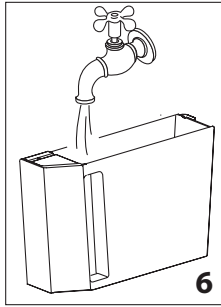
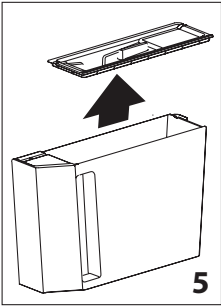
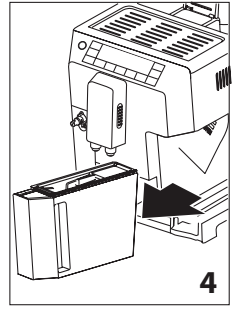
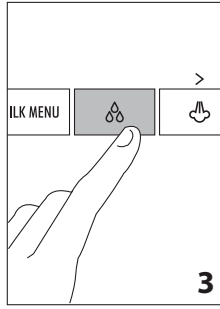
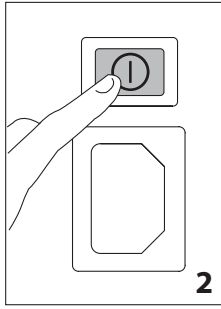
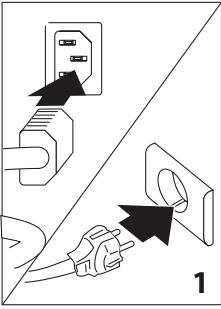

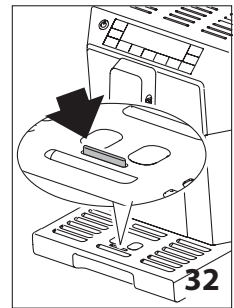
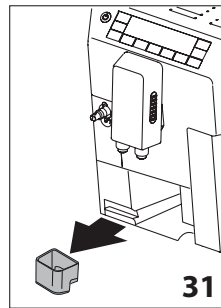
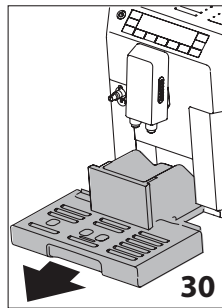
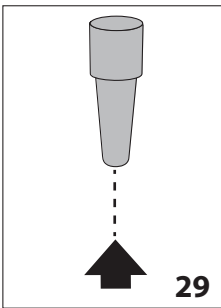
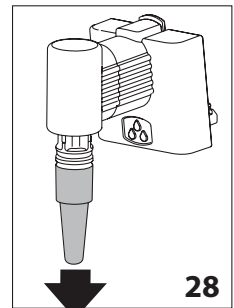
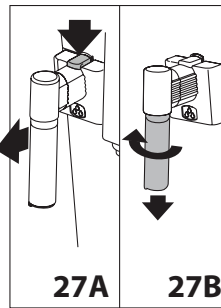
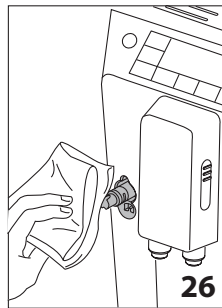
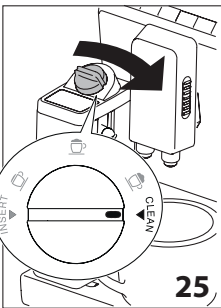
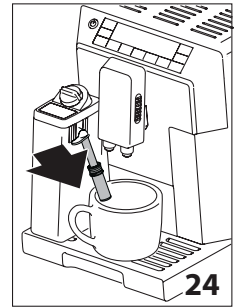
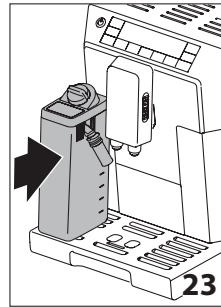
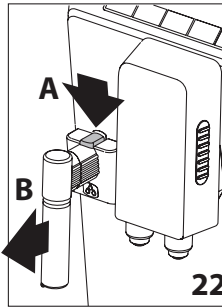
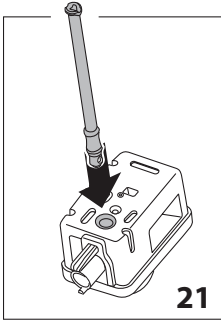
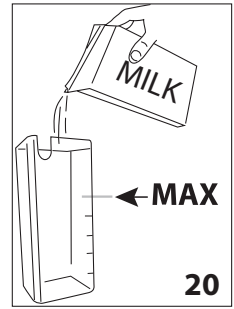
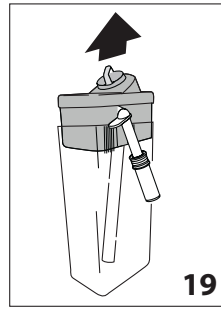
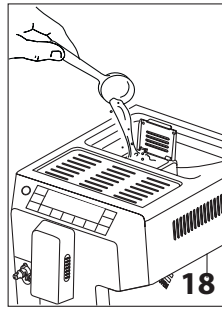
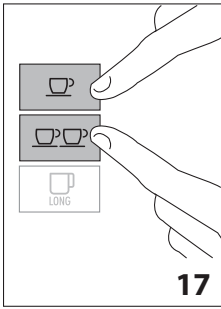

CONTENTS

INTRODUCTION	7
Symbols used in these instructions	7
Letters in brackets	7
Troubleshooting and repairs	7
SAFETY	7
Fundamental safety warnings.....	7
Designated use	7
Instruction for Use.....	8
DESCRIPTION	8
Description of the appliance	8
Description of the milk container.....	8
Description of the accessories	8
BEFORE USE	8
Checking the appliance	8
Setting up the appliance	9
Prima messa in funzione dell'apparecchio	9
TURNING THE APPLIANCE ON	9
TURNING THE APPLIANCE OFF	9
MENU SETTINGS	10
Rinsing.....	10
Descaling	10
Install filter	10
Replacing the filter (if installed)	10
Adjust time	10
Auto-start	10
Auto-Off (standby).....	10
Cup warmer	10
Energy saving.....	11
Setting the temperature	11
Setting water hardness	11
Setting the language	11
Beep	11
Default values (reset).....	11
Statistics function	11
MAKING COFFEE	12
Selecting the coffee taste.....	12
Selecting the quantity of coffee in the cup	12
Customising the "my coffee" quantity	12
Adjusting the coffee mill	12
Tips for a hotter coffee	12
Making coffee using coffee beans	12
Making coffee using pre-ground coffee	13
Preparazione del caffè LONG	13
Personalizzazione della quantità di "mio caffè LONG".....	13

MAKING CAPPUCCINOS AND MILK BASED

COFFEES	13
Filling and attaching the milk container	13
Adjusting the amount of froth	14
Making milk based coffees automatically	14
Making hot drinks using the "MILK MENU"	14
Cleaning the milk container after use	14
Programming the quantity of coffee and milk in the cup for the CAPPUCCINO, FLAT WHITE and LATTE buttons	14
Programming the quantity of coffee and milk in the cup for the MILK MENU button drinks.....	15

DELIVERING HOT WATER AND STEAM	15
Delivering hot water	15
Changing the quantity of water delivered automatically.....	15
Delivering steam.....	15
Tips for using steam to froth milk.....	15
Cleaning the spout after use	15

CLEANING	16
Cleaning the coffee grounds container.....	16
Cleaning the inside of the coffee machine	16
Cleaning the water tank.....	16
Cleaning the coffee spouts.....	16
Cleaning the pre-ground coffee funnel	17
Cleaning the infuser	17
Cleaning the milk container	17
Cleaning the hot water/steam connection nozzle	18

DESCALING	18
SETTING WATER HARDNESS	18
Measuring water hardness.....	19
Setting water hardness	19

WATER SOFTENER FILTER	19
Installing the filter	19
Replacing the filter	20
Removing the filter	20

TECHNICAL DATA	20
-----------------------------	-----------

DISPLAYED MESSAGES	21
---------------------------------	-----------

TROUBLESHOOTING	22
------------------------------	-----------

INTRODUCTION

Thank you for choosing this automatic espresso and cappuccino machine.

We hope you enjoy using your new appliance.

Take a few minutes to read this Instruction for Use.

This will avoid all risks and damage to the appliance.

Symbols used in these instructions

Important warnings are identified by these symbols. It is vital to respect these warnings.



Failure to observe the warning may result in life threatening injury by electric shock.



Failure to observe the warning could result in injury or damage to the appliance.



Failure to observe the warning could result in burns or scalding.



This symbol identifies important advice or information for the user.

Letters in brackets

The letters in brackets refer to the legend in the Description of the Appliance on pages 2 and 3.

Troubleshooting and repairs

In the event of problems, first try and resolve them following the information given in the sections "Displayed messages" on page 21 and "Troubleshooting" on page 22.

If this does not resolve the problem or you require further information, you should consult Customer Services by calling the number given on the annexed "Customer Service" sheet.

If your country is not among those listed on the sheet, call the number given in the guarantee. If repairs are required, contact De'Longhi Customer Services only. The addresses are given in the guarantee certificate provided with the machine.

SAFETY

Fundamental safety warnings



This is an electrical appliance and may cause electric shock.

You should therefore follow these safety warnings:

- Never touch the appliance with damp hands or feet.
- Never touch the plug with damp hands.
- Make sure the socket used is freely accessible at all times, enabling the appliance to be unplugged when necessary.

- Unplug directly from the plug only. Never pull the power cable as you could damage it.
- To disconnect the appliance completely, unplug it from the mains socket.
- If the appliance is faulty, do not attempt to repair. Turn it off, unplug from the mains socket and contact Customer Services.

If the plug or power cable is damaged, it must be replaced by De'Longhi Customer Services only to avoid all risk.

Never immerse the appliance in water when cleaning. It is an electrical appliance.

- Before cleaning the outside of the appliance, turn it off, unplug from the mains socket and allow to cool.



Keep all packaging (plastic bags, polystyrene foam) away from children.

This appliance can be used by children aged from 8 years and above and persons with reduced physical, sensory or mental capabilities or lack of experience and knowledge if they

have been given supervision or instruction concerning use of the appliance in a safe way and understand the hazards involved.

Children shall not play with the appliance.

Cleaning and user maintenance shall not be made by children without supervision.



This appliance produces hot water and steam may form while it is in operation.

Avoid contact with splashes of water or hot steam.

When the appliance is in operation, do not touch the cup warmer shelf, as it is hot.



Surfaces marked with this symbol become hot during use (the symbol is present on certain models only).

Designated use

This appliance is designed and made to prepare coffee and heat drinks.

This is a household appliance only.

It is not intended to be used in:

- staff kitchen areas in shops, offices and other working environments;
- farm houses;
- by clients in hotels, motels and other residential type environments;
- bed and breakfast type environments.

Any other use is considered improper and thus dangerous.

The manufacturer is not liable for damage deriving from improper use of the appliance.

Instruction for Use

Read these instructions carefully before using the appliance. Failure to respect these instructions may result in burns or damage to the appliance.

The manufacturer is not liable for damage deriving from failure to respect this Instruction for Use.



Please note:

Keep this Instruction for Use.

If the appliance is passed to other persons, they must also be provided with this Instruction for Use.

DESCRIPTION

Description of the appliance

(page 3 - A)

- A1. Beans container lid
- A2. Pre-ground coffee funnel lid
- A3. Beans container
- A4. Pre-ground coffee funnel
- A5. Grinding adjustment dial
- A6. Cup warmer shelf
- A7. Coffee spout (adjustable height)
- A8. Hot water and steam connection nozzle
- A9. Condensate tray
- A10. Coffee grounds container
- A11. Cup tray
- A12. Drip tray
- A13. Drip tray water level indicator
- A14. Infuser door
- A15. Infuser
- A16. Water tank
- A17. Water softener filter housing
- A18. Water tank lid
- A19. Power cable socket
- A20. Main switch

Description of the control panel

(page 2 - B)

A number of buttons on the panel have a double function. This is indicated in brackets in the description.

- B1. button: turns the appliance on and off (standby)
- B2. aroma selection button: press to select coffee taste
- B3. **CAPPUCCINO** button: to make a cappuccino
- B4. **FLAT WHITE** button: to make a flat white (*in the settings menu, press this button to scroll the menu items*)
- B5. **LATTE** button: to make a latte
- B6. **MILK MENU** button: to access the functions for preparing MILK, CAFFELATTE, ESPRESSO MACCHIATO and MY MILK
- B7. button: to deliver hot water
- B8. button: to deliver steam (*in the settings menu, press this button to scroll the menu items*)
- B9. button: to make 1 cup of LONG coffee
- B10. button: to make 2 cups of coffee with the settings displayed
- B11. button: to make 1 cup of coffee with the settings displayed
- B12. **OK** button: to enable and confirm the selected function
- B13. Display: guides the user in using the appliance
- B14. **MENU/ESC** button to access the menu (*in the settings menu: press to exit the menu*)
- B15. button: to select the quantity of coffee

Description of the milk container

(page 2 - C)

- C1. Froth adjustment and CLEAN dial
- C2. Milk container lid
- C3. Milk container
- C4. Milk intake tube
- C5. Frothed milk spout (adjustable)

Description of the accessories

(page 2 - D)

- D1. Pre-ground coffee measure
- D2. Cleaning brush
- D3. Water softener filter (certain models only)
- D4. Button to release the cappuccino maker/hot water spout
- D5. Cappuccino maker/hot water spout
- D6. Power cable
- D7. "Total Hardness Test" indicator strip
- D8. Descaler

BEFORE USE

Checking the appliance

After removing the packaging, make sure the product is complete and undamaged and that all accessories are present. Do not use the appliance if it is visibly damaged. Contact De'Longhi Customer Services.

Installing the appliance



Important!

When you install the appliance, you should respect the following safety warnings:

- The appliance gives off heat. After positioning the appliance on the worktop, leave a space of at least 3 cm between the surfaces of the appliance and the side and rear walls and at least 15 cm above the coffee machine.
- Water penetrating the appliance could cause damage. Do not place the appliance near taps or sinks.
- The appliance could be damaged if the water it contains freezes. Do not install the appliance in a room where the temperature could drop below freezing point.
- Arrange the power cable in such a way that it cannot be damaged by sharp edges or contact with hot surfaces (e.g. electric hot plates).

Setting up the appliance



Important!

Check that the mains power supply voltage corresponds to the value indicated on the rating plate on the bottom of the appliance.

Connect the appliance to an efficiently earthed and correctly installed socket with a minimum current rating of 10A only.

If the power socket does not match the plug on the appliance, have the socket replaced with a suitable type by a qualified professional.

Using the appliance for the first time



Please note!

- Coffee has been used to factory test the appliance and it is therefore completely normal for there to be traces of coffee in the mill. The machine is, however, guaranteed to be new.
 - You should customise water hardness as soon as possible following the Instruction for use in the section "Setting water hardness (page 19).
1. Plug the power cable into the socket on the back of the appliance and connect the appliance to the mains power supply (fig. 1) and make sure that the main switch, located on the side of the appliance, is pressed (fig. 2).

Select the desired language by scrolling forwards or backwards using the **FLAT WHITE** or  button, or alternatively waiting for the language options to scroll automatically on the display (about every 3 seconds):

2. When "English" appears, hold the  button (fig. 3) for a few seconds until "English set" is displayed.

Follow the instructions indicated on the appliance display:

3. "FILL TANK": extract the water tank (fig. 4), open the lid (fig. 5), fill to the MAX line with fresh water (fig. 6); close the lid again and then replace the tank.
4. INSERT WATER SPOUT: Check that the hot water spout is inserted on the connection nozzle and place a container holding a minimum of 100 ml underneath (fig. 7).
5. "Insert Water Spout and Press Ok" is displayed;
6. Press the  button to confirm (fig. 3). The appliance delivers water from the spout then goes off automatically.

The coffee machine is now ready for normal use.



Please note!

- When using the appliance for the first time, you need to make 4-5 cups of coffee or 4-5 cappuccinos before it starts to give satisfactory results.
- When making the first 5-6 cappuccinos, it is normal to hear the noise of boiling water. After this, the noise becomes less.
- To enjoy your coffee even more and improve the performance of your appliance, we recommend installing a water softener filter as described in the section "WATER SOFTENER FILTER" (page 19). If your model is not provided with a filter, you can request one from De'Longhi Customer Services.

TURNING THE APPLIANCE ON



Please note!

Before turning the appliance on, make sure the main switch is pressed (fig. 2).

Each time the appliance is turned on, it performs an automatic preheat and rinse cycle which cannot be interrupted.

The appliance is ready for use only after completion of this cycle.



Danger of burns!

During rinsing, a little hot water comes out of the coffee spouts and is collected in the drip tray underneath.

Avoid contact with splashes of water.

- To turn the appliance on, press the  button (fig. 8). The message "Heating up, Please wait" is displayed. After heating, the message "Rinsing" is displayed. As well as heating the boiler, the appliance also heats the internal circuits by circulating hot water. The appliance is at temperature when the message indicating the taste and quantity of coffee appears.

TURNING THE APPLIANCE OFF

Whenever the coffee machine is turned off after being used to make coffee, it performs an automatic rinse cycle.

Danger of burns!

During rinsing, a little hot water flows from the coffee spouts. Avoid contact with splashes of water.

- To turn the appliance off, press the  button (fig. 8).
- The message "Turning off, Please wait" is displayed: if featured, the appliance completes a rinse cycle and then goes off (standby).

Please note!

If you will not be using the appliance for some time, unplug from the mains socket:

- first turn the appliance off by pressing the  button (fig. 8);
- release the main switch at the back of the appliance (fig. 2).

Important!

Never press the main switch while the appliance is on.

MENU SETTINGS

When you access the settings menu by pressing the **MENU/ESC** button, scroll the menu items by pressing < or > (fig. 9).

Rinsing

Use this function to deliver hot water from the spout to heat the internal circuit and make the coffee delivered hotter.

To enable the function, proceed as follows:

1. Press the **MENU/ESC** button to enter the menu;
2. Press < or > (fig. 9) until "Rinsing" is displayed;
3. Press the **OK** button: "Confirm?" will be displayed.
4. Press the **OK** button (fig. 10): after a few seconds, hot water flows out of the spout, heating the internal circuit and making the coffee delivered hotter.

Please note!

Press any button to stop hot water delivery at any time.

Descaling

For instructions on descaling, see page 18.

Install filter

For instructions on how to install the filter, see the section "Water softener filter" (page 19).

Replacing the filter (if installed)

For instructions on how to replace the filter, see the section "Replacing the filter" (page 20).

Adjust time

To adjust the time on the display, proceed as follows:

1. Press the **MENU/ESC** button to enter the menu;
 2. Press < or > (fig. 9) until "Adjust time" is displayed;
 3. Press the **OK** button (fig. 10): the hours flash;
 4. Press < or > (fig. 9) to change the hours;
 5. Press the **OK** button to confirm: the minutes flash;
 6. Press < or > (fig. 9) to change the minutes;
 7. Press the **OK** button to confirm.
- This sets the time. Press the **MENU/ESC** button to exit the menu.

Auto-start

You can set the auto-start time in order to have the appliance ready at a certain time (for example in the morning) so you can make coffee immediately.

Please note!

To enable this function, the time must already be set correctly.

To enable auto-start, proceed as follows:

1. Press the **MENU/ESC** button to enter the menu;
2. Press < or > (fig. 9) until "Auto-start" is displayed;
3. Press the **OK** button. "Enable?" is displayed;
4. Press the **OK** button to confirm;
5. Press < or > to choose the hours;
6. Press the **OK** button to confirm;
7. Press < or > (fig. 9) to change the minutes;
8. Press the **OK** button to confirm;
9. Then press the **MENU/ESC** button to exit the menu.

Once the time has been confirmed, activation of auto-start is indicated by the  symbol displayed alongside the time.

To disable the function:

1. Select auto-start from the menu;
2. Press the **OK** button. "Disable?" is displayed;
3. Press the **OK** button to confirm.

The  symbol is no longer displayed.

Auto-Off (standby)

Auto-off mode can be set, so that the appliance switches off when not used for 15 or 30 minutes, or 1, 2 or 3 hours.

To programme Auto-off, proceed as follows:

1. Press the **MENU/ESC** button to enter the menu;
2. Press < or > (fig. 9) until "Auto-off" is displayed;
3. Press the **OK** button;
4. Press < or > (fig. 9) until the required operating time (15 or 30 minutes, or 1, 2 or 3 hours) is displayed;
5. Press the **OK** button to confirm;
6. Then press the **MENU/ESC** button to exit the menu.

Auto-off is programmed.

Cup warmer

This function allows the cup warmer to be enabled or disabled.

Proceed as follows:

1. Press the **MENU/ESC** button to enter the menu;
 2. Press < or > (fig. 9) until "Cup warmer" is displayed;
 3. Press the **OK** button: "Enable?" or "Disable?" will be displayed
 4. Press the **OK** button to enable or disable the cup warmer ("Cup warmer" "Enabled" on the display indicates the function is enabled)
 5. Press the **MENU/ESC** button to exit the menu.
- Warming the cups keeps the coffee hot.

Energy saving

Use this function to enable or disable energy saving.

When enabled, the function reduces energy consumption in compliance with European regulations.

To disable (or enable) energy saving, proceed as follows:

1. Press the **MENU/ESC** button to enter the menu;
2. Press < or > (fig. 9) until "Energy saving" is displayed;
3. Press the **OK** button. "Disable?" is displayed (or "Enable?" if the function has been disabled);
4. Press the **OK** button to disable (or enable) energy saving mode;
5. Then press the **MENU/ESC** button to exit the menu.

When the function is active, if the machine is not used for some time, "Energy saving" is displayed.



Please note!

- When in energy saving mode, a few seconds elapse before the first coffee, cappuccino or milk based coffee is delivered as the appliance must heat up again.
- To prepare any drink, press any button to exit energy saving, then press the button corresponding to the drink you want to make.
- If the milk container is inserted, "Energy saving" is not activated.

Setting the temperature

To modify the temperature of the water used to make the coffee, proceed as follows:

1. Press the **MENU/ESC** button to enter the menu;
2. Press < or > (fig. 9) until "Set temperature" is displayed;
3. Press the **OK** button;
4. Press < or > until the required temperature (●=low; ●●●●=maximum) is displayed;
5. Press the **OK** button to confirm;
6. Then press the **MENU/ESC** button to exit the menu.

Setting water hardness

For instructions on setting water hardness, see page 20.

Setting the language

To modify the language of the display, proceed as follows:

1. Press the **MENU/ESC** button to enter the menu;
2. Press < or > (fig. 9) until "Set language" is displayed;
3. Press the **OK** button;
4. Press < or > until the required language is displayed;
5. Press the **OK** button to confirm;
6. A message confirming the language installed is displayed;
7. Then press the **MENU/ESC** button to exit the menu.

Beep

This enables or disables the beep emitted by the appliance whenever a button is pressed or an accessory is inserted/removed.

To disable or re-enable the beep, proceed as follows:

1. Press the **MENU/ESC** button to enter the menu;
2. Press < or > (fig. 9) until "Beep" is displayed;
3. Press the **OK** button: "Disable?" is displayed (or "Enable?" if disabled);
4. Press the **OK** button to enable or disable the beep;
5. Press the **MENU/ESC** button to exit the menu.

Default values (reset)

This resets all menu settings and programmed quantities back to the default values (with the exception of the language which remains as set).

To reset the default values, proceed as follows:

1. Press the **MENU/ESC** button to enter the menu;
2. Press < or > (fig. 9) until "Default values" is displayed;
3. Press the **OK** button;
4. "Confirm?" is displayed;
5. Press the **OK** button to confirm and exit.

Statistics function

This displays statistics relating to the machine. To display, proceed as follows:

1. Press the **MENU/ESC** button to enter the menu;
2. Press < or > (fig. 9) until "Statistics" is displayed;
3. Press the **OK** button;
4. Press < or > (fig. 9) to verify:
 - how many coffees have been made;
 - the total number of cappuccinos and milk based coffees made;
 - the total number of litres of water delivered.
 - how many times the machine has been descaled.
 - how many times the water softener filter has been replaced.

- Press the **MENU/ESC** button twice to exit the menu.

MAKING COFFEE

Selecting the coffee taste

The appliance is set by default to make coffee with a standard taste. You can also choose one of these tastes:

- Extra-mild taste
- Mild taste
- Standard taste
- Strong taste
- Extra-strong taste

To change the taste, press the  button (fig. 11) repeatedly until the required taste is displayed.



Selecting the quantity of coffee in the cup

The appliance is set by default to make a standard quantity of coffee. To select the quantity of coffee, press the  button (fig. 12) until the message corresponding to the required quantity of coffee is displayed:

Coffee selected	Quantity in cup (ml)
MY COFFEE	Programmable: from ≈20 to ≈180
SHORT	≈40
STANDARD	≈60
LONG	≈90
EXTRA LONG COFFEE	≈120

Customising the “my coffee” quantity

The appliance is set by default to automatically deliver 30 ml of “MY COFFEE”. To modify this quantity, proceed as follows:

- Place a cup under the coffee spouts (fig. 13).
- Press the  button (fig. 12) until “MY COFFEE” is displayed.
- Keep the  button (fig. 17) pressed until the message “1 MY COFFEE Program quantity” is displayed and coffee delivery begins. Release the button.
- As soon as the coffee in the cup reaches the required level, press the  button (fig. 17) again.

The quantity of coffee in the cup set has now been programmed.

Adjusting the coffee mill

The coffee mill is set by default to prepare coffee correctly and should not require regulating initially.

However, if after making the first few coffees you find that the coffee is either too weak and not creamy enough or delivery is too slow (a drop at a time), this can be corrected by adjusting the grinding adjustment dial (fig. 14).

Please note!

The grinding adjustment dial must only be turned when the coffee mill is in operation.



If the coffee is delivered too slowly or not at all, turn one click clockwise towards “7”.

For fuller bodied creamier coffee, turn one click anticlockwise towards “1” (do not turn more than one click at a time otherwise the coffee could be delivered a drop at a time). These adjustments will only be evident after at least 2 cups of coffee have been delivered. If this adjustment does not obtain the desired result, turn the dial another click.

Tips for a hotter coffee



For hotter coffee, you should:

- perform a rinse cycle, selecting the “Rinsing” function in the settings menu (page 10).
- warm the cups by rinsing them with hot water (using the hot water function);
- increase the coffee temperature in the settings menu (page 11).



Making coffee using coffee beans

Important!

Do not use caramelised or candied coffee beans as they could stick to the coffee mill and make it unusable.

- Fill the container with coffee beans (fig. 15).
- Place under the coffee spouts:
 - 1 cup, if you want to make 1 coffee (fig. 13);
 - 2 cups if you want 2 coffees (fig. 16).
- Lower the spout as near as possible to the cups (fig. 16). This makes a creamier coffee.
- Press the button corresponding to the number of coffees required (1 cup  or 2 cups ).
- Preparation begins. The amount of coffee selected is displayed together with a progress bar which gradually fills as preparation progresses.

Please note:

- While the machine is making coffee, delivery can be interrupted at any moment by pressing any button.
- At the end of delivery, to increase the quantity of coffee in the cup, just press (within 3 seconds) one of the coffee buttons ( or ) (fig. 17).

Once the coffee has been made, the appliance is ready to make the next drink.

i Please note!

- Various alarm messages could be displayed while using the machine (FILL TANK, EMPTY GROUNDS CONTAINER, etc.). Their meaning is explained in the section “Displayed messages” (page 22).
- For hotter coffee, see the section “Tips for a hotter coffee” (page 12).
- If the coffee is delivered a drop at a time, too weak and not creamy enough or too cold, read the tips in the “Troubleshooting” section on (page 22).



Making coffee using pre-ground coffee

! Important!

- Never add pre-ground coffee when the machine is off or it could spread through the inside of the machine and dirty it. This could damage the appliance.
- Never use more than one level measure or it could dirty the inside of the machine or block the funnel.

i Please note!

If you use pre-ground coffee, you can only make one cup of coffee at a time.

1. Press the  button (fig. 11) repeatedly until “Pre-ground” is displayed.
2. Open the lid on the bean container; then open the lid on the pre-ground coffee funnel and lift it up.
3. Make sure the funnel is not blocked, then add one level measure of pre-ground coffee (fig. 18).
4. Place a cup under the coffee spouts.
5. Press the 1 cup button .
6. Preparation begins. The amount of coffee selected is displayed together with a progress bar which gradually fills as preparation progresses.

i Please note!

If “Energy saving” mode is active, you may have to wait a few seconds before the first coffee is delivered.

Making LONG coffee using coffee beans

Prepare the appliance following the same procedure indicated to the paragraph “Making coffee using coffee beans”, then press the LONG  button.

Making LONG coffee using pre-ground coffee

Follow steps 1 to 4 of the paragraph “Making coffee using pre-ground coffee”, then press the LONG  button.



The appliance starts coffee delivery and a progress bar is displayed; halfway, the appliance displays “Insert preground coffee”,

Press OK”. Add one level measure of pre-ground coffee and press OK.

Coffee delivery resumes and the progress bar gradually fills as preparation progresses.

Customising the LONG coffee quantity

The appliance is set by default to automatically deliver 200 ml of “LONG” coffee. To modify this quantity, proceed as follows:

1. Place a sufficiently large cup or a glass under the coffee spouts (fig. 9).
2. Keep the LONG  button pressed (fig.17) until “Program quantity” is displayed.
3. Release the LONG  button: coffee delivery begins,;
4. As soon as the coffee in the cup reaches the required level, press the LONG  button (fig. 17) again.

The quantity of LONG coffee in the cup set has now been programmed.

i Please note!

If you customise the LONG coffee by using the preground coffee, a second measure will be requested.

MAKING CAPPUCCINOS AND MILK BASED COFFEES

i Please note!

- To avoid producing milk with poor froth or large bubbles, always clean the milk container lid and hot water connection nozzle as described in the section “Cleaning the milk container” on pages 14 and 17.

Filling and attaching the milk container

1. Remove the lid (fig. 19);
2. Fill the milk container with a sufficient quantity of milk, not exceeding the MAX level marked on the handle (fig. 20). Each mark on the side of the container corresponds to around 100 ml of milk.



i Please note!

- For a denser more even froth, you must use skimmed or partially skimmed milk at refrigerator temperature (about 5°C).
 - If “Energy saving” mode is enabled, you may have to wait a few seconds before the first coffee is delivered.
3. Make sure the milk intake tube is correctly inserted in the bottom of the milk container lid (fig. 21).
 4. Place the lid back on the milk container.
 5. Remove the hot water spout (D5), by pressing the button on the spout (fig. 22A)

- Attach the milk container to the connection nozzle and push as far as it will go (fig. 23). The machine emits a beep (if the beep function is enabled).
- Place a sufficiently large cup under the coffee and frothed milk spouts. Adjust the length of the milk spout. To move it nearer the cup, simply pull it downwards (fig. 24).
- Follow the instructions below for each function.
- Press < or > until the required drink is displayed (MILK, CAFFELATTE, ESPRESSO MACCHIATO or MY MILK).
- Press the **OK** button to start making the drink.
- After a few seconds, frothed milk is delivered from the milk spout into the cup below.
For drinks with coffee, the machine automatically makes the coffee after delivering the milk.

Adjusting the amount of froth

Turn the froth adjustment dial to adjust the amount of froth on the milk delivered while making cappuccino and milk based coffees.

Dial position	Description	Recommended for...
	No froth	CAFFELATTE / MILK (hot milk)
	Min. froth	LATTE / FLAT WHITE
	Max. froth	CAPPUCCINO / MILK (frothed milk) / ESPRESSO MACCHIATO

Making milk based coffees automatically

The control panel features buttons for automatically making CAPPUCCINO, FLAT WHITE, and LATTE.

To make one of these coffees, proceed as follows:

- Fill the milk container and attach it as described above.
- Turn the froth adjustment dial on the milk container lid to the position corresponding to the required froth.
- Press the button corresponding to the required coffee: the name of the coffee is displayed, together with a progress bar which fills gradually as preparation proceeds.
- After a few seconds, frothed milk is delivered from the milk spout into the cup below.
Subsequently, the machine automatically makes the coffee after having delivered the milk.

Making hot drinks using the "MILK MENU"

As well as the coffees described above, the machine automatically makes MILK (hot milk), CAFFELATTE, ESPRESSO MACCHIATO and MY MILK (customisable).

To make one of these hot drinks, proceed as follows:

- Fill the milk container and attach it as described above.
- Turn the froth adjustment dial on the milk container lid to the position corresponding to the required froth.
- Press the **MILK MENU** button.

Please note: general instructions for all milk based preparations

- If during delivery you want to stop preparation, press any button once.
- At the end of delivery, to increase the quantity of milk or coffee in the cup, within 3 seconds, press and hold one of the buttons corresponding to the milk based drinks.
- Do not leave the milk container out of the refrigerator for long periods. The warmer the milk (5°C is ideal), the poorer the quality of froth produced.

Cleaning the milk container after use

Important! Danger of burns

When cleaning the internal tubes of the milk container, a little hot water and steam leak out of the frothed milk spout.

Avoid contact with splashes of water.

"SET DIAL TO CLEAN" flashes on the display each time you use a milk function. To eliminate all milk residues, proceed as follows:

- Leave the milk container in the machine (you do not need to empty it);
- Place a cup or other recipient under the frothed milk spout.
- Turn the froth adjustment dial to "CLEAN" (fig. 25). A progress bar appears and gradually fills as the operation proceeds together with "Cleaning underway". Cleaning stops automatically.
- Turn the dial back to one of the froth selections.
- Remove the milk container and always clean the steam connection nozzle with a sponge (fig. 26).

Please note!

- To prepare a number of cappuccinos or milk based coffees, clean the milk container after you have prepared the last drink only.
- The milk container can be kept in the refrigerator.
- In some cases, to clean you must wait for the appliance to heat up.

Programming the quantity of coffee and milk in the cup for the CAPPUCCINO, FLAT WHITE and LATTE buttons

The appliance is set by default to automatically deliver standard quantities. To change these quantities, proceed as follows:

1. Place a cup under the coffee spouts and milk spout.
2. Press and hold one of the function buttons until the name of the hot drink and the message "PROGRAM MILK" is displayed.
3. Release the button. The appliance starts delivering milk.
4. Once the required quantity of milk has been delivered into the cup, press the button again.
5. The appliance stops delivering milk and, if included in the drink, after a few seconds the coffee is delivered into the cup: the name of the hot drink and "PROGRAM COFFEE" is displayed.
6. Once the required quantity of coffee has been delivered into the cup, press the button again. Coffee delivery stops.

The machine is now reprogrammed with the new milk and coffee quantities.

Programming the quantity of coffee and milk in the cup for the MILK MENU button drinks

The appliance is set by default to automatically deliver standard quantities.

To change these quantities, proceed as follows:

1. Press the **MILK MENU** button.
2. Press < or > until the required drink is displayed (MILK, CAFFELATTE, ESPRESSO MACCHIATO or MY MILK).
3. Hold the **OK** button until the name of the drink and "PROGRAM MILK" are displayed.
4. Release the button. The appliance starts delivering milk.
5. Once the required quantity of milk has been delivered into the cup, press the **OK** button.
6. The appliance stops delivering milk and, if included in the drink, after a few seconds the coffee is delivered into the cup: the name of the hot drink and "PROGRAM COFFEE" is displayed.
7. Once the required quantity of coffee has been delivered into the cup, press the **OK** button again. Coffee delivery stops.

The machine is now reprogrammed with the new milk and coffee quantities.

DELIVERING HOT WATER AND STEAM



Important! Danger of burns.

Never leave the machine unsupervised while delivering hot water or steam.



The spout becomes hot. Hold by the handle only.



Please note!

If "Energy saving" mode is active, you may have to wait a few seconds before the hot water or steam is delivered.



Delivering hot water

1. Make sure the hot water spout is attached correctly (fig. 7).
2. Place a container under the spout (as close as possible to avoid splashes).
3. Press the  button (fig. 3). "HOT WATER" is displayed, together with a progress bar which fills gradually as preparation proceeds.
4. The machine delivers 250 ml of hot water, then delivery stops automatically. To interrupt delivery of hot water manually, press the  button again.

Changing the quantity of water delivered automatically



The machine is set by default to automatically deliver 250 ml of hot water.

To modify these quantities, proceed as follows:

1. Position a container under the spout.
2. Press and hold the  button until "Hot water Program quantity" is displayed, then release the  button.
3. When the hot water in the cup reaches the required level, press the  button again.

The machine is now reprogrammed with the new quantity.

Delivering steam

1. Make sure the hot water spout is attached correctly (fig. 7).
2. Fill a container with the liquid to be heated/frothed and immerse the spout/cappuccino maker (D5) in the liquid.
3. Press the  button: after a few seconds, steam comes out of the cappuccino maker and heats the liquid; "STEAM" is displayed.
4. When the required temperature is obtained, interrupt steam delivery by pressing the  button. (You should not discharge steam for more than 3 minutes at a time).



Important!

Always stop steam delivery before extracting the container containing the liquid to avoid burns from splashes.

Tips for using steam to froth milk

- When choosing the size of the container, bear in mind that the liquid doubles or triples in volume.
- For a richer denser froth, use skimmed or partially skimmed milk at refrigerator temperature (about 5°C).
- For a creamier froth, rotate the container with slow movements in an upward direction.

- To avoid milk with poor froth or large bubbles, always clean the spout as described in the following section.

Cleaning the spout after use

Always clean the spout after use to avoid the build-up of milk residues and prevent the spout from clogging.

1. Place a container under the cappuccino maker and press the ☼ button to deliver a little water (fig. 3). Stop the flow of hot water by pressing the ☼ button again.
2. Wait a few minutes for the cappuccino maker to cool down, then press the button on the hot water spout and extract it (fig. 27A). Hold the spout with one hand and with the other, turn the cappuccino maker anticlockwise (fig. 27B) and pull downwards to remove.
3. Also remove the steam connection nozzle by pulling it downwards (fig. 28).
4. Check the hole shown by the arrow in fig. 29 is not blocked. If necessary, clean with a pin.
5. Wash all parts of the cappuccino maker thoroughly with a sponge and warm water.
6. Reinsert the nozzle and replace the cappuccino maker on the nozzle, pushing it upwards and turning it until it is attached.

CLEANING

Cleaning the machine

The following parts of the machine must be cleaned regularly:

- coffee grounds container (A10),
- drip tray (A12),
- water tank (A16),
- coffee spouts (A7),
- hot water/steam connection nozzle (A8)
- pre-ground coffee funnel (A4),
- the infuser (A15), accessible after opening the service door (A14),
- control panel (B)
- milk container (C)



Important!

- Do not use solvents, abrasive detergents or alcohol to clean the appliance. With De'Longhi superautomatic coffee machines, you need not use chemical products to clean the machine.
- None of the components of the appliance can be washed in a dishwasher with the exception of the milk container (C).
- Do not use metal objects to remove encrustations or coffee deposits as they could scratch metal or plastic surfaces.

Cleaning the coffee grounds container

When "EMPTY GROUNDS CONTAINER" is displayed, the grounds container must be emptied and cleaned.

Until the grounds container has been cleaned, the appliance will not make coffee.

Even if not full, the empty grounds container message is displayed 72 hours after the first coffee has been prepared. For the 72 hours to be calculated correctly, the machine must never be turned off using the main switch.



Important! Danger of burns

If you make a number of cappuccinos one after the other, the metal cup tray becomes hot. Wait for it to cool down before touching it and handle it from the front only.

To clean (with the machine on):

- Extract the drip tray (fig. 30), empty and clean.
- Empty the grounds container and clean thoroughly to remove all residues left on the bottom. This can be done with the spatula on the brush provided.
- Check the condensate tray and empty if necessary (fig. 31).



Important!

When removing the drip tray, the grounds container must be emptied, even if it contains few grounds.

If this is not done, when you make the next coffees, the grounds container may fill up more than expected and clog the machine.

Cleaning the drip tray and condensate tray



Important!

The drip tray is fitted with a level indicator (red) showing the level of water it contains (fig. 32).

Before the indicator protrudes from the cup tray, the drip tray must be emptied and cleaned, otherwise the water may overflow the edge and damage the appliance, the surface it rests on or the surrounding area.

To remove the drip tray:

1. Extract the drip tray and grounds container (fig. 30);
2. Empty the drip tray and grounds container and wash them;
3. Check the condensate tray and empty if necessary.
4. Replace the drip tray complete with grounds container.

Cleaning the inside of the coffee machine



Danger of electric shock!

Before cleaning internal parts, the machine must be turned off (see "Turning off") and unplugged from the mains power supply. Never immerse the coffee machine in water.

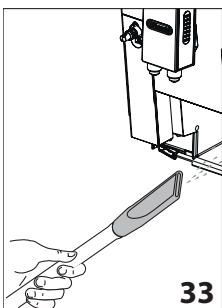

1. Check regularly (about once a week) that the inside of the appliance (accessible after removing the drip tray) is not dirty. If necessary, remove coffee deposits with the brush supplied and a sponge.
2. Remove the residues with a vacuum cleaner (fig. 33).

Cleaning the water tank

1. Clean the water tank (A16) regularly (about once a month and whenever you replace the water softener filter (if present) with a damp cloth and a little mild washing up liquid.
2. Remove the filter (if present) and rinse with running water.
3. Replace the filter (if present), fill the tank with fresh water and replace the tank.

Cleaning the coffee spouts

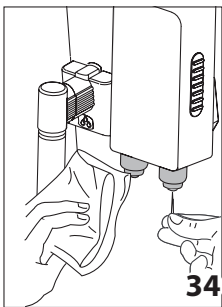

1. Clean the coffee spouts regularly with a sponge or cloth (fig. 34).
2. Check the holes in the coffee spout are not blocked. If necessary, remove coffee deposits with a toothpick (fig. 34).

Cleaning the pre-ground coffee funnel

Check regularly (about once a month) that the pre-ground coffee funnel (A4) is not blocked.

If necessary, remove coffee deposits with the brush (D2) supplied.

Cleaning the infuser

The infuser (A15) must be cleaned at least once a month.



Important!

The infuser may not be extracted when the machine is on.

1. Make sure the machine is correctly turned off (see "Turning off", page "TURNING THE APPLIANCE OFF" a pagina 9).
2. Extract the water tank (fig. 4).
3. Open the infuser door (fig. 35) on the right side of the appliance.

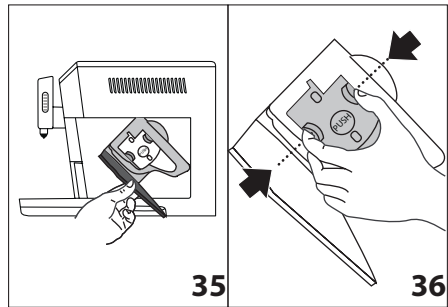

4. Press the two red release buttons inwards and at the same time pull the infuser outwards (fig. 36).
5. Soak the infuser in water for about 5 minutes, then rinse under the tap.



Important!

RINSE WITH WATER ONLY

NO WASHING UP LIQUID - NO DISH WASHER

Clean the infuser without using washing up liquid as it could be damaged.

6. Use the brush (D2) to remove any coffee residues left in the infuser housing, visible through the infuser door.
7. After cleaning, replace the infuser by sliding it onto the internal support (fig. 37), then push the PUSH symbol fully in until it clicks into place.

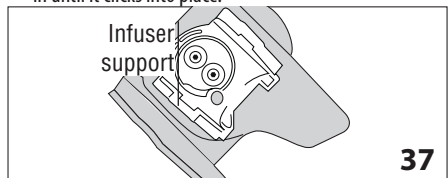

Please note!

If the infuser is difficult to insert, before insertion, adapt it to the right size by pressing the two levers shown in fig. 38.

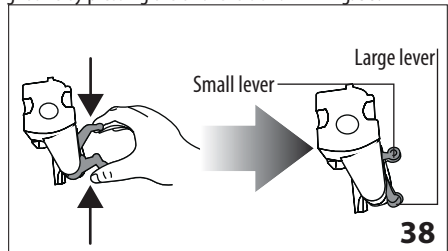

8. Once inserted, make sure the two red buttons have snapped out (fig. 39).

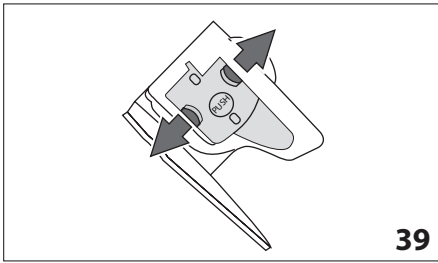

9. Close the infuser door.
10. Replace the water tank.

Cleaning the milk container

Clean the milk container every two days as described below:

1. Remove the lid.
2. Remove the milk spout and intake tube.
3. Turn the froth adjustment dial clockwise to the "INSERT" position (fig. 40) and pull off upwards.

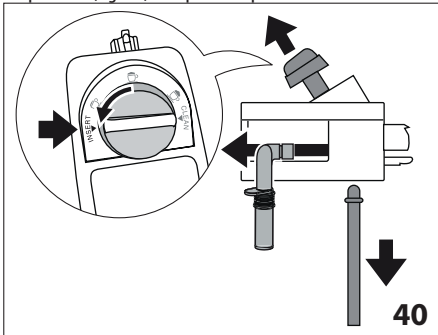

4. Wash all the components thoroughly with hot water and mild washing-up liquid. All components are dishwasher safe, placing them in the top basket of the dishwasher. Make sure there are no milk residues on the hollow and groove under the dial (fig. 41). If necessary, scrape the groove with a toothpick.

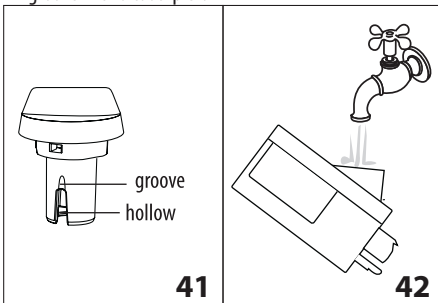

5. Rinse inside the froth adjustment dial seat with running water (fig. 42)

6. Check that the intake tube and spout are not clogged with milk residues.
7. Replace the dial (in correspondence to the word "INSERT"), spout and milk intake tube.
8. Place the lid back on the milk container.

Cleaning the hot water/steam connection nozzle

Each time you prepare milk, clean the connection nozzle with a sponge to remove milk residues from the gaskets (fig. 26).

DESCALING

Descal the machine when the message "DESCALE" flashes on the display.



- Descaler contains acids which may irritate the skin and eyes. It is vital to respect the manufacturer's safety warnings given on the descaler pack and the warnings relating to the procedure to follow in the event of contact with the skin and eyes.
- You should use De'Longhi descaler only. Using unsuitable descaler and/or performing descaling incorrectly may result in faults not covered by the manufacturer's guarantee.

1. Turn the machine on.
2. Press the **MENU/ESC** button to enter the menu.
3. Press < > until "Descal" is displayed.
4. Select by pressing the **OK** button: Confirm? is displayed. Press the **OK** button to confirm.
5. "EMPTY THE DRIP TRAY" is displayed, alternating with "REMOVE FILTER" (if the filter is featured) and "ADD DESCALER, Press OK".
6. Empty the water tank (A16) completely and remove the water softener filter (if present). Empty the drip tray (fig. 30) and grounds container, then put them back in the appliance.

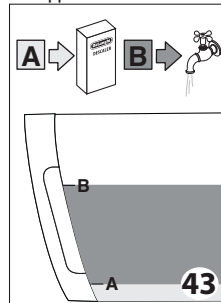

7. Pour the descaler into the tank up to level **A** (corresponding to a 100 ml pack) marked on the back of the tank (fig. 43), then add water (1 litre) up to level **B** (fig. 43) and put the water tank back.
8. Place an empty container with a minimum capacity of 1.5 litres under the hot water spout (fig. 7).



Hot water containing acid flows out of the hot water spout.

Avoid contact with splashes of water.

9. Press the **OK** button to confirm that you have added the solution. The descale programme automatically performs a series of rinses and pauses to remove limescale deposits from inside the machine.

“Descalce underway” is displayed. The descalce programme starts, and descaler comes out of the water spout.

After about 30 minutes, the message “RINSING, INSERT FILTER” (if removed previously) is displayed, alternating with “FILL TANK”.

10. The appliance is now ready for rinsing through with clean water. Extract the water tank, empty, rinse under running water, fill with clean water up to the MAX level, insert the filter (if removed previously) and put the water tank back in the machine. “RINSING, Press OK” is displayed.
11. Empty the container used to collect the descaler solution and replace it empty under the hot water spout.
12. Press the **OK** button to start rinsing. Hot water flows out of the spout and the message “RINSING, Please wait” is displayed.
13. When the water tank is completely empty, the message “Rinsing complete, Press OK” is displayed.
14. Press the **OK** button.
15. “Heating up Please wait” is displayed, at the end of which the machine will be ready for use.

SETTING WATER HARDNESS

The DESCALC message is displayed after a period of time established according to water hardness.

The machine is set by default for a hardness value of 4.

The machine can also be programmed according to the hardness of the mains water in the various regions so that the machine needs to be descaled less often.

Measuring water hardness

1. Remove the “TOTAL HARDNESS TEST” indicator paper from its pack (attached to the English instructions).
2. Immerse the paper completely in a glass of water for one second.
3. Remove the paper from the water and shake lightly. After about a minute, 1, 2, 3, or 4 red squares form, depending on the hardness of the water. Each square corresponds to one level.

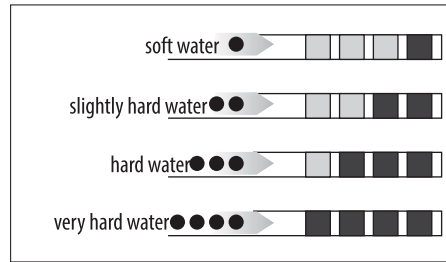

Setting water hardness

1. Press the **MENU/ESC** button to enter the menu.
2. Press < or > to select “Water hardness”.
3. Press the **OK** button to confirm the selection.
4. Press < or > and set the hardness level as measured by the indicator strip (see the fig. in the previous paragraph).
5. Press the **OK** button to confirm the setting.
6. Press the **MENU/ESC** button to exit the menu.

The machine is now reprogrammed with the new water hardness setting.

WATER SOFTENER FILTER

Certain models are fitted with a water softener filter. If this is not the case with your model, you are recommended to purchase one from De’Longhi Customer Services.

To use the filter correctly, follow the instructions below.

Installing the filter

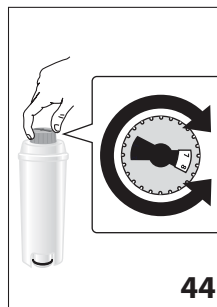

1. Remove the filter from the packaging.
2. Turn the date indicator disk (fig. 44) until the next two months of use are displayed.

i Please note

The filter lasts about two months if the appliance is used normally. If the coffee machine is left unused with the filter installed, it will last a maximum of three weeks.

3. To activate the filter, run tap water through the hole in the filter as shown in the figure until water comes out of the openings at the side for more than a minute (fig. 45).

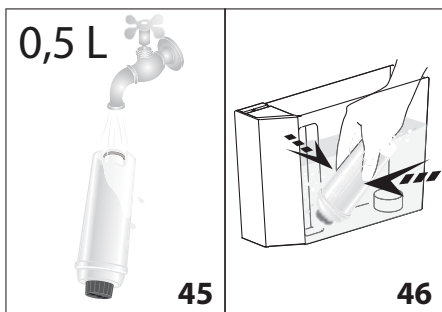

4. Extract the tank from the appliance and fill with water.
5. Insert the filter in the water tank and immerse it completely for about ten minutes, sloping it and pressing it lightly to enable the air bubbles to escape (fig. 46).
6. Insert the filter in the filter housing (fig. 47A) and press as far as it will go.
7. Close the tank with the lid (fig. 47B), then put the tank back in the machine.

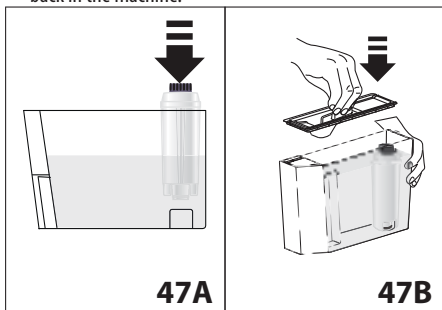

When you install the filter, you must notify the appliance of its presence.

8. Press the **MENU/ESC** button to enter the menu;
9. Press < or > (fig. 9) until "Install filter" is displayed;
10. Press the **OK** button;
11. "Install?" is displayed;
12. Press the **OK** button to confirm the selection. "Water delivery Press OK" is displayed;
13. Position a container under the hot water spout (min. capacity: 500 ml).
14. Press the **OK** button to confirm the selection. The appliance begins hot water delivery and the message "Please wait" is displayed.
15. After delivery, the appliance is automatically ready to make the next drink.

The new filter is active. You can now use the appliance.

Replacing the filter

When "REPLACE FILTER" is displayed, after two months (see date indicator) or when the appliance has not been used for 3 weeks, you should replace the filter:

1. Extract the tank and exhausted filter;
2. Take the new filter out of its packet and proceed as illustrated in points 2-3-4-5-6-7 in the previous section;
3. Position a container with a minimum capacity of 500 ml under the hot water spout;
4. Press the **MENU/ESC** button to enter the menu;
5. Press < or > until "Replace filter" is displayed;
6. Press the **OK** button;
7. "Confirm?" is displayed;
8. Press the **OK** button to confirm the selection;
9. "Water delivery Press OK" is displayed;
10. Press the **OK** button to confirm the selection. The appliance begins hot water delivery and the message "Please wait" is displayed;
11. After delivery, the appliance is automatically ready to make the next drink.

The new filter is now active and you can use the coffee machine.

Removing the filter

If you want to use the appliance without the filter, you must remove it and notify the appliance of its removal. Proceed as follows:

1. Extract the tank and exhausted filter;
2. Press the **MENU/ESC** button to enter the menu;
3. Press < or > (fig. 9) until "Install filter, Enabled" is displayed;
4. Press the **OK** button;
5. "Disable?" is displayed;
6. Press the **OK** button to confirm and the **MENU/ESC** button to exit the menu.

TECHNICAL DATA

Voltage:	220-240 V~ 50/60 Hz max. 10A
Absorbed power:	1450W
Pressure:	15 bar
Max. water tank capacity:	2 l
Size LxHxD:	260 x 360 x 460 mm
Cable length:	1,75 m
Weight:	11 kg
Coffee beans container capacity:	400 g

CE The appliance complies with the following EC directives:

- Low Voltage Directive 2006/95/EC and subsequent amendments;
- EMC Directive 2004/108/EC and subsequent amendments;
- European Stand-by Regulation 1275/2008;
- Materials and accessories coming into contact with food conform to EC regulation 1935/2004.

DISPLAYED MESSAGES



DISPLAYED MESSAGE	POSSIBLE CAUSE	SOLUTION
FILL TANK	Insufficient water in the tank.	Fill the tank with water and/or insert it correctly, pushing it as far as it will go until it clicks into place.
EMPTY GROUNDS CONTAINER	The grounds container (A10) is full.	Empty the grounds container and drip tray, clean and replace (fig. 30). Important: when removing the drip tray, the grounds container MUST be emptied, even if it contains few grounds. If this is not done, when you make the next coffees, the grounds container may fill up more than expected and clog the machine. If the problem persists, make sure the water tank is fully inserted, press the ☉ button and deliver a little water from the spout.
GROUND TOO FINE ADJUST MILL	The grinding is too fine and the coffee is delivered too slowly or not at all.	Repeat coffee delivery and turn the grinding adjustment dial (fig. 14) one click clockwise towards "7" while the coffee mill is in operation. If after making at least 2 coffees delivery is still too slow, repeat the correction procedure, turning the grinding adjustment dial another click until delivery is correct (see the section: "Adjusting the coffee mill on page 12).
INSERT GROUNDS CONTAINER	After cleaning, the grounds container has not been replaced.	Remove the drip tray and insert the grounds container.
ADD PRE-GROUND COFFEE	With the pre-ground function selected, pre-ground coffee has not been poured into the funnel.	Place pre-ground coffee in the funnel or deselect the "pre-ground" function (fig. 18).
DESCALE	The machine must be descaled.	The descaling procedure described in the section "Descaling" needs to be performed as soon as possible (page 18).
LESS COFFEE	Too much coffee has been used.	Select a milder taste by pressing the ☉ button (fig. 11) or reduce the quantity of pre-ground coffee.
FILL BEANS CONTAINER	The coffee beans have run out.	Fill the beans container (fig. 15).
	The pre-ground coffee funnel is clogged.	Empty the funnel with the help of a brush as described in the section "Cleaning the pre-ground coffee funnel" (page 18).
INSERT INFUSER ASSEMBLY	The infuser has not been replaced after cleaning.	Insert the infuser as described in the paragraph "Cleaning the infuser" (page 17).
INSERT TANK	The tank is not correctly in place.	The tank is not correctly in place.

GENERAL ALARM	The inside of the appliance is very dirty.	Clean the inside of the appliance thoroughly, as described in the section "Cleaning". If the message is still displayed after cleaning, contact a service centre.
EMPTY CIRCUIT, FILL CIRCUIT Water delivery PRESS OK	The water circuit is empty	Press OK and deliver water from the spout (D5), until it flows out normally.
REPLACE FILTER	The water softener filter is exhausted.	Replace the filter or remove it as described in the section "Water softener filter".
SET DIAL TO CLEAN	Milk has been delivered recently and the tubes inside the milk container must be cleaned.	Turn the froth adjustment dial to CLEAN.
INSERT WATER SPOUT	The hot water spout is not inserted or is inserted incorrectly.	Insert the water spout (D5) as far as it will go.
INSERT MILK CONTAINER	The milk container is not inserted correctly.	Insert the milk container (fig. 23) as far as it will go.

TROUBLESHOOTING

Below is a list of some of the possible malfunctions. If the problem cannot be resolved as described, contact Customer Services.

PROBLEM	POSSIBLE CAUSE	SOLUTION
The coffee is not hot	The cups were not preheated.	<ul style="list-style-type: none"> Enable the cup warmer and let the cups heat up for at least 20 min. Warm the cups by rinsing them with hot water (Please note: you can use the hot water function).
	The infuser has cooled down because 2/3 minutes have elapsed since the last coffee was made.	Before making coffee, use the special function to rinse and heat the infuser (page 10).
	A low coffee temperature is set.	Set a higher coffee temperature in the menu (page 11).
The coffee is weak or not creamy enough.	The coffee is ground too coarsely.	Turn the grinding adjustment dial one click anticlockwise towards "1" while the coffee mill is in operation (fig. 14). Continue one click at a time until coffee delivery is satisfactory. The effect is only visible after delivering 2 coffees (see the section: "Adjusting the coffee mill" on page 12).
	The coffee is unsuitable.	Use pre-ground coffee for espresso machines.
The coffee is delivered too slowly or a drop at a time.	The coffee is ground too finely.	Turn the grinding adjustment dial one click clockwise towards "7" while the coffee mill is in operation (fig. 14). Continue one click at a time until coffee delivery is satisfactory. L'effetto è visibile solo dopo l'erogazione di 2 caffè (vedi paragrafo "regolazione del macinacaffè", page 12).

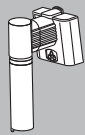
Coffee does not come out of one of the spouts.	The spouts are blocked.	Clean the spouts with a toothpick (fig. 34).
The appliance does not come on.	The power cable is not plugged in properly.	Plug the cable fully into the socket on the back of the appliance (fig. 1).
	It is not plugged into the mains socket.	Plug into the mains socket.
	The main switch (A20) is not turned on.	Press the main switch (fig. 2).
The infuser cannot be extracted.	The appliance has not been turned off correctly.	Turn the appliance off by pressing the  button (page 9).
 <p>The milk does not come out of the milk spout.</p> <p>The milk contains large bubbles and squirts out of the milk spout or there is little froth.</p>	The milk container lid is dirty.	Clean the milk container lid as described in the section "Cleaning the milk container" (page 17).
	The milk is not cold enough or is not semi-skimmed.	Use skimmed or semi-skimmed milk at refrigerator temperature (about 5° C). If the result is not as you wished, try changing brand of milk.
	The froth adjustment dial is incorrectly adjusted.	Adjust following the instructions in the section "Making cappuccinos and milk based coffees" (page 13).
	The milk container lid or froth adjustment dial are dirty.	Clean the milk container lid and dial as described in the section "Cleaning the milk container" (page 17).
	The hot water/steam connection nozzle is dirty	Clean the connection nozzle as described in the section "Cleaning the hot water/steam nozzle" (page 18).
 <p>The milk contains large bubbles or squirts out of the milk spout, or is not well frothed.</p>	The spout is dirty.	Clean as described in the section "Cleaning the cappuccino maker after use" (page 15).

DISPOSAL



In compliance with European directive 2002/96/EC, the appliance must not be disposed of with household waste, but taken to an authorised waste separation and recycling centre.

ELECTRICAL CONNECTION (UK ONLY)

Before using this appliance ensure that the voltage indicated on the product corresponds with the main voltage in your home, if you are in any doubt about your supply contact your local electricity company.

The flexible mains lead is supplied connected to a B.S. 1363 fused plug having a fuse of 13 amp capacity.

Should this plug not fit the socket outlets in your home, it should be cut off and replaced with a suitable plug, following the procedure outlined below.

Note: Such a plug cannot be used for any other appliance and should therefore be properly disposed of and not left where children might find it and plug it into a supply socket - with the obvious consequent danger.

Please note: We recommend the use of good quality plugs and wall sockets that can be switched off when the machine is not in use.

IMPORTANT: The wires in the mains lead fitted to this appliance are coloured in accordance with the following code:

GREEN AND YELLOW
BLUE
BROWN

EARTH
NEUTRAL
LIVE

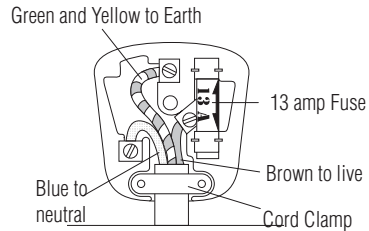

As the colours of the wires in the mains lead of this appliance may not correspond with the coloured markings identifying the terminals in your plug, proceed as follows:

- The wire which is coloured green and yellow must be connected to the terminal in the plug which is marked with the letter E or by the earth symbol  or coloured green or green and yellow.
- The wire which is coloured blue must be connected to the terminal which is marked with the letter N or coloured black.
- The wire which is coloured brown must be connected to the terminal which is marked with the letter L or coloured red.

When wiring the plug, ensure that all strands of wire are securely retained in each terminal. Do not forget to tighten the mains lead clamp on the plug. If your electricity supply point has only two pin socket outlets, or if you are in doubt, consult a qualified electrician.

Should the mains lead ever require replacement, it is essential that this operation be carried out by a qualified electrician and should only be replaced with a flexible cord of the same size.

After replacement of a fuse in the plug, the fuse cover must be refitted. If the fuse cover is lost, the plug must not be used until a replacement cover is obtained. The colour of the correct replacement fuse cover is that of the coloured insert in the base of the fuse recess or elsewhere on the plug. Always state this colour when ordering a replacement fuse cover.

Only 13amp replacement fuses which are asta approved to B.S. 1362 should be fitted.

This appliance conforms to the Norms EN 55014 regarding the suppression of radio interference.

Warning - this appliance must be earthed