



**UniFi**® | AP AC PRO

802.11ac Dual-Radio  
Pro Access Point

Model: UAP-AC-PRO

QUICK START GUIDE

## Introduction

Thank you for purchasing the Ubiquiti Networks® UniFi® 802.11ac Dual-Radio Pro Access Point. This Quick Start Guide is designed to guide you through installation and includes warranty terms.

**!** **IMPORTANT:** The UAP-AC-PRO requires the UniFi Controller v5.4 or higher, available at: [www.ubnt.com/download/unifi](http://www.ubnt.com/download/unifi)

## Package Contents



UniFi AP AC Pro



Mounting Bracket



Ceiling Backing Plate



Flat Head Screws  
(Qty. 4)



Keps Nuts  
(Qty. 4)



Screws  
(Qty. 4)



Screw Anchors  
(Qty. 4)



Cable Feed Plug



Gigabit PoE\* (48V, 0.5A)  
with Mount Bracket



Power Cord\*

\* Included only in the single-pack of the UAP-AC-PRO

**TERMS OF USE:** Ubiquiti radio devices must be professionally installed. Shielded Ethernet cable and earth grounding must be used as conditions of product warranty. TOUGHCable™ is designed for outdoor installations. It is the professional installer's responsibility to follow local country regulations, including operation within legal frequency channels, output power, and Dynamic Frequency Selection (DFS) requirements.

## Installation Requirements

- Phillips screwdriver
- Drill and drill bit (6 mm for wall-mounting or 3 mm for ceiling-mounting)
- Optional: Drywall or keyhole saw (to cut 18 mm hole for Ethernet cable feed)
- Cat5/6 UTP cable for indoor installations

## Outdoor Installation Requirements

 **IMPORTANT:** The UAP-AC-PRO may be installed outdoors under an eave or other protected location. Do not install the UniFi AP in an open environment.

- Mounting location should be at least 60 cm (2 ft) from the edge of the eave or ceiling.
- Cable feed opening must be directed away from the open environment.
- Cable feed must be pointed downwards when wall-mounted.
- Shielded Category 5 (or above) cabling with drain wire should be used for all outdoor wired Ethernet connections and should be grounded through the AC ground of the PoE.

We recommend that you protect your networks from harmful outdoor environments and destructive ESD events with industrial-grade, shielded Ethernet cable from Ubiquiti Networks. For more details, visit

**[www.ubnt.com/toughcable](http://www.ubnt.com/toughcable)**

## System Requirements

- Linux, Mac OS X, or Microsoft Windows 7/8/10
- Java Runtime Environment 1.8 or above recommended
- Web Browser: Google Chrome (Other browsers may have limited functionality.)
- UniFi Controller software v5.4 or newer (available at: **[www.ubnt.com/download/unifi](http://www.ubnt.com/download/unifi)**)

## Network Topology Requirements

- A DHCP-enabled network (for the AP to obtain an IP address as well as for the wireless clients after deployment)
- A UniFi Cloud Key or management station running the UniFi Controller v5.4 (or newer) software, located either on-site and connected to the same Layer-2 network, or off-site in the cloud or NOC

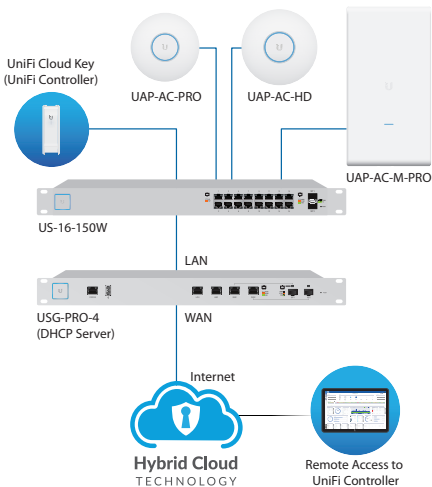

*Sample Network Diagram*

All UniFi devices support off-site management controllers. For setup details, see the User Guide on the website:  
[www.ubnt.com/download/unifi](http://www.ubnt.com/download/unifi)

## Hardware Overview

### LED



LED Color	Status
White	Factory default, waiting to be integrated.
Flashing White	Initializing.
Alternating White/Blue	Device is busy; do not touch or unplug it. This usually indicates that a process such as a firmware upgrade is taking place.
Blue	Indicates the device has been successfully integrated into a network and is working properly.
Quickly Flashing Blue	This is used to locate an AP. When you click <b>Locate</b> in the UniFi Controller software, the AP will flash. It will also display the location of the AP on the map.
Steady Blue with Occasional Flashing	Indicates the device is in an isolated state (all WLANs are brought down until an uplink is found).

## Ports

Security Slot

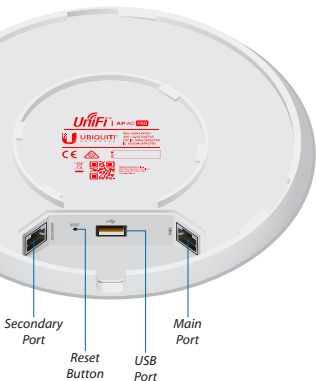

Secondary Port

Reset Button

USB Port

Main Port

**Secondary** The *Secondary* port is a Gigabit Ethernet port used for bridging.

**Reset** The *Reset* button serves two functions for the UniFi AP:

- **Restart** Press and release the *Reset* button quickly.
- **Restore to Factory Default Settings** Press and hold the *Reset* button for more than five seconds.

**USB** The *USB* port is reserved for future use.

**Main** The *Main* port is a Gigabit Ethernet port used to connect the power and should be connected to the LAN and DHCP server.



**Note:** If you need to remove the UniFi AP from the *Mounting Bracket*, insert a paper clip in the *Security Slot* to release the *Lock Tab* and turn the UniFi AP counterclockwise.

## Upgrade from UAP-PRO

The design of the UAP-AC-PRO *Mounting Bracket* facilitates upgrades from the UAP-PRO, by eliminating the need to drill new holes in the wall or ceiling tile. The following illustrations show the *Mounting Bracket* holes that are used for the UAP-AC-PRO and UAP-PRO:



*Mounting Bracket Holes (4)  
for UAP-AC-PRO*



*Mounting Bracket Holes (3)  
for UAP-PRO*

To begin the upgrade, perform the following steps:

1. Insert a paper clip into the UAP-PRO *Locking Notch* to disengage the lock. Then turn the UAP-PRO counterclockwise and lift it off of the mounting bracket.

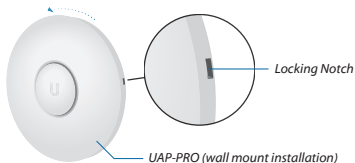

2. Unscrew the three screws holding the mounting bracket to the wall or ceiling tile.
3. Go to step 3 of the *Wall Mount* section or step 4 of the *Ceiling Mount* section.

## Hardware Installation

The UniFi AP can be mounted on the wall or ceiling. Perform the steps for the appropriate installation:

### Wall Mount

1. Position the *Mounting Bracket* at the desired location on the wall with the *Arrow* pointing up.
2. Mark the four mounting holes, and use a 6 mm drill bit to drill the holes. If your Ethernet cable feeds through the wall, cut or drill a circle approximately 18 mm in diameter. Then feed the CAT5/6 cable through the hole.

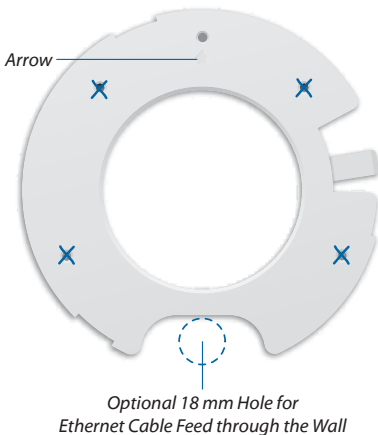



3. Insert the *Screw Anchors* into the 6 mm holes. Secure the *Mounting Bracket* to the wall by inserting the *Screws* into the anchors.

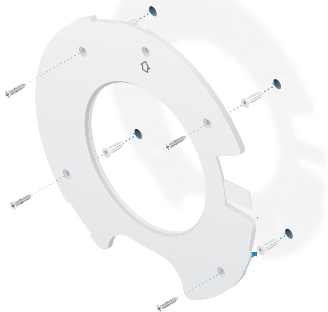

**Note:** If upgrading from the UAP-PRO, secure the new *Mounting Bracket* to the wall using the existing holes.

4. Remove the rubber port cover from the UniFi AP.

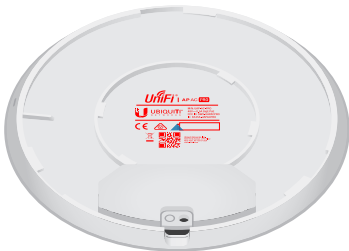

5. If the Ethernet cable runs along the mounting surface, skip to step 6. If the Ethernet cable is fed through the wall or ceiling, insert the *Cable Feed Plug*.



6. Feed the Ethernet cable through the port cover.



**Note:** The feed hole will stretch to accommodate the RJ45 connector, and then seal around the cable.

7. Connect the Ethernet cable to the *Main* port and replace the port cover.

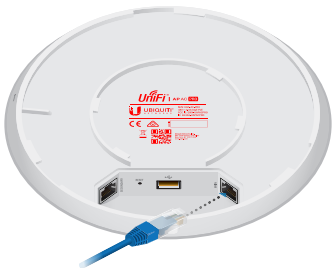

8. Align the *Notch* on the top edge of the UniFi AP with the *Arrow* on the *Mounting Bracket*.

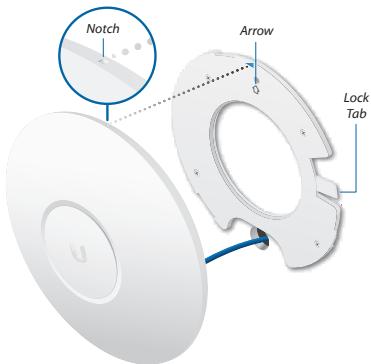

9. Rotate the UniFi AP clockwise until the tabs lock into place and the *Lock Tab* engages.



## Ceiling Mount

1. Remove the ceiling tile.
2. Place the *Ceiling Backing Plate* in the center of the ceiling tile. Mark the four mounting screw holes and an 18 mm hole for the Ethernet cable feed.

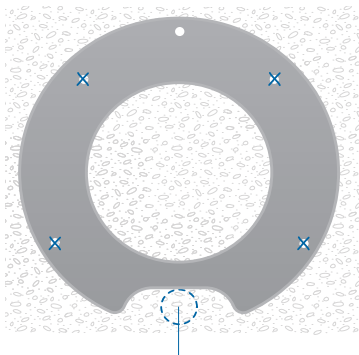

*18 mm Hole for Ethernet Cable Feed*

3. Use a 3 mm drill bit to drill the screw holes, and cut or drill the hole for the Ethernet cable feed.

4. Insert the *Flat Head Screws* through the *Mounting Bracket*, ceiling tile, and *Ceiling Backing Plate* (see note below). Fasten the screws using the *Keps Nuts*. Then feed the Ethernet cable through the tile and bracket.

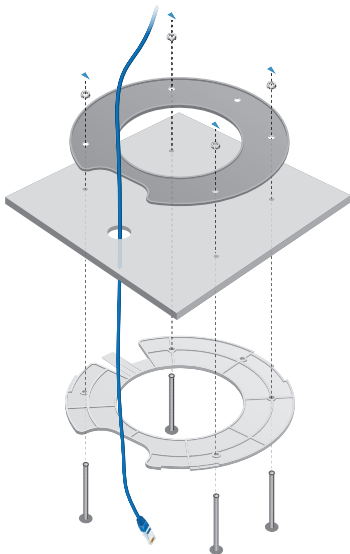

**Note:** If upgrading from the UAP-PRO, insert the *Flat Head Screws* through the new *Mounting Bracket*, the ceiling tile, and the *Ceiling Backing Plate*. (Either re-use the UAP-PRO *Ceiling Backing Plate* or replace it with the new UAP-AC-PRO plate.)

5. Insert the *Cable Feed Plug*.

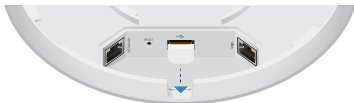

6. Remove the port cover from the UniFi AP, and then feed the Ethernet cable through the port cover.



**Note:** The feed hole will stretch to accommodate the RJ45 connector, and then seal around the cable.

7. Connect the Ethernet cable to the *Main* port and replace the port cover.

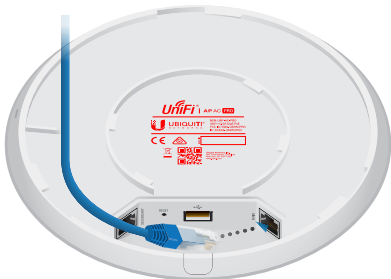

8. Align the *Notch* on the top edge of the UniFi AP with the *Arrow* on the *Mounting Bracket*.

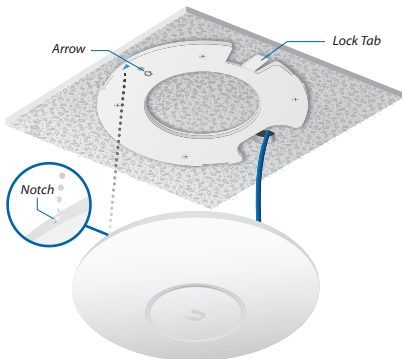

9. Rotate the UniFi AP clockwise until the tabs lock into place and the *Lock Tab* engages.



10. Set the ceiling tile back into place.

## Powering the UniFi AP

The UAP-AC-PRO features auto-sensing 802.3af/802.3at PoE support and can be powered by any of the following:

- Ubiquiti Networks UniFi Switch with PoE
- 802.3af/802.3at PoE+ compliant switch
- Ubiquiti Networks Gigabit PoE Adapter (48V, 0.5A)

The single-pack of the UAP-AC-PRO includes one *Gigabit PoE* adapter. For multi-pack units, PoE adapters or a UniFi Switch with PoE may be purchased separately.

## Connecting to a PoE Switch

Connect the Ethernet cable from the UniFi AP directly to a PoE port on the switch.





## Connecting to a PoE Adapter

1. Connect the Ethernet cable from the device to the **POE** port of the *Gigabit PoE* adapter.
2. Connect an Ethernet cable from your LAN to the **LAN** port of the *Gigabit PoE* adapter.
3. Connect the *Power Cord* to the adapter, and then plug the *Power Cord* into a power outlet.



## Mounting the PoE Adapter (Optional)

1. Remove the *PoE Mounting Bracket* from the adapter, place the bracket at the desired location, and mark the two holes.
2. Pre-drill the holes if necessary, and secure the bracket using two fasteners (not included).
3. Align the adapter's slots with the tabs of the *PoE Mounting Bracket*, and then slide the adapter down.

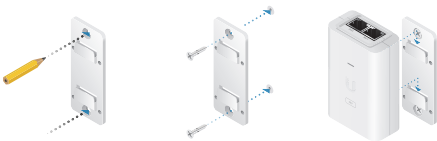

## Software Installation

Download and install the latest version of the UniFi Controller software. Launch it and follow the on-screen instructions. The software and step-by-step instructions in the User Guide are available at: [www.ubnt.com/download/unifi](http://www.ubnt.com/download/unifi)

After you have installed the software and run the UniFi Installation Wizard, a login screen will appear for the UniFi Controller management interface. Enter the Admin Name and Password that you created and click **Log In**.



You can manage your wireless network and view network statistics using the UniFi Controller management interface. For information on configuring and using the UniFi Controller software, refer to the User Guide.

## Mobile App Installation

Ubiquiti Networks also offers the UniFi mobile app, which is available from the App Store® (iOS) or Google Play™ Store (Android). You can use it to provision a UniFi AP for basic functionality without configuring a UniFi Controller. It also allows seamless provisioning of APs for remote controllers (controllers not on the same Layer 2 network) and easy access to local controllers and those monitored on [unifi.ubnt.com](http://unifi.ubnt.com)

## Specifications

UAP-AC-PRO	
Dimensions	196.7 x196.7 x 35 mm (7.74 x 7.74 x 1.38")
Weight with Mounting Kit	350 g (12.35 oz) 450 g (15.87 oz)
Networking Interface	(2) 10/100/1000 Ethernet Ports
Buttons	Reset
Power Method	PoE 802.3af/802.3at
Power Supply	48V, 0.5A Gigabit PoE Adapter*
Max. Power Consumption	9W
Operating Frequency	2.4 GHz 5 GHz
Max. TX Power 2.4 GHz 5 GHz	22 dBm 22 dBm
Antennas	(3) Dual-Band Antennas, 3 dBi each
Wi-Fi Standards	802.11 a/b/g/n/ac
Wireless Security	WEP, WPA-PSK, WPA-Enterprise (WPA/WPA2, TKIP/AES)
Mounting	Wall/Ceiling (Kits Included)
Operating Temperature	-10 to 70° C (14 to 158° F)
Operating Humidity	5 to 95% Noncondensing
Certifications	CE, FCC, IC

\* Included with the single-pack of the UAP-AC-PRO

## Safety Notices

1. Read, follow, and keep these instructions.
2. Heed all warnings.
3. Only use attachments/accessories specified by the manufacturer.



**WARNING:** Do not use this product in a location that can be submerged by water.



**WARNING:** Avoid using this product during an electrical storm. There may be a remote risk of electric shock from lightning.

## Electrical Safety Information

1. Compliance is required with respect to voltage, frequency, and current requirements indicated on the manufacturer's label. Connection to a different power source than those specified may result in improper operation, damage to the equipment or pose a fire hazard if the limitations are not followed.
2. There are no operator serviceable parts inside this equipment. Service should be provided only by a qualified service technician.
3. This equipment is provided with a detachable power cord which has an integral safety ground wire intended for connection to a grounded safety outlet.
  - a. Do not substitute the power cord with one that is not the provided approved type. Never use an adapter plug to connect to a 2-wire outlet as this will defeat the continuity of the grounding wire.
  - b. The equipment requires the use of the ground wire as a part of the safety certification, modification or misuse can provide a shock hazard that can result in serious injury or death.
  - c. Contact a qualified electrician or the manufacturer if there are questions about the installation prior to connecting the equipment.
  - d. Protective earthing is provided by Listed AC adapter. Building installation shall provide appropriate short-circuit backup protection.
  - e. Protective bonding must be installed in accordance with local national wiring rules and regulations.

## Limited Warranty

[www.ubnt.com/support/warranty/](http://www.ubnt.com/support/warranty/)

The limited warranty requires the use of arbitration to resolve disputes on an individual basis, and, where applicable, specify arbitration instead of jury trials or class actions.

## Compliance

### FCC

Changes or modifications not expressly approved by the party responsible for compliance could void the user's authority to operate the equipment.

This device complies with Part 15 of the FCC Rules. Operation is subject to the following two conditions.

1. This device may not cause harmful interference, and
2. This device must accept any interference received, including interference that may cause undesired operation.

This equipment has been tested and found to comply with the limits for a Class A digital device, pursuant to part 15 of the FCC Rules. These limits are designed to provide reasonable protection against harmful interference when the equipment is operated in a commercial environment. This equipment generates, uses, and can radiate radio frequency energy and, if not installed and used in accordance with the instruction manual, may cause harmful interference to radio communications. Operations of this equipment in a residential area is likely to cause harmful interference in which case the user will be required to correct the interference at his own expense.

This radio transmitter (FCC: SWX-UAPACPRO) has been approved by FCC.

## ISED Canada

### CAN ICES-3(A)/NMB-3(A)

This device complies with ISED Canada licence-exempt RSS standard(s). Operation is subject to the following two conditions:

1. This device may not cause interference, and
2. This device must accept any interference, including interference that may cause undesired operation of the device.

This radio transmitter (IC: 6545A-UAPACPRO) has been approved by ISED Canada.

### CAN ICES-3(A)/NMB-3(A)

Le présent appareil est conforme aux CNR d'ISDE Canada applicables aux appareils radio exempts de licence. L'exploitation est autorisée aux deux conditions suivantes :

1. l'appareil ne doit pas produire de brouillage;
2. l'appareil doit accepter tout brouillage radioélectrique subi, même si le brouillage est susceptible d'en compromettre le fonctionnement.

Le présent émetteur radio (IC : 6545A-UAPACPRO) a été approuvé par ISDE Canada.

## RF Exposure Warning

The antennas used for this transmitter must be installed to provide a separation distance of at least 20 cm from all persons and must not be located or operating in conjunction with any other antenna or transmitter, except as listed for this product's certification.

Les antennes utilisées pour cet émetteur doit être installé pour fournir une distance de séparation d'au moins 20 cm de toutes les personnes et ne doit pas être situé ou opérant en conjonction avec une autre antenne ou un autre émetteur, sauf dans les cas énumérés à la certification de ce produit.

## Australia and New Zealand



Warning: This is a Class A product. In a domestic environment this product may cause radio interference in which case the user may be required to take adequate measures.

## Brazil



**Nota:** Este equipamento não tem direito à proteção contra interferência prejudicial e não pode causar interferência em sistemas devidamente autorizados.

## CE Marking

CE marking on this product represents the product is in compliance with all directives that are applicable to it.



### Country List



AT	BE	BG	CY	CZ	DE	DK	EE	EL	ES	FI	FR	HR	HU
IE	IT	LV	LT	LU	MT	NL	PL	PT	RO	SE	SI	SK	UK

BFWA (Broadband Fixed Wireless Access) members noted in blue



**Note:** This device meets Max. TX power limit per ETSI regulations.

The following apply to products that operate in the 5 GHz frequency range:



**Note:** This device is restricted to indoor use only when operating in the 5150 - 5350 MHz frequency range within all member states.



**Note:** All countries listed may operate at 30 dBm. BFWA member states may operate at 36 dBm.



**Note:** Operation in the 5.8 GHz frequency band is prohibited in BFWA member states. Other countries listed may use the 5.8 GHz frequency band.

## RoHS/WEEE Compliance Statement



### English

European Directive 2012/19/EU requires that the equipment bearing this symbol on the product and/or its packaging must not be disposed of with unsorted municipal waste. The symbol indicates that this product should be disposed of separately from regular household waste streams. It is your responsibility to dispose of this and other electric and electronic equipment via designated collection facilities appointed by the government or local authorities. Correct disposal and recycling will help prevent potential negative consequences to the environment and human health. For more detailed information about the disposal of your old equipment, please contact your local authorities, waste disposal service, or the shop where you purchased the product.

### Deutsch

Die Europäische Richtlinie 2012/19/EU verlangt, dass technische Ausrüstung, die direkt am Gerät und/oder an der Verpackung mit diesem Symbol versehen ist, nicht zusammen mit unsortiertem Gemeindeabfall entsorgt werden darf. Das Symbol weist darauf hin, dass das Produkt von regulärem Haushaltsmüll getrennt entsorgt werden sollte. Es liegt in Ihrer Verantwortung, dieses Gerät und andere elektrische und elektronische Geräte über die dafür zuständigen und von der Regierung oder örtlichen Behörden dazu bestimmten Sammelstellen zu entsorgen. Ordnungsgemäßes Entsorgen und Recyceln trägt dazu bei, potentielle negative Folgen für Umwelt und die menschliche Gesundheit zu vermeiden. Wenn Sie weitere Informationen zur Entsorgung Ihrer Altgeräte benötigen, wenden Sie sich bitte an die örtlichen Behörden oder städtischen Entsorgungsdienste oder an den Händler, bei dem Sie das Produkt erworben haben.



## Español

La Directiva 2012/19/UE exige que los equipos que lleven este símbolo en el propio aparato y/o en su embalaje no deben eliminarse junto con otros residuos urbanos no seleccionados. El símbolo indica que el producto en cuestión debe separarse de los residuos domésticos convencionales con vistas a su eliminación. Es responsabilidad suya desechar este y cualesquiera otros aparatos eléctricos y electrónicos a través de los puntos de recogida que ponen a su disposición el gobierno y las autoridades locales. Al desechar y reciclar correctamente estos aparatos estará contribuyendo a evitar posibles consecuencias negativas para el medio ambiente y la salud de las personas. Si desea obtener información más detallada sobre la eliminación segura de su aparato usado, consulte a las autoridades locales, al servicio de recogida y eliminación de residuos de su zona o pregunte en la tienda donde adquirió el producto.

## Français

La directive européenne 2012/19/UE exige que l'équipement sur lequel est apposé ce symbole sur le produit et/ou son emballage ne soit pas jeté avec les autres ordures ménagères. Ce symbole indique que le produit doit être éliminé dans un circuit distinct de celui pour les déchets des ménages. Il est de votre responsabilité de jeter ce matériel ainsi que tout autre matériel électrique ou électronique par les moyens de collecte indiqués par le gouvernement et les pouvoirs publics des collectivités territoriales. L'élimination et le recyclage en bonne et due forme ont pour but de lutter contre l'impact néfaste potentiel de ce type de produits sur l'environnement et la santé publique. Pour plus d'informations sur le mode d'élimination de votre ancien équipement, veuillez prendre contact avec les pouvoirs publics locaux, le service de traitement des déchets, ou l'endroit où vous avez acheté le produit.

## Italiano

La direttiva europea 2012/19/UE richiede che le apparecchiature contrassegnate con questo simbolo sul prodotto e/o sull'imballaggio non siano smaltite insieme ai rifiuti urbani non differenziati. Il simbolo indica che questo prodotto non deve essere smaltito insieme ai normali rifiuti domestici. È responsabilità del proprietario smaltire sia questi prodotti sia le altre apparecchiature elettriche ed elettroniche mediante le specifiche strutture di raccolta indicate dal governo o dagli enti pubblici locali. Il corretto smaltimento ed il riciclaggio aiuteranno a prevenire conseguenze potenzialmente negative per l'ambiente e per la salute dell'essere umano. Per ricevere informazioni più dettagliate circa lo smaltimento delle vecchie apparecchiature in Vostro possesso, Vi invitiamo a contattare gli enti pubblici di competenza, il servizio di smaltimento rifiuti o il negozio nel quale avete acquistato il prodotto.

# Declaration of Conformity

**български [Bulgarian]** С настоящото UBIQUITI NETWORKS декларира, че този тип радиосъоръжение UAP-AC-PRO е в съответствие с Директива 2014/53/ЕС. Цялостният текст на ЕС декларацията за съответствие може да се намери на следния интернет адрес: [www.ubnt.com/compliance](http://www.ubnt.com/compliance)

**Hrvatski [Croatian]** UBIQUITI NETWORKS ovime izjavljuje da je radijska oprema tipa UAP-AC-PRO u skladu s Direktivom 2014/53/EU. Cjeloviti tekst EU izjave o sukladnosti dostupan je na sljedećoj internetskoj adresi: [www.ubnt.com/compliance](http://www.ubnt.com/compliance)

**Čeština [Czech]** Tímto UBIQUITI NETWORKS prohlašuje, že typ rádiového zařízení UAP-AC-PRO je v souladu se směrnicí 2014/53/EU. Úplné znění EU prohlášení o shodě je k dispozici na této internetové adrese: [www.ubnt.com/compliance](http://www.ubnt.com/compliance)

**Dansk [Danish]** Hermed erklærer UBIQUITI NETWORKS, at radioudstyrstypen UAP-AC-PRO er i overensstemmelse med direktiv 2014/53/EU. EU-overensstemmelseserklæringens fulde tekst kan findes på følgende internetadresse: [www.ubnt.com/compliance](http://www.ubnt.com/compliance)

**Nederlands [Dutch]** Hierbij verklaar ik, UBIQUITI NETWORKS, dat het type radioapparatuur UAP-AC-PRO conform is met Richtlijn 2014/53/EU. De volledige tekst van de EU-conformiteitsverklaring kan worden geraadpleegd op het volgende internetadres: [www.ubnt.com/compliance](http://www.ubnt.com/compliance)

**English** Hereby, UBIQUITI NETWORKS declares that the radio equipment type UAP-AC-PRO is in compliance with Directive 2014/53/EU. The full text of the EU declaration of conformity is available at the following internet address: [www.ubnt.com/compliance](http://www.ubnt.com/compliance)

**Eesti keel [Estonian]** Käesolevaga deklareerib UBIQUITI NETWORKS, et käesolev raadioseadme tüüp UAP-AC-PRO vastab direktiivi 2014/53/EL nõuetele. ELi vastavusdeklaratsiooni täielik tekst on kättesaadav järgmisel internetiaadressil: [www.ubnt.com/compliance](http://www.ubnt.com/compliance)

**Suomi [Finnish]** UBIQUITI NETWORKS vakuuttaa, että radiolaitetyypin UAP-AC-PRO on direktiivin 2014/53/EU mukainen. EU-vaatimustenmukaisuusvakuutuksen täysimittainen teksti on saatavilla seuraavassa internetosoitteessa: [www.ubnt.com/compliance](http://www.ubnt.com/compliance)

**Français [French]** Le soussigné, UBIQUITI NETWORKS, déclare que l'équipement radioélectrique du type UAP-AC-PRO est conforme à la directive 2014/53/UE. Le texte complet de la déclaration UE de conformité est disponible à l'adresse internet suivante: [www.ubnt.com/compliance](http://www.ubnt.com/compliance)

**Deutsch [German]** Hiermit erklärt UBIQUITI NETWORKS, dass der Funkanlagentyp UAP-AC-PRO der Richtlinie 2014/53/EU entspricht. Der vollständige Text der EU-Konformitätserklärung ist unter der folgenden Internetadresse verfügbar: [www.ubnt.com/compliance](http://www.ubnt.com/compliance)

**Ελληνικά [Greek]** Με την παρούσα ο/η UBIQUITI NETWORKS, δηλώνει ότι ο ραδιοεξοπλισμός UAP-AC-PRO πληροί την οδηγία 2014/53/ΕΕ. Το πλήρες κείμενο της δήλωσης συμμόρφωσης ΕΕ διατίθεται στην ακόλουθη ιστοσελίδα στο διαδίκτυο: [www.ubnt.com/compliance](http://www.ubnt.com/compliance)

**Magyar [Hungarian]** UBIQUITI NETWORKS igazolja, hogy a UAP-AC-PRO típusú rádióberendezés megfelel a 2014/53/EU irányelvnek. Az EU-megfelelőségi nyilatkozat teljes szövege elérhető a következő internetes címen: [www.ubnt.com/compliance](http://www.ubnt.com/compliance)

**Íslenska [Icelandic]** Hér með lýsir UBIQUITI NETWORKS yfir því að UAP-AC-PRO er í samræmi við grunnkröfur og aðrar kröfur, sem gerðar eru í tilskipun 2014/53/EU. Fullur texti ESB samræmisýfirlýsing er að finna á eftirfarandi netfangi: [www.ubnt.com/compliance](http://www.ubnt.com/compliance)

**Italiano [Italian]** Il fabbricante, UBIQUITI NETWORKS, dichiara che il tipo di apparecchiatura radio UAP-AC-PRO è conforme alla direttiva 2014/53/UE. Il testo completo della dichiarazione di conformità UE è disponibile al seguente indirizzo Internet: [www.ubnt.com/compliance](http://www.ubnt.com/compliance)

**Latviešu valoda [Latvian]** Ar šo UBIQUITI NETWORKS deklarē, ka radioiekārta UAP-AC-PRO atbilst Direktīvai 2014/53/ES. Pilns ES atbilstības deklarācijas teksts ir pieejams šādā interneta vietnē: [www.ubnt.com/compliance](http://www.ubnt.com/compliance)

**Lietuvių kalba [Lithuanian]** Aš, UBIQUITI NETWORKS, patvirtinu, kad radijo įrenginių tipas UAP-AC-PRO atitinka Direktyvą 2014/53/ES. Visas ES atitikties deklaracijos tekstas prieinamas šiuo interneto adresu: [www.ubnt.com/compliance](http://www.ubnt.com/compliance)

**Malti [Maltese]** B'dan, UBIQUITI NETWORKS, niddikjara li dan it-tip ta' tagħmir tar-radju UAP-AC-PRO huwa konformi mad-Direttiva 2014/53/UE. Id-dikjarazzjoni tal-konformità tista' tiġi kkonsultata minn [www.ubnt.com/compliance](http://www.ubnt.com/compliance)

**Norsk [Norwegian]** UBIQUITI NETWORKS erklærer herved at utstyret UAP-AC-PRO er i samsvar med de grunnleggende krav og øvrige relevante krav i direktiv 2014/53/EU. Den fulle teksten til EU-samsvarserklæringen er tilgjengelig på følgende internetadresse: [www.ubnt.com/compliance](http://www.ubnt.com/compliance)

**Polski [Polish]** UBIQUITI NETWORKS niniejszym oświadcza, że typ urządzenia radiowego UAP-AC-PRO jest zgodny z dyrektywą 2014/53/UE. Pełny tekst deklaracji zgodności UE jest dostępny pod następującym adresem internetowym: [www.ubnt.com/compliance](http://www.ubnt.com/compliance)

**Português [Portuguese]** O(a) abaixo assinado(a) UBIQUITI NETWORKS declara que o presente tipo de equipamento de rádio UAP-AC-PRO está em conformidade com a Diretiva 2014/53/UE. O texto integral da declaração de conformidade está disponível no seguinte endereço de Internet: [www.ubnt.com/compliance](http://www.ubnt.com/compliance)

**Română [Romanian]** Prin prezenta, UBIQUITI NETWORKS declară că tipul de echipamente radio UAP-AC-PRO este în conformitate cu Directiva 2014/53/UE. Textul integral al declarației UE de conformitate este disponibil la următoarea adresă internet: [www.ubnt.com/compliance](http://www.ubnt.com/compliance)

**Slovenčina [Slovak]** UBIQUITI NETWORKS týmto vyhlasuje, že rádiové zariadenie typu UAP-AC-PRO je v súlade so smernicou 2014/53/EÚ. Úplné EÚ vyhlásenie o zhode je k dispozícii na tejto internetovej adrese: [www.ubnt.com/compliance](http://www.ubnt.com/compliance)

**Slovenščina [Slovenian]** UBIQUITI NETWORKS potrjuje, da je tip radijske opreme UAP-AC-PRO skladen z Direktivo 2014/53/EU. Celotno besedilo izjave EU o skladnosti je na voljo na naslednjem spletnem naslovu: [www.ubnt.com/compliance](http://www.ubnt.com/compliance)

**Español [Spanish]** Por la presente, UBIQUITI NETWORKS declara que el tipo de equipo radioeléctrico UAP-AC-PRO es conforme con la Directiva 2014/53/UE. El texto completo de la declaración UE de conformidad está disponible en la dirección Internet siguiente: [www.ubnt.com/compliance](http://www.ubnt.com/compliance)

**Svenska [Swedish]** Härmed försäkrar UBIQUITI NETWORKS att denna typ av radioutrustning UAP-AC-PRO överensstämmer med direktiv 2014/53/EU. Den fullständiga texten till EU-försäkran om överensstämmelse finns på följande webbadress: [www.ubnt.com/compliance](http://www.ubnt.com/compliance)



## Online Resources

Support [help.ubnt.com](http://help.ubnt.com)

Community [community.ubnt.com](http://community.ubnt.com)

Downloads [downloads.ubnt.com](http://downloads.ubnt.com)

Ubiquiti Networks, Inc.  
685 Third Avenue, 27th Floor  
New York, NY 10017  
USA



[www.ubnt.com](http://www.ubnt.com)

©2016-2018 Ubiquiti Networks, Inc. All rights reserved. Ubiquiti, Ubiquiti Networks, the Ubiquiti U logo, the Ubiquiti beam logo, TOUGHCable, and UniFi are trademarks or registered trademarks of Ubiquiti Networks, Inc. in the United States and in other countries. Apple and the Apple logo are trademarks of Apple Inc., registered in the U.S. and other countries. App Store is a service mark of Apple Inc., registered in the U.S. and other countries. Android, Google, Google Play, the Google Play logo and other marks are trademarks of Google Inc. All other trademarks are the property of their respective owners.

JLNB103118