

# Operator's Manual

**INSTASLICE™**  
Series 15100  
15200



Thank you for purchasing this Vollrath Food Processing Equipment. Before operating the equipment, read and familiarize yourself with the following operating and safety instructions. **SAVE THESE INSTRUCTIONS FOR FUTURE REFERENCE.** Save the original box and packaging. Use this packaging to ship the equipment if repairs are needed.

## SAFETY PRECAUTIONS

To ensure safe operation, read the following statements and understand their meaning. This manual contains safety precautions which are explained below. Please read carefully.

### WARNING

Warning is used to indicate the presence of a hazard that can cause severe personal injury, death, or substantial property damage if the warning is ignored.

### CAUTION

Caution is used to indicate the presence of a hazard that will or can cause minor personal injury or property damage if the caution is ignored.

### NOTE

Note is used to notify people of installation, operation, or maintenance information that is important but not hazard-related.

### For Your Safety!

These precautions should be followed at all times. Failure to follow these precautions could result in injury to yourself and others or damage the equipment.

To reduce risk of injury or damage to the equipment:

To reduce risk of injury or damage to the equipment:

- Check equipment before each use to insure the equipment is clean.
- Check for broken, nicked or dull blades and if found, replace blade assembly.
- Check to insure that the pusher head sits down completely on the rubber bumpers. The suction cups on each rear leg will hold the equipment securely to smooth surfaces.
- If necessary, lubricate guide rods using a light coating of mineral oil, Petro Gel, or food grade lubricant. **DO NOT USE COOKING OIL AS IT WILL BECOME STICKY AND MAY PERMANENTLY DAMAGE THE PUSHER HEAD BEARINGS**

## FUNCTION AND PURPOSE

Intended for slicing of tomatoes.

## OPERATION

	<b>WARNING</b>
	<b>Sharp Blade Hazard.</b> Blades are sharp and can cause cuts and amputation.
To avoid injury from sharp blades, handle with caution. Only trained personal should operate equipment or preform maintenance.	

Prior to first use, it is important to clean the equipment. Wash new blades with warm soapy water and rinse thoroughly to remove the thin protective oil film.

1. Place slicer on a table or counter. Position the InstaSlice Table Stop over a table edge to hold the equipment in place
2. Before each use, always check for proper blade tightness and equipment cleanliness. Check for broken, nicked or dull blades and if found, replace blade assembly.
3. This equipment should be used to slice soft vegetables such as tomatoes, mushrooms, strawberries, etc. Hard foods such as onions, potatoes, lemons, etc. will cause blades to break. Use a Tomato King Scooper to remove the stem scar of the tomato. For best results, the tomatoes should be clean and wet before slicing them in the equipment.
4. Spray the plastic platform and blades with water to reduce friction and repeat as needed during use.
5. Place the tomato top down on the platform of the slicer against the pusher head. Place one hand on the pusher head handle and one hand on the knob on top of the slicer. With a quick push of the pusher head, push the tomato through the blades catching the slices into a pan placed at the end of the slicer.
6. Repeat this process until you have prepared enough food for your daily needs.
7. Rinse blades immediately. Failure to do so will shorten the life of the blades.

## CLEANING

	<b>WARNING</b>
	<b>Sharp Blade Hazard.</b> Blades are sharp and can cause cuts and amputation.
To avoid injury from sharp blades, handle with caution. Only trained personal should operate equipment or preform maintenance.	

To maintain the appearance and increase the service life, clean your daily.

1. Place Pusher Head Assembly in its most "open" position by retracting the handle.
2. Rinse or spray off equipment thoroughly with HOT water. You may want to immerse the complete equipment in warm soapy water first. Use caution when handling the equipment - blades are sharp.
3. Do not wipe across blades or use scrub pads on this equipment. Wiping across the sharp edge of the blade can cause injury and will dull the blades.
4. Do not put this equipment in a dishwasher or dish machine with soaps, detergents, or other alkaline chemicals that can harm the equipment.
5. After cleaning, let the equipment air dry.
6. Lubricate sliding parts with mineral oil or Petro Gel after each use. Do not use cooking oil as it will become sticky and may permanently damage the equipment.

### NOTE:

**Food acids will make blades dull and corrode the metal. Always clean this food preparation equipment immediately after every use.**

## BLADE AND PUSHER HEAD MAINTENANCE

1. Examine the pusher head fingers. If they are nicked or burred, smooth the rough edges with a small flat file. The spaces between the fingers must be uniform. Straighten any bent fingers.
2. Check the clearance between the pusher head fingers and the blades. Make sure they do not rest on or touch the blades at any point when you move the head through its full travel. If there is contact, adjustments must be made. Pusher head fingers must never contact blades.
3. Adjust pusher head finger spacing by placing a screwdriver between pusher head fingers and gently rotate up/down. You may also adjust the entire pusher head assembly by loosening the set screws underneath and rotating the guide rod as needed - tighten set screws.

## PREVENTATIVE MAINTENANCE

4. Clean the equipment after every use.
5. Use for intended purposes only.
6. Change the blades regularly - based on usage.

## TROUBLESHOOTING

If the equipment no longer slices tomatoes cleanly or without damage to the tomato, the blades could be dull and be in need of replacement. Broken, bent, or nicked blades must be replaced immediately.

Problem	It might be caused by	Course of Action
Broken Blade.	Wrong food used in equipment.	Slice only what is recommended.
Fingers are misaligned.		Readjust fingers.
Blades are dull.		Replace blade assembly as needed.

## REPLACING BLADE ASSEMBLY

	<b>WARNING</b>
	<b>Sharp Blade Hazard.</b> Blades are sharp and can cause cuts and amputation.
To avoid injury from sharp blades, handle with caution. Only trained personal should operate equipment or perform maintenance.	

Individual blades cannot be replaced. Replacement blades are available in assemblies only.

The notches on the blade assembly fit in grooves on the bottom front of the frame.

1. Loosen the two thumbscrews on the top of the equipment.
2. Push the top of the blade assembly from the back towards the front and lift out. Replace in the opposite manner and tighten the two thumbscrews.
3. Dispose of used blade assemblies properly.

LETTER	PART #	DESCRIPTION
A	369211	Thumb screw
B	0304	Knob
C	379064	Bridge casting
D	15112	Blade assembly, 7/32" (scalloped blade)
	15113	Blade assembly, 1/4" (scalloped blade)
	15115	Blade assembly, 3/16" (scalloped blade)
	15114	Blade assembly, 3/8" (scalloped blade)
	15206	Blade assembly, 7/32" (straight blade)
	15207	Blade assembly, 1/4" (straight blade)
	15209	Blade assembly, 3/16" (straight blade)
15208	Blade assembly, 3/8" (straight blade)	
E	379069	Pusher head assembly bolt

LETTER	PART #	DESCRIPTION
F	379070	Pusher head assembly (complete) 7/32"
	379071	Pusher head assembly (complete) 1/4"
	379072	Pusher head assembly (complete) 3/16" & 3/8"
G	379073	Shoulder bolt
H	379074	Handle assembly
I	379075	Guide rod (long)
J	379076	Table top
K	379049	RUBBER washer - guide rod
L	379077	Guide rod (short)
M	353	Nut - guide rod
N	2319	Rubber foot
O	379079	Base
Not Shown	379065	Guard

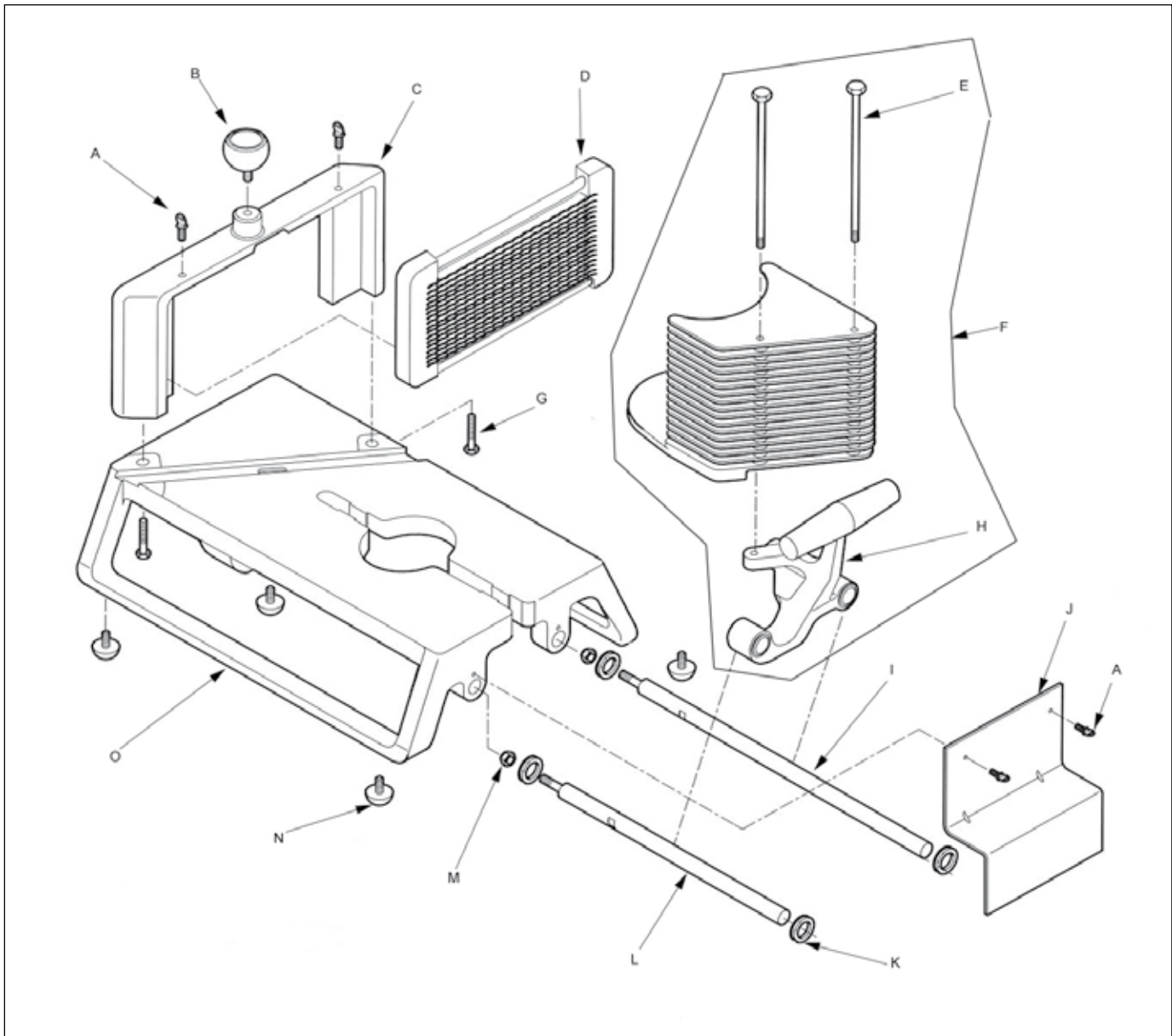



---

## **SERVICE AND REPAIR**

---

Serviceable parts are available on [Vollrath.com](http://Vollrath.com).

To avoid serious injury or damage, never attempt to repair the unit or replace a damaged power cord yourself. Do not send units directly to The Vollrath Company LLC. Please contact Vollrath Technical Services for instructions.

When contacting Vollrath Technical Services, please be ready with the item number, model number (if applicable), serial number, and proof of purchase showing the date the unit was purchased.

---

## **WARRANTY STATEMENT FOR THE VOLLRATH CO. L.L.C.**

---

This warranty does not apply to products purchased for personal, family or household use, and The Vollrath Company LLC does not offer a written warranty to purchasers for such uses.

The Vollrath Company LLC warrants the products it manufactures or distributes against defects in materials and workmanship as specifically described in our full warranty statement. In all cases, the warranty runs from the date of the end user's original purchase date found on the receipt. Any damages from improper use, abuse, modification or damage resulting from improper packaging during return shipment for warranty repair will not be covered under warranty.

For complete warranty information, product registration and new product announcement, visit [www.vollrath.com](http://www.vollrath.com).

# Installation Instructions

## InstaSlice™ Pusher Head Replacement

To ensure safe installation and operation, read the following statements and understand their meaning. Please read carefully.

**WARNING**

Warning is used to indicate the presence of a hazard that *can* cause severe personal injury, death, or substantial property damage if the warning is ignored.

**SAFETY PRECAUTIONS**

	<p><b>WARNING</b></p>
<p><b>Sharp Blade Hazard.</b> Blades are sharp and can cause cuts and amputation.</p>	
<p>To avoid injury from sharp blades, handle with caution. Only trained personal should operate equipment or preform maintenance.</p>	

**INSTALLATION PROCEDURES**

1. Slide the pusher head assembly (A) out and away from the blade assembly (D). See Figure 1.

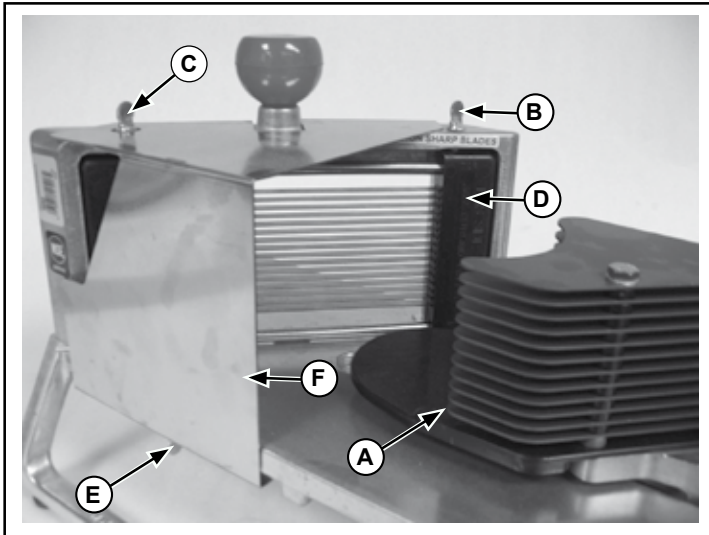

Figure 1. Blade Assembly and Guard Removal and Installation

2. Loosen the thumb screws (B and C) and carefully remove the blade assembly (D).
3. Remove the thumb screws (C and E) and the guard (F).

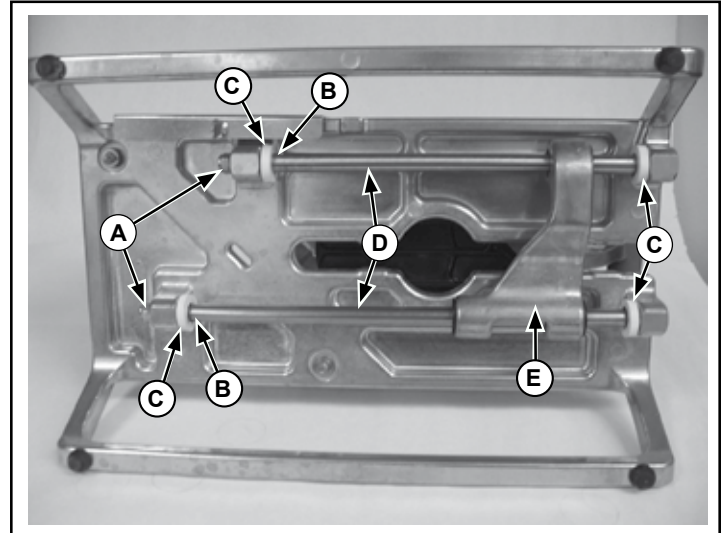

Figure 2. Guide Rod, Nylock Nut and Washer Removal and Installation

4. Hold guide the rods (D) using a wrench on the flats (B) and remove the nylock nuts (A). See Figure 2.
5. Note the position and location of the washers (C) and orientation of the pusher head assembly (E). Slowly remove the guide rods (D) and washers (C).
6. Retain the nylock nuts (A) for reuse. Retain the washers (C) if they are going to be reused or discard if they are going to be replaced.

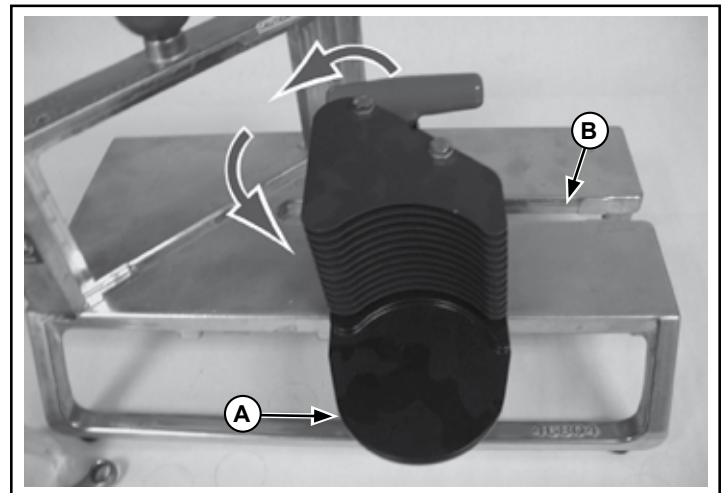
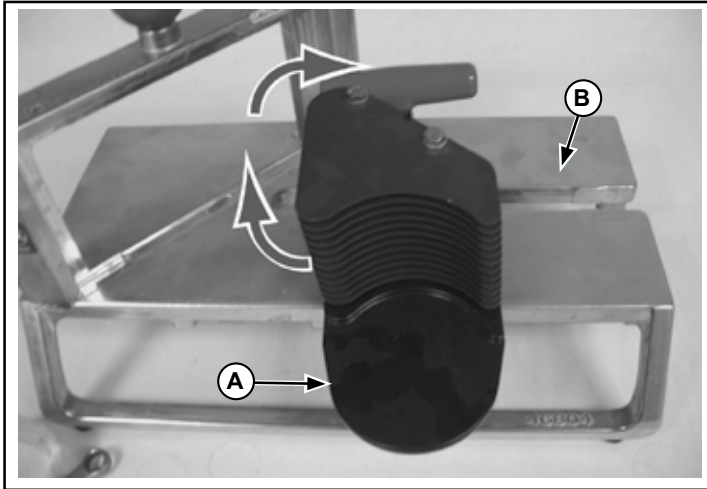

Figure 3. Pusher Head Assembly Removal

7. Rotate the pusher head (A) and remove by sliding out through slot (B). See Figure 3. Discard the old pusher head assembly.
8. Thoroughly wash the new pusher head assembly with hot and soapy water. Rinse thoroughly and allow to completely air dry. Use caution not to bend or damage the pusher fingers.



- Slide the new pusher head (A) handle first into the slot (B) and rotate until it is in the operating direction. See Figure 4.



**Figure 4. Installation of Pusher Head**

- Install the guide rods (D) by sliding through bumpers (C) and pusher head (E) as shown in figure 2.
- Secure the guide rods (D) using the nylock nuts (A) removed earlier.
- Lubricate sliding parts with mineral oil or Petro Gel. Do not use cooking oil as it will become sticky and may permanently damage the equipment.
- Slide the pusher head back and forth on the guide rods.
- Slide the pusher head away from the slicing area.
- Install the blade assembly (D) securing with thumb screws (B and C). See Figure 1.
- Slowly slide the pusher head toward the blade assembly paying close attention to any blade and pusher head contact.

If the pusher head (A) slides through the blade assembly (D) without making contact with the blades:

- Reinstall the guard (F) securing with thumb screws (C and E). Your InstaSlice™ is now ready to use. See Figure 1.

If the pusher head (A) makes contact with the blades it will be necessary to change the position of the pusher fingers by:

- Note which pusher finger(s) (A) are making contact (C) with the blades (B). See Figure 5. See Figure 1.

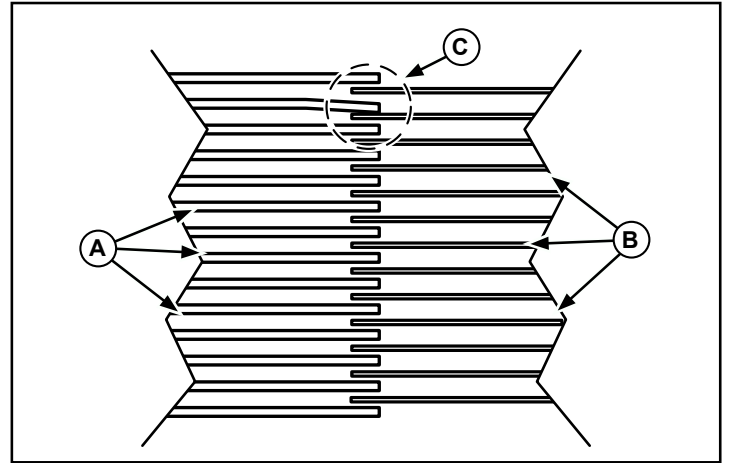

**Figure 5. Pusher Head Fingers and Blade Assembly**

- Hold a thin flat tool (B) on the pusher finger(s) that require adjustment. Tap the tool (B) with a mallet or similar tool. Use caution not to disrupt or make contact with another finger or to scratch the anodized surface of the pusher fingers. See Figure 6.

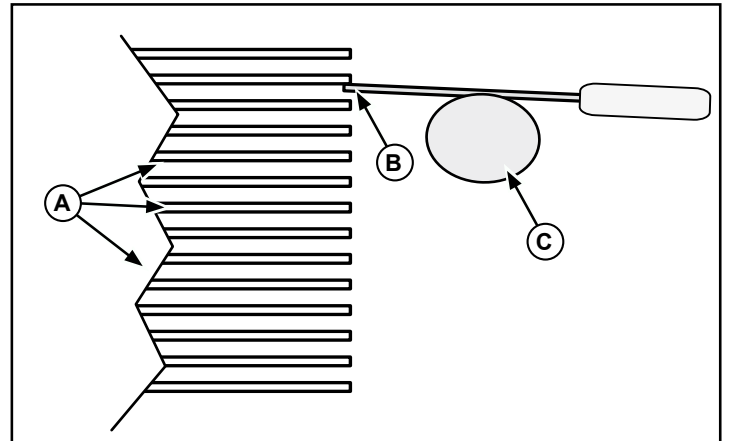

**Figure 6. Adjusting the Pusher Head Fingers**

- Slowly slide the pusher head toward the blade assembly paying close attention to any blade and pusher head contact. If the pusher head makes contact with the blades repeat previous steps 1 and 2.

Once the pusher head (A) slides through the blade assembly (D) without making contact with the blades:

- Reinstall the guard (F) securing with thumb screws (C and D). Your InstaSlice™ is now ready to use.