

Support spécial store

**pour caisson de volet roulant à rainure en partie supérieure jusqu'à 45 mm en retrait de la face avant.
Pour coffre sans rainure, utiliser la cale.**

1 Positionner et préregler le support

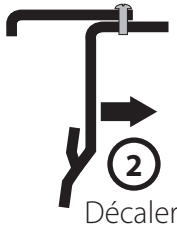
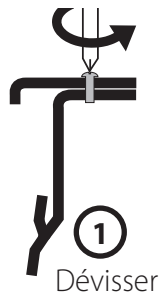
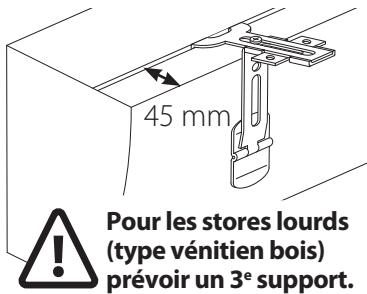

A Positionner le support dans la rainure

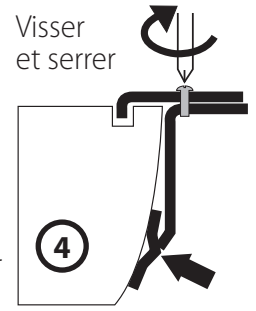
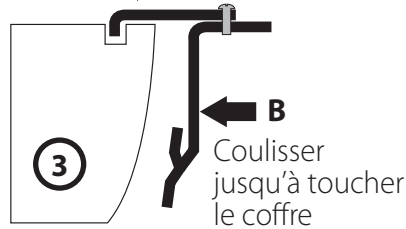

2 Fixer le support de pose fourni avec le store, sur le support

2 x M4x10mm



2 x M4x8mm



3 x M4x6mm



vis déjà montées sur le support

STORE VÉNITIEN PVC

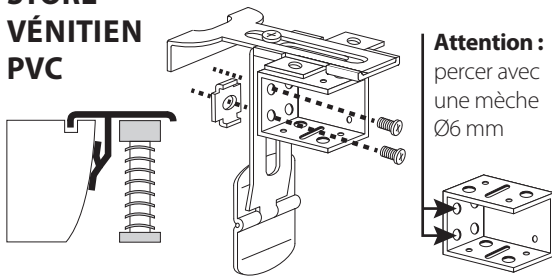

STORE VÉNITIEN ALU

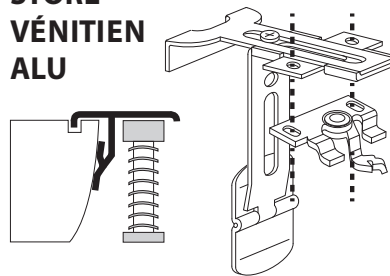

STORE ENROULEUR

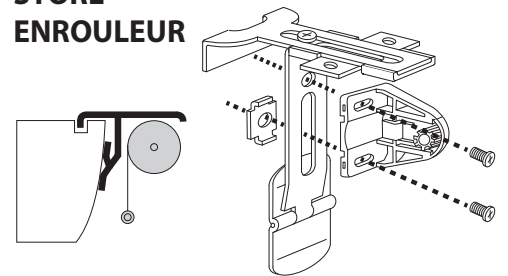

STORE ENROULEUR jour/nuit

1. Couper la partie haute de la pièce A

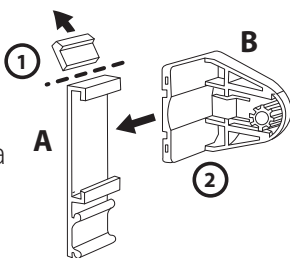

2. Emboîter la pièce B dans la pièce A

3. Percer la pièce A Ø5 mm à travers les lumières de la pièce B

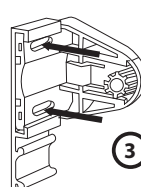

4. Assembler

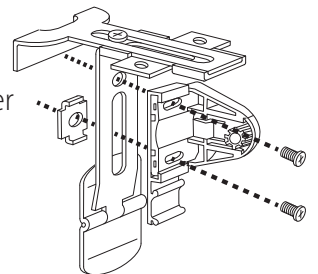

3 Retirer les films protecteurs des adhésifs à l'arrière de la platine amovible

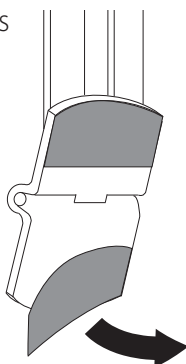

4 Fixer le store sur les supports

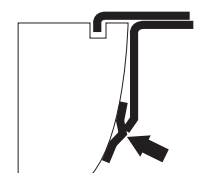
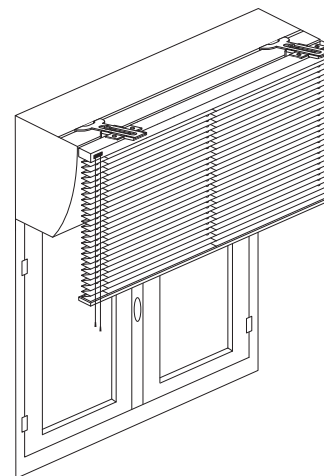
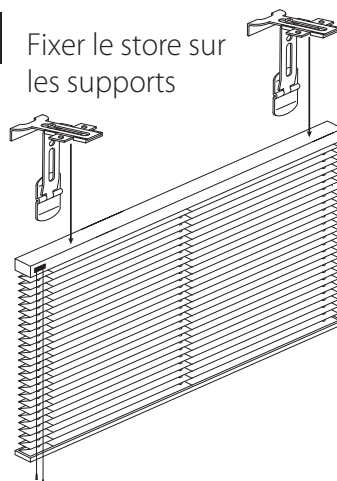

Positionner les supports dans la rainure et appuyer sur les platines amovibles