

ADB-19 Installation

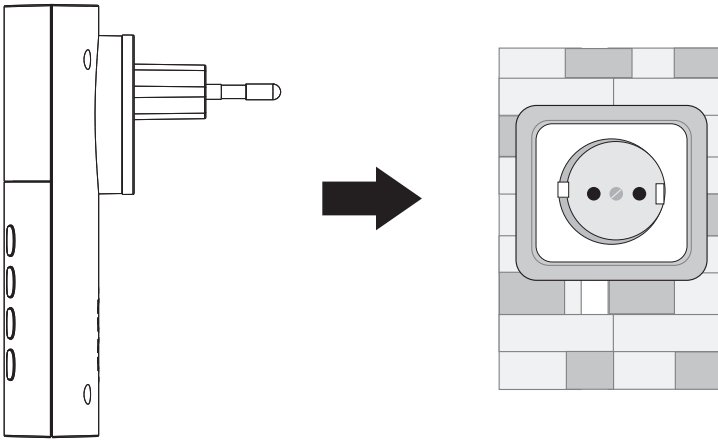

Indoor-unit:



Outdoor-unit - battery placement:

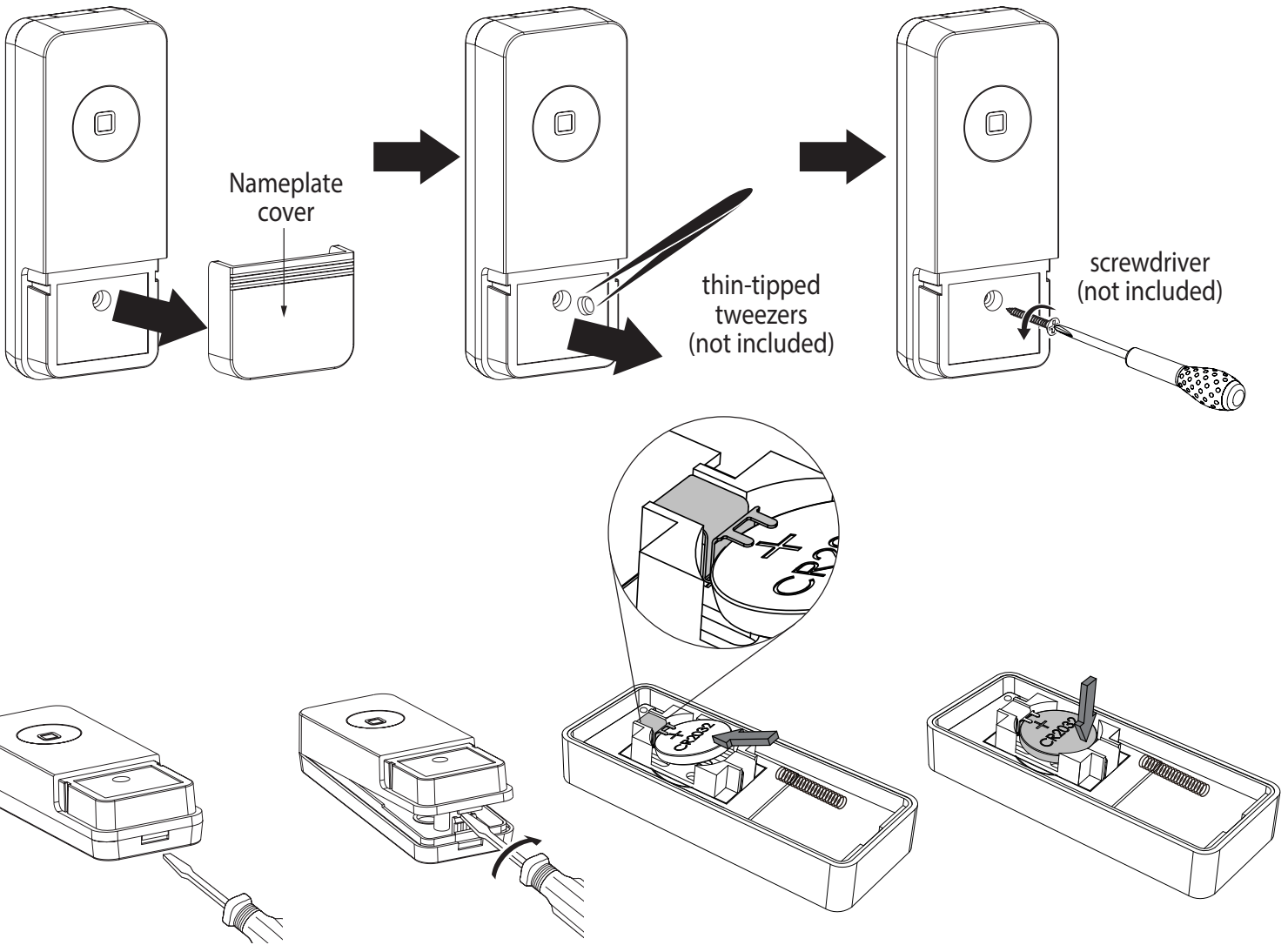

Connecting:

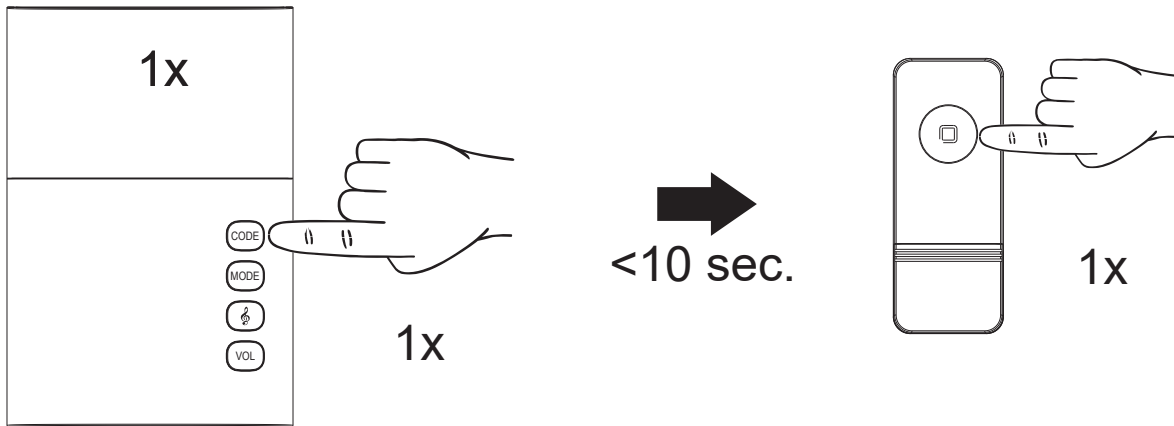

Lamp / Ring / Lamp & Ring:

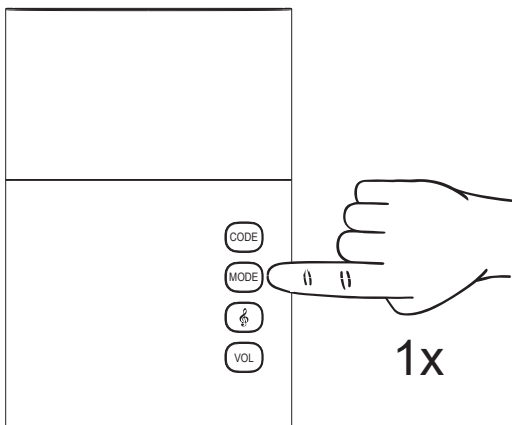

Unregister:

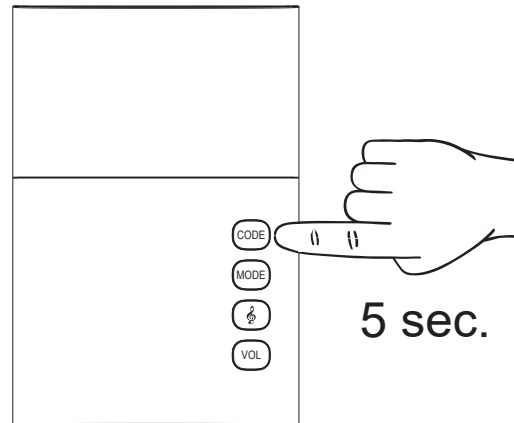

Change melody:

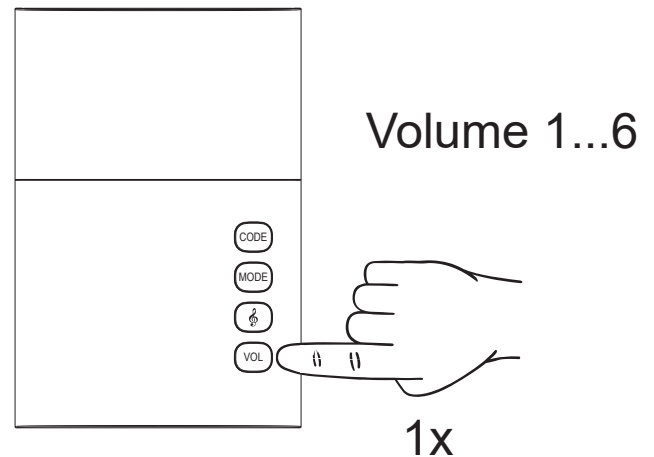
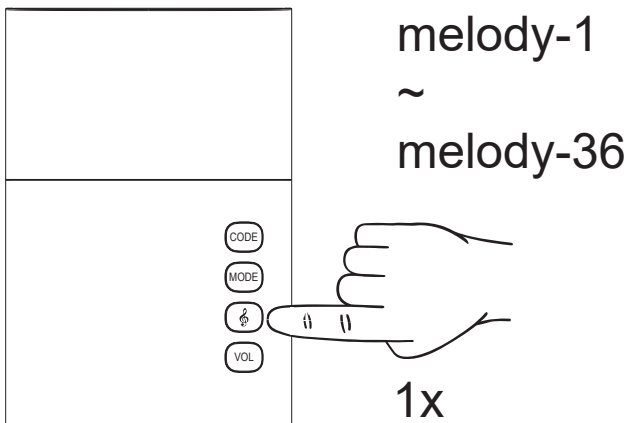

Frequency: 433MHz ASK
Transmission power: <10mW

EU-CONFORMITEITSVERKLARING

Hierbij verklaar ik, Commaxx, dat het type radioapparatuur ADB-19 conform is met Richtlijn 2014/53/EU. De volledige tekst van de EU-conformiteitsverklaring kan worden geraadpleegd op het volgende internetadres: <http://DOC.hesdo.com/ADB-19-DOC.pdf>

DECLARATION DE CONFORMITE

Le soussigné, Commaxx, déclare que l'équipement radioélectrique du type ADB-19 est conforme à la directive 2014/53/UE. Le texte complet de la déclaration UE de conformité est disponible à l'adresse internet suivante: <http://DOC.hesdo.com/ADB-19-DOC.pdf>

ÜBEREINSTIMMUNGSERKLÄRUNG

Hiermit erklärt Commaxx, dass der Funkanlagentyp ADB-19 der Richtlinie 2014/53/EU entspricht. Der vollständige Text der EU-Konformitätsverklärung ist unter der folgenden Internetadresse verfügbar: <http://DOC.hesdo.com/ADB-19-DOC.pdf>

EU DECLARATION OF CONFORMITY

Hereby, Commaxx declares that the radio equipment type ADB-19 is in compliance with Directive 2014/53/EU. The full text of the EU declaration of conformity is available at the following internet address: <http://DOC.hesdo.com/ADB-19-DOC.pdf>

Service 		 HSC	WWW.ALECTO.NL SERVICE@ALECTO.NL	
Help 			Commaxx B.V., Wiebachstraat 37, 6466 NG Kerkrade, The Netherlands	